

# FLOOR PLANS OF RESIDENTIAL PROPERTIES IN THE DEVELOPMENT

## 發展項目的住宅物業的樓面平面圖

17L Shouson Hill Road

壽山村道17L號

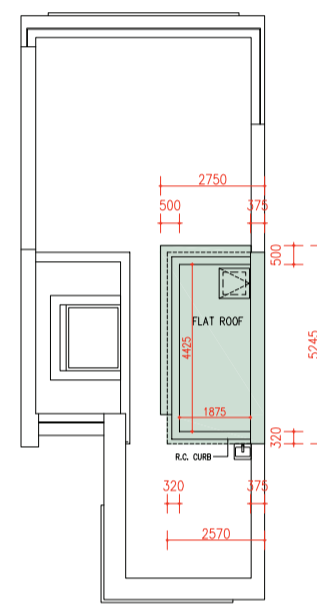
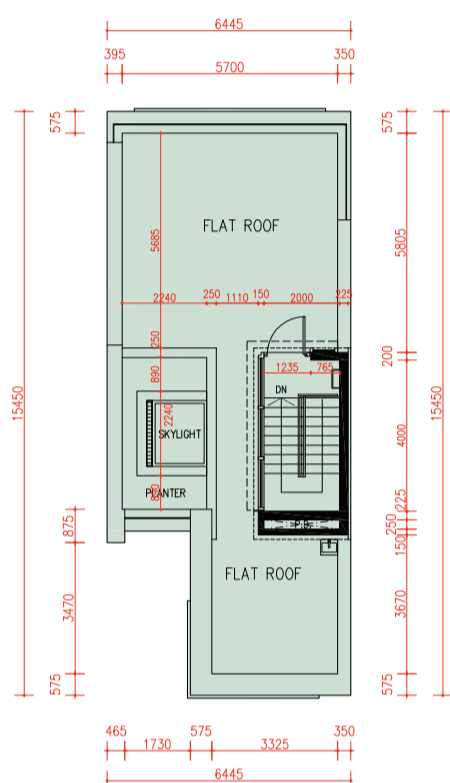

**Roof Plan**  
天台平面圖

**Upper Roof Plan**  
上層天台平面圖

scale 0 5 10M (米)  
比例

Floor 樓層	The thickness of the floor slabs (excluding plaster) of each house (mm) 每座洋房的樓板(不包括灰泥)的厚度(毫米)	The floor-to-floor height of each house (mm) 每座洋房的層與層之間的高度(毫米)
LG/F 地下低層	200	6750
G/F 地下	175, 200, 250	4500
1/F 一樓	150, 175	4000
2/F 二樓	200, 225	4000
Roof 天台	150	2400

The internal areas of the houses on the upper floors will generally be slightly larger than those on the lower floors because of the reducing thickness of the structural walls on the upper floors. 因洋房的較高樓層的結構牆的厚度遞減，較高樓層的內部面積，一般比較低樓層的內部面積稍大。

Note:

- The dimensions of floor plans are all structural dimensions in millimeter.
- There may be architectural features and/or exposed pipes on external walls of some houses. For details, please refer to the latest approved building plans.
- Common pipes exposed and/or enclosed in cladding are located at/adjacent to flat roof and/or external wall of some houses. For details, please refer to the latest approved building plans and/or electrical and mechanical design drawings.
- There are ceiling bulkheads and/or sunken slab of the above houses at living/dining room, bedrooms, corridors and/or kitchen of the above houses for the air-conditioning system and/or M&E services.
- Please refer to page AL1 of this sales brochure for legend of the terms and abbreviations shown in the floor plan above.
- Floor-to-floor height refers to the height between the top surface of the structural slab of a floor and the top surface of the structural slab of its immediate upper floor.

備註:

- 平面圖所列之尺寸數字為以毫米標示之建築結構尺寸。
- 部份洋房外牆設有建築裝飾及/或外露喉管。詳細資料請參考最新批准之建築圖則。
- 部份洋房的平台及/或外牆設有外露及/或外牆裝飾板內藏之公用喉管。詳細資料請參考最新批准的建築圖則及/或機電設計圖。
- 部份洋房客/飯廳、睡房、走廊及/或廚房有假天花及/或有跌級樓板以內藏冷氣系統及/或機電設備。
- 以上平面圖中顯示之名詞及簡稱請參閱本售樓說明書第 AL1 頁。
- 層與層之間的高度指該樓層之石屎地台面與上一層石屎地台面之高度距離。

# FLOOR PLANS OF RESIDENTIAL PROPERTIES IN THE DEVELOPMENT

## 發展項目的住宅物業的樓面平面圖

17M Shouson Hill Road

壽山村道17M號

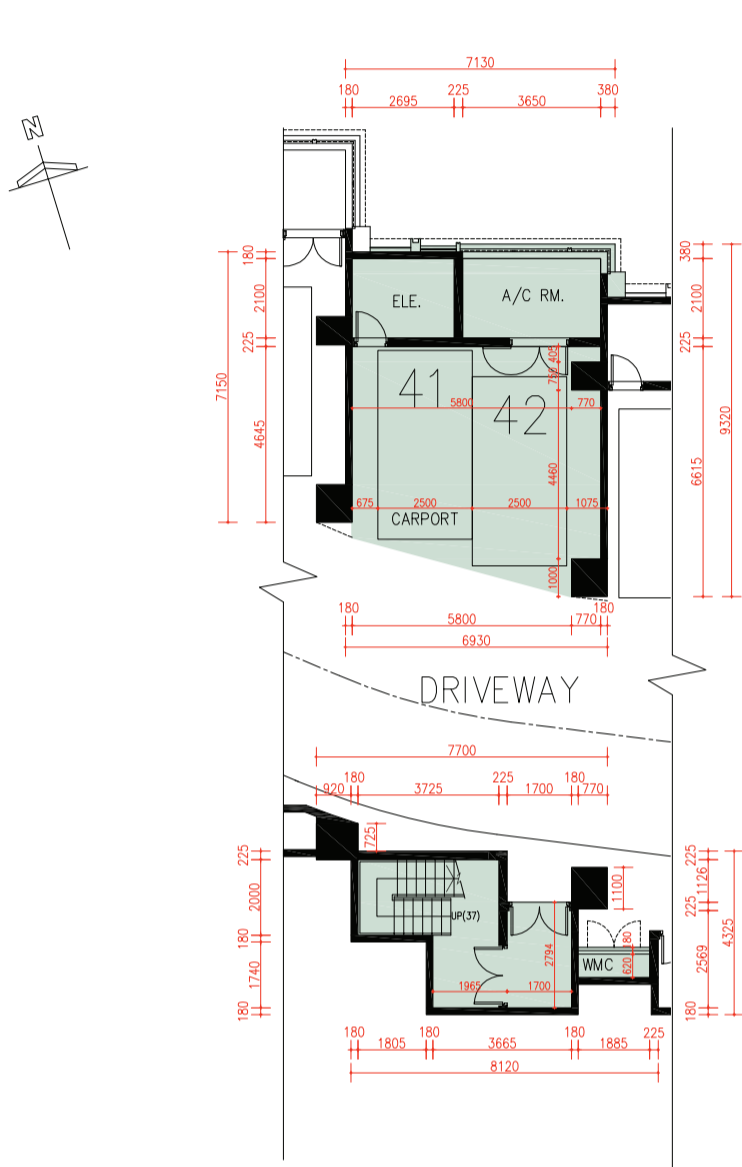

LG/F Plan  
地下低層平面圖

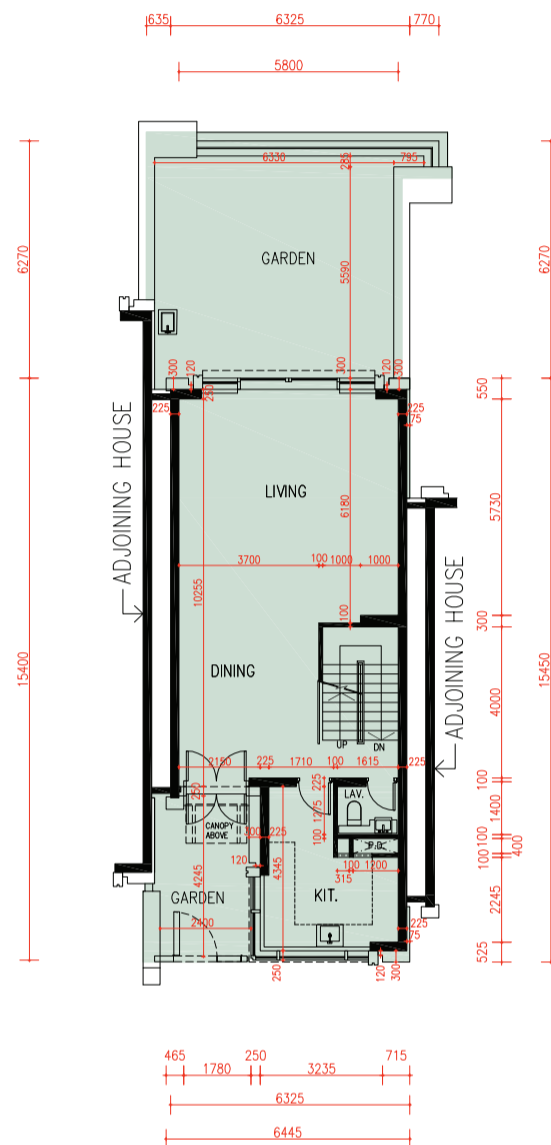

G/F Plan  
地下平面圖

scale 比例 0 5 10M (米)

Floor 樓層	The thickness of the floor slabs (excluding plaster) of each house (mm) 每座洋房的樓板(不包括灰泥)的厚度(毫米)	The floor-to-floor height of each house (mm) 每座洋房的層與層之間的高度(毫米)
LG/F 地下低層	200	6400
G/F 地下	175, 200, 250	4500
1/F 一樓	150, 175	4000
2/F 二樓	200, 225	4000
Roof 天台	150	2400

The internal areas of the houses on the upper floors will generally be slightly larger than those on the lower floors because of the reducing thickness of the structural walls on the upper floors. 因洋房的較高樓層的結構牆的厚度遞減，較高樓層的內部面積，一般比較低樓層的內部面積稍大。

Note:

- The dimensions of floor plans are all structural dimensions in millimeter.
- There may be architectural features and/or exposed pipes on external walls of some houses. For details, please refer to the latest approved building plans.
- Common pipes exposed and/or enclosed in cladding are located at/adjacent to flat roof and/or external wall of some houses. For details, please refer to the latest approved building plans and/or electrical and mechanical design drawings.
- There are ceiling bulkheads and/or sunken slab of the above houses at living/dining room, bedrooms, corridors and/or kitchen of the above houses for the air-conditioning system and/or M&E services.
- Please refer to page AL1 of this sales brochure for legend of the terms and abbreviations shown in the floor plan above.
- Floor-to-floor height refers to the height between the top surface of the structural slab of a floor and the top surface of the structural slab of its immediate upper floor.

備註:

- 平面圖所列之尺寸數字為以毫米標示之建築結構尺寸。
- 部份洋房外牆設有建築裝飾及/或外露喉管。詳細資料請參考最新批准之建築圖則。
- 部份洋房的平台及/或外牆設有外露及/或外牆裝飾板內藏之公用喉管。詳細資料請參考最新批准的建築圖則及/或機電設計圖。
- 部份洋房客/飯廳、睡房、走廊及/或廚房有假天花及/或有跌級樓板以內藏冷氣系統及/或機電設備。
- 以上平面圖中顯示之名詞及簡稱請參閱本售樓說明書第 AL1 頁。
- 層與層之間的高度指該樓層之石屎地台面與上一層石屎地台面之高度距離。

# FLOOR PLANS OF RESIDENTIAL PROPERTIES IN THE DEVELOPMENT

## 發展項目的住宅物業的樓面平面圖

17M Shouson Hill Road

壽山村道17M號

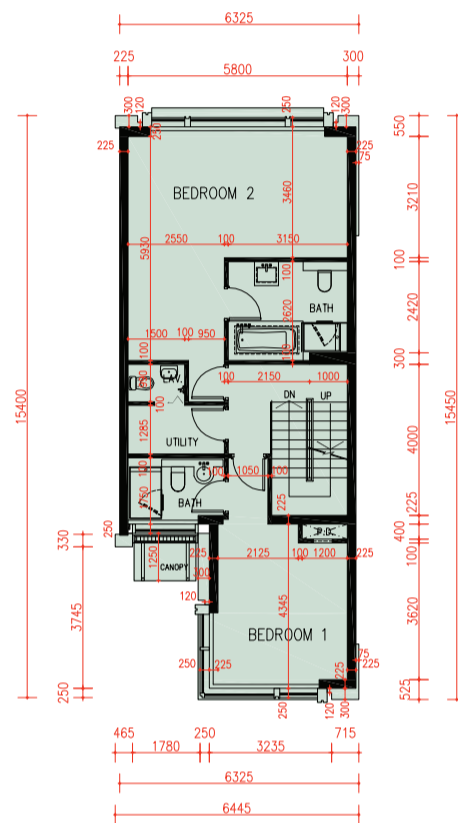

1/F Plan

一樓平面圖

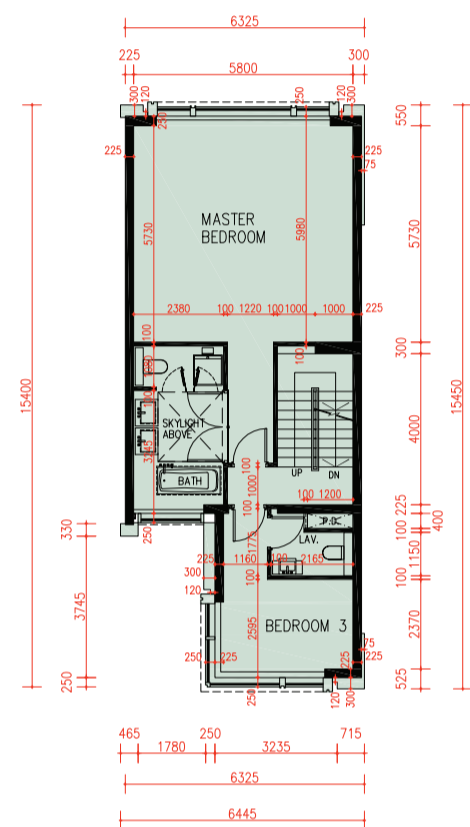

2/F Plan

二樓平面圖

scale 0 5 10M (米)  
比例

Floor 樓層	The thickness of the floor slabs (excluding plaster) of each house (mm) 每座洋房的樓板 (不包括灰泥) 的厚度 (毫米)	The floor-to-floor height of each house (mm) 每座洋房的層與層之間的高度 (毫米)
LG/F 地下低層	200	6400
G/F 地下	175, 200, 250	4500
1/F 一樓	150, 175	4000
2/F 二樓	200, 225	4000
Roof 天台	150	2400

The internal areas of the houses on the upper floors will generally be slightly larger than those on the lower floors because of the reducing thickness of the structural walls on the upper floors. 因洋房的較高樓層的結構牆的厚度遞減，較高樓層的內部面積，一般比較低樓層的內部面積稍大。

Note:

- The dimensions of floor plans are all structural dimensions in millimeter.
- There may be architectural features and/or exposed pipes on external walls of some houses. For details, please refer to the latest approved building plans.
- Common pipes exposed and/or enclosed in cladding are located at/adjacent to flat roof and/or external wall of some houses. For details, please refer to the latest approved building plans and/or electrical and mechanical design drawings.
- There are ceiling bulkheads and/or sunken slab of the above houses at living/dining room, bedrooms, corridors and/or kitchen of the above houses for the air-conditioning system and/or M&E services.
- Please refer to page AL1 of this sales brochure for legend of the terms and abbreviations shown in the floor plan above.
- Floor-to-floor height refers to the height between the top surface of the structural slab of a floor and the top surface of the structural slab of its immediate upper floor.

備註：

- 平面圖所列之尺寸數字為以毫米標示之建築結構尺寸。
- 部份洋房外牆設有建築裝飾及/或外露喉管。詳細資料請參考最新批准之建築圖則。
- 部份洋房的平台及/或外牆設有外露及/或外牆裝飾板內藏之公用喉管。詳細資料請參考最新批准的建築圖則及/或機電設計圖。
- 部份洋房客/飯廳、睡房、走廊及/或廚房有假天花及/或有跌級樓板以內藏冷氣系統及/或機電設備。
- 以上平面圖中顯示之名詞及簡稱請參閱本售樓說明書第 AL1 頁。
- 層與層之間的高度指該樓層之石屎地台面與上一層石屎地台面之高度距離。

# FLOOR PLANS OF RESIDENTIAL PROPERTIES IN THE DEVELOPMENT

## 發展項目的住宅物業的樓面平面圖

17M Shouson Hill Road

壽山村道17M號

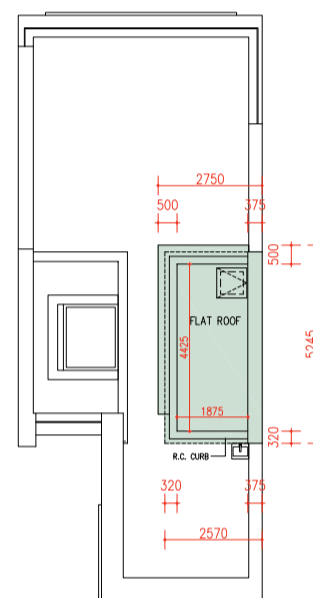
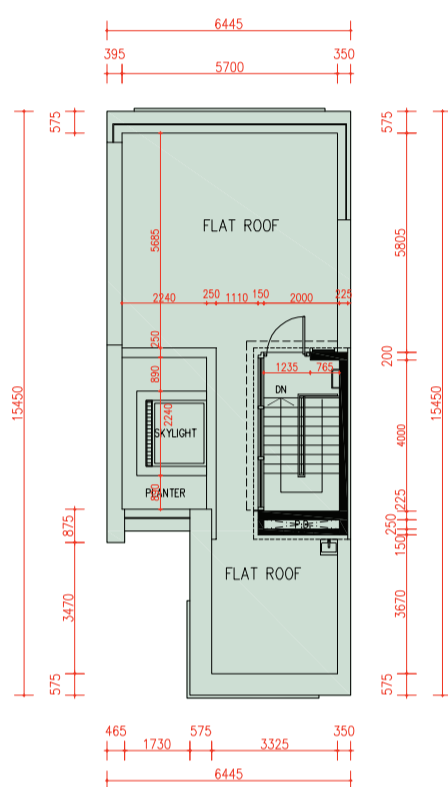
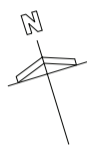

### Roof Plan

天台平面圖

### Upper Roof Plan

上層天台平面圖

scale 比例 0 5 10M (米)

Floor 樓層	The thickness of the floor slabs (excluding plaster) of each house (mm) 每座洋房的樓板(不包括灰泥)的厚度(毫米)	The floor-to-floor height of each house (mm) 每座洋房的層與層之間的高度(毫米)
LG/F 地下低層	200	6400
G/F 地下	175, 200, 250	4500
1/F 一樓	150, 175	4000
2/F 二樓	200, 225	4000
Roof 天台	150	2400

The internal areas of the houses on the upper floors will generally be slightly larger than those on the lower floors because of the reducing thickness of the structural walls on the upper floors. 因洋房的較高樓層的結構牆的厚度遞減，較高樓層的內部面積，一般比較低樓層的內部面積稍大。

Note:

- The dimensions of floor plans are all structural dimensions in millimeter.
- There may be architectural features and/or exposed pipes on external walls of some houses. For details, please refer to the latest approved building plans.
- Common pipes exposed and/or enclosed in cladding are located at/adjacent to flat roof and/or external wall of some houses. For details, please refer to the latest approved building plans and/or electrical and mechanical design drawings.
- There are ceiling bulkheads and/or sunken slab of the above houses at living/dining room, bedrooms, corridors and/or kitchen of the above houses for the air-conditioning system and/or M&E services.
- Please refer to page AL1 of this sales brochure for legend of the terms and abbreviations shown in the floor plan above.
- Floor-to-floor height refers to the height between the top surface of the structural slab of a floor and the top surface of the structural slab of its immediate upper floor.

備註:

- 平面圖所列之尺寸數字為以毫米標示之建築結構尺寸。
- 部份洋房外牆設有建築裝飾及/或外露喉管。詳細資料請參考最新批准之建築圖則。
- 部份洋房的平台及/或外牆設有外露及/或外牆裝飾板內藏之公用喉管。詳細資料請參考最新批准之建築圖則及/或機電設計圖。
- 部份洋房客/飯廳、睡房、走廊及/或廚房有假天花及/或有跌級樓板以內藏冷氣系統及/或機電設備。
- 以上平面圖中顯示之名詞及簡稱請參閱本售樓說明書第 AL1 頁。
- 層與層之間的高度指該樓層之石屎地台面與上一層石屎地台面之高度距離。



# FLOOR PLANS OF RESIDENTIAL PROPERTIES IN THE DEVELOPMENT

## 發展項目的住宅物業的樓面平面圖

17N Shouson Hill Road

壽山村道17N號

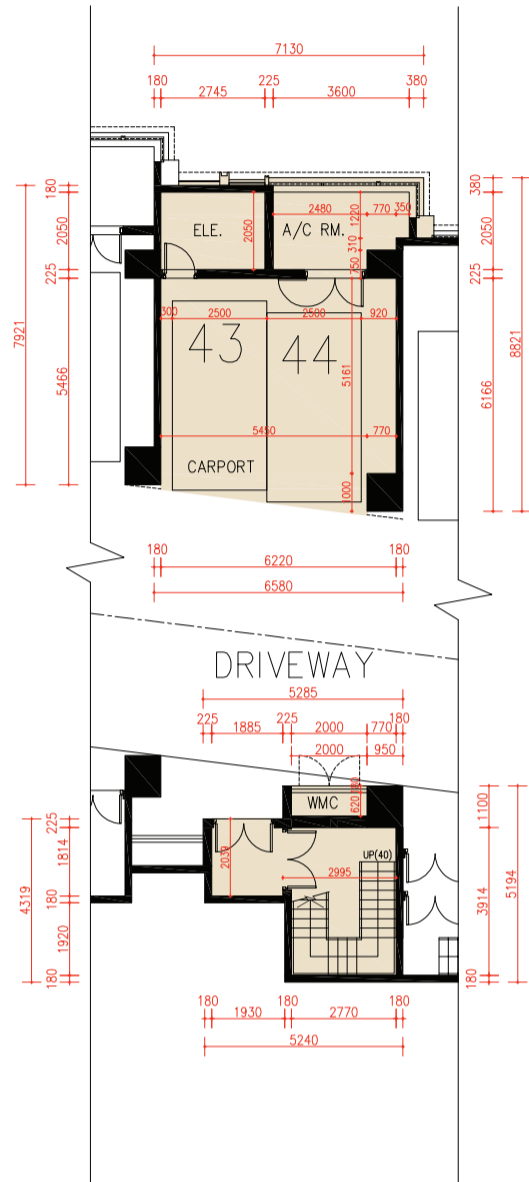

LG/F Plan  
地下低層平面圖

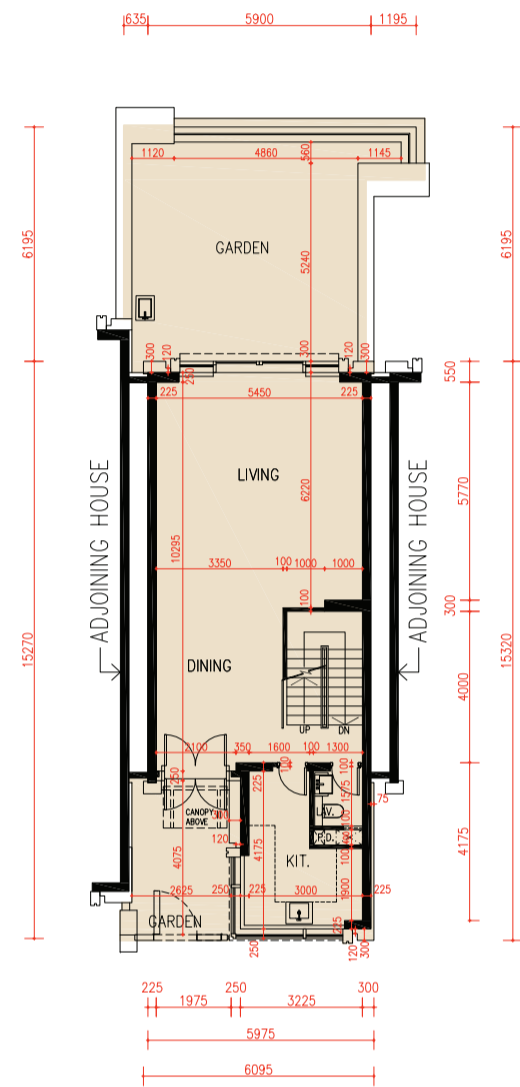

G/F Plan  
地下平面圖

scale 比例 0 5 10M (米)

Floor 樓層	The thickness of the floor slabs (excluding plaster) of each house (mm) 每座洋房的樓板(不包括灰泥)的厚度(毫米)	The floor-to-floor height of each house (mm) 每座洋房的層與層之間的高度(毫米)
LG/F 地下低層	200	6750
G/F 地下	175, 200, 250	4500
1/F 一樓	150, 175	4000
2/F 二樓	200, 225	4000
Roof 天台	150	2400

The internal areas of the houses on the upper floors will generally be slightly larger than those on the lower floors because of the reducing thickness of the structural walls on the upper floors. 因洋房的較高樓層的結構牆的厚度遞減，較高樓層的內部面積，一般比較低樓層的內部面積稍大。

Note:

- The dimensions of floor plans are all structural dimensions in millimeter.
- There may be architectural features and/or exposed pipes on external walls of some houses. For details, please refer to the latest approved building plans.
- Common pipes exposed and/or enclosed in cladding are located at/adjacent to flat roof and/or external wall of some houses. For details, please refer to the latest approved building plans and/or electrical and mechanical design drawings.
- There are ceiling bulkheads and/or sunken slab of the above houses at living/dining room, bedrooms, corridors and/or kitchen of the above houses for the air-conditioning system and/or M&E services.
- Please refer to page AL1 of this sales brochure for legend of the terms and abbreviations shown in the floor plan above.
- Floor-to-floor height refers to the height between the top surface of the structural slab of a floor and the top surface of the structural slab of its immediate upper floor.

備註：

- 平面圖所列之尺寸數字為以毫米標示之建築結構尺寸。
- 部份洋房外牆設有建築裝飾及/或外露喉管。詳細資料請參考最新批准之建築圖則。
- 部份洋房的平台及/或外牆設有外露及/或外牆裝飾板內藏之公用喉管。詳細資料請參考最新批准的建築圖則及/或機電設計圖。
- 部份洋房客/飯廳、睡房、走廊及/或廚房有假天花及/或有跌級樓板以內藏冷氣系統及/或機電設備。
- 以上平面圖中顯示之名詞及簡稱請參閱本售樓說明書第AL1頁。
- 層與層之間的高度指該樓層之石屎地台面與上一層石屎地台面之高度距離。

# FLOOR PLANS OF RESIDENTIAL PROPERTIES IN THE DEVELOPMENT

## 發展項目的住宅物業的樓面平面圖

17N Shouson Hill Road

壽山村道17N號

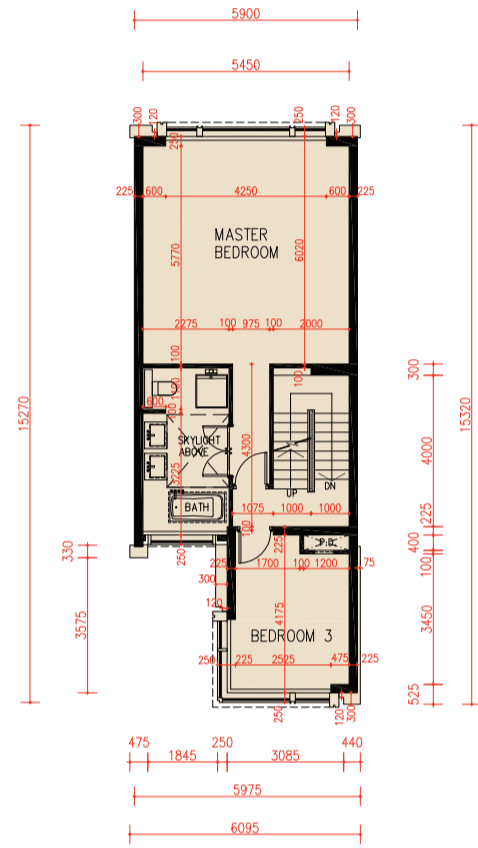
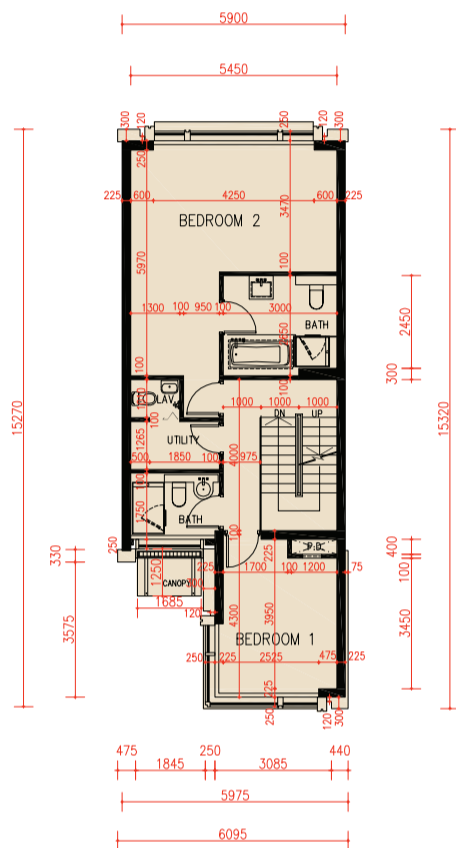

### 1/F Plan

一樓平面圖

### 2/F Plan

二樓平面圖

scale 比例 0 5 10M (米)

Floor 樓層	The thickness of the floor slabs (excluding plaster) of each house (mm) 每座洋房的樓板(不包括灰泥)的厚度(毫米)	The floor-to-floor height of each house (mm) 每座洋房的層與層之間的高度(毫米)
LG/F 地下低層	200	6750
G/F 地下	175, 200, 250	4500
1/F 一樓	150, 175	4000
2/F 二樓	200, 225	4000
Roof 天台	150	2400

The internal areas of the houses on the upper floors will generally be slightly larger than those on the lower floors because of the reducing thickness of the structural walls on the upper floors. 因洋房的較高樓層的結構牆的厚度遞減，較高樓層的內部面積，一般比較低樓層的內部面積稍大。

Note:

- The dimensions of floor plans are all structural dimensions in millimeter.
- There may be architectural features and/or exposed pipes on external walls of some houses. For details, please refer to the latest approved building plans.
- Common pipes exposed and/or enclosed in cladding are located at/adjacent to flat roof and/or external wall of some houses. For details, please refer to the latest approved building plans and/or electrical and mechanical design drawings.
- There are ceiling bulkheads and/or sunken slab of the above houses at living/dining room, bedrooms, corridors and/or kitchen of the above houses for the air-conditioning system and/or M&E services.
- Please refer to page AL1 of this sales brochure for legend of the terms and abbreviations shown in the floor plan above.
- Floor-to-floor height refers to the height between the top surface of the structural slab of a floor and the top surface of the structural slab of its immediate upper floor.

備註:

- 平面圖所列之尺寸數字為以毫米標示之建築結構尺寸。
- 部份洋房外牆設有建築裝飾及/或外露喉管。詳細資料請參考最新批准之建築圖則。
- 部份洋房的平台及/或外牆設有外露及/或外牆裝飾板內藏之公用喉管。詳細資料請參考最新批准的建築圖則及/或機電設計圖。
- 部份洋房客/飯廳、睡房、走廊及/或廚房有假天花及/或有跌級樓板以內藏冷氣系統及/或機電設備。
- 以上平面圖中顯示之名詞及簡稱請參閱本售樓說明書第 AL1 頁。
- 層與層之間的高度指該樓層之石屎地台面與上一層石屎地台面之高度距離。

# FLOOR PLANS OF RESIDENTIAL PROPERTIES IN THE DEVELOPMENT

## 發展項目的住宅物業的樓面平面圖

17N Shouson Hill Road

壽山村道17N號

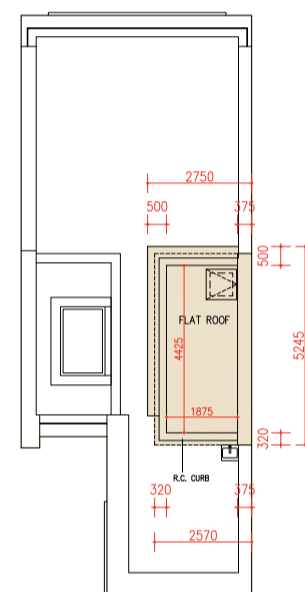
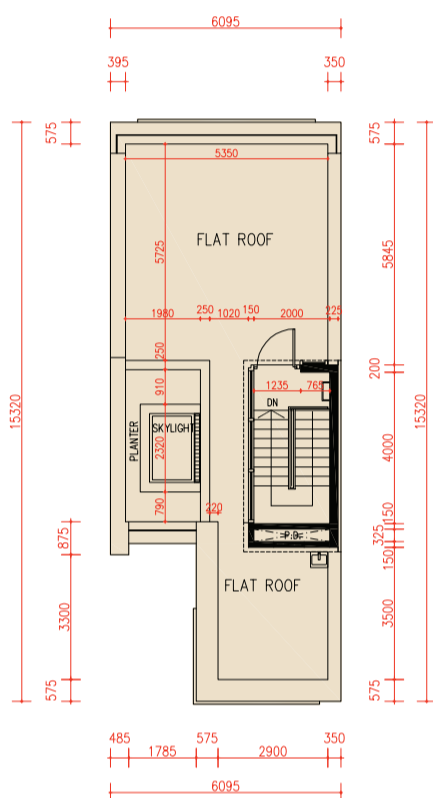

### Roof Plan

#### 天台平面圖

### Upper Roof Plan

#### 上層天台平面圖

scale 0 5 10M (米)  
比例

Floor 樓層	The thickness of the floor slabs (excluding plaster) of each house (mm) 每座洋房的樓板(不包括灰泥)的厚度(毫米)	The floor-to-floor height of each house (mm) 每座洋房的層與層之間的高度(毫米)
LG/F 地下低層	200	6750
G/F 地下	175, 200, 250	4500
1/F 一樓	150, 175	4000
2/F 二樓	200, 225	4000
Roof 天台	150	2400

The internal areas of the houses on the upper floors will generally be slightly larger than those on the lower floors because of the reducing thickness of the structural walls on the upper floors. 因洋房的較高樓層的結構牆的厚度遞減，較高樓層的內部面積，一般比較低樓層的內部面積稍大。

Note:

- The dimensions of floor plans are all structural dimensions in millimeter.
- There may be architectural features and/or exposed pipes on external walls of some houses. For details, please refer to the latest approved building plans.
- Common pipes exposed and/or enclosed in cladding are located at/adjacent to flat roof and/or external wall of some houses. For details, please refer to the latest approved building plans and/or electrical and mechanical design drawings.
- There are ceiling bulkheads and/or sunken slab of the above houses at living/dining room, bedrooms, corridors and/or kitchen of the above houses for the air-conditioning system and/or M&E services.
- Please refer to page AL1 of this sales brochure for legend of the terms and abbreviations shown in the floor plan above.
- Floor-to-floor height refers to the height between the top surface of the structural slab of a floor and the top surface of the structural slab of its immediate upper floor.

備註：

- 平面圖所列之尺寸數字為以毫米標示之建築結構尺寸。
- 部份洋房外牆設有建築裝飾及/或外露喉管。詳細資料請參考最新批准之建築圖則。
- 部份洋房的平台及/或外牆設有外露及/或外牆裝飾板內藏之公用喉管。詳細資料請參考最新批准的建築圖則及/或機電設計圖。
- 部份洋房客/飯廳、睡房、走廊及/或廚房有假天花及/或有跌級樓板以內藏冷氣系統及/或機電設備。
- 以上平面圖中顯示之名詞及簡稱請參閱本售樓說明書第 AL1 頁。
- 層與層之間的高度指該樓層之石屎地台面與上一層石屎地台面之高度距離。

# FLOOR PLANS OF RESIDENTIAL PROPERTIES IN THE DEVELOPMENT

## 發展項目的住宅物業的樓面平面圖

17P Shouson Hill Road

壽山村道17P號

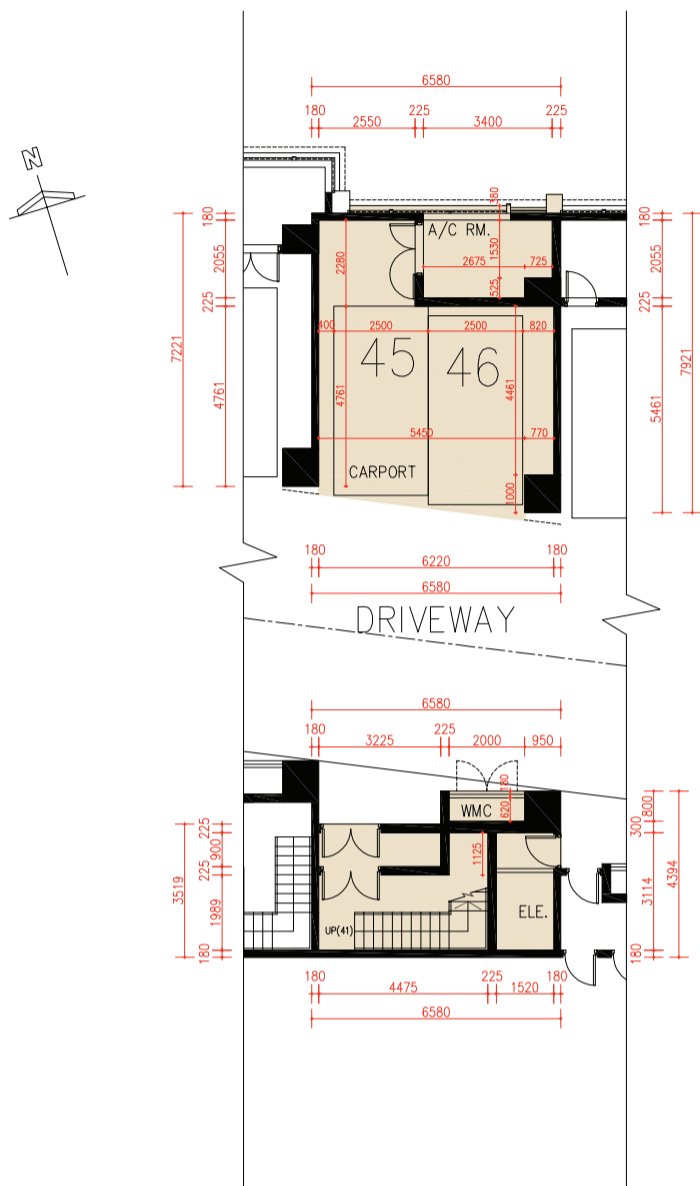

LG/F Plan  
地下低層平面圖

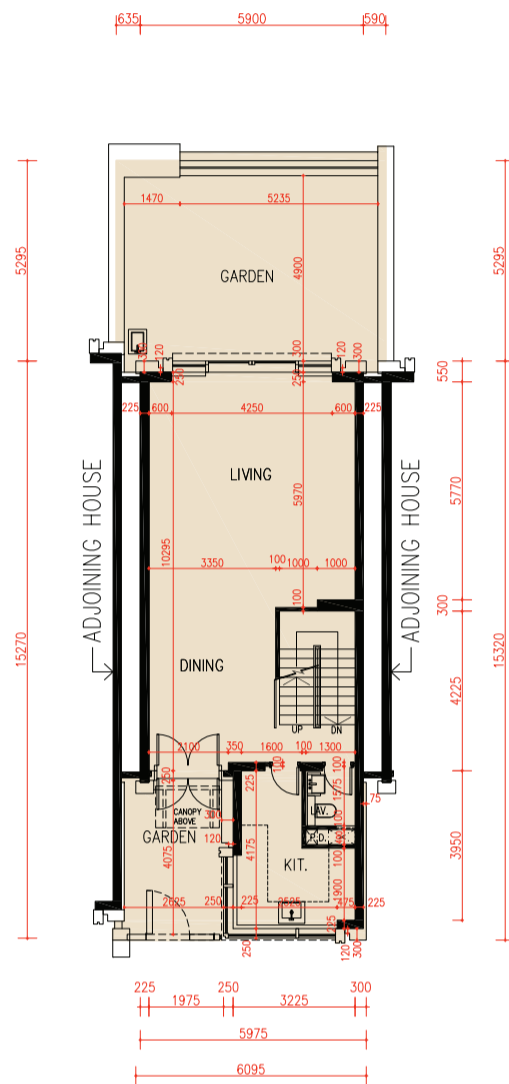

G/F Plan  
地下平面圖

scale 比例 0 5 10M (米)

Floor 樓層	The thickness of the floor slabs (excluding plaster) of each house (mm) 每座洋房的樓板(不包括灰泥)的厚度(毫米)	The floor-to-floor height of each house (mm) 每座洋房的層與層之間的高度(毫米)
LG/F 地下低層	200	6900
G/F 地下	175, 200, 250	4500
1/F 一樓	150, 175	4000
2/F 二樓	200, 225	4000
Roof 天台	150	2400

The internal areas of the houses on the upper floors will generally be slightly larger than those on the lower floors because of the reducing thickness of the structural walls on the upper floors. 因洋房的較高樓層的結構牆的厚度遞減，較高樓層的內部面積，一般比較低樓層的內部面積稍大。

Note:

- The dimensions of floor plans are all structural dimensions in millimeter.
- There may be architectural features and/or exposed pipes on external walls of some houses. For details, please refer to the latest approved building plans.
- Common pipes exposed and/or enclosed in cladding are located at/adjacent to flat roof and/or external wall of some houses. For details, please refer to the latest approved building plans and/or electrical and mechanical design drawings.
- There are ceiling bulkheads and/or sunken slab of the above houses at living/dining room, bedrooms, corridors and/or kitchen of the above houses for the air-conditioning system and/or M&E services.
- Please refer to page AL1 of this sales brochure for legend of the terms and abbreviations shown in the floor plan above.
- Floor-to-floor height refers to the height between the top surface of the structural slab of a floor and the top surface of the structural slab of its immediate upper floor.

備註:

- 平面圖所列之尺寸數字為以毫米標示之建築結構尺寸。
- 部份洋房外牆設有建築裝飾及/或外露喉管。詳細資料請參考最新批准之建築圖則。
- 部份洋房的平台及/或外牆設有外露及/或外牆裝飾板內藏之公用喉管。詳細資料請參考最新批准的建築圖則及/或機電設計圖。
- 部份洋房客/飯廳、睡房、走廊及/或廚房有假天花及/或有跌級樓板以內藏冷氣系統及/或機電設備。
- 以上平面圖中顯示之名詞及簡稱請參閱本售樓說明書第 AL1 頁。
- 層與層之間的高度指該樓層之石屎地台面與上一層石屎地台面之高度距離。

# FLOOR PLANS OF RESIDENTIAL PROPERTIES IN THE DEVELOPMENT

## 發展項目的住宅物業的樓面平面圖

17P Shouson Hill Road

壽山村道17P號

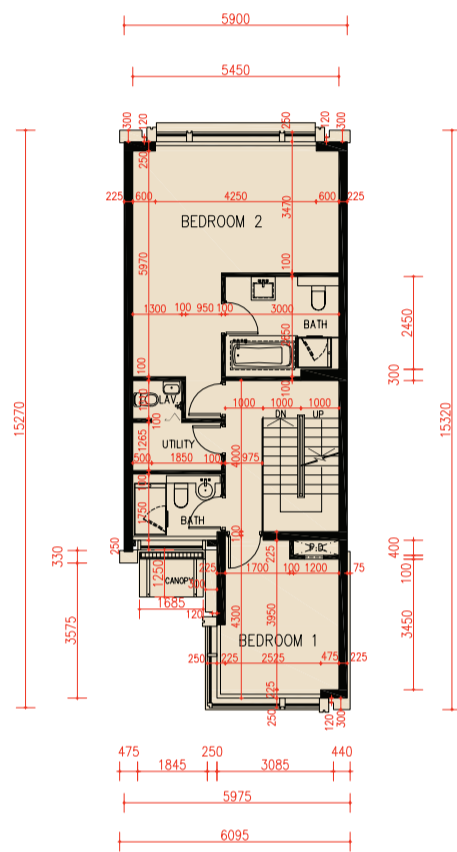

1/F Plan

一樓平面圖

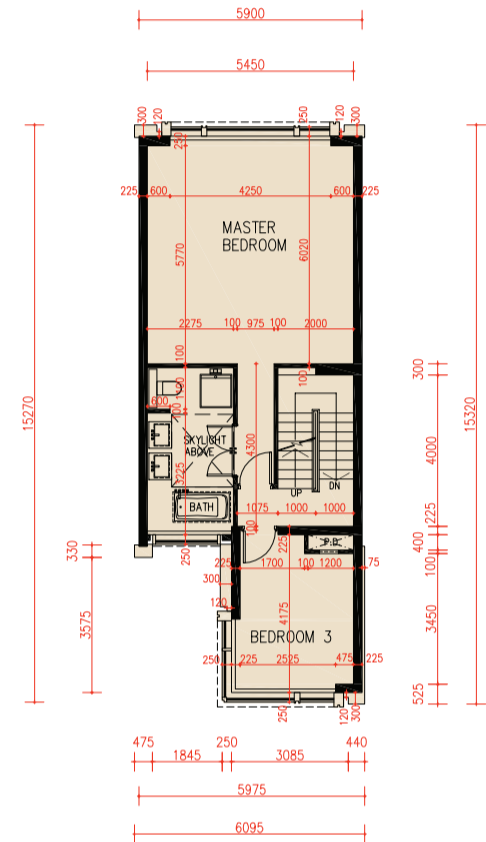

2/F Plan

二樓平面圖

scale 比例 0 5 10M (米)

Floor 樓層	The thickness of the floor slabs (excluding plaster) of each house (mm) 每座洋房的樓板(不包括灰泥)的厚度(毫米)	The floor-to-floor height of each house (mm) 每座洋房的層與層之間的高度(毫米)
LG/F 地下低層	200	6900
G/F 地下	175, 200, 250	4500
1/F 一樓	150, 175	4000
2/F 二樓	200, 225	4000
Roof 天台	150	2400

The internal areas of the houses on the upper floors will generally be slightly larger than those on the lower floors because of the reducing thickness of the structural walls on the upper floors. 因洋房的較高樓層的結構牆的厚度遞減，較高樓層的內部面積，一般比較低樓層的內部面積稍大。

Note:

- The dimensions of floor plans are all structural dimensions in millimeter.
- There may be architectural features and/or exposed pipes on external walls of some houses. For details, please refer to the latest approved building plans.
- Common pipes exposed and/or enclosed in cladding are located at/adjacent to flat roof and/or external wall of some houses. For details, please refer to the latest approved building plans and/or electrical and mechanical design drawings.
- There are ceiling bulkheads and/or sunken slab of the above houses at living/dining room, bedrooms, corridors and/or kitchen of the above houses for the air-conditioning system and/or M&E services.
- Please refer to page AL1 of this sales brochure for legend of the terms and abbreviations shown in the floor plan above.
- Floor-to-floor height refers to the height between the top surface of the structural slab of a floor and the top surface of the structural slab of its immediate upper floor.

備註：

- 平面圖所列之尺寸數字為以毫米標示之建築結構尺寸。
- 部份洋房外牆設有建築裝飾及/或外露喉管。詳細資料請參考最新批准之建築圖則。
- 部份洋房的平台及/或外牆設有外露及/或外牆裝飾板內藏之公用喉管。詳細資料請參考最新批准的建築圖則及/或機電設計圖。
- 部份洋房客/飯廳、睡房、走廊及/或廚房有假天花及/或有跌級樓板以內藏冷氣系統及/或機電設備。
- 以上平面圖中顯示之名詞及簡稱請參閱本售樓說明書第 AL1 頁。
- 層與層之間的高度指該樓層之石屎地台面與上一層石屎地台面之高度距離。



# FLOOR PLANS OF RESIDENTIAL PROPERTIES IN THE DEVELOPMENT

## 發展項目的住宅物業的樓面平面圖

17P Shouson Hill Road

壽山村道17P號

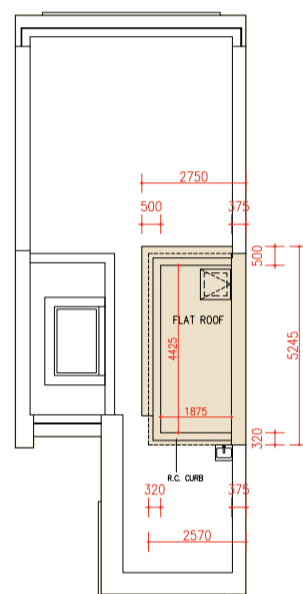
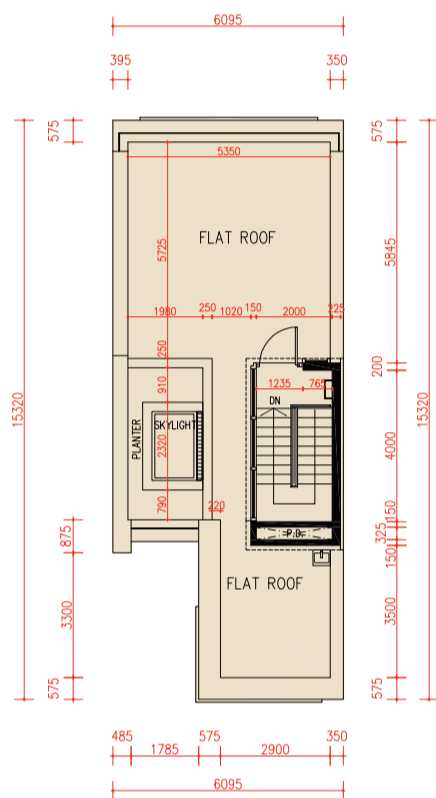

### Roof Plan

天台平面圖

### Upper Roof Plan

上層天台平面圖

scale 比例 0 5 10M (米)

Floor 樓層	The thickness of the floor slabs (excluding plaster) of each house (mm) 每座洋房的樓板(不包括灰泥)的厚度(毫米)	The floor-to-floor height of each house (mm) 每座洋房的層與層之間的高度(毫米)
LG/F 地下低層	200	6900
G/F 地下	175, 200, 250	4500
1/F 一樓	150, 175	4000
2/F 二樓	200, 225	4000
Roof 天台	150	2400

The internal areas of the houses on the upper floors will generally be slightly larger than those on the lower floors because of the reducing thickness of the structural walls on the upper floors. 因洋房的較高樓層的結構牆的厚度遞減，較高樓層的內部面積，一般比較低樓層的內部面積稍大。

Note:

- The dimensions of floor plans are all structural dimensions in millimeter.
- There may be architectural features and/or exposed pipes on external walls of some houses. For details, please refer to the latest approved building plans.
- Common pipes exposed and/or enclosed in cladding are located at/adjacent to flat roof and/or external wall of some houses. For details, please refer to the latest approved building plans and/or electrical and mechanical design drawings.
- There are ceiling bulkheads and/or sunken slab of the above houses at living/dining room, bedrooms, corridors and/or kitchen of the above houses for the air-conditioning system and/or M&E services.
- Please refer to page AL1 of this sales brochure for legend of the terms and abbreviations shown in the floor plan above.
- Floor-to-floor height refers to the height between the top surface of the structural slab of a floor and the top surface of the structural slab of its immediate upper floor.

備註：

- 平面圖所列之尺寸數字為以毫米標示之建築結構尺寸。
- 部份洋房外牆設有建築裝飾及/或外露喉管。詳細資料請參考最新批准之建築圖則。
- 部份洋房的平台及/或外牆設有外露及/或外牆裝飾板內藏之公用喉管。詳細資料請參考最新批准之建築圖則及/或機電設計圖。
- 部份洋房客/飯廳、睡房、走廊及/或廚房有假天花及/或有跌級樓板以內藏冷氣系統及/或機電設備。
- 以上平面圖中顯示之名詞及簡稱請參閱本售樓說明書第 AL1 頁。
- 層與層之間的高度指該樓層之石屎地台面與上一層石屎地台面之高度距離。

# FLOOR PLANS OF RESIDENTIAL PROPERTIES IN THE DEVELOPMENT

## 發展項目的住宅物業的樓面平面圖

17Q Shouson Hill Road

壽山村道17Q號

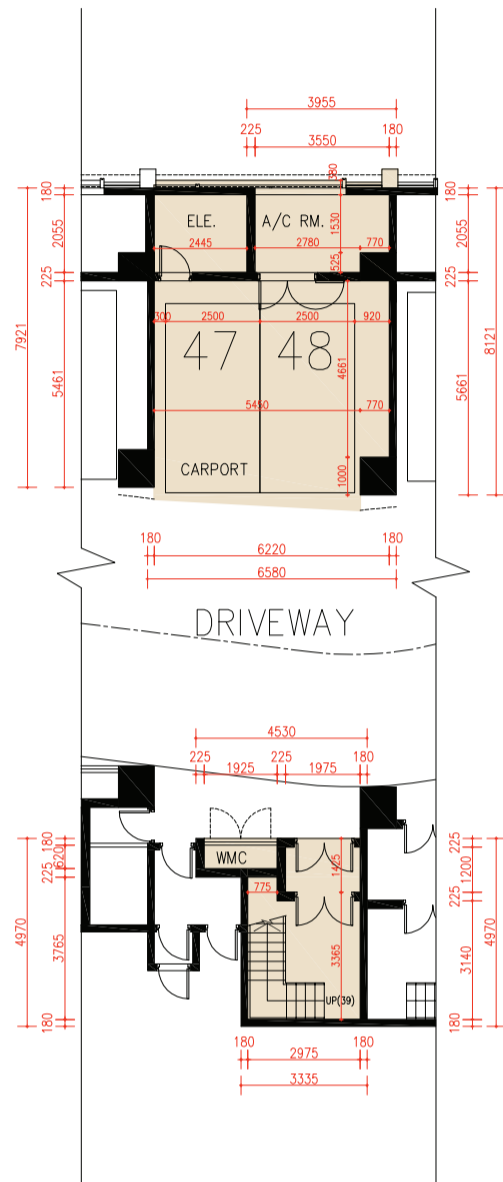

LG/F Plan

地下低層平面圖

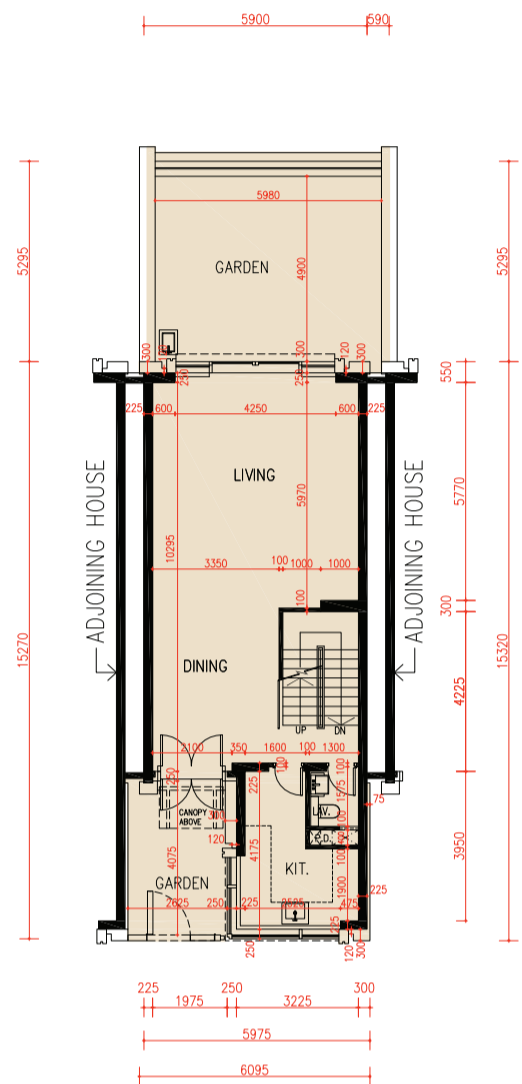

G/F Plan

地下平面圖

scale 0 5 10M (米)  
比例

Floor 樓層	The thickness of the floor slabs (excluding plaster) of each house (mm) 每座洋房的樓板(不包括灰泥)的厚度(毫米)	The floor-to-floor height of each house (mm) 每座洋房的層與層之間的高度(毫米)
LG/F 地下低層	200	6600
G/F 地下	175, 200, 250	4500
1/F 一樓	150, 175	4000
2/F 二樓	200, 225	4000
Roof 天台	150	2400

The internal areas of the houses on the upper floors will generally be slightly larger than those on the lower floors because of the reducing thickness of the structural walls on the upper floors. 因洋房的較高樓層的結構牆的厚度遞減，較高樓層的內部面積，一般比較低樓層的內部面積稍大。

Note:

- The dimensions of floor plans are all structural dimensions in millimeter.
- There may be architectural features and/or exposed pipes on external walls of some houses. For details, please refer to the latest approved building plans.
- Common pipes exposed and/or enclosed in cladding are located at/adjacent to flat roof and/or external wall of some houses. For details, please refer to the latest approved building plans and/or electrical and mechanical design drawings.
- There are ceiling bulkheads and/or sunken slab of the above houses at living/dining room, bedrooms, corridors and/or kitchen of the above houses for the air-conditioning system and/or M&E services.
- Please refer to page AL1 of this sales brochure for legend of the terms and abbreviations shown in the floor plan above.
- Floor-to-floor height refers to the height between the top surface of the structural slab of a floor and the top surface of the structural slab of its immediate upper floor.

備註:

- 平面圖所列之尺寸數字為以毫米標示之建築結構尺寸。
- 部份洋房外牆設有建築裝飾及/或外露喉管。詳細資料請參考最新批准之建築圖則。
- 部份洋房的平台及/或外牆設有外露及/或外牆裝飾板內藏之公用喉管。詳細資料請參考最新批准的建築圖則及/或機電設計圖。
- 部份洋房客/飯廳、睡房、走廊及/或廚房有假天花及/或有跌級樓板以內藏冷氣系統及/或機電設備。
- 以上平面圖中顯示之名詞及簡稱請參閱本售樓說明書第AL1頁。
- 層與層之間的高度指該樓層之石屎地台面與上一層石屎地台面之高度距離。

# FLOOR PLANS OF RESIDENTIAL PROPERTIES IN THE DEVELOPMENT

## 發展項目的住宅物業的樓面平面圖

17Q Shouson Hill Road

壽山村道17Q號

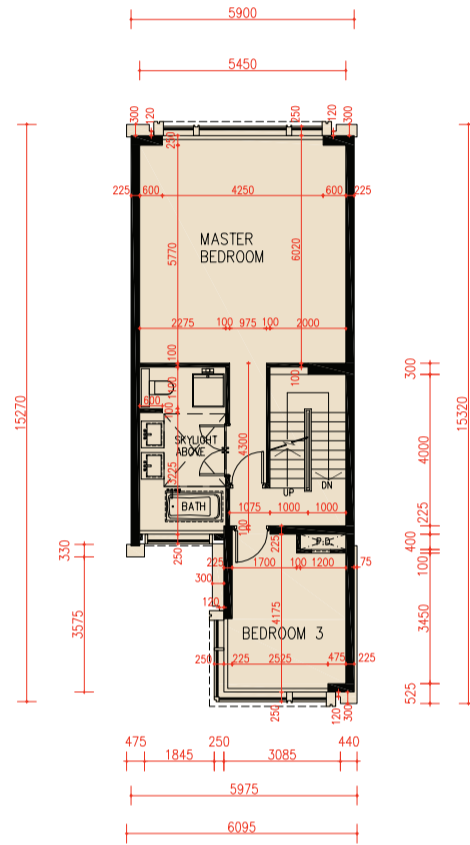
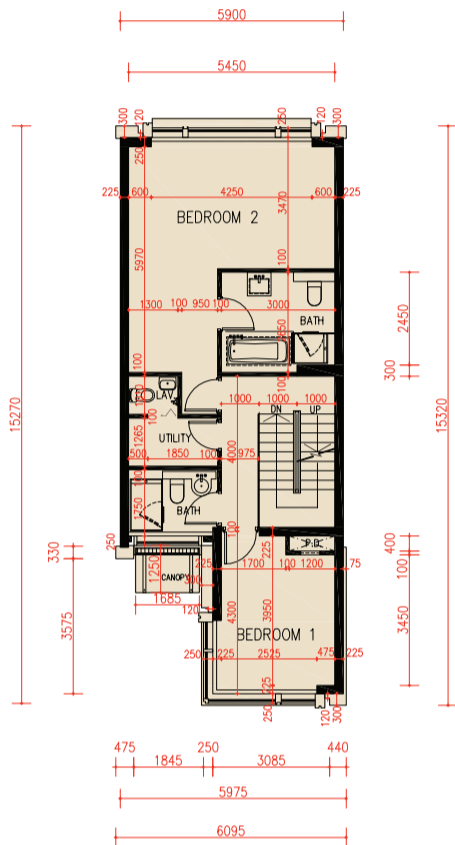

### 1/F Plan

一樓平面圖

### 2/F Plan

二樓平面圖

scale 比例 0 5 10M (米)

Floor 樓層	The thickness of the floor slabs (excluding plaster) of each house (mm) 每座洋房的樓板(不包括灰泥)的厚度(毫米)	The floor-to-floor height of each house (mm) 每座洋房的層與層之間的高度(毫米)
LG/F 地下低層	200	6600
G/F 地下	175, 200, 250	4500
1/F 一樓	150, 175	4000
2/F 二樓	200, 225	4000
Roof 天台	150	2400

The internal areas of the houses on the upper floors will generally be slightly larger than those on the lower floors because of the reducing thickness of the structural walls on the upper floors. 因洋房的較高樓層的結構牆的厚度遞減，較高樓層的內部面積，一般比較低樓層的內部面積稍大。

Note:

- The dimensions of floor plans are all structural dimensions in millimeter.
- There may be architectural features and/or exposed pipes on external walls of some houses. For details, please refer to the latest approved building plans.
- Common pipes exposed and/or enclosed in cladding are located at/adjacent to flat roof and/or external wall of some houses. For details, please refer to the latest approved building plans and/or electrical and mechanical design drawings.
- There are ceiling bulkheads and/or sunken slab of the above houses at living/dining room, bedrooms, corridors and/or kitchen of the above houses for the air-conditioning system and/or M&E services.
- Please refer to page AL1 of this sales brochure for legend of the terms and abbreviations shown in the floor plan above.
- Floor-to-floor height refers to the height between the top surface of the structural slab of a floor and the top surface of the structural slab of its immediate upper floor.

備註:

- 平面圖所列之尺寸數字為以毫米標示之建築結構尺寸。
- 部份洋房外牆設有建築裝飾及/或外露喉管。詳細資料請參考最新批准之建築圖則。
- 部份洋房的平台及/或外牆設有外露及/或外牆裝飾板內藏之公用喉管。詳細資料請參考最新批准的建築圖則及/或機電設計圖。
- 部份洋房客/飯廳、睡房、走廊及/或廚房有假天花及/或有跌級樓板以內藏冷氣系統及/或機電設備。
- 以上平面圖中顯示之名詞及簡稱請參閱本售樓說明書第 AL1 頁。
- 層與層之間的高度指該樓層之石屎地台面與上一層石屎地台面之高度距離。

# FLOOR PLANS OF RESIDENTIAL PROPERTIES IN THE DEVELOPMENT

## 發展項目的住宅物業的樓面平面圖

17Q Shouson Hill Road

壽山村道17Q號

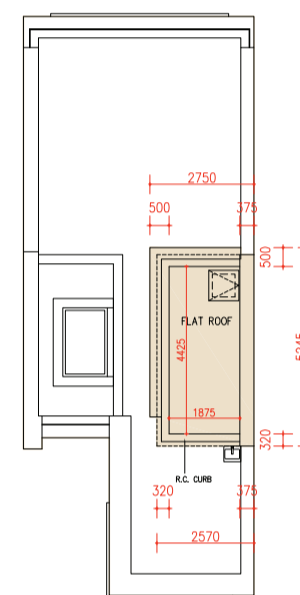
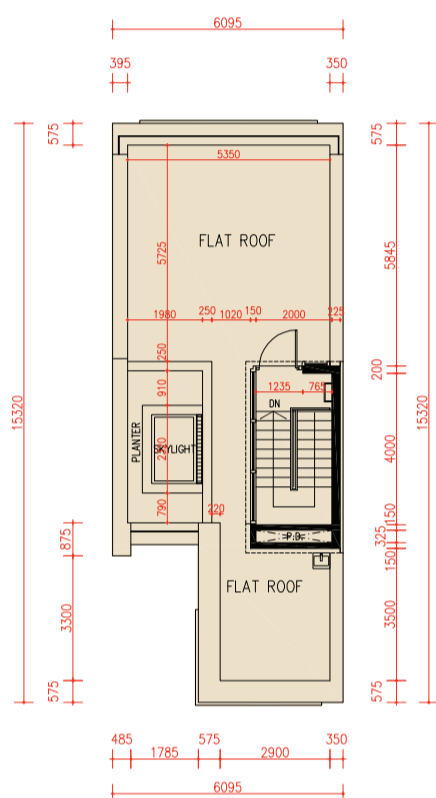

Roof Plan  
天台平面圖

Upper Roof Plan  
上層天台平面圖

scale 比例 0 5 10M (米)

Floor 樓層	The thickness of the floor slabs (excluding plaster) of each house (mm) 每座洋房的樓板(不包括灰泥)的厚度(毫米)	The floor-to-floor height of each house (mm) 每座洋房的層與層之間的高度(毫米)
LG/F 地下低層	200	6600
G/F 地下	175, 200, 250	4500
1/F 一樓	150, 175	4000
2/F 二樓	200, 225	4000
Roof 天台	150	2400

The internal areas of the houses on the upper floors will generally be slightly larger than those on the lower floors because of the reducing thickness of the structural walls on the upper floors. 因洋房的較高樓層的結構牆的厚度遞減，較高樓層的內部面積，一般比較低樓層的內部面積稍大。

Note:

- The dimensions of floor plans are all structural dimensions in millimeter.
- There may be architectural features and/or exposed pipes on external walls of some houses. For details, please refer to the latest approved building plans.
- Common pipes exposed and/or enclosed in cladding are located at/adjacent to flat roof and/or external wall of some houses. For details, please refer to the latest approved building plans and/or electrical and mechanical design drawings.
- There are ceiling bulkheads and/or sunken slab of the above houses at living/dining room, bedrooms, corridors and/or kitchen of the above houses for the air-conditioning system and/or M&E services.
- Please refer to page AL1 of this sales brochure for legend of the terms and abbreviations shown in the floor plan above.
- Floor-to-floor height refers to the height between the top surface of the structural slab of a floor and the top surface of the structural slab of its immediate upper floor.

備註：

- 平面圖所列之尺寸數字為以毫米標示之建築結構尺寸。
- 部份洋房外牆設有建築裝飾及/或外露喉管。詳細資料請參考最新批准之建築圖則。
- 部份洋房的平台及/或外牆設有外露及/或外牆裝飾板內藏之公用喉管。詳細資料請參考最新批准的建築圖則及/或機電設計圖。
- 部份洋房客/飯廳、睡房、走廊及/或廚房有假天花及/或有跌級樓板以內藏冷氣系統及/或機電設備。
- 以上平面圖中顯示之名詞及簡稱請參閱本售樓說明書第 AL1 頁。
- 層與層之間的高度指該樓層之石屎地台面與上一層石屎地台面之高度距離。

# FLOOR PLANS OF RESIDENTIAL PROPERTIES IN THE DEVELOPMENT

## 發展項目的住宅物業的樓面平面圖

17R Shouson Hill Road

壽山村道17R號

Remark:

Alterations have been made to 17R Shouson Hill Road, please refer to the "as-is" layout plans on pages AL94 to AL96 for such alterations.

備註:

壽山村道17R號經過改動,有關改動請參閱第AL94至AL96頁之現狀平面圖。

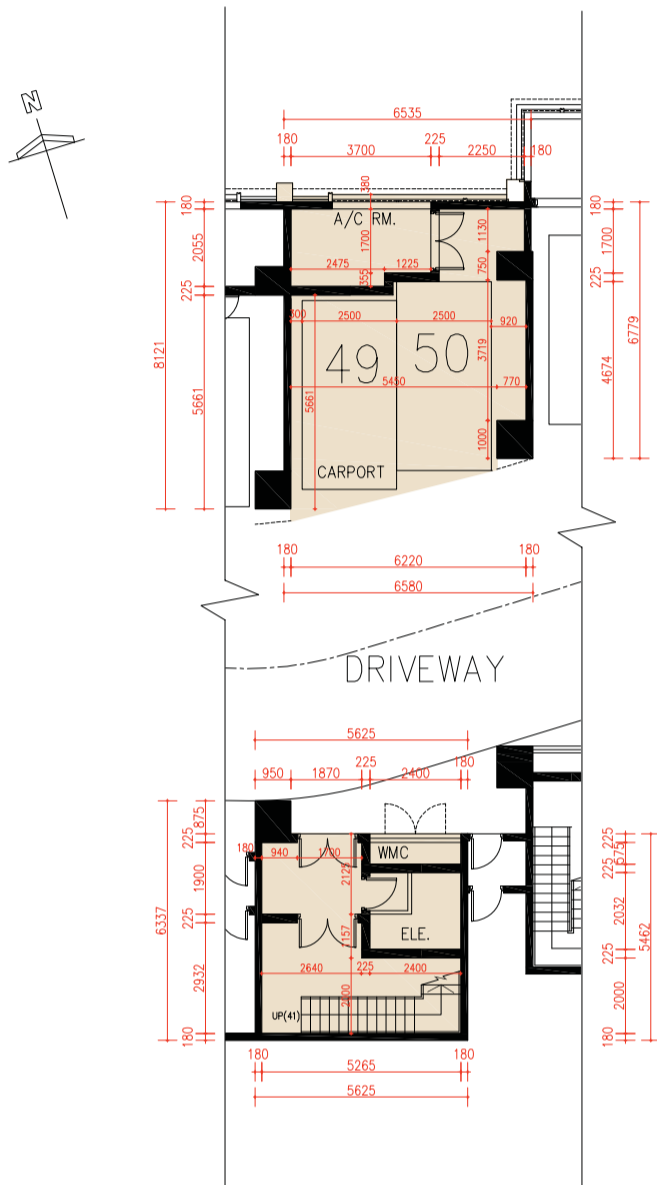

LG/F Plan

地下低層平面圖

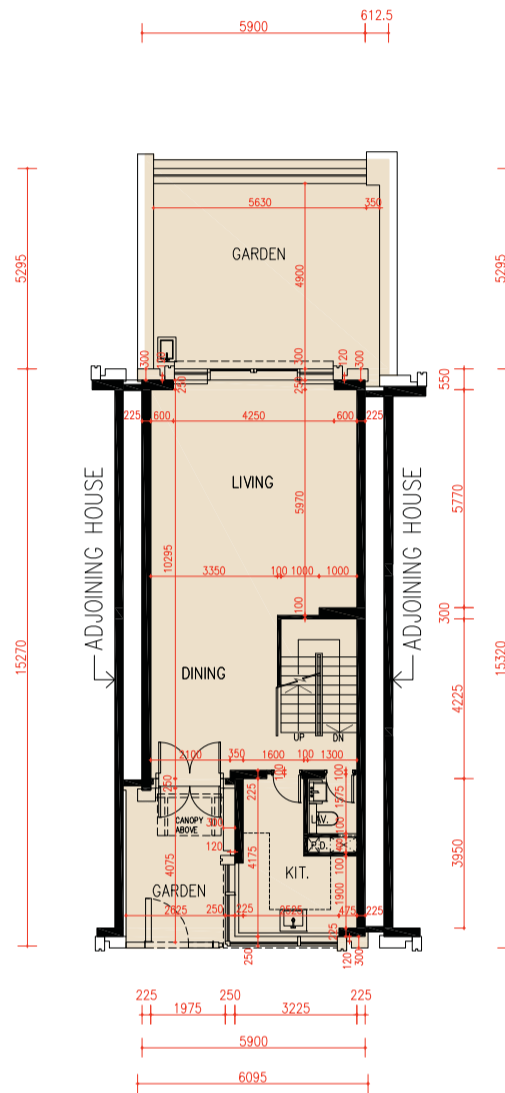

G/F Plan

地下平面圖

scale 比例 0 5 10M (米)

Floor 樓層	The thickness of the floor slabs (excluding plaster) of each house (mm) 每座洋房的樓板(不包括灰泥)的厚度(毫米)	The floor-to-floor height of each house (mm) 每座洋房的層與層之間的高度(毫米)
LG/F 地下低層	200	6950
G/F 地下	175, 200, 250	4500
1/F 一樓	150, 175	4000
2/F 二樓	200, 225	4000
Roof 天台	150	2400

The internal areas of the houses on the upper floors will generally be slightly larger than those on the lower floors because of the reducing thickness of the structural walls on the upper floors. 因洋房的較高樓層的結構牆的厚度遞減,較高樓層的內部面積,一般比較低樓層的內部面積稍大。

Note:

- The dimensions of floor plans are all structural dimensions in millimeter.
- There may be architectural features and/or exposed pipes on external walls of some houses. For details, please refer to the latest approved building plans.
- Common pipes exposed and/or enclosed in cladding are located at/adjacent to flat roof and/or external wall of some houses. For details, please refer to the latest approved building plans and/or electrical and mechanical design drawings.
- There are ceiling bulkheads and/or sunken slab of the above houses at living/dining room, bedrooms, corridors and/or kitchen of the above houses for the air-conditioning system and/or M&E services.
- Please refer to page AL1 of this sales brochure for legend of the terms and abbreviations shown in the floor plan above.
- Floor-to-floor height refers to the height between the top surface of the structural slab of a floor and the top surface of the structural slab of its immediate upper floor.

備註:

- 平面圖所列之尺寸數字為以毫米標示之建築結構尺寸。
- 部份洋房外牆設有建築裝飾及/或外露喉管。詳細資料請參考最新批准之建築圖則。
- 部份洋房的平台及/或外牆設有外露及/或外牆裝飾板內藏之公用喉管。詳細資料請參考最新批准的建築圖則及/或機電設計圖。
- 部份洋房客/飯廳、睡房、走廊及/或廚房有假天花及/或有跌級樓板以內藏冷氣系統及/或機電設備。
- 以上平面圖中顯示之名詞及簡稱請參閱本售樓說明書第AL1頁。
- 層與層之間的高度指該樓層之石屎地台面與上一層石屎地台面之高度距離。



# FLOOR PLANS OF RESIDENTIAL PROPERTIES IN THE DEVELOPMENT

## 發展項目的住宅物業的樓面平面圖

### Remark:

Alterations have been made to 17R Shouson Hill Road, please refer to the "as-is" layout plans on pages AL94 to AL96 for such alterations.

### 備註:

壽山村道17R號經過改動，有關改動請參閱第AL94至AL96頁之現狀平面圖。

17R Shouson Hill Road

壽山村道17R號

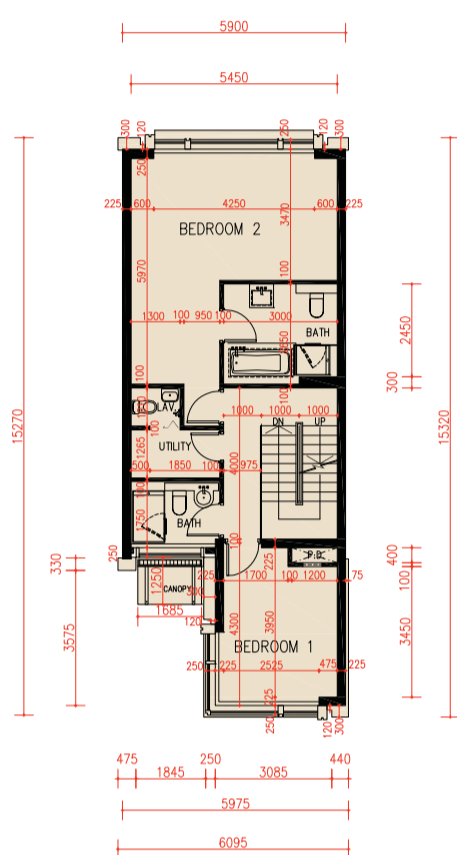

1/F Plan

一樓平面圖

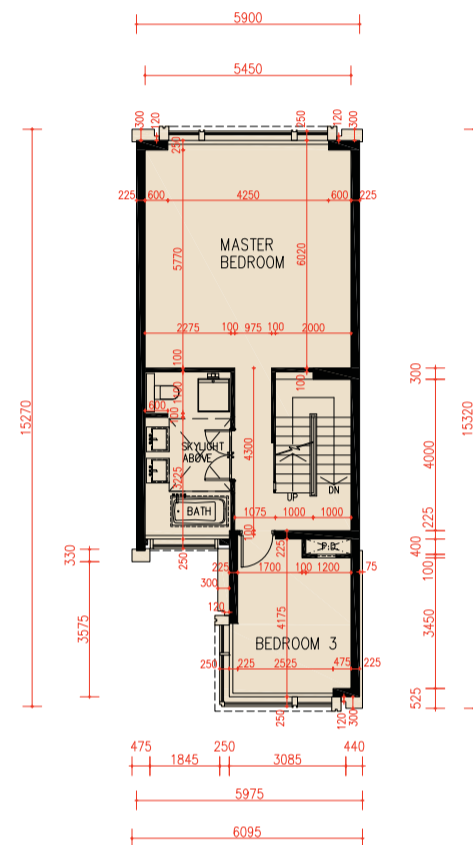

2/F Plan

二樓平面圖

scale 0 5 10M (米)  
比例

Floor 樓層	The thickness of the floor slabs (excluding plaster) of each house (mm) 每座洋房的樓板 (不包括灰泥) 的厚度 (毫米)	The floor-to-floor height of each house (mm) 每座洋房的層與層之間的高度 (毫米)
LG/F 地下低層	200	6950
G/F 地下	175, 200, 250	4500
1/F 一樓	150, 175	4000
2/F 二樓	200, 225	4000
Roof 天台	150	2400

The internal areas of the houses on the upper floors will generally be slightly larger than those on the lower floors because of the reducing thickness of the structural walls on the upper floors. 因洋房的較高樓層的結構牆的厚度遞減，較高樓層的內部面積，一般比較低樓層的內部面積稍大。

### Note:

- The dimensions of floor plans are all structural dimensions in millimeter.
- There may be architectural features and/or exposed pipes on external walls of some houses. For details, please refer to the latest approved building plans.
- Common pipes exposed and/or enclosed in cladding are located at/adjacent to flat roof and/or external wall of some houses. For details, please refer to the latest approved building plans and/or electrical and mechanical design drawings.
- There are ceiling bulkheads and/or sunken slab of the above houses at living/dining room, bedrooms, corridors and/or kitchen of the above houses for the air-conditioning system and/or M&E services.
- Please refer to page AL1 of this sales brochure for legend of the terms and abbreviations shown in the floor plan above.
- Floor-to-floor height refers to the height between the top surface of the structural slab of a floor and the top surface of the structural slab of its immediate upper floor.

### 備註:

- 平面圖所列之尺寸數字為以毫米標示之建築結構尺寸。
- 部份洋房外牆設有建築裝飾及/或外露喉管。詳細資料請參考最新批准之建築圖則。
- 部份洋房的平台及/或外牆設有外露及/或外牆裝飾板內藏之公用喉管。詳細資料請參考最新批准的建築圖則及/或機電設計圖。
- 部份洋房客/飯廳、睡房、走廊及/或廚房有假天花及/或有跌級樓板以內藏冷氣系統及/或機電設備。
- 以上平面圖中顯示之名詞及簡稱請參閱本售樓說明書第AL1頁。
- 層與層之間的高度指該樓層之石屎地台面與上一層石屎地台面之高度距離。

# FLOOR PLANS OF RESIDENTIAL PROPERTIES IN THE DEVELOPMENT

## 發展項目的住宅物業的樓面平面圖

17R Shouson Hill Road

壽山村道17R號

Remark:

Alterations have been made to 17R Shouson Hill Road, please refer to the “as-is” layout plans on pages AL94 to AL96 for such alterations.

備註:

壽山村道17R號經過改動，有關改動請參閱第AL94至AL96頁之現狀平面圖。

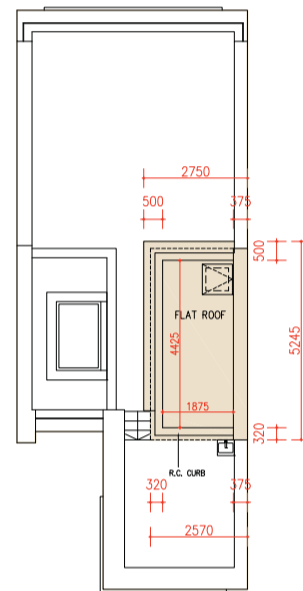
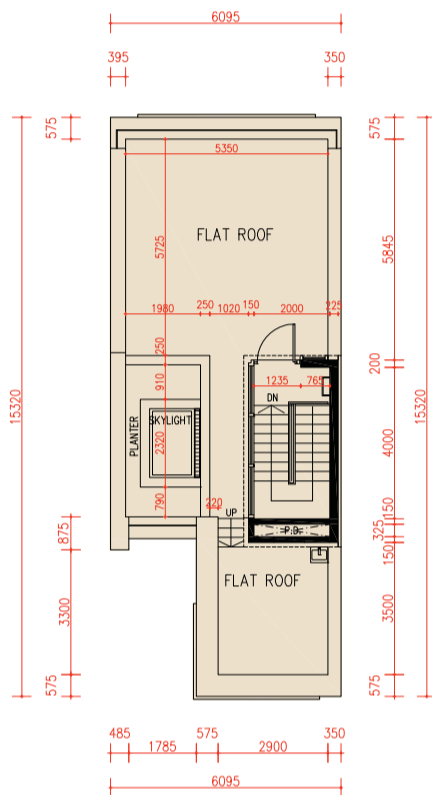

### Roof Plan

天台平面圖

### Upper Roof Plan

上層天台平面圖

scale 比例 0 5 10M (米)

Floor 樓層	The thickness of the floor slabs (excluding plaster) of each house (mm) 每座洋房的樓板(不包括灰泥)的厚度(毫米)	The floor-to-floor height of each house (mm) 每座洋房的層與層之間的高度(毫米)
LG/F 地下低層	200	6950
G/F 地下	175, 200, 250	4500
1/F 一樓	150, 175	4000
2/F 二樓	200, 225	4000
Roof 天台	150	2400

The internal areas of the houses on the upper floors will generally be slightly larger than those on the lower floors because of the reducing thickness of the structural walls on the upper floors. 因洋房的較高樓層的結構牆的厚度遞減，較高樓層的內部面積，一般比較低樓層的內部面積稍大。

Note:

- The dimensions of floor plans are all structural dimensions in millimeter.
- There may be architectural features and/or exposed pipes on external walls of some houses. For details, please refer to the latest approved building plans.
- Common pipes exposed and/or enclosed in cladding are located at/adjacent to flat roof and/or external wall of some houses. For details, please refer to the latest approved building plans and/or electrical and mechanical design drawings.
- There are ceiling bulkheads and/or sunken slab of the above houses at living/dining room, bedrooms, corridors and/or kitchen of the above houses for the air-conditioning system and/or M&E services.
- Please refer to page AL1 of this sales brochure for legend of the terms and abbreviations shown in the floor plan above.
- Floor-to-floor height refers to the height between the top surface of the structural slab of a floor and the top surface of the structural slab of its immediate upper floor.

備註:

- 平面圖所列之尺寸數字為以毫米標示之建築結構尺寸。
- 部份洋房外牆設有建築裝飾及/或外露喉管。詳細資料請參考最新批准之建築圖則。
- 部份洋房的平台及/或外牆設有外露及/或外牆裝飾板內藏之公用喉管。詳細資料請參考最新批准之建築圖則及/或機電設計圖。
- 部份洋房客/飯廳、睡房、走廊及/或廚房有假天花及/或有跌級樓板以內藏冷氣系統及/或機電設備。
- 以上平面圖中顯示之名詞及簡稱請參閱本售樓說明書第AL1頁。
- 層與層之間的高度指該樓層之石屎地台面與上一層石屎地台面之高度距離。

# FLOOR PLANS OF RESIDENTIAL PROPERTIES IN THE DEVELOPMENT

## 發展項目的住宅物業的樓面平面圖

This page is the additional information mentioned in the Remark on Page AL91.

本頁是第 AL91 頁備註附加資料。

17R Shouson Hill Road

壽山村道17R號

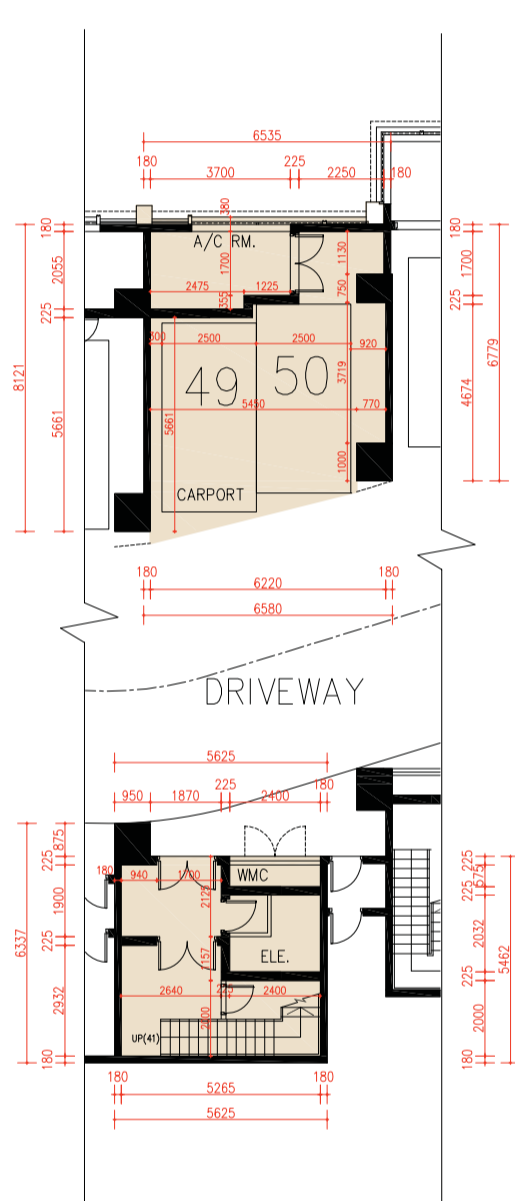

LG/F Plan in “as-is” Layout

地下低層現狀平面圖

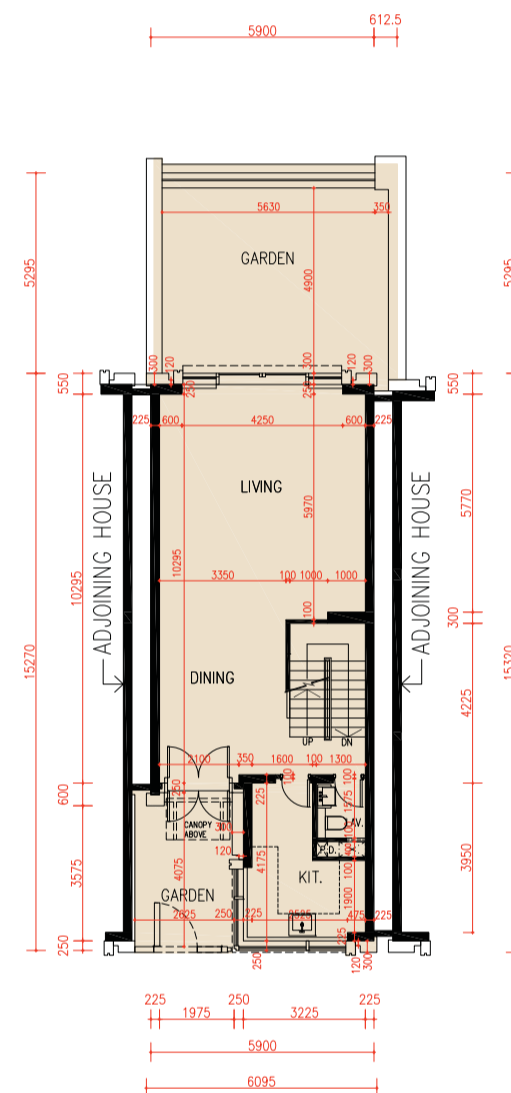

G/F Plan in “as-is” Layout

地下現狀平面圖



Note: The dimensions of floor plans are all structural dimensions in millimeter.  
備註：平面圖所列之尺寸數字為以毫米標示之建築結構尺寸。

# FLOOR PLANS OF RESIDENTIAL PROPERTIES IN THE DEVELOPMENT

## 發展項目的住宅物業的樓面平面圖

17R Shouson Hill Road

壽山村道17R號

This page is the additional information mentioned in the Remark on Page AL92.

本頁是第 AL92 頁備註附加資料。

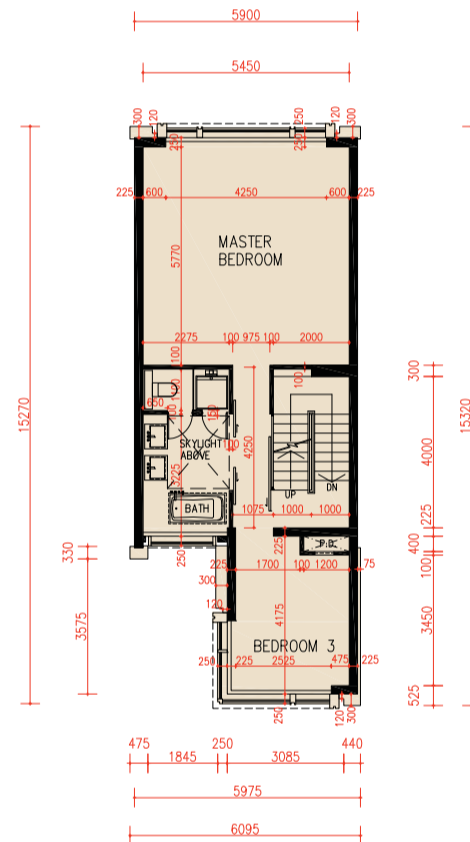
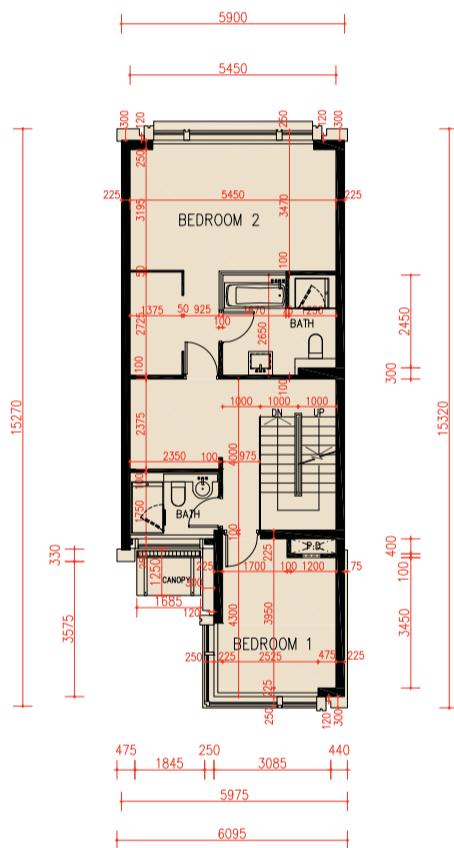

1/F Plan in "as-is" Layout

一樓現狀平面圖

2/F Plan in "as-is" Layout

二樓現狀平面圖

scale 0 5 10M (米)  
比例

Note: The dimensions of floor plans are all structural dimensions in millimeter.  
備註：平面圖所列之尺寸數字為以毫米標示之建築結構尺寸。

# FLOOR PLANS OF RESIDENTIAL PROPERTIES IN THE DEVELOPMENT

## 發展項目的住宅物業的樓面平面圖

This page is the additional information mentioned in the Remark on Page AL93.

本頁是第 AL93 頁備註附加資料。

17R Shouson Hill Road

壽山村道17R號

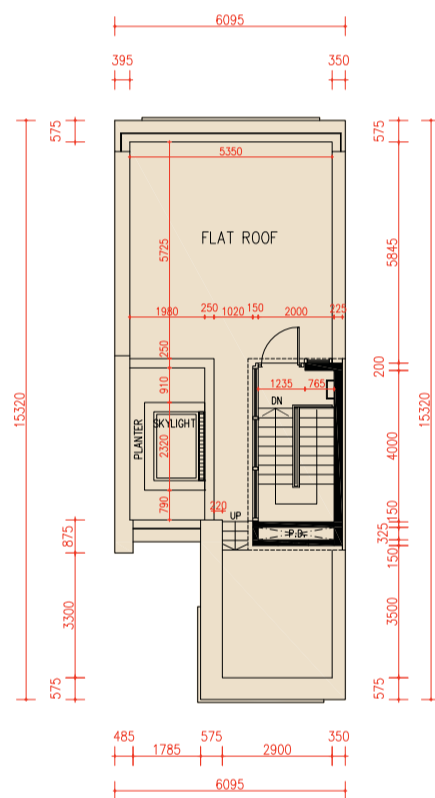

Roof Plan in "as-is" Layout  
天台現狀平面圖

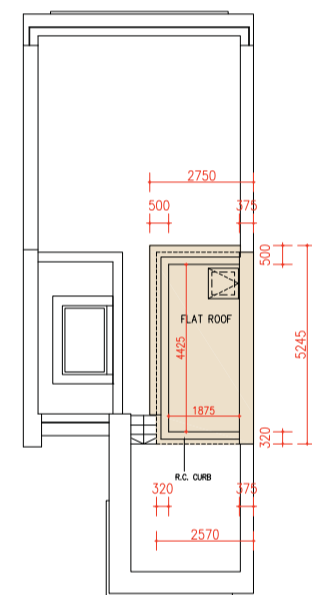

Upper Roof Plan in "as-is" Layout  
上層天台現狀平面圖

scale 0 5 10M (米)  
比例

Note: The dimensions of floor plans are all structural dimensions in millimeter.  
備註：平面圖所列之尺寸數字為以毫米標示之建築結構尺寸。



# FLOOR PLANS OF RESIDENTIAL PROPERTIES IN THE DEVELOPMENT

## 發展項目的住宅物業的樓面平面圖

19A Shouson Hill Road

壽山村道19A號

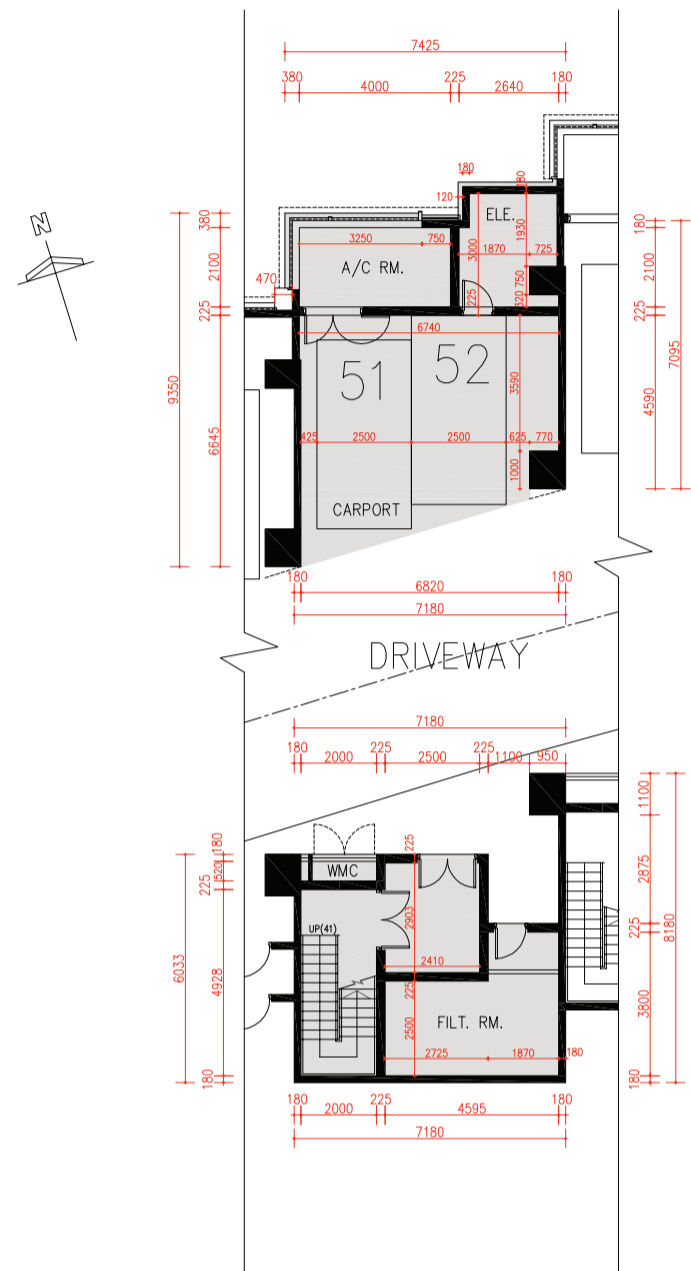

LG/F Plan

地下低層平面圖

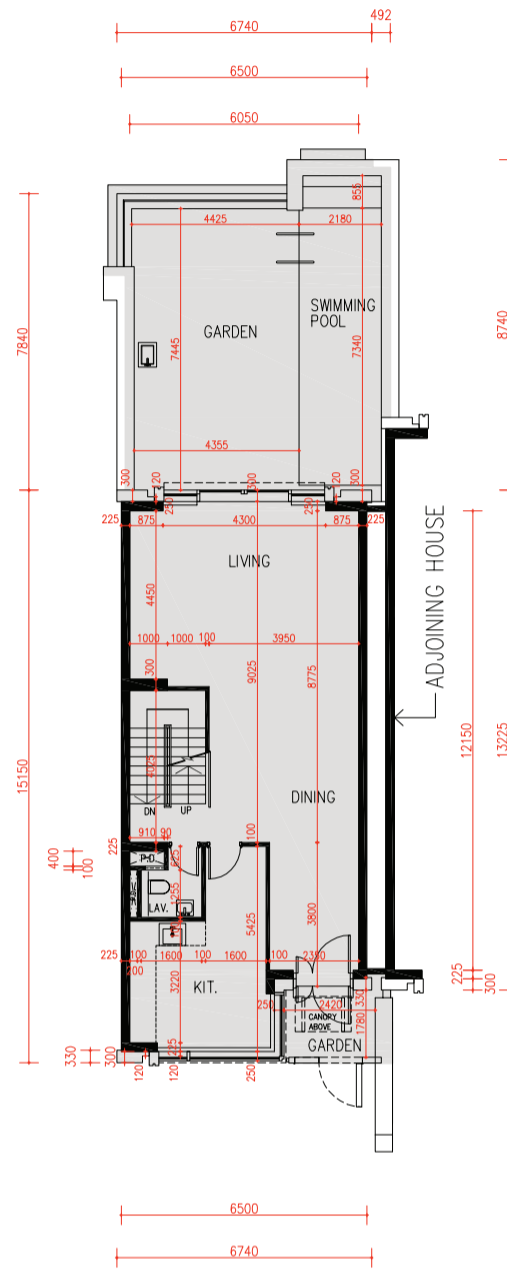

G/F Plan

地下平面圖

scale 比例 0 5 10M (米)

Floor 樓層	The thickness of the floor slabs (excluding plaster) of each house (mm) 每座洋房的樓板(不包括灰泥)的厚度(毫米)	The floor-to-floor height of each house (mm) 每座洋房的層與層之間的高度(毫米)
LG/F 地下低層	175, 200	6950
G/F 地下	175, 200, 250	4500
1/F 一樓	150, 175	4000
2/F 二樓	200	4000
Roof 天台	150	2400

The internal areas of the houses on the upper floors will generally be slightly larger than those on the lower floors because of the reducing thickness of the structural walls on the upper floors. 因洋房的較高樓層的結構牆的厚度遞減，較高樓層的內部面積，一般比較低樓層的內部面積稍大。

Note:

- The dimensions of floor plans are all structural dimensions in millimeter.
- There may be architectural features and/or exposed pipes on external walls of some houses. For details, please refer to the latest approved building plans.
- Common pipes exposed and/or enclosed in cladding are located at/adjacent to flat roof and/or external wall of some houses. For details, please refer to the latest approved building plans and/or electrical and mechanical design drawings.
- There are ceiling bulkheads and/or sunken slab of the above houses at living/dining room, bedrooms, corridors and/or kitchen of the above houses for the air-conditioning system and/or M&E services.
- Please refer to page AL1 of this sales brochure for legend of the terms and abbreviations shown in the floor plan above.
- Floor-to-floor height refers to the height between the top surface of the structural slab of a floor and the top surface of the structural slab of its immediate upper floor.

備註:

- 平面圖所列之尺寸數字為以毫米標示之建築結構尺寸。
- 部份洋房外牆設有建築裝飾及/或外露喉管。詳細資料請參考最新批准之建築圖則。
- 部份洋房的平台及/或外牆設有外露及/或外牆裝飾板內藏之公用喉管。詳細資料請參考最新批准的建築圖則及/或機電設計圖。
- 部份洋房客/飯廳、睡房、走廊及/或廚房有假天花及/或有跌級樓板以內藏冷氣系統及/或機電設備。
- 以上平面圖中顯示之名詞及簡稱請參閱本售樓說明書第AL1頁。
- 層與層之間的高度指該樓層之石屎地台面與上一層石屎地台面之高度距離。

# FLOOR PLANS OF RESIDENTIAL PROPERTIES IN THE DEVELOPMENT

## 發展項目的住宅物業的樓面平面圖

19A Shouson Hill Road

壽山村道19A號

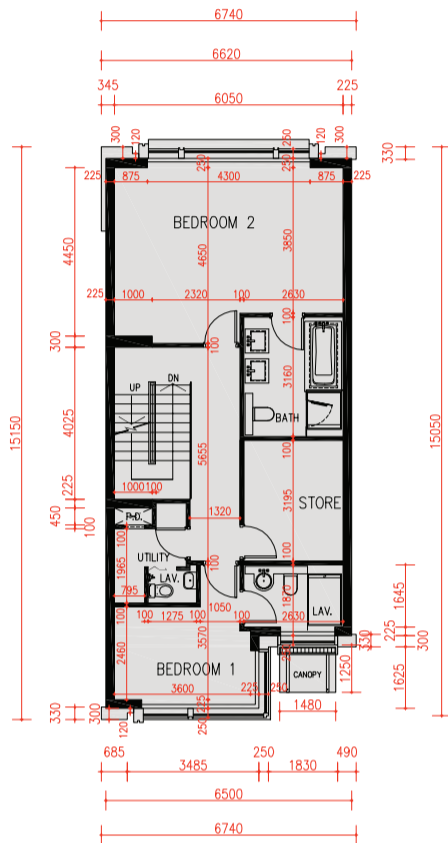

1/F Plan  
一樓平面圖

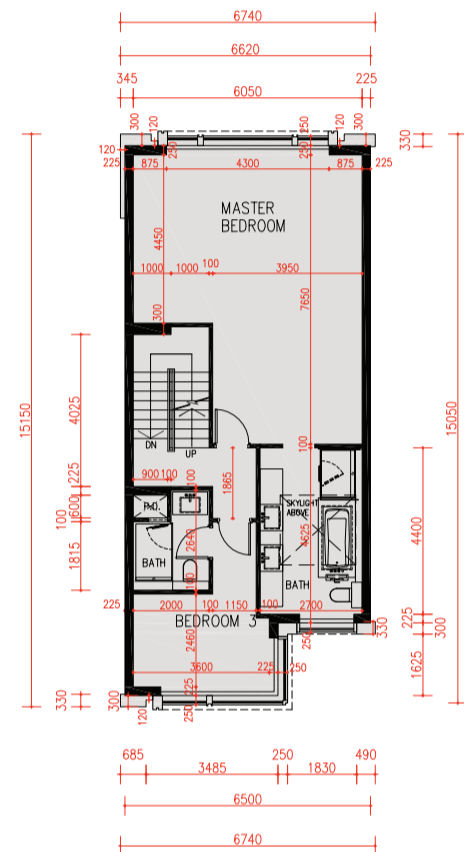

2/F Plan  
二樓平面圖

scale 0 5 10M (米)  
比例 0 5 10M (米)

Floor 樓層	The thickness of the floor slabs (excluding plaster) of each house (mm) 每座洋房的樓板(不包括灰泥)的厚度(毫米)	The floor-to-floor height of each house (mm) 每座洋房的層與層之間的高度(毫米)
LG/F 地下低層	175, 200	6950
G/F 地下	175, 200, 250	4500
1/F 一樓	150, 175	4000
2/F 二樓	200	4000
Roof 天台	150	2400

The internal areas of the houses on the upper floors will generally be slightly larger than those on the lower floors because of the reducing thickness of the structural walls on the upper floors. 因洋房的較高樓層的結構牆的厚度遞減，較高樓層的內部面積，一般比較低樓層的內部面積稍大。

Note:

- The dimensions of floor plans are all structural dimensions in millimeter.
- There may be architectural features and/or exposed pipes on external walls of some houses. For details, please refer to the latest approved building plans.
- Common pipes exposed and/or enclosed in cladding are located at/adjacent to flat roof and/or external wall of some houses. For details, please refer to the latest approved building plans and/or electrical and mechanical design drawings.
- There are ceiling bulkheads and/or sunken slab of the above houses at living/dining room, bedrooms, corridors and/or kitchen of the above houses for the air-conditioning system and/or M&E services.
- Please refer to page AL1 of this sales brochure for legend of the terms and abbreviations shown in the floor plan above.
- Floor-to-floor height refers to the height between the top surface of the structural slab of a floor and the top surface of the structural slab of its immediate upper floor.

備註：

- 平面圖所列之尺寸數字為以毫米標示之建築結構尺寸。
- 部份洋房外牆設有建築裝飾及/或外露喉管。詳細資料請參考最新批准之建築圖則。
- 部份洋房的平台及/或外牆設有外露及/或外牆裝飾板內藏之公用喉管。詳細資料請參考最新批准的建築圖則及/或機電設計圖。
- 部份洋房客/飯廳、睡房、走廊及/或廚房有假天花及/或有跌級樓板以內藏冷氣系統及/或機電設備。
- 以上平面圖中顯示之名詞及簡稱請參閱本售樓說明書第 AL1 頁。
- 層與層之間的高度指該樓層之石屎地台面與上一層石屎地台面之高度距離。

# FLOOR PLANS OF RESIDENTIAL PROPERTIES IN THE DEVELOPMENT

## 發展項目的住宅物業的樓面平面圖

19A Shouson Hill Road

壽山村道19A號

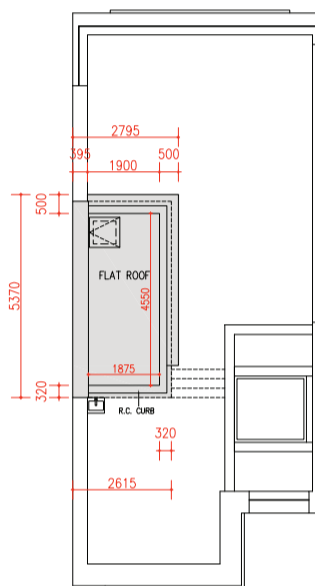
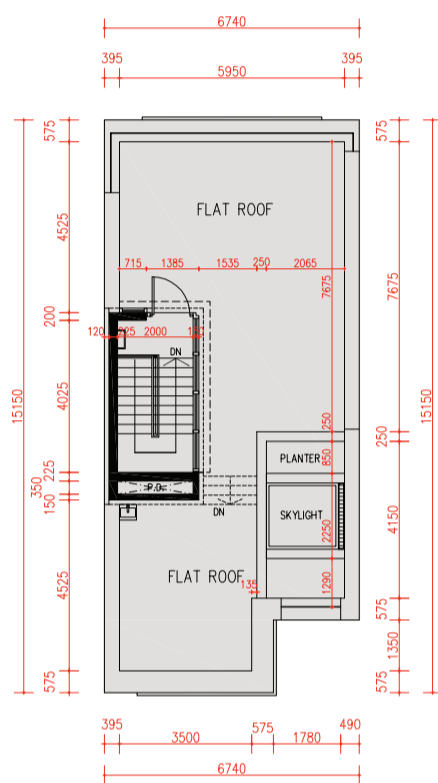

### Roof Plan

天台平面圖

### Upper Roof Plan

上層天台平面圖

scale 比例 0 5 10M (米)

Floor 樓層	The thickness of the floor slabs (excluding plaster) of each house (mm) 每座洋房的樓板(不包括灰泥)的厚度(毫米)	The floor-to-floor height of each house (mm) 每座洋房的層與層之間的高度(毫米)
LG/F 地下低層	175, 200	6950
G/F 地下	175, 200, 250	4500
1/F 一樓	150, 175	4000
2/F 二樓	200	4000
Roof 天台	150	2400

The internal areas of the houses on the upper floors will generally be slightly larger than those on the lower floors because of the reducing thickness of the structural walls on the upper floors. 因洋房的較高樓層的結構牆的厚度遞減，較高樓層的內部面積，一般比較低樓層的內部面積稍大。

Note:

- The dimensions of floor plans are all structural dimensions in millimeter.
- There may be architectural features and/or exposed pipes on external walls of some houses. For details, please refer to the latest approved building plans.
- Common pipes exposed and/or enclosed in cladding are located at/adjacent to flat roof and/or external wall of some houses. For details, please refer to the latest approved building plans and/or electrical and mechanical design drawings.
- There are ceiling bulkheads and/or sunken slab of the above houses at living/dining room, bedrooms, corridors and/or kitchen of the above houses for the air-conditioning system and/or M&E services.
- Please refer to page AL1 of this sales brochure for legend of the terms and abbreviations shown in the floor plan above.
- Floor-to-floor height refers to the height between the top surface of the structural slab of a floor and the top surface of the structural slab of its immediate upper floor.

備註：

- 平面圖所列之尺寸數字為以毫米標示之建築結構尺寸。
- 部份洋房外牆設有建築裝飾及/或外露喉管。詳細資料請參考最新批准之建築圖則。
- 部份洋房的平台及/或外牆設有外露及/或外牆裝飾板內藏之公用喉管。詳細資料請參考最新批准之建築圖則及/或機電設計圖。
- 部份洋房客/飯廳、睡房、走廊及/或廚房有假天花及/或有跌級樓板以內藏冷氣系統及/或機電設備。
- 以上平面圖中顯示之名詞及簡稱請參閱本售樓說明書第 AL1 頁。
- 層與層之間的高度指該樓層之石屎地台面與上一層石屎地台面之高度距離。

# FLOOR PLANS OF RESIDENTIAL PROPERTIES IN THE DEVELOPMENT

## 發展項目的住宅物業的樓面平面圖

19B Shouson Hill Road

壽山村道19B號

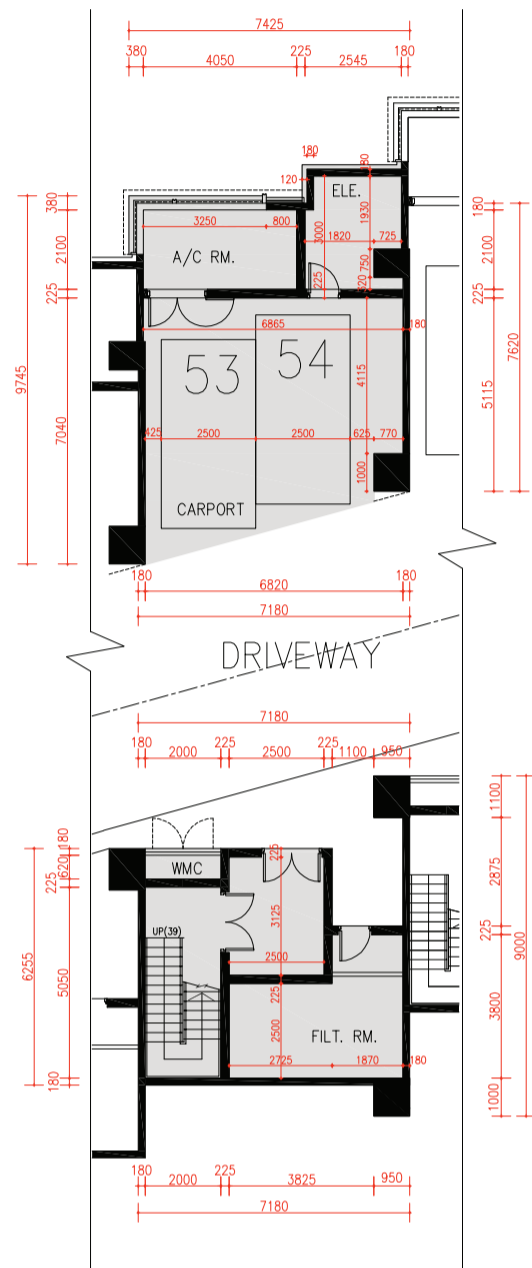

LG/F Plan  
地下低層平面圖

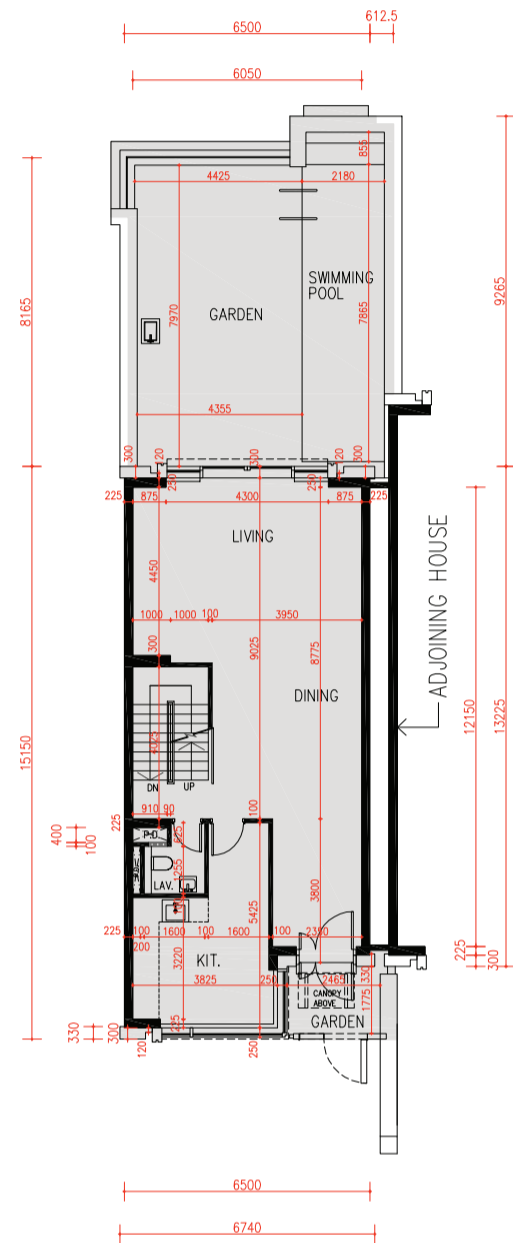

G/F Plan  
地下平面圖

scale 0 5 10M (米)  
比例

Floor 樓層	The thickness of the floor slabs (excluding plaster) of each house (mm) 每座洋房的樓板(不包括灰泥)的厚度(毫米)	The floor-to-floor height of each house (mm) 每座洋房的層與層之間的高度(毫米)
LG/F 地下低層	175, 200	6650
G/F 地下	175, 200, 250	4500
1/F 一樓	150, 175	4000
2/F 二樓	200	4000
Roof 天台	150	2400

The internal areas of the houses on the upper floors will generally be slightly larger than those on the lower floors because of the reducing thickness of the structural walls on the upper floors. 因洋房的較高樓層的結構牆的厚度遞減，較高樓層的內部面積，一般比較低樓層的內部面積稍大。

Note:

- The dimensions of floor plans are all structural dimensions in millimeter.
- There may be architectural features and/or exposed pipes on external walls of some houses. For details, please refer to the latest approved building plans.
- Common pipes exposed and/or enclosed in cladding are located at/adjacent to flat roof and/or external wall of some houses. For details, please refer to the latest approved building plans and/or electrical and mechanical design drawings.
- There are ceiling bulkheads and/or sunken slab of the above houses at living/dining room, bedrooms, corridors and/or kitchen of the above houses for the air-conditioning system and/or M&E services.
- Please refer to page AL1 of this sales brochure for legend of the terms and abbreviations shown in the floor plan above.
- Floor-to-floor height refers to the height between the top surface of the structural slab of a floor and the top surface of the structural slab of its immediate upper floor.

備註:

- 平面圖所列之尺寸數字為以毫米標示之建築結構尺寸。
- 部份洋房外牆設有建築裝飾及/或外露喉管。詳細資料請參考最新批准之建築圖則。
- 部份洋房的平台及/或外牆設有外露及/或外牆裝飾板內藏之公用喉管。詳細資料請參考最新批准的建築圖則及/或機電設計圖。
- 部份洋房客/飯廳、睡房、走廊及/或廚房有假天花及/或有跌級樓板以內藏冷氣系統及/或機電設備。
- 以上平面圖中顯示之名詞及簡稱請參閱本售樓說明書第 AL1 頁。
- 層與層之間的高度指該樓層之石屎地台面與上一層石屎地台面之高度距離。

# FLOOR PLANS OF RESIDENTIAL PROPERTIES IN THE DEVELOPMENT

## 發展項目的住宅物業的樓面平面圖

19B Shouson Hill Road

壽山村道19B號

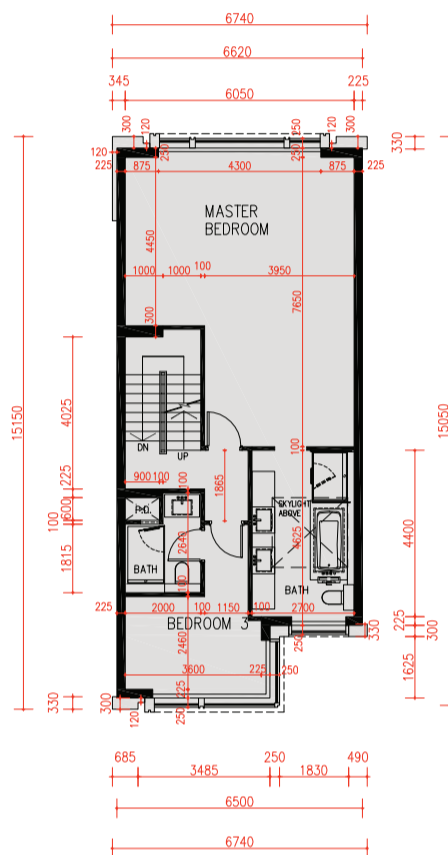
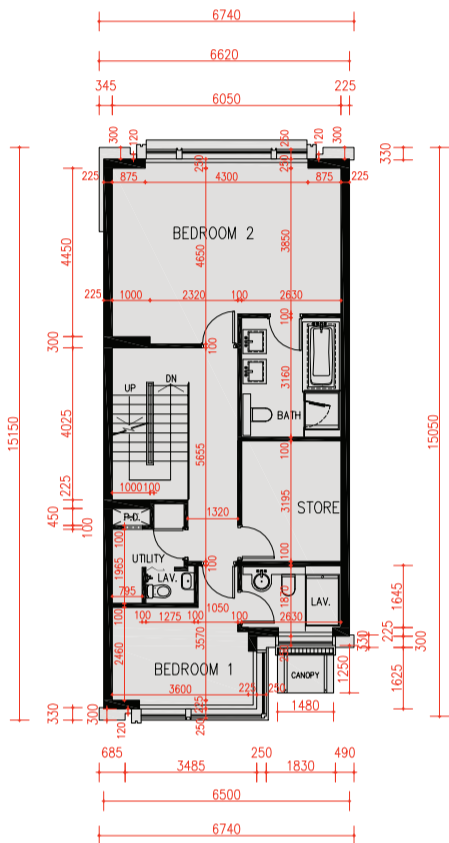

### 1/F Plan

一樓平面圖

### 2/F Plan

二樓平面圖

scale 比例 0 5 10M (米)

Floor 樓層	The thickness of the floor slabs (excluding plaster) of each house (mm) 每座洋房的樓板(不包括灰泥)的厚度(毫米)	The floor-to-floor height of each house (mm) 每座洋房的層與層之間的高度(毫米)
LG/F 地下低層	175, 200	6650
G/F 地下	175, 200, 250	4500
1/F 一樓	150, 175	4000
2/F 二樓	200	4000
Roof 天台	150	2400

The internal areas of the houses on the upper floors will generally be slightly larger than those on the lower floors because of the reducing thickness of the structural walls on the upper floors. 因洋房的較高樓層的結構牆的厚度遞減，較高樓層的內部面積，一般比較低樓層的內部面積稍大。

Note:

- The dimensions of floor plans are all structural dimensions in millimeter.
- There may be architectural features and/or exposed pipes on external walls of some houses. For details, please refer to the latest approved building plans.
- Common pipes exposed and/or enclosed in cladding are located at/adjacent to flat roof and/or external wall of some houses. For details, please refer to the latest approved building plans and/or electrical and mechanical design drawings.
- There are ceiling bulkheads and/or sunken slab of the above houses at living/dining room, bedrooms, corridors and/or kitchen of the above houses for the air-conditioning system and/or M&E services.
- Please refer to page AL1 of this sales brochure for legend of the terms and abbreviations shown in the floor plan above.
- Floor-to-floor height refers to the height between the top surface of the structural slab of a floor and the top surface of the structural slab of its immediate upper floor.

備註：

- 平面圖所列之尺寸數字為以毫米標示之建築結構尺寸。
- 部份洋房外牆設有建築裝飾及/或外露喉管。詳細資料請參考最新批准之建築圖則。
- 部份洋房的平台及/或外牆設有外露及/或外牆裝飾板內藏之公用喉管。詳細資料請參考最新批准的建築圖則及/或機電設計圖。
- 部份洋房客/飯廳、睡房、走廊及/或廚房有假天花及/或有跌級樓板以內藏冷氣系統及/或機電設備。
- 以上平面圖中顯示之名詞及簡稱請參閱本售樓說明書第 AL1 頁。
- 層與層之間的高度指該樓層之石屎地台面與上一層石屎地台面之高度距離。