

# AREA OF RESIDENTIAL PROPERTIES IN THE DEVELOPMENT

## 發展項目中的住宅物業的面積

Description of Residential Property 物業的描述			Saleable Area (including balcony, utility platform and verandah, if any) sq. metre (sq.ft.) 實用面積 (包括露台, 工作平台及陽台 (如有)) 平方米(平方呎)	Area of other specified items (Not included in the Saleable Area) sq. metre (sq.ft.) 其他指明項目的面積 (不計算入實用面積) 平方米(平方呎)									
Block Name 大廈名稱	Floor 樓層	Unit 單位		Air- conditioning plant room 空調機房	Bay window 窗台	Cockloft 閣樓	Flat roof 平台	Garden 花園	Parking space 停車位	Roof 天台	Stairhood 梯屋	Terrace 前庭	Yard 庭院
Tower 1 第1座	7/F 7樓	A	172.991 (1862) Balcony 露台 :- Utility Platform 工作平台 :- Verandah 陽台 :-	3.186 (34)	1.488 (16)	-	44.329 (477)	-	-	-	-	-	-
		B	159.736 (1719) Balcony 露台 :- Utility Platform 工作平台 :- Verandah 陽台 :-	2.305 (25)	1.523 (16)	-	27.035 (291)	-	-	-	-	-	-
	8/F - 18/F, 22/F - 26/F 8樓至18樓, 22樓至26樓	A	180.316 (1941) Balcony 露台 : 4.990 (54) Utility Platform 工作平台 : 2.335 (25) Verandah 陽台 :-	3.186 (34)	1.488 (16)	-	-	-	-	-	-	-	-
	27/F - 36/F 27樓至36樓	A	180.316 (1941) Balcony 露台 : 4.990 (54) Utility Platform 工作平台 : 2.335 (25) Verandah 陽台 :-	3.186 (34)	1.488 (16)	-	-	-	-	-	-	-	-
	8/F - 18/F, 22/F - 36/F 8樓至18樓, 22樓至36樓	B	166.782 (1795) Balcony 露台 : 4.711 (51) Utility Platform 工作平台 : 2.335 (25) Verandah 陽台 :-	2.305 (25)	1.523 (16)	-	-	-	-	-	-	-	-
	20/F - 21/F 20樓至21樓	A	181.960 (1959) Balcony 露台 : 4.990 (54) Utility Platform 工作平台 : 2.335 (25) Verandah 陽台 :-	5.491 (59)	1.488 (16)	-	-	-	-	-	-	-	-
	37/F 37樓	A	242.275 (2608) Balcony 露台 :- Utility Platform 工作平台 : 2.460 (26) Verandah 陽台 :-	5.461 (59)	1.821 (20)	-	51.239 (552)	-	-	-	-	-	-

### Notes :

- The residential floors start from 7/F in all towers of the Development.
- There is no Tower 4 in the Development.
- There are no 4/F, 13/F, 14/F, 24/F and 34/F in all towers of the Development.
- There are no 6/F and 19/F in Tower 1 and Tower 2 and no 20/F and 21/F in Tower 6, Tower 7, Tower 9 and Tower 10.
- There are no 2/F in Tower 3, Tower 5, Tower 6, Tower 7, Tower 8, Tower 9 and Tower 10.
- The saleable area of the residential property and the floor area of balcony, utility platform and verandah (if any) are calculated in accordance with Section 8 of the Residential Properties (First-hand Sales) Ordinance; and the areas of the other specified items (not included in the saleable area) are calculated in accordance with Part 2 of Schedule 2 of the Residential Properties (First-hand Sales) Ordinance.
- The areas as specified below in square feet are converted at a rate of 1 square metre = 10.764 square feet and rounded to the nearest whole square foot, which may be slightly different from that shown in square metre.

### 備註 :

- 發展項目內所有座樓之住宅由7樓開始。
- 發展項目不設第4座。
- 發展項目內所有座樓均不設4樓、13樓、14樓、24樓及34樓。
- 第1座及第2座均不設6樓及19樓；第6座、第7座、第9座及第10座均不設20樓及21樓。
- 第3座、第5座、第6座、第7座、第8座、第9座及第10座均不設2樓。
- 住宅物業的實用面積、以及露台、工作平台及陽台(如有)的樓面面積，是按照《一手住宅物業銷售條例》第8條計算得出的。其他指明項目的面積(不計算入實用面積)，是按照《一手住宅物業銷售條例》附表2第2部計算得出的。
- 下述所列之平方呎面積是以1平方米=10.764平方呎換算，並以四捨五入至整數平方呎，平方呎與平方米之數字可能有些微差異。

# AREA OF RESIDENTIAL PROPERTIES IN THE DEVELOPMENT

## 發展項目中的住宅物業的面積

Description of Residential Property 物業的描述			Saleable Area (including balcony, utility platform and verandah, if any) sq. metre (sq.ft.) 實用面積 (包括露台, 工作平台及陽台 (如有)) 平方米(平方呎)	Area of other specified items (Not included in the Saleable Area) sq. metre (sq.ft.) 其他指明項目的面積 (不計算入實用面積) 平方米(平方呎)									
Block Name 大廈名稱	Floor 樓層	Unit 單位		Air- conditioning plant room 空調機房	Bay window 窗台	Cockloft 閣樓	Flat roof 平台	Garden 花園	Parking space 停車位	Roof 天台	Stairhood 梯屋	Terrace 前庭	Yard 庭院
Tower 1 第1座	38/F & 39/F 38樓及39樓	A	280.478 (3019) Balcony 露台 :- Utility Platform 工作平台 : 2.460 (26) Verandah 陽台 :-	5.461 (59)	1.821 (20)	-	90.645 (976)	-	-	114.741 (1235)	-	-	-
Tower 2 第2座	7/F 7樓	A	164.262 (1768) Balcony 露台 :- Utility Platform 工作平台 :- Verandah 陽台 :-	3.186 (34)	1.478 (16)	-	45.955 (495)	-	-	-	-	-	-
		B	159.736 (1719) Balcony 露台 :- Utility Platform 工作平台 :- Verandah 陽台 :-	2.305 (25)	1.523 (16)	-	27.035 (291)	-	-	-	-	-	-
	8/F - 18/F, 22/F - 36/F 8樓至18樓, 22樓至36樓	A	171.255 (1843) Balcony 露台 : 4.711 (51) Utility Platform 工作平台 : 2.335 (25) Verandah 陽台 :-	3.186 (34)	1.478 (16)	-	-	-	-	-	-	-	-
	8/F - 12/F 8樓至12樓	B	166.782 (1795) Balcony 露台 : 4.711 (51) Utility Platform 工作平台 : 2.335 (25) Verandah 陽台 :-	2.305 (25)	1.523 (16)	-	-	-	-	-	-	-	-
	15/F - 18/F, 22/F - 36/F 15樓至18樓, 22樓至36樓	B	166.782 (1795) Balcony 露台 : 4.711 (51) Utility Platform 工作平台 : 2.335 (25) Verandah 陽台 :-	2.305 (25)	1.523 (16)	-	-	-	-	-	-	-	-
	20/F - 21/F 20樓至21樓	A	172.898 (1861) Balcony 露台 : 4.711 (51) Utility Platform 工作平台 : 2.335 (25) Verandah 陽台 :-	5.491 (59)	1.478 (16)	-	-	-	-	-	-	-	-

### Notes :

- The residential floors start from 7/F in all towers of the Development.
- There is no Tower 4 in the Development.
- There are no 4/F, 13/F, 14/F, 24/F and 34/F in all towers of the Development.
- There are no 6/F and 19/F in Tower 1 and Tower 2 and no 20/F and 21/F in Tower 6, Tower 7, Tower 9 and Tower 10.
- There are no 2/F in Tower 3, Tower 5, Tower 6, Tower 7, Tower 8, Tower 9 and Tower 10.
- The saleable area of the residential property and the floor area of balcony, utility platform and verandah (if any) are calculated in accordance with Section 8 of the Residential Properties (First-hand Sales) Ordinance; and the areas of the other specified items (not included in the saleable area) are calculated in accordance with Part 2 of Schedule 2 of the Residential Properties (First-hand Sales) Ordinance.
- The areas as specified below in square feet are converted at a rate of 1 square metre = 10.764 square feet and rounded to the nearest whole square foot, which may be slightly different from that shown in square metre.

### 備註 :

- 發展項目內所有座樓之住宅由7樓開始。
- 發展項目不設第4座。
- 發展項目內所有座樓均不設4樓、13樓、14樓、24樓及34樓。
- 第1座及第2座均不設6樓及19樓；第6座、第7座、第9座及第10座均不設20樓及21樓。
- 第3座、第5座、第6座、第7座、第8座、第9座及第10座均不設2樓。
- 住宅物業的實用面積、以及露台、工作平台及陽台(如有)的樓面面積，是按照《一手住宅物業銷售條例》第8條計算得出的。其他指明項目的面積(不計算入實用面積)，是按照《一手住宅物業銷售條例》附表2第2部計算得出的。
- 下述所列之平方呎面積是以1平方米=10.764平方呎換算，並以四捨五入至整數平方呎，平方呎與平方米之數字可能有些微差異。

# AREA OF RESIDENTIAL PROPERTIES IN THE DEVELOPMENT

## 發展項目中的住宅物業的面積

Description of Residential Property 物業的描述			Saleable Area (including balcony, utility platform and verandah, if any) sq. metre (sq.ft.) 實用面積 (包括露台, 工作平台及陽台 (如有)) 平方米(平方呎)	Area of other specified items (Not included in the Saleable Area) sq. metre (sq.ft.) 其他指明項目的面積 (不計算入實用面積) 平方米(平方呎)									
Block Name 大廈名稱	Floor 樓層	Unit 單位		Air- conditioning plant room 空調機房	Bay window 窗台	Cockloft 閣樓	Flat roof 平台	Garden 花園	Parking space 停車位	Roof 天台	Stairhood 梯屋	Terrace 前庭	Yard 庭院
Tower 2 第2座	37/F 37樓	A	239.777 (2581) Balcony 露台 :- Utility Platform 工作平台 : 2.460 (26) Verandah 陽台 :-	5.461 (59)	1.821 (20)	-	47.091 (507)	-	-	-	-	-	-
	38/F & 39/F 38樓及39樓	A	280.946 (3024) Balcony 露台 :- Utility Platform 工作平台 : 2.460 (26) Verandah 陽台 :-	5.461 (59)	1.821 (20)	-	89.039 (958)	-	-	115.654 (1245)	-	-	-
Tower 3 第3座	7/F 7樓	A	142.936 (1539) Balcony 露台 :- Utility Platform 工作平台 :- Verandah 陽台 :-	-	1.504 (16)	-	53.005 (571)	-	-	-	-	-	-
		B	140.809 (1516) Balcony 露台 :- Utility Platform 工作平台 :- Verandah 陽台 :-	-	1.504 (16)	-	55.791 (601)	-	-	-	-	-	-
		C	67.171 (723) Balcony 露台 :- Utility Platform 工作平台 :- Verandah 陽台 :-	-	2.644 (28)	-	29.863 (321)	-	-	-	-	-	-

### Notes :

- The residential floors start from 7/F in all towers of the Development.
- There is no Tower 4 in the Development.
- There are no 4/F, 13/F, 14/F, 24/F and 34/F in all towers of the Development.
- There are no 6/F and 19/F in Tower 1 and Tower 2 and no 20/F and 21/F in Tower 6, Tower 7, Tower 9 and Tower 10.
- There are no 2/F in Tower 3, Tower 5, Tower 6, Tower 7, Tower 8, Tower 9 and Tower 10.
- The saleable area of the residential property and the floor area of balcony, utility platform and verandah (if any) are calculated in accordance with Section 8 of the Residential Properties (First-hand Sales) Ordinance; and the areas of the other specified items (not included in the saleable area) are calculated in accordance with Part 2 of Schedule 2 of the Residential Properties (First-hand Sales) Ordinance.
- The areas as specified below in square feet are converted at a rate of 1 square metre = 10.764 square feet and rounded to the nearest whole square foot, which may be slightly different from that shown in square metre.

### 備註 :

- 發展項目內所有座樓之住宅由7樓開始。
- 發展項目不設第4座。
- 發展項目內所有座樓均不設4樓、13樓、14樓、24樓及34樓。
- 第1座及第2座均不設6樓及19樓；第6座、第7座、第9座及第10座均不設20樓及21樓。
- 第3座、第5座、第6座、第7座、第8座、第9座及第10座均不設2樓。
- 住宅物業的實用面積、以及露台、工作平台及陽台(如有)的樓面面積，是按照《一手住宅物業銷售條例》第8條計算得出的。其他指明項目的面積(不計算入實用面積)，是按照《一手住宅物業銷售條例》附表2第2部計算得出的。
- 下述所列之平方呎面積是以1平方米=10.764平方呎換算，並以四捨五入至整數平方呎，平方呎與平方米之數字可能有些微差異。

# AREA OF RESIDENTIAL PROPERTIES IN THE DEVELOPMENT

## 發展項目中的住宅物業的面積

Description of Residential Property 物業的描述			Saleable Area (including balcony, utility platform and verandah, if any) sq. metre (sq.ft.) 實用面積 (包括露台, 工作平台及陽台 (如有)) 平方米(平方呎)	Area of other specified items (Not included in the Saleable Area) sq. metre (sq.ft.) 其他指明項目的面積 (不計算入實用面積) 平方米(平方呎)									
Block Name 大廈名稱	Floor 樓層	Unit 單位		Air- conditioning plant room 空調機房	Bay window 窗台	Cockloft 閣樓	Flat roof 平台	Garden 花園	Parking space 停車位	Roof 天台	Stairhood 梯屋	Terrace 前庭	Yard 庭院
Tower 3 第3座	8/F - 36/F 8樓至36樓	A	146.972 (1582) Balcony 露台 : 4.022 (43) Utility Platform 工作平台 : - Verandah 陽台 : -	-	1.504 (16)	-	-	-	-	-	-	-	
		B	144.872 (1559) Balcony 露台 : 4.022 (43) Utility Platform 工作平台 : - Verandah 陽台 : -	-	1.504 (16)	-	-	-	-	-	-	-	
		C	70.994 (764) Balcony 露台 : 2.280 (25) Utility Platform 工作平台 : 1.500 (16) Verandah 陽台 : -	-	2.644 (28)	-	-	-	-	-	-	-	
	37/F 37樓	A	201.328 (2167) Balcony 露台 : 4.064 (44) Utility Platform 工作平台 : - Verandah 陽台 : -	-	-	-	64.957 (699)	-	-	-	-	-	
	37/F - 38/F 37樓至38樓	C	132.287 (1424) Balcony 露台 : - Utility Platform 工作平台 : - Verandah 陽台 : -	-	-	-	11.079 (119)	-	-	5.756 (62)	6.935 (75)	-	
	38/F 38樓	A	205.286 (2210) Balcony 露台 : 4.064 (44) Utility Platform 工作平台 : - Verandah 陽台 : -	-	-	-	-	-	8.131 (88)	7.800 (84)	-	-	

### Notes :

- The residential floors start from 7/F in all towers of the Development.
- There is no Tower 4 in the Development.
- There are no 4/F, 13/F, 14/F, 24/F and 34/F in all towers of the Development.
- There are no 6/F and 19/F in Tower 1 and Tower 2 and no 20/F and 21/F in Tower 6, Tower 7, Tower 9 and Tower 10.
- There are no 2/F in Tower 3, Tower 5, Tower 6, Tower 7, Tower 8, Tower 9 and Tower 10.
- The saleable area of the residential property and the floor area of balcony, utility platform and verandah (if any) are calculated in accordance with Section 8 of the Residential Properties (First-hand Sales) Ordinance; and the areas of the other specified items (not included in the saleable area) are calculated in accordance with Part 2 of Schedule 2 of the Residential Properties (First-hand Sales) Ordinance.
- The areas as specified below in square feet are converted at a rate of 1 square metre = 10.764 square feet and rounded to the nearest whole square foot, which may be slightly different from that shown in square metre.

### 備註 :

- 發展項目內所有座樓之住宅由7樓開始。
- 發展項目不設第4座。
- 發展項目內所有座樓均不設4樓、13樓、14樓、24樓及34樓。
- 第1座及第2座均不設6樓及19樓；第6座、第7座、第9座及第10座均不設20樓及21樓。
- 第3座、第5座、第6座、第7座、第8座、第9座及第10座均不設2樓。
- 住宅物業的實用面積、以及露台、工作平台及陽台(如有)的樓面面積，是按照《一手住宅物業銷售條例》第8條計算得出的。其他指明項目的面積(不計算入實用面積)，是按照《一手住宅物業銷售條例》附表2第2部計算得出的。
- 下述所列之平方呎面積是以1平方米=10.764平方呎換算，並以四捨五入至整數平方呎，平方呎與平方米之數字可能有些微差異。

# AREA OF RESIDENTIAL PROPERTIES IN THE DEVELOPMENT

## 發展項目中的住宅物業的面積

Description of Residential Property 物業的描述			Saleable Area (including balcony, utility platform and verandah, if any) sq. metre (sq.ft.) 實用面積 (包括露台, 工作平台及陽台 (如有)) 平方米(平方呎)	Area of other specified items (Not included in the Saleable Area) sq. metre (sq.ft.) 其他指明項目的面積 (不計算入實用面積) 平方米(平方呎)									
Block Name 大廈名稱	Floor 樓層	Unit 單位		Air- conditioning plant room 空調機房	Bay window 窗台	Cockloft 閣樓	Flat roof 平台	Garden 花園	Parking space 停車位	Roof 天台	Stairhood 梯屋	Terrace 前庭	Yard 庭院
Tower 5 第5座	7/F 7樓	A	108.494 (1168) Balcony 露台 :- Utility Platform 工作平台 :- Verandah 陽台 :-	-	-	-	42.224 (454)	-	-	-	-	-	-
		B	107.338 (1155) Balcony 露台 :- Utility Platform 工作平台 :- Verandah 陽台 :-	-	-	-	52.207 (562)	-	-	-	-	-	-
		C	67.171 (723) Balcony 露台 :- Utility Platform 工作平台 :- Verandah 陽台 :-	-	2.644 (28)	-	37.536 (404)	-	-	-	-	-	-
	8/F-9/F 8樓至9樓	A	108.494 (1168) Balcony 露台 :- Utility Platform 工作平台 :- Verandah 陽台 :-	-	-	-	-	-	-	-	-	-	-
	10/F 10樓	A	106.633 (1148) Balcony 露台 :- Utility Platform 工作平台 :- Verandah 陽台 :-	-	-	-	1.080 (12)	-	-	-	-	-	-
	8/F-10/F 8樓至10樓	B	107.338 (1155) Balcony 露台 :- Utility Platform 工作平台 :- Verandah 陽台 :-	-	-	-	-	-	-	-	-	-	-
	11/F 11樓	B	104.847 (1129) Balcony 露台 :- Utility Platform 工作平台 :- Verandah 陽台 :-	-	-	-	1.585 (17)	-	-	-	-	-	-

### Notes :

- The residential floors start from 7/F in all towers of the Development.
- There is no Tower 4 in the Development.
- There are no 4/F, 13/F, 14/F, 24/F and 34/F in all towers of the Development.
- There are no 6/F and 19/F in Tower 1 and Tower 2 and no 20/F and 21/F in Tower 6, Tower 7, Tower 9 and Tower 10.
- There are no 2/F in Tower 3, Tower 5, Tower 6, Tower 7, Tower 8, Tower 9 and Tower 10.
- The saleable area of the residential property and the floor area of balcony, utility platform and verandah (if any) are calculated in accordance with Section 8 of the Residential Properties (First-hand Sales) Ordinance; and the areas of the other specified items (not included in the saleable area) are calculated in accordance with Part 2 of Schedule 2 of the Residential Properties (First-hand Sales) Ordinance.
- The areas as specified below in square feet are converted at a rate of 1 square metre = 10.764 square feet and rounded to the nearest whole square foot, which may be slightly different from that shown in square metre.

### 備註 :

- 發展項目內所有座樓之住宅由7樓開始。
- 發展項目不設第4座。
- 發展項目內所有座樓均不設4樓、13樓、14樓、24樓及34樓。
- 第1座及第2座均不設6樓及19樓；第6座、第7座、第9座及第10座均不設20樓及21樓。
- 第3座、第5座、第6座、第7座、第8座、第9座及第10座均不設2樓。
- 住宅物業的實用面積、以及露台、工作平台及陽台(如有)的樓面面積，是按照《一手住宅物業銷售條例》第8條計算得出的。其他指明項目的面積(不計算入實用面積)，是按照《一手住宅物業銷售條例》附表2第2部計算得出的。
- 下述所列之平方呎面積是以1平方米=10.764平方呎換算，並以四捨五入至整數平方呎，平方呎與平方米之數字可能有些微差異。

# AREA OF RESIDENTIAL PROPERTIES IN THE DEVELOPMENT

## 發展項目中的住宅物業的面積

Description of Residential Property 物業的描述			Saleable Area (including balcony, utility platform and verandah, if any) sq. metre (sq.ft.) 實用面積 (包括露台, 工作平台及陽台 (如有)) 平方米(平方呎)	Area of other specified items (Not included in the Saleable Area) sq. metre (sq.ft.) 其他指明項目的面積 (不計算入實用面積) 平方米(平方呎)									
Block Name 大廈名稱	Floor 樓層	Unit 單位		Air- conditioning plant room 空調機房	Bay window 窗台	Cockloft 閣樓	Flat roof 平台	Garden 花園	Parking space 停車位	Roof 天台	Stairhood 梯屋	Terrace 前庭	Yard 庭院
Tower 5 第5座	11/F - 37/F 11樓至37樓	A	109.821 (1182) Balcony 露台 : 3.188 (34) Utility Platform 工作平台 : - Verandah 陽台 : -	-	-	-	-	-	-	-	-	-	
	12/F - 37/F 12樓至37樓	B	108.035 (1163) Balcony 露台 : 3.188 (34) Utility Platform 工作平台 : - Verandah 陽台 : -	-	-	-	-	-	-	-	-	-	
	8/F-37/F 8樓至37樓	C	70.994 (764) Balcony 露台 : 2.280 (25) Utility Platform 工作平台 : 1.500 (16) Verandah 陽台 : -	-	2.644 (28)	-	-	-	-	-	-	-	
	38/F 38樓	A	173.594 (1869) Balcony 露台 : 3.704 (40) Utility Platform 工作平台 : - Verandah 陽台 : -	-	-	-	32.441 (349)	-	-	-	-	-	
	38/F - 39/F 38樓至39樓	C	132.834 (1430) Balcony 露台 : - Utility Platform 工作平台 : - Verandah 陽台 : -	-	-	-	11.076 (119)	-	-	5.756 (62)	6.935 (75)	-	
	39/F 39樓	A	178.349 (1920) Balcony 露台 : 3.704 (40) Utility Platform 工作平台 : - Verandah 陽台 : -	-	-	-	-	-	-	12.241 (132)	7.800 (84)	-	

### Notes :

- The residential floors start from 7/F in all towers of the Development.
- There is no Tower 4 in the Development.
- There are no 4/F, 13/F, 14/F, 24/F and 34/F in all towers of the Development.
- There are no 6/F and 19/F in Tower 1 and Tower 2 and no 20/F and 21/F in Tower 6, Tower 7, Tower 9 and Tower 10.
- There are no 2/F in Tower 3, Tower 5, Tower 6, Tower 7, Tower 8, Tower 9 and Tower 10.
- The saleable area of the residential property and the floor area of balcony, utility platform and verandah (if any) are calculated in accordance with Section 8 of the Residential Properties (First-hand Sales) Ordinance; and the areas of the other specified items (not included in the saleable area) are calculated in accordance with Part 2 of Schedule 2 of the Residential Properties (First-hand Sales) Ordinance.
- The areas as specified below in square feet are converted at a rate of 1 square metre = 10.764 square feet and rounded to the nearest whole square foot, which may be slightly different from that shown in square metre.

### 備註 :

- 發展項目內所有座樓之住宅由7樓開始。
- 發展項目不設第4座。
- 發展項目內所有座樓均不設4樓、13樓、14樓、24樓及34樓。
- 第1座及第2座均不設6樓及19樓；第6座、第7座、第9座及第10座均不設20樓及21樓。
- 第3座、第5座、第6座、第7座、第8座、第9座及第10座均不設2樓。
- 住宅物業的實用面積、以及露台、工作平台及陽台(如有)的樓面面積，是按照《一手住宅物業銷售條例》第8條計算得出的。其他指明項目的面積(不計算入實用面積)，是按照《一手住宅物業銷售條例》附表2第2部計算得出的。
- 下述所列之平方呎面積是以1平方米=10.764平方呎換算，並以四捨五入至整數平方呎，平方呎與平方米之數字可能有些微差異。

# AREA OF RESIDENTIAL PROPERTIES IN THE DEVELOPMENT

## 發展項目中的住宅物業的面積

Description of Residential Property 物業的描述			Saleable Area (including balcony, utility platform and verandah, if any) sq. metre (sq.ft.) 實用面積 (包括露台, 工作平台及陽台 (如有)) 平方米(平方呎)	Area of other specified items (Not included in the Saleable Area) sq. metre (sq.ft.) 其他指明項目的面積 (不計算入實用面積) 平方米(平方呎)									
Block Name 大廈名稱	Floor 樓層	Unit 單位		Air- conditioning plant room 空調機房	Bay window 窗台	Cockloft 閣樓	Flat roof 平台	Garden 花園	Parking space 停車位	Roof 天台	Stairhood 梯屋	Terrace 前庭	Yard 庭院
Tower 6 第6座	7/F 7樓	A	109.180 (1175) Balcony 露台 :- Utility Platform 工作平台 :- Verandah 陽台 :-	-	-	-	40.418 (435)	-	-	-	-	-	-
		B	105.949 (1140) Balcony 露台 :- Utility Platform 工作平台 :- Verandah 陽台 :-	-	-	-	56.274 (606)	-	-	-	-	-	-
		C	67.171 (723) Balcony 露台 :- Utility Platform 工作平台 :- Verandah 陽台 :-	-	2.644 (28)	-	37.536 (404)	-	-	-	-	-	-
	8/F-15/F 8樓至15樓	A	109.180 (1175) Balcony 露台 :- Utility Platform 工作平台 :- Verandah 陽台 :-	-	-	-	-	-	-	-	-	-	-
	16/F 16樓	A	107.320 (1155) Balcony 露台 :- Utility Platform 工作平台 :- Verandah 陽台 :-	-	-	-	1.080 (12)	-	-	-	-	-	-
	17/F-19/F, 26/F-37/F 17樓至19樓, 26樓至37樓	A	110.507 (1189) Balcony 露台 : 3.188 (34) Utility Platform 工作平台 :- Verandah 陽台 :-	-	-	-	-	-	-	-	-	-	-

### Notes :

- The residential floors start from 7/F in all towers of the Development.
- There is no Tower 4 in the Development.
- There are no 4/F, 13/F, 14/F, 24/F and 34/F in all towers of the Development.
- There are no 6/F and 19/F in Tower 1 and Tower 2 and no 20/F and 21/F in Tower 6, Tower 7, Tower 9 and Tower 10.
- There are no 2/F in Tower 3, Tower 5, Tower 6, Tower 7, Tower 8, Tower 9 and Tower 10.
- The saleable area of the residential property and the floor area of balcony, utility platform and verandah (if any) are calculated in accordance with Section 8 of the Residential Properties (First-hand Sales) Ordinance; and the areas of the other specified items (not included in the saleable area) are calculated in accordance with Part 2 of Schedule 2 of the Residential Properties (First-hand Sales) Ordinance.
- The areas as specified below in square feet are converted at a rate of 1 square metre = 10.764 square feet and rounded to the nearest whole square foot, which may be slightly different from that shown in square metre.

### 備註 :

- 發展項目內所有座樓之住宅由7樓開始。
- 發展項目不設第4座。
- 發展項目內所有座樓均不設4樓、13樓、14樓、24樓及34樓。
- 第1座及第2座均不設6樓及19樓；第6座、第7座、第9座及第10座均不設20樓及21樓。
- 第3座、第5座、第6座、第7座、第8座、第9座及第10座均不設2樓。
- 住宅物業的實用面積、以及露台、工作平台及陽台(如有)的樓面面積，是按照《一手住宅物業銷售條例》第8條計算得出的。其他指明項目的面積(不計算入實用面積)，是按照《一手住宅物業銷售條例》附表2第2部計算得出的。
- 下述所列之平方呎面積是以1平方米=10.764平方呎換算，並以四捨五入至整數平方呎，平方呎與平方米之數字可能有些微差異。

# AREA OF RESIDENTIAL PROPERTIES IN THE DEVELOPMENT

## 發展項目中的住宅物業的面積

Description of Residential Property 物業的描述			Saleable Area (including balcony, utility platform and verandah, if any) sq. metre (sq.ft.) 實用面積 (包括露台, 工作平台及陽台 (如有)) 平方米(平方呎)	Area of other specified items (Not included in the Saleable Area) sq. metre (sq.ft.) 其他指明項目的面積 (不計算入實用面積) 平方米(平方呎)									
Block Name 大廈名稱	Floor 樓層	Unit 單位		Air- conditioning plant room 空調機房	Bay window 窗台	Cockloft 閣樓	Flat roof 平台	Garden 花園	Parking space 停車位	Roof 天台	Stairhood 梯屋	Terrace 前庭	Yard 庭院
Tower 6 第6座	8/F-19/F, 26/F-37/F 8樓至19樓, 26樓至37樓	B	109.113 (1174) Balcony 露台 : 3.188 (34) Utility Platform 工作平台 : - Verandah 陽台 : -	-	-	-	-	-	-	-	-	-	
		C	70.994 (764) Balcony 露台 : 2.280 (25) Utility Platform 工作平台 : 1.500 (16) Verandah 陽台 : -	-	2.644 (28)	-	-	-	-	-	-	-	
	22/F-25/F 22樓至25樓	A	111.584 (1201) Balcony 露台 : 3.188 (34) Utility Platform 工作平台 : - Verandah 陽台 : -	-	-	-	-	-	-	-	-	-	-
		C	70.994 (764) Balcony 露台 : 2.280 (25) Utility Platform 工作平台 : 1.500 (16) Verandah 陽台 : -	-	2.644 (28)	-	-	-	-	-	-	-	-
	38/F 38樓	A	169.620 (1826) Balcony 露台 : 3.704 (40) Utility Platform 工作平台 : - Verandah 陽台 : -	-	-	-	35.280 (380)	-	-	-	-	-	
	38/F - 39/F 38樓至39樓	C	132.834 (1430) Balcony 露台 : - Utility Platform 工作平台 : - Verandah 陽台 : -	-	-	-	11.076 (119)	-	-	24.896 (268)	6.935 (75)	-	-
	39/F 39樓	A	170.152 (1832) Balcony 露台 : - Utility Platform 工作平台 : - Verandah 陽台 : -	-	-	-	-	-	-	131.784 (1419)	7.800 (84)	-	-

### Notes :

- The residential floors start from 7/F in all towers of the Development.
- There is no Tower 4 in the Development.
- There are no 4/F, 13/F, 14/F, 24/F and 34/F in all towers of the Development.
- There are no 6/F and 19/F in Tower 1 and Tower 2 and no 20/F and 21/F in Tower 6, Tower 7, Tower 9 and Tower 10.
- There are no 2/F in Tower 3, Tower 5, Tower 6, Tower 7, Tower 8, Tower 9 and Tower 10.
- The saleable area of the residential property and the floor area of balcony, utility platform and verandah (if any) are calculated in accordance with Section 8 of the Residential Properties (First-hand Sales) Ordinance; and the areas of the other specified items (not included in the saleable area) are calculated in accordance with Part 2 of Schedule 2 of the Residential Properties (First-hand Sales) Ordinance.
- The areas as specified below in square feet are converted at a rate of 1 square metre = 10.764 square feet and rounded to the nearest whole square foot, which may be slightly different from that shown in square metre.

### 備註 :

- 發展項目內所有座樓之住宅由7樓開始。
- 發展項目不設第4座。
- 發展項目內所有座樓均不設4樓、13樓、14樓、24樓及34樓。
- 第1座及第2座均不設6樓及19樓；第6座、第7座、第9座及第10座均不設20樓及21樓。
- 第3座、第5座、第6座、第7座、第8座、第9座及第10座均不設2樓。
- 住宅物業的實用面積、以及露台、工作平台及陽台(如有)的樓面面積，是按照《一手住宅物業銷售條例》第8條計算得出的。其他指明項目的面積(不計算入實用面積)，是按照《一手住宅物業銷售條例》附表2第2部計算得出的。
- 下述所列之平方呎面積是以1平方米=10.764平方呎換算，並以四捨五入至整數平方呎，平方呎與平方米之數字可能有些微差異。



# AREA OF RESIDENTIAL PROPERTIES IN THE DEVELOPMENT

## 發展項目中的住宅物業的面積

Description of Residential Property 物業的描述			Saleable Area (including balcony, utility platform and verandah, if any) sq. metre (sq.ft.) 實用面積 (包括露台, 工作平台及陽台 (如有)) 平方米(平方呎)	Area of other specified items (Not included in the Saleable Area) sq. metre (sq.ft.) 其他指明項目的面積 (不計算入實用面積) 平方米(平方呎)									
Block Name 大廈名稱	Floor 樓層	Unit 單位		Air- conditioning plant room 空調機房	Bay window 窗台	Cockloft 閣樓	Flat roof 平台	Garden 花園	Parking space 停車位	Roof 天台	Stairhood 梯屋	Terrace 前庭	Yard 庭院
Tower 7 第7座	7/F 7樓	A	109.390 (1177) Balcony 露台 :- Utility Platform 工作平台 :- Verandah 陽台 :-	-	-	-	49.739 (535)	-	-	-	-	-	-
		B	124.686 (1342) Balcony 露台 :- Utility Platform 工作平台 :- Verandah 陽台 :-	-	0.686 (7)	-	36.718 (395)	-	-	-	-	-	-
		C	68.979 (742) Balcony 露台 :- Utility Platform 工作平台 :- Verandah 陽台 :-	-	2.644 (28)	-	36.204 (390)	-	-	-	-	-	-
	8/F-9/F 8樓至9樓	A	109.390 (1177) Balcony 露台 :- Utility Platform 工作平台 :- Verandah 陽台 :-	-	-	-	-	-	-	-	-	-	-
	10/F 10樓	A	106.900 (1151) Balcony 露台 :- Utility Platform 工作平台 :- Verandah 陽台 :-	-	-	-	1.585 (17)	-	-	-	-	-	-
	11/F-19/F, 26/F-37/F 11樓至19樓, 26樓至37樓	A	110.088 (1185) Balcony 露台 : 3.188 (34) Utility Platform 工作平台 :- Verandah 陽台 :-	-	-	-	-	-	-	-	-	-	-

### Notes :

- The residential floors start from 7/F in all towers of the Development.
- There is no Tower 4 in the Development.
- There are no 4/F, 13/F, 14/F, 24/F and 34/F in all towers of the Development.
- There are no 6/F and 19/F in Tower 1 and Tower 2 and no 20/F and 21/F in Tower 6, Tower 7, Tower 9 and Tower 10.
- There are no 2/F in Tower 3, Tower 5, Tower 6, Tower 7, Tower 8, Tower 9 and Tower 10.
- The saleable area of the residential property and the floor area of balcony, utility platform and verandah (if any) are calculated in accordance with Section 8 of the Residential Properties (First-hand Sales) Ordinance; and the areas of the other specified items (not included in the saleable area) are calculated in accordance with Part 2 of Schedule 2 of the Residential Properties (First-hand Sales) Ordinance.
- The areas as specified below in square feet are converted at a rate of 1 square metre = 10.764 square feet and rounded to the nearest whole square foot, which may be slightly different from that shown in square metre.

### 備註 :

- 發展項目內所有座樓之住宅由7樓開始。
- 發展項目不設第4座。
- 發展項目內所有座樓均不設4樓、13樓、14樓、24樓及34樓。
- 第1座及第2座均不設6樓及19樓；第6座、第7座、第9座及第10座均不設20樓及21樓。
- 第3座、第5座、第6座、第7座、第8座、第9座及第10座均不設2樓。
- 住宅物業的實用面積、以及露台、工作平台及陽台(如有)的樓面面積，是按照《一手住宅物業銷售條例》第8條計算得出的。其他指明項目的面積(不計算入實用面積)，是按照《一手住宅物業銷售條例》附表2第2部計算得出的。
- 下述所列之平方呎面積是以1平方米=10.764平方呎換算，並以四捨五入至整數平方呎，平方呎與平方米之數字可能有些微差異。

# AREA OF RESIDENTIAL PROPERTIES IN THE DEVELOPMENT

## 發展項目中的住宅物業的面積

Description of Residential Property 物業的描述			Saleable Area (including balcony, utility platform and verandah, if any) sq. metre (sq.ft.) 實用面積 (包括露台, 工作平台及陽台 (如有)) 平方米(平方呎)	Area of other specified items (Not included in the Saleable Area) sq. metre (sq.ft.) 其他指明項目的面積 (不計算入實用面積) 平方米(平方呎)									
Block Name 大廈名稱	Floor 樓層	Unit 單位		Air- conditioning plant room 空調機房	Bay window 窗台	Cockloft 閣樓	Flat roof 平台	Garden 花園	Parking space 停車位	Roof 天台	Stairhood 梯屋	Terrace 前庭	Yard 庭院
Tower 7 第7座	8/F-19/F, 26/F-37/F 8樓至19樓, 26樓至37樓	B	127.936 (1377) Balcony 露台 : 3.257 (35) Utility Platform 工作平台 : - Verandah 陽台 : -	-	0.686 (7)	-	-	-	-	-	-	-	
		C	72.788 (783) Balcony 露台 : 2.348 (25) Utility Platform 工作平台 : 1.500 (16) Verandah 陽台 : -	-	2.644 (28)	-	-	-	-	-	-	-	
	22/F-25/F 22樓至25樓	B	129.012 (1389) Balcony 露台 : 3.257 (35) Utility Platform 工作平台 : - Verandah 陽台 : -	-	0.686 (7)	-	-	-	-	-	-	-	
		C	72.788 (783) Balcony 露台 : 2.348 (25) Utility Platform 工作平台 : 1.500 (16) Verandah 陽台 : -	-	2.644 (28)	-	-	-	-	-	-	-	
	38/F 38樓	A	185.043 (1992) Balcony 露台 : 3.979 (43) Utility Platform 工作平台 : - Verandah 陽台 : -	-	-	-	39.178 (422)	-	-	-	-	-	
	38/F-39/F 38樓至39樓	C	144.085 (1551) Balcony 露台 : 4.617 (50) Utility Platform 工作平台 : - Verandah 陽台 : -	-	-	-	-	-	-	35.737 (385)	5.985 (64)	-	
	39/F 39樓	A	185.189 (1993) Balcony 露台 : - Utility Platform 工作平台 : - Verandah 陽台 : -	-	-	-	-	-	-	144.493 (1555)	7.800 (84)	-	

### Notes :

- The residential floors start from 7/F in all towers of the Development.
- There is no Tower 4 in the Development.
- There are no 4/F, 13/F, 14/F, 24/F and 34/F in all towers of the Development.
- There are no 6/F and 19/F in Tower 1 and Tower 2 and no 20/F and 21/F in Tower 6, Tower 7, Tower 9 and Tower 10.
- There are no 2/F in Tower 3, Tower 5, Tower 6, Tower 7, Tower 8, Tower 9 and Tower 10.
- The saleable area of the residential property and the floor area of balcony, utility platform and verandah (if any) are calculated in accordance with Section 8 of the Residential Properties (First-hand Sales) Ordinance; and the areas of the other specified items (not included in the saleable area) are calculated in accordance with Part 2 of Schedule 2 of the Residential Properties (First-hand Sales) Ordinance.
- The areas as specified below in square feet are converted at a rate of 1 square metre = 10.764 square feet and rounded to the nearest whole square foot, which may be slightly different from that shown in square metre.

### 備註 :

- 發展項目內所有座樓之住宅由7樓開始。
- 發展項目不設第4座。
- 發展項目內所有座樓均不設4樓、13樓、14樓、24樓及34樓。
- 第1座及第2座均不設6樓及19樓；第6座、第7座、第9座及第10座均不設20樓及21樓。
- 第3座、第5座、第6座、第7座、第8座、第9座及第10座均不設2樓。
- 住宅物業的實用面積、以及露台、工作平台及陽台(如有)的樓面面積，是按照《一手住宅物業銷售條例》第8條計算得出的。其他指明項目的面積(不計算入實用面積)，是按照《一手住宅物業銷售條例》附表2第2部計算得出的。
- 下述所列之平方呎面積是以1平方米=10.764平方呎換算，並以四捨五入至整數平方呎，平方呎與平方米之數字可能有些微差異。

# AREA OF RESIDENTIAL PROPERTIES IN THE DEVELOPMENT

## 發展項目中的住宅物業的面積

Description of Residential Property 物業的描述			Saleable Area (including balcony, utility platform and verandah, if any) sq. metre (sq.ft.) 實用面積 (包括露台, 工作平台及陽台 (如有)) 平方米(平方呎)	Area of other specified items (Not included in the Saleable Area) sq. metre (sq.ft.) 其他指明項目的面積 (不計算入實用面積) 平方米(平方呎)									
Block Name 大廈名稱	Floor 樓層	Unit 單位		Air- conditioning plant room 空調機房	Bay window 窗台	Cockloft 閣樓	Flat roof 平台	Garden 花園	Parking space 停車位	Roof 天台	Stairhood 梯屋	Terrace 前庭	Yard 庭院
Tower 8 第8座	7/F 7樓	A	95.083 (1023) Balcony 露台 :- Utility Platform 工作平台 :- Verandah 陽台 :-	-	-	-	43.307 (466)	-	-	-	-	-	-
		B	94.847 (1021) Balcony 露台 :- Utility Platform 工作平台 :- Verandah 陽台 :-	-	-	-	45.456 (489)	-	-	-	-	-	-
		C	51.808 (558) Balcony 露台 :- Utility Platform 工作平台 :- Verandah 陽台 :-	-	1.969 (21)	-	20.657 (222)	-	-	-	-	-	-
		D	51.808 (558) Balcony 露台 :- Utility Platform 工作平台 :- Verandah 陽台 :-	-	1.969 (21)	-	20.104 (216)	-	-	-	-	-	-
	8/F-36/F 8樓至36樓	A	97.942 (1054) Balcony 露台 : 2.859 (31) Utility Platform 工作平台 :- Verandah 陽台 :-	-	-	-	-	-	-	-	-	-	-
		B	97.706 (1052) Balcony 露台 : 2.859 (31) Utility Platform 工作平台 :- Verandah 陽台 :-	-	-	-	-	-	-	-	-	-	-
		C	55.377 (596) Balcony 露台 : 2.078 (22) Utility Platform 工作平台 : 1.491 (16) Verandah 陽台 :-	-	1.969 (21)	-	-	-	-	-	-	-	-

### Notes :

- The residential floors start from 7/F in all towers of the Development.
- There is no Tower 4 in the Development.
- There are no 4/F, 13/F, 14/F, 24/F and 34/F in all towers of the Development.
- There are no 6/F and 19/F in Tower 1 and Tower 2 and no 20/F and 21/F in Tower 6, Tower 7, Tower 9 and Tower 10.
- There are no 2/F in Tower 3, Tower 5, Tower 6, Tower 7, Tower 8, Tower 9 and Tower 10.
- The saleable area of the residential property and the floor area of balcony, utility platform and verandah (if any) are calculated in accordance with Section 8 of the Residential Properties (First-hand Sales) Ordinance; and the areas of the other specified items (not included in the saleable area) are calculated in accordance with Part 2 of Schedule 2 of the Residential Properties (First-hand Sales) Ordinance.
- The areas as specified below in square feet are converted at a rate of 1 square metre = 10.764 square feet and rounded to the nearest whole square foot, which may be slightly different from that shown in square metre.

### 備註 :

- 發展項目內所有座樓之住宅由7樓開始。
- 發展項目不設第4座。
- 發展項目內所有座樓均不設4樓、13樓、14樓、24樓及34樓。
- 第1座及第2座均不設6樓及19樓；第6座、第7座、第9座及第10座均不設20樓及21樓。
- 第3座、第5座、第6座、第7座、第8座、第9座及第10座均不設2樓。
- 住宅物業的實用面積、以及露台、工作平台及陽台(如有)的樓面面積，是按照《一手住宅物業銷售條例》第8條計算得出的。其他指明項目的面積(不計算入實用面積)，是按照《一手住宅物業銷售條例》附表2第2部計算得出的。
- 下述所列之平方呎面積是以1平方米=10.764平方呎換算，並以四捨五入至整數平方呎，平方呎與平方米之數字可能有些微差異。

# AREA OF RESIDENTIAL PROPERTIES IN THE DEVELOPMENT

## 發展項目中的住宅物業的面積

Description of Residential Property 物業的描述			Saleable Area (including balcony, utility platform and verandah, if any) sq. metre (sq.ft.) 實用面積 (包括露台, 工作平台及陽台 (如有)) 平方米(平方呎)	Area of other specified items (Not included in the Saleable Area) sq. metre (sq.ft.) 其他指明項目的面積 (不計算入實用面積) 平方米(平方呎)								
Block Name 大廈名稱	Floor 樓層	Unit 單位		Air- conditioning plant room 空調機房	Bay window 窗台	Cockloft 閣樓	Flat roof 平台	Garden 花園	Parking space 停車位	Roof 天台	Stairhood 梯屋	Terrace 前庭
Tower 8 第8座	8/F-36/F 8樓至36樓	D	55.377 (596) Balcony 露台 : 2.078 (22) Utility Platform 工作平台 : 1.491 (16) Verandah 陽台 : -	-	1.969 (21)	-	-	-	-	-	-	-
		A	146.230 (1574) Balcony 露台 : 2.859 (31) Utility Platform 工作平台 : - Verandah 陽台 : -	-	-	-	29.122 (313)	-	-	-	-	-
	37/F 37樓	C	55.377 (596) Balcony 露台 : 2.078 (22) Utility Platform 工作平台 : 1.491 (16) Verandah 陽台 : -	-	1.969 (21)	-	-	-	-	-	-	-
		D	55.377 (596) Balcony 露台 : 2.078 (22) Utility Platform 工作平台 : 1.491 (16) Verandah 陽台 : -	-	1.969 (21)	-	-	-	-	-	-	-
		A	151.037 (1626) Balcony 露台 : 2.859 (31) Utility Platform 工作平台 : - Verandah 陽台 : -	-	-	-	-	-	38.581 (415)	7.800 (84)	-	-
	38/F 38樓	C	55.377 (596) Balcony 露台 : 2.078 (22) Utility Platform 工作平台 : 1.491 (16) Verandah 陽台 : -	-	1.969 (21)	-	-	-	-	-	-	-
		D	55.377 (596) Balcony 露台 : 2.078 (22) Utility Platform 工作平台 : 1.491 (16) Verandah 陽台 : -	-	1.969 (21)	-	-	-	-	-	-	-

### Notes :

- The residential floors start from 7/F in all towers of the Development.
- There is no Tower 4 in the Development.
- There are no 4/F, 13/F, 14/F, 24/F and 34/F in all towers of the Development.
- There are no 6/F and 19/F in Tower 1 and Tower 2 and no 20/F and 21/F in Tower 6, Tower 7, Tower 9 and Tower 10.
- There are no 2/F in Tower 3, Tower 5, Tower 6, Tower 7, Tower 8, Tower 9 and Tower 10.
- The saleable area of the residential property and the floor area of balcony, utility platform and verandah (if any) are calculated in accordance with Section 8 of the Residential Properties (First-hand Sales) Ordinance; and the areas of the other specified items (not included in the saleable area) are calculated in accordance with Part 2 of Schedule 2 of the Residential Properties (First-hand Sales) Ordinance.
- The areas as specified below in square feet are converted at a rate of 1 square metre = 10.764 square feet and rounded to the nearest whole square foot, which may be slightly different from that shown in square metre.

### 備註 :

- 發展項目內所有座樓之住宅由7樓開始。
- 發展項目不設第4座。
- 發展項目內所有座樓均不設4樓、13樓、14樓、24樓及34樓。
- 第1座及第2座均不設6樓及19樓；第6座、第7座、第9座及第10座均不設20樓及21樓。
- 第3座、第5座、第6座、第7座、第8座、第9座及第10座均不設2樓。
- 住宅物業的實用面積、以及露台、工作平台及陽台(如有)的樓面面積，是按照《一手住宅物業銷售條例》第8條計算得出的。其他指明項目的面積(不計算入實用面積)，是按照《一手住宅物業銷售條例》附表2第2部計算得出的。
- 下述所列之平方呎面積是以1平方米=10.764平方呎換算，並以四捨五入至整數平方呎，平方呎與平方米之數字可能有些微差異。

# AREA OF RESIDENTIAL PROPERTIES IN THE DEVELOPMENT

## 發展項目中的住宅物業的面積

Description of Residential Property 物業的描述			Saleable Area (including balcony, utility platform and verandah, if any) sq. metre (sq.ft.) 實用面積 (包括露台, 工作平台及陽台 (如有)) 平方米(平方呎)	Area of other specified items (Not included in the Saleable Area) sq. metre (sq.ft.) 其他指明項目的面積 (不計算入實用面積) 平方米(平方呎)									
Block Name 大廈名稱	Floor 樓層	Unit 單位		Air- conditioning plant room 空調機房	Bay window 窗台	Cockloft 閣樓	Flat roof 平台	Garden 花園	Parking space 停車位	Roof 天台	Stairhood 梯屋	Terrace 前庭	Yard 庭院
Tower 9 第9座	7/F 7樓	A	94.704 (1019) Balcony 露台 :- Utility Platform 工作平台 :- Verandah 陽台 :-	-	-	-	36.239 (390)	-	-	-	-	-	-
		B	95.694 (1030) Balcony 露台 :- Utility Platform 工作平台 :- Verandah 陽台 :-	-	-	-	80.008 (861)	-	-	-	-	-	-
		C	51.808 (558) Balcony 露台 :- Utility Platform 工作平台 :- Verandah 陽台 :-	-	1.969 (21)	-	21.277 (229)	-	-	-	-	-	-
		D	39.498 (425) Balcony 露台 :- Utility Platform 工作平台 :- Verandah 陽台 :-	-	0.979 (11)	-	24.108 (259)	-	-	-	-	-	-
	8/F-19/F, 26/F-35/F 8樓至19樓, 26樓至35樓	A	97.563 (1050) Balcony 露台 : 2.859 (31) Utility Platform 工作平台 :- Verandah 陽台 :-	-	-	-	-	-	-	-	-	-	-
		B	98.553 (1061) Balcony 露台 : 2.859 (31) Utility Platform 工作平台 :- Verandah 陽台 :-	-	-	-	-	-	-	-	-	-	-
		C	55.377 (596) Balcony 露台 : 2.078 (22) Utility Platform 工作平台 : 1.491 (16) Verandah 陽台 :-	-	1.969 (21)	-	-	-	-	-	-	-	-

### Notes :

- The residential floors start from 7/F in all towers of the Development.
- There is no Tower 4 in the Development.
- There are no 4/F, 13/F, 14/F, 24/F and 34/F in all towers of the Development.
- There are no 6/F and 19/F in Tower 1 and Tower 2 and no 20/F and 21/F in Tower 6, Tower 7, Tower 9 and Tower 10.
- There are no 2/F in Tower 3, Tower 5, Tower 6, Tower 7, Tower 8, Tower 9 and Tower 10.
- The saleable area of the residential property and the floor area of balcony, utility platform and verandah (if any) are calculated in accordance with Section 8 of the Residential Properties (First-hand Sales) Ordinance; and the areas of the other specified items (not included in the saleable area) are calculated in accordance with Part 2 of Schedule 2 of the Residential Properties (First-hand Sales) Ordinance.
- The areas as specified below in square feet are converted at a rate of 1 square metre = 10.764 square feet and rounded to the nearest whole square foot, which may be slightly different from that shown in square metre.

### 備註 :

- 發展項目內所有座樓之住宅由7樓開始。
- 發展項目不設第4座。
- 發展項目內所有座樓均不設4樓、13樓、14樓、24樓及34樓。
- 第1座及第2座均不設6樓及19樓；第6座、第7座、第9座及第10座均不設20樓及21樓。
- 第3座、第5座、第6座、第7座、第8座、第9座及第10座均不設2樓。
- 住宅物業的實用面積、以及露台、工作平台及陽台(如有)的樓面面積，是按照《一手住宅物業銷售條例》第8條計算得出的。其他指明項目的面積(不計算入實用面積)，是按照《一手住宅物業銷售條例》附表2第2部計算得出的。
- 下述所列之平方呎面積是以1平方米=10.764平方呎換算，並以四捨五入至整數平方呎，平方呎與平方米之數字可能有些微差異。

# AREA OF RESIDENTIAL PROPERTIES IN THE DEVELOPMENT

## 發展項目中的住宅物業的面積

Description of Residential Property 物業的描述			Saleable Area (including balcony, utility platform and verandah, if any) sq. metre (sq.ft.) 實用面積 (包括露台, 工作平台及陽台 (如有)) 平方米(平方呎)	Area of other specified items (Not included in the Saleable Area) sq. metre (sq.ft.) 其他指明項目的面積 (不計算入實用面積) 平方米(平方呎)									
Block Name 大廈名稱	Floor 樓層	Unit 單位		Air- conditioning plant room 空調機房	Bay window 窗台	Cockloft 閣樓	Flat roof 平台	Garden 花園	Parking space 停車位	Roof 天台	Stairhood 梯屋	Terrace 前庭	Yard 庭院
Tower 9 第9座	8/F-19/F, 26/F-35/F 8樓至19樓, 26樓至35樓	D	42.999 (463) Balcony 露台 : 2.010 (22) Utility Platform 工作平台 : 1.491 (16) Verandah 陽台 : -	-	0.979 (11)	-	-	-	-	-	-	-	
		A	98.617 (1062) Balcony 露台 : 2.859 (31) Utility Platform 工作平台 : - Verandah 陽台 : -	-	-	-	-	-	-	-	-	-	
	22/F-23/F & 25/F 22樓至23樓及 25樓	C	55.377 (596) Balcony 露台 : 2.078 (22) Utility Platform 工作平台 : 1.491 (16) Verandah 陽台 : -	-	1.969 (21)	-	-	-	-	-	-	-	
		D	42.999 (463) Balcony 露台 : 2.010 (22) Utility Platform 工作平台 : 1.491 (16) Verandah 陽台 : -	-	0.979 (11)	-	-	-	-	-	-	-	
		A	146.375 (1576) Balcony 露台 : 2.859 (31) Utility Platform 工作平台 : - Verandah 陽台 : -	-	-	-	29.232 (315)	-	-	-	-	-	
	36/F 36樓	C	55.377 (596) Balcony 露台 : 2.078 (22) Utility Platform 工作平台 : 1.491 (16) Verandah 陽台 : -	-	1.969 (21)	-	-	-	-	-	-	-	
		D	42.999 (463) Balcony 露台 : 2.010 (22) Utility Platform 工作平台 : 1.491 (16) Verandah 陽台 : -	-	0.979 (11)	-	-	-	-	-	-	-	

### Notes :

- The residential floors start from 7/F in all towers of the Development.
- There is no Tower 4 in the Development.
- There are no 4/F, 13/F, 14/F, 24/F and 34/F in all towers of the Development.
- There are no 6/F and 19/F in Tower 1 and Tower 2 and no 20/F and 21/F in Tower 6, Tower 7, Tower 9 and Tower 10.
- There are no 2/F in Tower 3, Tower 5, Tower 6, Tower 7, Tower 8, Tower 9 and Tower 10.
- The saleable area of the residential property and the floor area of balcony, utility platform and verandah (if any) are calculated in accordance with Section 8 of the Residential Properties (First-hand Sales) Ordinance; and the areas of the other specified items (not included in the saleable area) are calculated in accordance with Part 2 of Schedule 2 of the Residential Properties (First-hand Sales) Ordinance.
- The areas as specified below in square feet are converted at a rate of 1 square metre = 10.764 square feet and rounded to the nearest whole square foot, which may be slightly different from that shown in square metre.

### 備註 :

- 發展項目內所有座樓之住宅由7樓開始。
- 發展項目不設第4座。
- 發展項目內所有座樓均不設4樓、13樓、14樓、24樓及34樓。
- 第1座及第2座均不設6樓及19樓；第6座、第7座、第9座及第10座均不設20樓及21樓。
- 第3座、第5座、第6座、第7座、第8座、第9座及第10座均不設2樓。
- 住宅物業的實用面積、以及露台、工作平台及陽台(如有)的樓面面積，是按照《一手住宅物業銷售條例》第8條計算得出的。其他指明項目的面積(不計算入實用面積)，是按照《一手住宅物業銷售條例》附表2第2部計算得出的。
- 下述所列之平方呎面積是以1平方米=10.764平方呎換算，並以四捨五入至整數平方呎，平方呎與平方米之數字可能有些微差異。

# AREA OF RESIDENTIAL PROPERTIES IN THE DEVELOPMENT

## 發展項目中的住宅物業的面積

Description of Residential Property 物業的描述			Saleable Area (including balcony, utility platform and verandah, if any) sq. metre (sq.ft.) 實用面積 (包括露台, 工作平台及陽台 (如有)) 平方米(平方呎)	Area of other specified items (Not included in the Saleable Area) sq. metre (sq.ft.) 其他指明項目的面積 (不計算入實用面積) 平方米(平方呎)									
Block Name 大廈名稱	Floor 樓層	Unit 單位		Air- conditioning plant room 空調機房	Bay window 窗台	Cockloft 閣樓	Flat roof 平台	Garden 花園	Parking space 停車位	Roof 天台	Stairhood 梯屋	Terrace 前庭	Yard 庭院
Tower 9 第9座	37/F 37樓	A	151.186 (1627) Balcony 露台 : 2.859 (31) Utility Platform 工作平台 : - Verandah 陽台 : -	-	-	-	-	-	114.424 (1232)	7.800 (84)	-	-	
		C	55.377 (596) Balcony 露台 : 2.078 (22) Utility Platform 工作平台 : 1.491 (16) Verandah 陽台 : -	-	1.969 (21)	-	-	-	20.366 (219)	-	-	-	
		D	42.999 (463) Balcony 露台 : 2.010 (22) Utility Platform 工作平台 : 1.491 (16) Verandah 陽台 : -	-	0.979 (11)	-	-	-	23.218 (250)	-	-	-	
Tower 10 第10座	7/F 7樓	A	96.596 (1040) Balcony 露台 : - Utility Platform 工作平台 : - Verandah 陽台 : -	-	-	-	81.573 (878)	-	-	-	-	-	
		B	96.546 (1039) Balcony 露台 : - Utility Platform 工作平台 : - Verandah 陽台 : -	-	-	-	87.761 (945)	-	-	-	-	-	
		C	42.892 (462) Balcony 露台 : 2.010 (22) Utility Platform 工作平台 : 1.491 (16) Verandah 陽台 : -	-	0.979 (11)	-	3.113 (34)	-	-	-	-	-	
		D	42.999 (463) Balcony 露台 : 2.010 (22) Utility Platform 工作平台 : 1.491 (16) Verandah 陽台 : -	-	0.979 (11)	-	1.744 (19)	-	-	-	-	-	

### Notes :

- The residential floors start from 7/F in all towers of the Development.
- There is no Tower 4 in the Development.
- There are no 4/F, 13/F, 14/F, 24/F and 34/F in all towers of the Development.
- There are no 6/F and 19/F in Tower 1 and Tower 2 and no 20/F and 21/F in Tower 6, Tower 7, Tower 9 and Tower 10.
- There are no 2/F in Tower 3, Tower 5, Tower 6, Tower 7, Tower 8, Tower 9 and Tower 10.
- The saleable area of the residential property and the floor area of balcony, utility platform and verandah (if any) are calculated in accordance with Section 8 of the Residential Properties (First-hand Sales) Ordinance; and the areas of the other specified items (not included in the saleable area) are calculated in accordance with Part 2 of Schedule 2 of the Residential Properties (First-hand Sales) Ordinance.
- The areas as specified below in square feet are converted at a rate of 1 square metre = 10.764 square feet and rounded to the nearest whole square foot, which may be slightly different from that shown in square metre.

### 備註 :

- 發展項目內所有座樓之住宅由7樓開始。
- 發展項目不設第4座。
- 發展項目內所有座樓均不設4樓、13樓、14樓、24樓及34樓。
- 第1座及第2座均不設6樓及19樓；第6座、第7座、第9座及第10座均不設20樓及21樓。
- 第3座、第5座、第6座、第7座、第8座、第9座及第10座均不設2樓。
- 住宅物業的實用面積、以及露台、工作平台及陽台(如有)的樓面面積，是按照《一手住宅物業銷售條例》第8條計算得出的。其他指明項目的面積(不計算入實用面積)，是按照《一手住宅物業銷售條例》附表2第2部計算得出的。
- 下述所列之平方呎面積是以1平方米=10.764平方呎換算，並以四捨五入至整數平方呎，平方呎與平方米之數字可能有些微差異。

# AREA OF RESIDENTIAL PROPERTIES IN THE DEVELOPMENT

## 發展項目中的住宅物業的面積

Description of Residential Property 物業的描述			Saleable Area (including balcony, utility platform and verandah, if any) sq. metre (sq.ft.) 實用面積 (包括露台, 工作平台及陽台 (如有)) 平方米(平方呎)	Area of other specified items (Not included in the Saleable Area) sq. metre (sq.ft.) 其他指明項目的面積 (不計算入實用面積) 平方米(平方呎)									
Block Name 大廈名稱	Floor 樓層	Unit 單位		Air- conditioning plant room 空調機房	Bay window 窗台	Cockloft 閣樓	Flat roof 平台	Garden 花園	Parking space 停車位	Roof 天台	Stairhood 梯屋	Terrace 前庭	Yard 庭院
Tower 10 第10座	8/F-12/F 8樓至12樓	B	96.546 (1039) Balcony 露台 : - Utility Platform 工作平台 : - Verandah 陽台 : -	-	-	-	-	-	-	-	-	-	
	15/F 15樓	B	95.024 (1023) Balcony 露台 : - Utility Platform 工作平台 : - Verandah 陽台 : -	-	-	-	0.812 (9)	-	-	-	-	-	
	16/F - 19/F, 26/F-35/F 16樓至19樓, 26樓至35樓	B	97.953 (1054) Balcony 露台 : 2.859 (31) Utility Platform 工作平台 : - Verandah 陽台 : -	-	-	-	-	-	-	-	-	-	
	8/F-19/F, 26/F-35/F 8樓至19樓, 26樓至35樓	A	99.471 (1071) Balcony 露台 : 2.859 (31) Utility Platform 工作平台 : - Verandah 陽台 : -	-	-	-	-	-	-	-	-	-	-
		C	42.892 (462) Balcony 露台 : 2.010 (22) Utility Platform 工作平台 : 1.491 (16) Verandah 陽台 : -	-	0.979 (11)	-	-	-	-	-	-	-	-
		D	42.999 (463) Balcony 露台 : 2.010 (22) Utility Platform 工作平台 : 1.491 (16) Verandah 陽台 : -	-	0.979 (11)	-	-	-	-	-	-	-	-
22/F-25/F 22樓至25樓	B	98.925 (1065) Balcony 露台 : 2.859 (31) Utility Platform 工作平台 : - Verandah 陽台 : -	-	-	-	-	-	-	-	-	-		

### Notes :

- The residential floors start from 7/F in all towers of the Development.
- There is no Tower 4 in the Development.
- There are no 4/F, 13/F, 14/F, 24/F and 34/F in all towers of the Development.
- There are no 6/F and 19/F in Tower 1 and Tower 2 and no 20/F and 21/F in Tower 6, Tower 7, Tower 9 and Tower 10.
- There are no 2/F in Tower 3, Tower 5, Tower 6, Tower 7, Tower 8, Tower 9 and Tower 10.
- The saleable area of the residential property and the floor area of balcony, utility platform and verandah (if any) are calculated in accordance with Section 8 of the Residential Properties (First-hand Sales) Ordinance; and the areas of the other specified items (not included in the saleable area) are calculated in accordance with Part 2 of Schedule 2 of the Residential Properties (First-hand Sales) Ordinance.
- The areas as specified below in square feet are converted at a rate of 1 square metre = 10.764 square feet and rounded to the nearest whole square foot, which may be slightly different from that shown in square metre.

### 備註 :

- 發展項目內所有座樓之住宅由7樓開始。
- 發展項目不設第4座。
- 發展項目內所有座樓均不設4樓、13樓、14樓、24樓及34樓。
- 第1座及第2座均不設6樓及19樓；第6座、第7座、第9座及第10座均不設20樓及21樓。
- 第3座、第5座、第6座、第7座、第8座、第9座及第10座均不設2樓。
- 住宅物業的實用面積、以及露台、工作平台及陽台(如有)的樓面面積，是按照《一手住宅物業銷售條例》第8條計算得出的。其他指明項目的面積(不計算入實用面積)，是按照《一手住宅物業銷售條例》附表2第2部計算得出的。
- 下述所列之平方呎面積是以1平方米=10.764平方呎換算，並以四捨五入至整數平方呎，平方呎與平方米之數字可能有些微差異。



# AREA OF RESIDENTIAL PROPERTIES IN THE DEVELOPMENT

## 發展項目中的住宅物業的面積

Description of Residential Property 物業的描述			Saleable Area (including balcony, utility platform and verandah, if any) sq. metre (sq.ft.) 實用面積 (包括露台, 工作平台及陽台 (如有)) 平方米(平方呎)	Area of other specified items (Not included in the Saleable Area) sq. metre (sq.ft.) 其他指明項目的面積 (不計算入實用面積) 平方米(平方呎)									
Block Name 大廈名稱	Floor 樓層	Unit 單位		Air- conditioning plant room 空調機房	Bay window 窗台	Cockloft 閣樓	Flat roof 平台	Garden 花園	Parking space 停車位	Roof 天台	Stairhood 梯屋	Terrace 前庭	Yard 庭院
Tower 10 第10座	22/F-25/F 22樓至25樓	C	42.892 (462) Balcony 露台: 2.010 (22) Utility Platform 工作平台: 1.491 (16) Verandah 陽台: -	-	0.979 (11)	-	-	-	-	-	-	-	
		D	42.999 (463) Balcony 露台: 2.010 (22) Utility Platform 工作平台: 1.491 (16) Verandah 陽台: -	-	0.979 (11)	-	-	-	-	-	-	-	
	36/F 36樓	A	147.369 (1586) Balcony 露台: 2.859 (31) Utility Platform 工作平台: - Verandah 陽台: -	-	-	-	28.926 (311)	-	-	-	-	-	-
		C	42.892 (462) Balcony 露台: 2.010 (22) Utility Platform 工作平台: 1.491 (16) Verandah 陽台: -	-	0.979 (11)	-	-	-	-	-	-	-	-
		D	42.999 (463) Balcony 露台: 2.010 (22) Utility Platform 工作平台: 1.491 (16) Verandah 陽台: -	-	0.979 (11)	-	-	-	-	-	-	-	-
	37/F 37樓	A	152.180 (1638) Balcony 露台: 2.859 (31) Utility Platform 工作平台: - Verandah 陽台: -	-	-	-	-	-	-	116.054 (1249)	7.800 (84)	-	-
		C	42.892 (462) Balcony 露台: 2.010 (22) Utility Platform 工作平台: 1.491 (16) Verandah 陽台: -	-	0.979 (11)	-	-	-	-	9.014 (97)	-	-	-
		D	42.999 (463) Balcony 露台: 2.010 (22) Utility Platform 工作平台: 1.491 (16) Verandah 陽台: -	-	0.979 (11)	-	-	-	-	23.218 (250)	-	-	-

Notes :

- The residential floors start from 7/F in all towers of the Development.
- There is no Tower 4 in the Development.
- There are no 4/F, 13/F, 14/F, 24/F and 34/F in all towers of the Development.
- There are no 6/F and 19/F in Tower 1 and Tower 2 and no 20/F and 21/F in Tower 6, Tower 7, Tower 9 and Tower 10.
- There are no 2/F in Tower 3, Tower 5, Tower 6, Tower 7, Tower 8, Tower 9 and Tower 10.
- The saleable area of the residential property and the floor area of balcony, utility platform and verandah (if any) are calculated in accordance with Section 8 of the Residential Properties (First-hand Sales) Ordinance; and the areas of the other specified items (not included in the saleable area) are calculated in accordance with Part 2 of Schedule 2 of the Residential Properties (First-hand Sales) Ordinance.
- The areas as specified below in square feet are converted at a rate of 1 square metre = 10.764 square feet and rounded to the nearest whole square foot, which may be slightly different from that shown in square metre.

備註:

- 發展項目內所有座樓之住宅由7樓開始。
- 發展項目不設第4座。
- 發展項目內所有座樓均不設4樓、13樓、14樓、24樓及34樓。
- 第1座及第2座均不設6樓及19樓；第6座、第7座、第9座及第10座均不設20樓及21樓。
- 第3座、第5座、第6座、第7座、第8座、第9座及第10座均不設2樓。
- 住宅物業的實用面積、以及露台、工作平台及陽台(如有)的樓面面積，是按照《一手住宅物業銷售條例》第8條計算得出的。其他指明項目的面積(不計算入實用面積)，是按照《一手住宅物業銷售條例》附表2第2部計算得出的。
- 下述所列之平方呎面積是以1平方米=10.764平方呎換算，並以四捨五入至整數平方呎，平方呎與平方米之數字可能有些微差異。

# FLOOR PLANS OF PARKING SPACES IN THE DEVELOPMENT

## 發展項目中的停車位的樓面平面圖

G/F CAR PARK FLOOR PLAN  
地下停車位平面圖



比例 0米/M 50米/M  
SCALE 

# FLOOR PLANS OF PARKING SPACES IN THE DEVELOPMENT

## 發展項目中的停車位的樓面平面圖

1/F CAR PARK FLOOR PLAN  
1 樓停車位平面圖



比例 0米/M 50米/M  
SCALE

# FLOOR PLANS OF PARKING SPACES IN THE DEVELOPMENT

## 發展項目中的停車位的樓面平面圖

3/F CAR PARK FLOOR PLAN  
3樓停車位平面圖



比例 0米/M 50米/M  
SCALE

# FLOOR PLANS OF PARKING SPACES IN THE DEVELOPMENT

## 發展項目中的停車位的樓面平面圖

5/F CAR PARK FLOOR PLAN  
5樓停車位平面圖

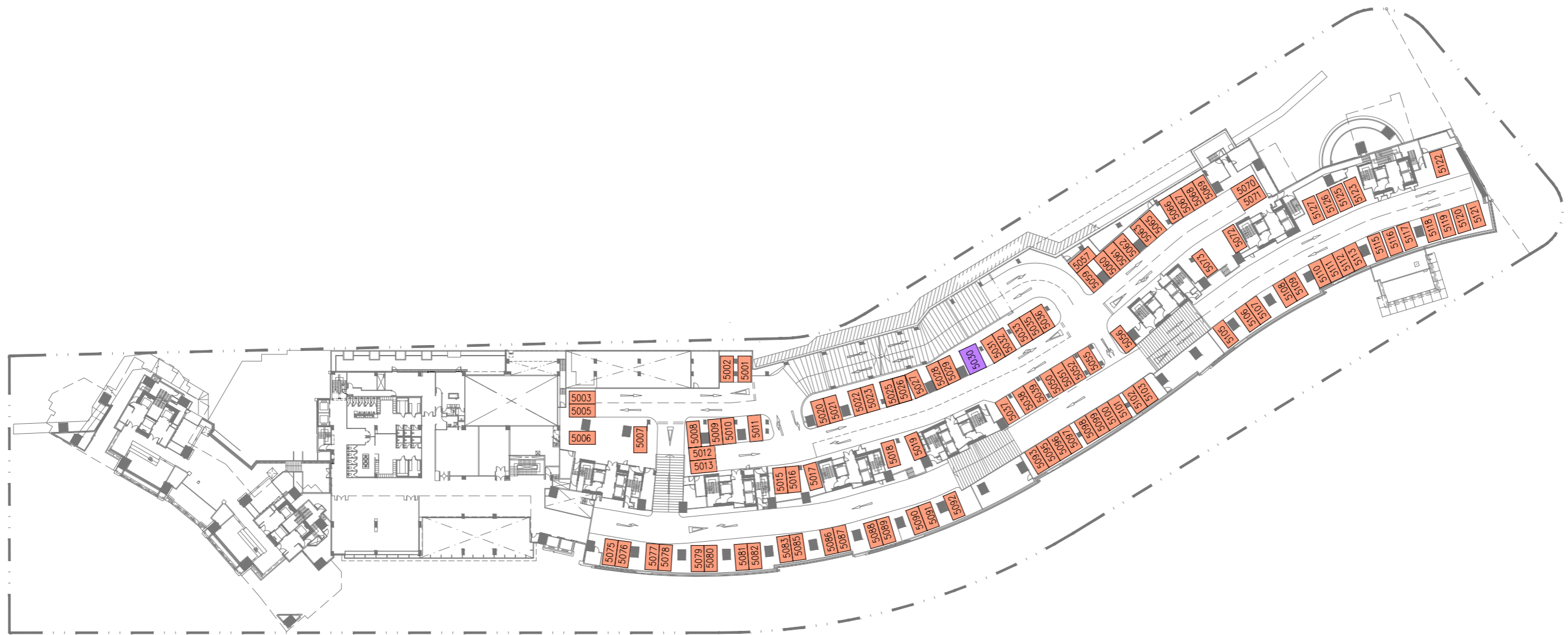

比例 SCALE 0米/M 50米/M

# FLOOR PLANS OF PARKING SPACES IN THE DEVELOPMENT

## 發展項目中的停車位的樓面平面圖

6/F CAR PARK FLOOR PLAN  
6樓停車位平面圖



比例 0米/M 50米/M  
SCALE

# FLOOR PLANS OF PARKING SPACES IN THE DEVELOPMENT

## 發展項目中的停車位的樓面平面圖

### Number, Dimension and Area of Parking Space: 停車位數目、尺寸及面積

Category of Parking Spaces 停車位類別	Number of Parking Space 停車位數目					The Dimensions of Each Parking Space (L x W) (m) 每個停車位尺寸(長x 闊)(米)	Area of Each Parking Space (sq.m) 每個停車位面積(平方米)
	G/F 地下層	1/F 1樓	3/F 3樓	5/F 5樓	6/F 6樓		
Resident's Parking Spaces 住客停車位	106	61	63	102	63	5 x 2.5	12.5
Retail's Parking Spaces 商業停車位	4					5 x 2.5	12.5
Visitor's Parking Spaces 訪客停車位					45	5 x 2.5	12.5
Loading / Unloading Parking Spaces 上/落貨停車位	2	8				11 x 3.5	38.5
Motor Cycle Parking Spaces 電單車停車位		40				2.4 x 1	2.4
Accessible Car Parking Spaces (in Resident's Parking Space) 暢通易達停車位(位於住客停車處)	1	1	1	1	1	5 x 3.5	17.5
Accessible Car Parking Spaces (in Retail's Parking Space) 暢通易達停車位(位於商業停車處)	1					5 x 3.5	17.5

- Resident's Parking Spaces  
住客停車位
- Retail's Parking Spaces  
商業停車位
- Visitor's Parking Spaces  
訪客停車位
- Loading / Unloading Parking Spaces  
上/落貨停車位
- Motor Cycle Parking Spaces  
電單車停車位
- Accessible Car Parking Spaces (in Resident's Parking Space)  
暢通易達停車位(位於住客停車處)
- Accessible Car Parking Spaces (in Retail's Parking Space)  
暢通易達停車位(位於商業停車處)

# SUMMARY OF THE PRELIMINARY AGREEMENT FOR SALE AND PURCHASE

## 臨時買賣合約的摘要

1. A preliminary deposit of 5% is payable on the signing of the preliminary agreement for sale and purchase (the “preliminary agreement”);
  2. The preliminary deposit paid by the purchaser on the signing of the preliminary agreement will be held by a firm of solicitors acting for the owner, as stakeholders;
  3. If the purchaser fails to execute the agreement for sale and purchase within 5 working days after the date on which the purchaser enters into the preliminary agreement —
    - (i) the preliminary agreement is terminated;
    - (ii) the preliminary deposit is forfeited; and
    - (iii) the owner does not have any further claim against the purchaser for the failure.
1. 在簽署臨時買賣合約（“該臨時合約”）時須支付款額為5%的臨時訂金；
  2. 買方在簽署該臨時合約時支付的臨時訂金，會由代表擁有人行事的律師事務所以保證金保存人的身分持有；
  3. 如買方沒有於訂立該臨時合約的日期之後5個工作日內簽立買賣合約—
    - (i) 該臨時合約即告終止；
    - (ii) 有關的臨時訂金即予沒收；及
    - (iii) 擁有人不得就買方沒有簽立買賣合約而針對買方提出進一步申索。



# SUMMARY OF DEED OF MUTUAL COVENANT

## 公契的摘要

A Deed of Mutual Covenant and Management Agreement (“DMC”) has been entered into in respect of the Development.

### A. The common parts of the Development

1. The common parts of the Development comprise the Development Common Areas and Facilities, the Residential Common Areas and Facilities, the Residential Car Park Common Areas and Facilities, the Commercial Common Areas and Facilities (when created) (all as defined below) and all those parts and such of the facilities of the Development designated as common areas and facilities in any Sub-Deed.
2. “Commercial Common Areas and Facilities” means the common areas in the Commercial Accommodation (including but not limited to the Loading/Unloading Space (Commercial)) serving the shops, the commercial, retail or other non-industrial premises and such services, facilities, systems and devices serving the same in common to be designated in a Sub-Deed (if any) in respect of the Commercial Accommodation or any part thereof.
3. “Development Common Areas and Facilities” means and includes the Motor Cycle Parking Spaces, the passages, entrances, walkways, stairways, landings, platforms, open spaces and decks, slopes and retaining walls, covered slope toe area along the rear site boundary (as shown coloured cross hatched green on the plan annexed to the DMC), boundary fence walls, lobbies, the space for the loading and unloading of refuse collection vehicles, service areas, driveways, roadways and pavements, ramps, refuse collection & material recovery chamber, refuse room, transformer room, cable room, LV switch room, HV switch room, pump rooms, sewage treatment plant room (if any), fire services control room, sprinkler control valve room, emergency generator room, fuel tank room, F.S. booster/transfer tanks and pump room, F.S. and sprinkler pump room, street fire hydrant pump room, street fire hydrant water tank, sprinkler water tank, security room, caretaker’s quarters, office for Owners’ Committee (if any) or Owners’ Corporation (when formed), management office, pantry, meter rooms, town gas control room, store rooms, telecommunication broadcasting equipment room, landscaped areas, water features, planters and such of the drains, channels, water mains, sewers, fresh and salt water storage tanks, fresh and salt water intakes and mains, storm water storage tank and drainage connection, communal television and radio aerial systems for reception of television and radio broadcast, telecommunications and broadcasting distribution networks, cable television system (if any), wires, cables and other facilities whether ducted or otherwise which are or at any time may be in under or over or passing through the Lot through which fresh or salt water, sewage, gas, telephone, electricity and other services are supplied to the Development, trees, shrubs and other plants and vegetation, lamp posts and other lighting facilities, fire prevention and fighting equipment and apparatus, security systems and apparatus, ventilation system and any other mechanical systems, devices or facilities installed or provided in the Development intended for common use and benefit of the Development but EXCLUDING the Residential Common Areas and Facilities, the Residential Car Park Common Areas and Facilities, the Commercial Common Areas and Facilities and such areas within the Development the exclusive right and privilege to hold, use, occupy and enjoy which belongs to any particular Owner and such facilities within the Development serving only any particular Owner PROVIDED THAT, where appropriate, if (a) any parts of the Development covered by paragraph (a) of the definition of “common parts” set out in section 2 of the Building Management Ordinance (Cap.344) and/or (b) any parts specified in Schedule 1 to the Building Management Ordinance (Cap.344) and included under paragraph (b) of the definition of “common parts” set out in section 2 of the Building Management Ordinance (Cap.344), shall also be covered by the provisions hereinbefore provided, such parts shall be deemed to have been included as, and shall form part of, the Development Common Areas and Facilities. Such Development Common Areas and Facilities (if and where capable of being shown on plans) are shown coloured green and cross hatched green on the plans certified by the Authorized Person and annexed to the DMC.
4. “Residential Common Areas and Facilities” means and includes the sky gardens (as shown coloured hatched brown on the plans annexed to the DMC), acoustic fins, covered landscape areas, mail boxes, Recreational Areas and Facilities, Visitors’ Parking Spaces, Loading/Unloading Spaces (Residential) (other than refuse collection vehicles) and such of the passages, common corridors and lift lobbies (including wider common corridors and lift lobbies as shown coloured grey on the plans annexed to the DMC), entrances, landings, halls, entrance lobbies, guard rooms, air conditioning platforms, structural walls, curtain walls, external walls and surfaces of the Residential Accommodation, stairways, fire services booster pump room, store rooms, roofs and flat roofs not forming parts of Residential Units, meter rooms and meter spaces and roof thereof and such of the lifts, lift shafts, firemen’s lifts, water tanks, aerials, meters, lighting, drains, channels, sewers, salt and fresh water intakes and mains, wires, cables, air conditioning and ventilation system and other facilities whether ducted or otherwise through which fresh or salt water, sewage, gas, electricity and other services are supplied to the Residential Accommodation, pumps, tanks, sanitary fittings, electrical installations, fittings, equipment and apparatus, fire prevention and fighting equipment and apparatus, security systems and apparatus, ventilation system and such other areas and any other systems, devices or facilities which are at or provided or installed in the Development intended for the common use and benefit of the Owners and residents or tenants of the Residential Accommodation and their bona fide guests or visitors and such other areas within the Lot and such other systems, devices and facilities within the Development as are designated by the First Owner for common use and benefit of the Residential Accommodation in accordance with the DMC but EXCLUDING the Development Common Areas and Facilities, the Residential Car Park Common Areas and Facilities, the Commercial Common Areas and Facilities and such areas within the Development in respect of which the exclusive right and privilege to hold, use, occupy and enjoy the same belongs to any particular Owner and such facilities within the Development serving only any particular Owner PROVIDED THAT, where appropriate, if (a) any parts of the Development covered by paragraph (a) of the definition of “common parts” set out in section 2 of the Building Management Ordinance (Cap.344) and/or (b) any parts specified in Schedule 1 to the Building Management Ordinance (Cap.344) and included under paragraph (b) of the definition of “common parts” set out in section 2 of the Building Management Ordinance (Cap.344), shall also be covered by the provisions hereinbefore provided, such parts shall be deemed to have been included as, and shall form part of, the Residential Common Areas and Facilities. Such Residential Common Areas and Facilities (if and where capable of being shown on plans) are shown coloured brown, hatched brown and grey on the plans certified by Authorized Person and annexed to the DMC.

# SUMMARY OF DEED OF MUTUAL COVENANT

## 公契的摘要

5. “Residential Car Park Common Areas and Facilities” means all those Car Parking Areas other than those specifically designated as Car Parking Spaces and Loading/Unloading Space (Commercial) shown and delineated on the car park layout plan approved by the Director of Lands including the car park exhaust air chamber, electrical room, fan rooms, staircases, protected escape corridors, mechanical/electrical ducts, driveways, control gates, and all the water pipes, drains and wires and cables and lighting in respect of the Residential Car Parking Spaces, fire fighting installation and equipment, curtain walls, external walls and surfaces of the Car Parking Areas, and any other facilities installed for the use and benefit of the Residential Car Parking Spaces and includes such other areas, apparatus, devices, systems and facilities of and in the Development within the Car Parking Areas as are designated by the First Owner as Residential Car Park Common Areas and Facilities but EXCLUDING the Development Common Areas and Facilities, the Residential Common Areas and Facilities, the Commercial Common Areas and Facilities and such areas within the Development the exclusive right and privilege to hold, use, occupy and enjoy which belongs to any particular Owner and such facilities within the Development serving only any particular Owner PROVIDED THAT, where appropriate, if (a) any parts of the Development covered by paragraph (a) of the definition of “common parts” set out in section 2 of the Building Management Ordinance (Cap.344) and/or (b) any parts specified in Schedule 1 to the Building Management Ordinance (Cap.344) and included under paragraph (b) of the definition of “common parts” set out in section 2 of the Building Management Ordinance (Cap.344), shall also be covered by the provisions hereinbefore provided, such parts shall be deemed to have been included as, and shall form part of, the Residential Car Park Common Areas and Facilities. Such Residential Car Park Common Areas and Facilities (if and where capable of being shown on plans) are shown coloured yellow on the plan(s) certified by the Authorized Person and annexed to the DMC.

# SUMMARY OF DEED OF MUTUAL COVENANT

## 公契的摘要

### B. The number of undivided shares assigned to each residential property in the Development

#### Tower 1

Floor	Flat	A	B
	7/F	3,705	3,403
	8/F-18/F & 22/F-36/F (22 storeys)	3,631	3,363
	20/F & 21/F (2 storeys)	3,668	-
	37/F	5,090	-
	38/F & 39/F (Duplex)	6,192	-

#### Tower 2

Floor	Flat	A	B
	7/F	3,532	3,403
	8/F-18/F & 22/F-36/F (22 storeys)	3,455	3,363
	20/F & 21/F (2 storeys)	3,492	-
	37/F	5,032	-
	38/F & 39/F (Duplex)	6,200	-

#### Tower 3

Floor	Flat	A	B	C
	7/F	2,968	2,931	1,408
	8/F-36/F (25 storeys)	2,870	2,828	1,356
	37/F	4,083	-	2,867 <sup>#</sup>
	38/F	4,149	-	-

#### Notes:

1. The residential floors start from 7/F in all towers of the Development.
2. There is no Tower 4 in the Development.
3. There are no 4/F, 13/F, 14/F, 24/F and 34/F in all towers of the Development.
4. There are no 6/F and 19/F in Tower 1 and Tower 2 and no 20/F and 21/F in Tower 6, Tower 7, Tower 9 and Tower 10.
5. There are no 2/F in Tower 3, Tower 5, Tower 6, Tower 7, Tower 8, Tower 9 and Tower 10.
6. <sup>#</sup>means Duplex unit.

# SUMMARY OF DEED OF MUTUAL COVENANT

## 公契的摘要

### Tower 5

Floor	Flat	A	B	C
7/F		2,254	2,251	1,424
8/F-9/F (2 storeys)		2,170	2,147	1,356
10/F		2,135	2,147	1,356
11/F		2,139	2,100	1,356
12/F-37/F (22 storeys)		2,139	2,103	1,356
38/F		3,490	-	2,878 <sup>#</sup>
39/F		3,742	-	-

### Tower 6

Floor	Flat	A	B	C
7/F		2,264	2,232	1,424
8/F – 15/F (6 storeys)		2,184	2,125	1,356
16/F		2,149	2,125	1,356
17/F-19/F & 26/F-37/F (14 storeys)		2,153	2,125	1,356
22/F – 23/F & 25/F (3 storeys)		2,174	-	1,356
38/F		3,396	-	2,916 <sup>#</sup>
39/F		3,874	-	-

Notes:

1. The residential floors start from 7/F in all towers of the Development.
2. There is no Tower 4 in the Development.
3. There are no 4/F, 13/F, 14/F, 24/F and 34/F in all towers of the Development.
4. There are no 6/F and 19/F in Tower 1 and Tower 2 and no 20/F and 21/F in Tower 6, Tower 7, Tower 9 and Tower 10.
5. There are no 2/F in Tower 3, Tower 5, Tower 6, Tower 7, Tower 8, Tower 9 and Tower 10.
6. <sup>#</sup>means Duplex unit.

# SUMMARY OF DEED OF MUTUAL COVENANT

## 公契的摘要

### Tower 7

Floor	Flat	A	B	C
7/F		2,287	2,568	1,457
8/F – 9/F (2 storeys)		2,188	2,501	1,393
10/F		2,141	2,501	1,393
11/F-12/F, 15/F-19/F & 26/F-37/F (18 storeys)		2,144	2,501	1,393
22/F – 23/F & 25/F (3 storeys)		-	2,523	1,393
38/F		3,708	-	3,031 <sup>#</sup>
39/F		4,200	-	-

### Tower 8

Floor	Flat	A	B	C	D
7/F		1,988	1,988	1,081	1,080
8/F-36/F (25 storeys)		1,907	1,903	1,047	1,047
37/F		2,936	-	1,047	1,047
38/F		3,258	-	1,047	1,047

Notes:

1. The residential floors start from 7/F in all towers of the Development.
2. There is no Tower 4 in the Development.
3. There are no 4/F, 13/F, 14/F, 24/F and 34/F in all towers of the Development.
4. There are no 6/F and 19/F in Tower 1 and Tower 2 and no 20/F and 21/F in Tower 6, Tower 7, Tower 9 and Tower 10.
5. There are no 2/F in Tower 3, Tower 5, Tower 6, Tower 7, Tower 8, Tower 9 and Tower 10.
6. <sup>#</sup>means Duplex unit.

# SUMMARY OF DEED OF MUTUAL COVENANT

## 公契的摘要

### Tower 9

Floor	Flat	A	B	C	D
7/F		1,967	2,074	1,083	840
8/F – 19/F & 26/F – 35/F (19 storeys)		1,900	1,920	1,047	799
22/F – 23/F & 25/F (3 storeys)		1,921	-	1,047	799
36/F		2,939	-	1,047	799
37/F		3,414	-	1,088	845

### Tower 10

Floor	Flat	A	B	C	D
7/F		2,095	2,106	803	802
8/F – 12/F (5 storeys)		1,938	1,930	797	799
15/F		1,938	1,902	797	799
16/F-19/F & 26/F-35/F (13 storeys)		1,938	1,906	797	799
22/F – 23/F & 25/F (3 storeys)		-	1,927	797	799
36/F		2,959	-	797	799
37/F		3,436	-	815	845

Notes:

1. The residential floors start from 7/F in all towers of the Development.
2. There is no Tower 4 in the Development.
3. There are no 4/F, 13/F, 14/F, 24/F and 34/F in all towers of the Development.
4. There are no 6/F and 19/F in Tower 1 and Tower 2 and no 20/F and 21/F in Tower 6, Tower 7, Tower 9 and Tower 10.
5. There are no 2/F in Tower 3, Tower 5, Tower 6, Tower 7, Tower 8, Tower 9 and Tower 10.
6. #means Duplex unit.

# SUMMARY OF DEED OF MUTUAL COVENANT

## 公契的摘要

### C. The term of years for which the manager of the Development is appointed

6. Kerry Property Management Services Limited has been appointed under the DMC as the Manager of the Development from the date of the DMC for an initial term of not exceeding two years and such appointment shall continue until terminated as provided in the DMC.

### D. The basis on which the management expenses are shared among the owners of the residential properties in the Development

7. The Owners of Residential Units shall contribute towards the management expenses in the following manner :
  - (a) Each Owner shall pay for every Management Share allocated to any Residential Unit and/or Commercial Accommodation (or any part thereof) and/or Car Parking Space of which he is the Owner a fraction of the total amount assessed under the annual adopted budget for the Development Common Areas and Facilities in which the numerator shall be one and the denominator is equal to the total number of Management Shares in the Development.
  - (b)
    - (i) Each Owner of the Residential Units in addition to the amount payable under sub-paragraph (a) above shall in respect of each Management Share allocated to a Residential Unit of the Residential Accommodation of which he is the Owner pay a fraction of the total amount assessed under the annual adopted budget for the Residential Common Areas and Facilities in which the numerator shall be one and the denominator is equal to the total number of Management Shares allocated to all the Residential Units.
    - (ii) Each Owner of the Residential Units in addition to the amount payable under sub-paragraphs (a) and (b)(i) above shall in respect of each Management Share allocated to a Residential Unit of which he is the Owner pay a fraction of 11.89% of the amount assessed under the annual adopted budget for the Residential Car Park Common Areas and Facilities in which the numerator shall be one and the denominator is equal to the total number of Management Shares allocated to all the Residential Units.
  - (c) In the event that a Sub-Deed is entered into in respect of any component part of the Development and in the Sub-Deed any areas and facilities which do not otherwise fall within the definition of Common Areas and Facilities are designated as common areas and facilities as a consequence of which the same thereby become part of the Common Areas and Facilities a new section of the annual budget shall be established by the Manager such section to cover all expenditure which in the opinion of the Manager (whose decision shall be conclusive save for manifest error) is specifically referable to such common areas and facilities and such expenditure shall be borne by the Owners of that component part of the Development.
  - (d) Where any expenditure for the management and maintenance of the Development and the Lot shall in the reasonable opinion of the Manager be specifically referable to or is being expended for a particular Unit or group of Units and no Owner of any other Unit shall receive any material benefit therefrom, the full amount shall be excluded from the annual budget and shall be paid by the Owner(s) of that particular Unit or group of Units on demand.

### E. The basis on which the management fee deposit is fixed

8. The amount of management fee deposit is equivalent to three months' monthly management contribution payable in respect of each Undivided Share allocated to the Unit.

### F. The area (if any) in the Development retained by the owner for that owner's own use

9. Not applicable.

Note:

For full details, please refer to the DMC. Full script of the DMC is available for free inspection upon request at the sales office during opening hours and copies of the DMC can be obtained upon paying necessary photocopying charges.

# SUMMARY OF DEED OF MUTUAL COVENANT

## 公契的摘要

已經就發展項目簽訂了公契及管理協議(「公契」)。

### A. 發展項目的公用部分

1. 發展項目的公用部分包括發展項目公用地方及設施、住宅公用地方及設施、住宅停車場公用地方及設施、商業公用地方及設施(當設立)(以上各項的定義見下文)，以及在任何副公契中指定為公用地方及設施的發展項目所有部分與設施。
2. 「商業公用地方及設施」指商業樓宇內供店舖、商業、零售或其他非工業處所使用的公用地方(包括但不限於裝卸區(商業))以及在商業樓宇或其任何部分的副公契(如有)中指定供上述公用地方共用的服務、設施、系統及裝置。
3. 「發展項目公用地方及設施」指及包括發展項目內安裝或提供擬供發展項目共用與共享的電單車車位、通道、入口、人行道、樓梯、梯台、平台、露天地方及曬台、斜坡及護土牆、沿著土地後部邊界的有覆蓋物的坡腳範圍(在附於公契的圖則上以綠色交叉斜線顯示)、邊界圍牆、大堂、垃圾車裝卸區、服務區、車道、道路及行人道、坡道、垃圾收集及物料回收房、垃圾房、變壓器房、電纜室、低壓電掣房、高壓電掣房、泵房、污水處理機房(如有)、消防控制室、灑水器控制閥室、緊急發電機房、燃料箱室、消防加壓/輸送水箱及泵房、消防及灑水器泵房、街道消防栓泵房、街道消防栓水箱、灑水器水箱、保安室、管理員室、業主委員會(如有)或業主立案法團(成立後)辦公室、管理處、茶水間、儀錶房、煤氣控制室、儲物室、電訊廣播設備室、園藝區、水裝飾、花槽，以及現時或於任何時候在該地段之內、之下或之上或通過該地段的以使淡水或鹹水、污水、氣體、電話、電力及其他服務得以供應予發展項目的排水渠、水道、總水喉、污水渠、淡水及鹹水儲水箱、淡水及鹹水進水口及總水喉、雨水儲水箱及排水連接設施、用於接收電視及無線電廣播的公用電視及無線電天線系統、電訊及廣播播送網絡、有線電視系統(如有)、電線、電纜及其他設施，不論有無管道；樹木、灌木和其他植物及植被、燈柱與其他照明設施、防火和救火設備及器具、保安系統和器材、通風系統以及任何其他機械系統、裝置或設施，但不包括住宅公用地方及設施、住宅停車場公用地方及設施、商業公用地方及設施，及在發展項目之內而其持有、使用、佔用和享用的獨有權利及特權屬於任何特定業主的地方，以及在發展項目之內僅供任何特定業主使用的設施，但在適當的情況下，如果(a)《建築物管理條例》(第344章)第2條所列「公用部分」定義(a)段所涵蓋的發展項目任何部分，及/或(b)《建築物管理條例》(第344章)附表1指明的並包含在《建築物管理條例》(第344章)第2條所列「公用部分」定義(b)段之下的任何部分，亦被以上規定的條文涵蓋，則該等部分須視為已包含在發展項目公用地方及設施之內並構成其部分。該等發展項目公用地方及設施(如可在圖則上顯示的話)已在經由認可人士核實並附於公契的圖則上以綠色和綠色交叉斜線顯示。
4. 「住宅公用地方及設施」指及包括發展項目現有的或在其內提供或安裝擬供業主和住宅樓宇住戶或租客及其真正客人或訪客共用與共享的空中花園(在附於公契的圖則上以棕色斜線顯示)、隔聲簷、有覆蓋物的園藝區、信箱、康樂區及設施、訪客車位、裝卸區(住宅)(垃圾車除外)、通道、公用走廊和電梯大堂(包括在附於公契的圖則上以灰色顯示的加闊公用走廊和電梯大堂)、入口、梯台、廳堂、入口大堂、警衛室、空調機平台、結構牆、幕牆、住宅樓宇外牆及表面、樓梯、消防加壓泵房、儲物室、不構成住宅單位一部分的天台及平台、儀錶房和儀錶區及其頂蓋、電梯、電梯槽、消防員電梯、水箱、天線、儀錶、照明、排水渠、水道、污水渠、鹹水及淡水進水口和總水喉、電線、電纜、空調和通風系統，以及將淡水或鹹水、污水、氣體、電力及其他服務供應予住宅樓宇的其他設施，不論有無管道；泵、水箱、衛生裝置、電力裝置；裝置、設備及儀器、防火和救火設備及器具、保安系統和器材、通風系統和其他地方，及任何其他系統、裝置或設施，以及被第一業主根據公契指定供住宅樓宇共用與共享的發展項目內其他系統、裝置及設施，但不包括發展項目公用地方及設施、住宅停車場公用地方及設施、商業公用地方及設施，及在發展項目之內而其持有、使用、佔用和享用的獨有權利及特權屬於任何特定業主的地方，以及在發展項目之內僅供任何特定業主使用的設施，但在適當的情況下，如果(a)《建築物管理條例》(第344章)第2條所列「公用部分」定義(a)段所涵蓋的發展項目任何部分，及/或(b)《建築物管理條例》(第344章)附表1指明的並包含在《建築物管理條例》(第344章)第2條所列「公用部分」定義(b)段之下的任何部分，亦被以上規定的條文涵蓋，則該等部分須視為已包含在住宅公用地方及設施之內並構成其部分。該等住宅公用地方及設施(如可在圖則上顯示的話)已在經由認可人士核實並附於公契的圖則上以棕色和棕色斜線及灰色顯示。
5. 「住宅停車場公用地方及設施」指除經地政總署署長批准的車位平面圖上顯示及劃定的具體指定為車位及裝卸區(商業)以外的所有泊車區，包括涉及住宅車位的停車場排氣室、電力房、電扇房、樓梯、防護逃生走廊、機電槽、車道、控制閘以及所有水管、排水渠、電線、電纜及照明；泊車區的救火裝置及設備、幕牆、外牆及表面，以及裝設用於住宅車位用途及利益的任何其他設施，並包括第一業主指定為住宅停車場公用地方及設施的泊車區之內屬於發展項目或在發展項目內的其他地方、器材、裝置、系統及設施，但不包括發展項目公用地方及設施、住宅公用地方及設施、商業公用地方及設施，及在發展項目之內而其持有、使用、佔用和享用的獨有權利及特權屬於任何特定業主的地方，以及在發展項目之內僅供任何特定業主使用的設施，但在適當的情況下，如果(a)《建築物管理條例》(第344章)第2條所列「公用部分」定義(a)段所涵蓋的發展項目任何部分，及/或(b)《建築物管理條例》(第344章)附表1指明的並包含在《建築物管理條例》(第344章)第2條所列「公用部分」定義(b)段之下的任何部分，亦被以上規定的條文涵蓋，則該等部分須視為已包含在住宅停車場公用地方及設施之內並構成其部分。該等住宅停車場公用地方及設施(如可在圖則上顯示的話)已在經由認可人士核實並附於公契的圖則上以黃色顯示。



# SUMMARY OF DEED OF MUTUAL COVENANT

## 公契的摘要

### B. 分配予發展項目中每個住宅物業的不分割份數數目

#### 第1座

樓層	單位	A	B
7樓		3,705	3,403
8樓-18樓及22樓-36樓 (22層)		3,631	3,363
20樓及21樓 (2層)		3,668	-
37樓		5,090	-
38樓及39樓 (複式)		6,192	-

#### 第2座

樓層	單位	A	B
7樓		3,532	3,403
8樓-18樓及22樓-36樓 (22層)		3,455	3,363
20樓及21樓 (2層)		3,492	-
37樓		5,032	-
38樓及39樓 (複式)		6,200	-

#### 第3座

樓層	單位	A	B	C
7樓		2,968	2,931	1,408
8樓-36樓 (25層)		2,870	2,828	1,356
37樓		4,083	-	2,867 <sup>#</sup>
38樓		4,149	-	-

#### 備註：

- 發展項目內所有座樓之住宅由7樓開始。
- 發展項目不設第4座。
- 發展項目內所有座樓均不設4樓、13樓、14樓、24樓及34樓。
- 第1座及第2座均不設6樓及19樓；第6座、第7座、第9座及第10座均不設20樓及21樓。
- 第3座、第5座、第6座、第7座、第8座、第9座及第10座均不設2樓。
- <sup>#</sup>為複式單位。

# SUMMARY OF DEED OF MUTUAL COVENANT

## 公契的摘要

### 第5座

樓層	單位	A	B	C
7樓		2,254	2,251	1,424
8樓-9樓 (2層)		2,170	2,147	1,356
10樓		2,135	2,147	1,356
11樓		2,139	2,100	1,356
12樓-37樓 (22層)		2,139	2,103	1,356
38樓		3,490	-	2,878 <sup>#</sup>
39樓		3,742	-	-

### 第6座

樓層	單位	A	B	C
7樓		2,264	2,232	1,424
8樓-15樓 (6層)		2,184	2,125	1,356
16樓		2,149	2,125	1,356
17樓-19樓及26樓-37樓 (14層)		2,153	2,125	1,356
22樓-23樓及25樓 (3層)		2,174	-	1,356
38樓		3,396	-	2,916 <sup>#</sup>
39樓		3,874	-	-

備註：

- 發展項目內所有座樓之住宅由7樓開始。
- 發展項目不設第4座。
- 發展項目內所有座樓均不設4樓、13樓、14樓、24樓及34樓。
- 第1座及第2座均不設6樓及19樓；第6座、第7座、第9座及第10座均不設20樓及21樓。
- 第3座、第5座、第6座、第7座、第8座、第9座及第10座均不設2樓。
- #為複式單位。

# SUMMARY OF DEED OF MUTUAL COVENANT

## 公契的摘要

### 第7座

樓層	單位	A	B	C
7樓		2,287	2,568	1,457
8樓-9樓 (2層)		2,188	2,501	1,393
10樓		2,141	2,501	1,393
11樓-12樓、15樓-19樓及26樓-37樓 (18層)		2,144	2,501	1,393
22樓-23樓及25樓 (3層)		-	2,523	1,393
38樓		3,708	-	3,031 <sup>#</sup>
39樓		4,200	-	-

### 第8座

樓層	單位	A	B	C	D
7樓		1,988	1,988	1,081	1,080
8樓-36樓 (25層)		1,907	1,903	1,047	1,047
37樓		2,936	-	1,047	1,047
38樓		3,258	-	1,047	1,047

### 第9座

樓層	單位	A	B	C	D
7樓		1,967	2,074	1,083	840
8樓-19樓及26樓-35樓 (19層)		1,900	1,920	1,047	799
22樓-23樓及25樓 (3層)		1,921	-	1,047	799
36樓		2,939	-	1,047	799
37樓		3,414	-	1,088	845

備註：

- 發展項目內所有座樓之住宅由7樓開始。
- 發展項目不設第4座。
- 發展項目內所有座樓均不設4樓、13樓、14樓、24樓及34樓。
- 第1座及第2座均不設6樓及19樓；第6座、第7座、第9座及第10座均不設20樓及21樓。
- 第3座、第5座、第6座、第7座、第8座、第9座及第10座均不設2樓。
- #為複式單位。

# SUMMARY OF DEED OF MUTUAL COVENANT

## 公契的摘要

### 第10座

樓層	單位	A	B	C	D
7樓		2,095	2,106	803	802
8樓-12樓 (5層)		1,938	1,930	797	799
15樓		1,938	1,902	797	799
16樓-19樓及26樓-35樓 (13層)		1,938	1,906	797	799
22樓-23樓及25樓 (3層)		-	1,927	797	799
36樓		2,959	-	797	799
37樓		3,436	-	815	845

備註：

- 發展項目內所有座樓之住宅由7樓開始。
- 發展項目不設第4座。
- 發展項目內所有座樓均不設4樓、13樓、14樓、24樓及34樓。
- 第1座及第2座均不設6樓及19樓；第6座、第7座、第9座及第10座均不設20樓及21樓。
- 第3座、第5座、第6座、第7座、第8座、第9座及第10座均不設2樓。
- #為複式單位。

# SUMMARY OF DEED OF MUTUAL COVENANT

## 公契的摘要

### C. 發展項目管理人的委任年期

6. 根據公契，嘉里物業管理服務有限公司已獲委任為發展項目的管理人，於公契的日期生效，首個任期不超過兩年，而該項任命將會繼續有效直至按公契的規定終止為止。

### D. 管理開支按甚麼基準在發展項目中的住宅物業業主之間分攤

7. 住宅單位的業主須按以下方式分擔管理開支：

- (a) 每名業主須就其作為業主的任何住宅單位及/或商業樓宇(或其任何部分)及/或車位所分攤的每一管理份數，支付根據發展項目公用地方及設施之已通過年度預算案評定的總金額的一個分數數額，其分子是一，分母則相等於發展項目管理份數的總數。
- (b) (i) 除以上(a)分段之下應繳的金額外，住宅單位每名業主還須就其作為業主的住宅樓宇之住宅單位所分攤的每一管理份數，支付根據住宅公用地方及設施已通過年度預算評定的總金額的一個分數數額，其分子是一，分母則相等於所有住宅單位所分攤的管理份數總數。
- (ii) 除以上(a)及(b)(i)分段之下應繳的金額外，住宅單位每名業主還須就其作為業主的住宅單位所分攤的每一管理份數，支付根據住宅停車場公用地方及設施已通過年度預算評定的金額當中11.89%的一個分數數額，其分子是一，分母則相等於所有住宅單位所分攤的管理份數總數。
- (c) 倘若已就發展項目任何組成部分訂立了副公契，而在副公契中任何不為公用地方及設施定義涵蓋的地方及設施均被指定為公用的地方與設施，其結果是該等公用的地方與設施成為公用地方及設施的一部分，則管理人須在年度預算中設立一個新欄目，用以涵蓋管理人認為(除有明顯錯誤外，管理人的決定是最終決定)專門歸結於該等公用的地方與設施的所有支出，而該等支出須由發展項目該組成部分的業主承擔。
- (d) 如果管理人合理地認為，發展項目及該地段的任何管理與維修保養支出專門歸結於個別單位或一組單位，或是為個別單位或一組單位而作出的，而任何其他單位的業主沒有從中取得任何實質利益，則該等全部款項須從年度預算中剔除，並由該個單位或該組單位的業主按要求支付。

### E. 計算管理費按金的基準

8. 管理費按金金額相等於須就有關單位所分攤之每一不分割份數支付的每月管理開支的三個月金額。

### F. 業主在發展項目中保留作自用的範圍(如有)

9. 不適用。

備註：  
如欲知悉全部詳情，請參閱公契。完整的公契現存於售樓處，於開放時間可按要求供免費查閱。在支付所需影印費後，亦可取得公契之複印本。

### 1. The lot number of the land on which the Development is situated

The Development is constructed on Ap Lei Chau Inland Lot No.129 (the “Lot”).

### 2. The term of years under the lease

The lease term of the Lot granted under Conditions of Sale No.12337 (as modified by a Modification Letter dated 9 November 2005 registered in the Land Registry by memorial no. 05111500180018 and a Modification Letter dated 27 February 2007 registered in the Land Registry by memorial no. 07030100250018) (collectively as the “Land Grant”) commences from 25 January 1995 until 30 June 2047.

### 3. User restrictions applicable to that land :-

The Lot or any part thereof or any building or part of any building erected or to be erected thereon shall not be used for any purpose other than for non-industrial (excluding godown, hotel, petrol filling station) purposes.

### 4. Indemnity by Purchaser

General Condition No.14 of the Land Grant stipulates that :-

“The Purchaser shall indemnify and keep indemnified the Government against all actions, proceedings, liabilities, demands, costs, expenses and claims whatsoever arising from any damage caused to adjacent or adjoining land where such damage has, in the opinion of the Director (whose opinion shall be final and binding upon the Purchaser), arisen out of any development or redevelopment affecting the lot or part thereof or out of any other works which the Purchaser is required to undertake in compliance with these Conditions.”

### 5. Maintenance

General Condition No.16 of the Land Grant stipulates that :-

“(a) The Purchaser shall throughout the tenancy having built or rebuilt (which word refers to redevelopment as contemplated in sub-clause (b) below) in accordance with these Conditions (as defined in General Condition No.22 hereof):

- (i) maintain all buildings in accordance with the approved design, disposition and any approved building plans without variation or modification thereto;
  - (ii) maintain all buildings erected or which may hereafter be erected in accordance with these Conditions or any subsequent contractual variation of them, in good and substantial repair and condition and in such repair and condition deliver up the same at the expiration or sooner determination of the tenancy.
- (b) In the event of the demolition at any time during the tenancy of any building then standing on the lot or any part thereof the Purchaser shall replace the same either by sound and substantial building or buildings of the same type and of no less gross floor area or by building or buildings of such type and value as shall be approved by the Director. In the event of demolition as aforesaid the Purchaser shall within one month of such demolition apply to the Director for consent to carry out building works for the redevelopment of the lot and upon receiving such consent shall within three months thereof commence the necessary works of redevelopment and shall complete the same to the satisfaction of and within such time limit as is laid down by the Director.”

### 6. Private streets, roads and lanes

General Condition No. 18 of the Land Grant stipulates that :-

“Any private streets, roads and lanes which by these Conditions are required to be formed shall be sited to the satisfaction of the Director and included in or excluded from the area to be leased as may be determined by him and in either case shall be surrendered to the Government free of cost if so required. If the said streets, roads and lanes are surrendered to the Government, the surfacing, kerbing, draining (both foul and storm water-sewers), channelling and road lighting thereof shall be carried out by the Government at the expense of the Purchaser and thereafter they shall be maintained at public expense. If the said private streets, roads and lanes remain part of the area to be leased, they shall be lighted, surfaced, kerbed, drained, channelled and maintained by and at the expense of the Purchaser in all respects to the satisfaction of the Director and the Director may carry out or cause to be carried out the installation and maintenance of road lighting for the sake of public interest as required. The Purchaser shall bear the capital cost of installation of road lighting and allow free access and egress to and from the area to be leased to workmen and vehicles for the purpose of installation and maintenance of the road lighting.”

### 7. Building covenant

Special Condition No. (2) of the Land Grant stipulates that :-

“The Purchaser shall develop the lot by the erection thereon of a building or buildings complying in all respects with these Conditions and all Ordinances, bye-laws and regulations relating to building, sanitation and planning which are or may at any time be in force in the Hong Kong Special Administrative Region (herein referred to as “Hong Kong”), such building or buildings to be completed ad made fit for occupation on or before the 31st day of December 2010.”

### 8. Landscaping

Special Condition No. (6) of the Land Grant stipulates that :-

“The Purchaser shall at his own expense landscape and plant with trees and shrubs any portion of the lot and podium (if any) not built upon and thereafter maintain and keep the same in a safe, clean, neat, tidy and healthy condition all to the satisfaction of the Director.”

### 9. Cutting away

Special Condition No. (18) of the Land Grant stipulates that :-

“(a) Where there is or has been any cutting away, removal or setting back of any land, or any building-up or filling-in or any slope treatment works of any kind whatsoever, whether with or without the prior written consent of the Director, either within the lot or on any Government land, which is or was done for the purpose of or in connection with the formation, levelling or development of the lot or any part thereof or any other works required to be done by the Purchaser under these Conditions, or for any other purpose, the Purchaser shall at his own expense carry out and construct such slope treatment works, retaining walls or other support, protection, drainage or ancillary or other works as shall or may then or at any time thereafter be necessary to protect and support such land within the lot and also any adjacent or adjoining Government or leased land and to obviate and prevent any falling away, landslip or subsidence occurring thereafter. The Purchaser shall at all times during the term hereby agreed to be granted maintain at his own expense the said land, slope treatment works, retaining walls or other support, protection, drainage or ancillary or other works in good and substantial repair and condition to the satisfaction of the Director.

- (b) Nothing in sub-clause (a) of this Special Condition shall prejudice the Government's rights under these Conditions, in particular Special Condition No. (17) hereof.
- (c) In the event that as a result of or arising out of any formation, levelling, development or other works done by the Purchaser or owing to any other reason, any falling away, landslip or subsidence occurs at any time, whether in or from any land within the lot or from any adjacent or adjoining Government or leased land, the Purchaser shall at his own expense reinstate and make good the same to the satisfaction of the Director and shall indemnify the Government, its agents and contractors from and against all costs, charges, damages, demands and claims whatsoever which shall or may be made, suffered or incurred through or by reason of such falling away, landslip or subsidence.
- (d) In addition to any other rights or remedies herein provided for breach of any of these Conditions, the Director shall be entitled by notice in writing to call upon the Purchaser to carry out, construct and maintain the said land, slope treatment works, retaining walls, or other support, protection, and drainage or ancillary or other works or to reinstate and make good any falling away, landslip or subsidence, and if the Purchaser shall neglect or fail to comply with the notice to the satisfaction of the Director within the period specified therein, the Director may forthwith execute and carry out any necessary works and the Purchaser shall on demand repay to the Government the cost thereof, together with any administrative and professional fees and charges."

### 10. Anchor maintenance

Special Condition No. (20) of the Land Grant stipulates that :-

"Where prestressed ground anchors have been installed, upon development or redevelopment of the lot or any part thereof, the Purchaser shall at his own expense carry out regular maintenance and regular monitoring of the prestressed ground anchors throughout their service life to the satisfaction of the Director and shall supply to the Director such reports and information on all such monitoring works as the Director may from time to time in his absolute discretion require. If the Purchaser shall neglect or fail to carry out the required monitoring works, the Director may forthwith execute and carry out the monitoring works and the Purchaser shall on demand repay to the Government the cost thereof."

### 11. Spoil or debris

Special Condition No. (21) of the Land Grant stipulates that :-

- (a) In the event of spoil or debris from the lot or from other areas affected by any development of the lot being eroded and washed down onto public lanes or roads or into or onto road-culverts, foreshore or seabed, sewers, storm-water drains or nullahs or other Government properties, the Purchaser shall be held responsible and shall at his own expense remove the spoil and debris from and make good any damage done to the public lanes or roads or road-culverts, sewers, storm-water drains or nullahs, foreshore or seabed or other Government properties. The Purchaser shall indemnify the Government against all actions, claims and demands arising out of any damage or nuisance to private property caused by such erosion and washing down.
- (b) Notwithstanding sub-clause (a) of this Special Condition the Director may (but is not obliged to), upon the written request of the Purchaser and at the cost of the Purchaser, remove the spoil and debris from and make good any damage done to the public lanes or roads or road-culverts, sewers, storm-water drains or nullahs, foreshore or seabed or other Government properties referred to in the said sub-clause (a). "

### 12. Green hatched black areas

Special Condition No. (23) of the Land Grant stipulates that :-

- (a) The Purchaser shall at his own expense carry out and complete to the satisfaction of the Director such geotechnical investigations and such slope treatment, landslide preventive, mitigation and remedial works on the areas shown coloured green hatched black on the plan marked "PLAN A" annexed hereto (hereinafter referred to as "the Green Hatched Black Areas") as the Director in his absolute discretion may require and shall, at all times during the term hereby agreed to be granted, at his own expense, maintain in good and substantial repair and condition to the satisfaction of the Director the Green Hatched Black Areas including all land, slope treatment works, earth-retaining structures, drainage and any other works therein and thereon. In the event that any landslip, subsidence or falling away occurs within the Green Hatched Black Areas at any time during the term hereby agreed to be granted, the Purchaser shall at his own expense reinstate and make good the same to the satisfaction of the Director together with any adjacent or adjoining areas which, in the opinion of the Director (whose decision shall be final and binding on the Purchaser), have also been affected. The Purchaser shall indemnify the Government, its agents and contractors against all claims, proceedings, costs, damages and expenses whatsoever incurred by reason of such landslip, subsidence or falling away. The Purchaser shall ensure at all times that there shall be no illegal excavation or dumping on the Green Hatched Black Areas and, subject to the prior written approval of the Director, the Purchaser may erect fences or other barriers for the prevention of such illegal excavation or dumping. In addition to any other rights or remedies the Director may have in respect of any breach of these Conditions, the Director may at any time by notice in writing call upon the Purchaser to carry out such geotechnical investigations, slope treatment, landslip preventive, mitigation and remedial works and to maintain, reinstate and make good any land, structure or works affected by such landslip, subsidence or falling away, and if the Purchaser shall neglect or fail to comply with such notice to the satisfaction of the Director within the period specified therein, the Director may, after the expiry of such period, execute and carry out the required works and the Purchaser shall on demand repay to the Government the cost thereof.
- (b) Notwithstanding sub-clause (a) of this Special Condition, the obligations and rights of the Purchaser in respect of the Green Hatched Black Areas or any part thereof under this Special Condition shall absolutely determine upon the Government giving to the Purchaser notice to that effect, and no claim for compensation shall be made against the Government or the Director or his authorized officer by the Purchaser in respect of any loss, damage or disturbance suffered or any expense incurred as a result of such determination. However, such determination shall be without prejudice to any rights or remedies of the Government in respect of any antecedent breach, non-performance or non-observance of the said sub-clause (a). "

### 13. Utility services

Special Condition No. (24) of the Land Grant stipulates that :-

“The Purchaser shall take or cause to be taken all proper and adequate care, skill and precautions at all times and particularly during any construction, maintenance, renewal or repair work to avoid doing any damage to any Government or other existing drain, waterway or watercourse (including water main), footpath, sewer, nullah, pipe, cable, wire, utility service or any other works or installations (all together hereinafter referred to as “the Works and Services”) being or running upon, over, under or adjacent to the lot or any part thereof or the Green Hatched Black Areas or the Outside Areas referred to in Special Condition No. (60) hereof or any combination thereof, provided that the Purchaser before carrying out any such work as aforesaid shall make or cause to be made such proper search and enquiry as may be necessary to ascertain the present position and levels of any of the Works and Services, and shall submit his proposals for dealing with any of the Works and Services in writing to the Director for his approval in all respects, and shall not carry out any work whatsoever until the Director shall have given his written approval to the works and to such proposals aforesaid, and shall comply with any requirement of the Director in respect of the Works and Services, and shall bear the cost of meeting such requirements including the cost of any necessary diversion, relaying or reinstatement, and except as provided in Special Condition No. (29) hereof shall at his own expense in all respects repair, make good and reinstate to the satisfaction of the Director any damage or disturbance caused to the surface of the lot or any part thereof or the Green Hatched Black Areas or the Outside Areas or any combination thereof or any of the Works and Services running on, over, under or adjacent to the lot or any part thereof or the Green Hatched Black Areas or the Outside Areas or any combination thereof in any manner arising out of any such construction, maintenance, renewal or repair work. If the Purchaser fails to carry out any such necessary diversion, relaying, repairing, making good and reinstatement of the lot or any part thereof or the Green Hatched Black Areas or the Outside Areas or any combination thereof or of any of the Works and Services to the satisfaction of the Director, he, the Director, may carry out any such diversion, relaying, repairing, reinstatement or making good as he considers necessary and the Purchaser shall pay to the Government on demand the cost of such works.”

### 14. Damage to public roads

Special Condition No. (25) of the Land Grant stipulates that :-

- “(a) The Purchaser shall at his own expense and to the satisfaction of the Director make good any damage done to adjoining public roads including street furniture by the Purchaser, his contractors or sub-contractors or his or their workmen or vehicles or by any spoil from the lot.
- (b) Notwithstanding sub-clause (a) of this Special Condition the Director may (but is not obliged to), upon the written request of the Purchaser and at the cost of the Purchaser, make good any damage done to the adjoining public roads including street furniture referred to in the said sub-clause (a).”

### 15. Construction of drains and channels

Special Condition No. (27) of the Land Grant stipulates that :-

“The Purchaser shall construct and maintain at his own expense and to the satisfaction of the Director such drains and channels, whether within the boundaries of the lot or on Government land, as the Director may consider necessary to intercept and convey into the nearest stream-course, catchpit, channel or storm-water drain all storm-water or rain-water falling or flowing on to the lot, and the Purchaser shall be solely liable for and shall indemnify the Government and its officers from and against all actions, claims and demands arising out of any damage or nuisance caused by such storm-water or rain-water”

### 16. Drainage Reserve

Special Condition No. (28) of the Land Grant stipulates that :-

- “(a) The Purchaser shall:
- (i) on or before the 31st day of December 2010, at his own expense and in all respects to the satisfaction of the Director, form, construct and surface the area shown coloured pink hatched black on the plan marked “PLAN A” annexed hereto (hereinafter referred to as “the Drainage Reserve”);
  - (ii) on or before the 31st day of December 2010, at his own expense and in all respects to the satisfaction of the Director, provide, lay and construct such sewers and drains, culverts, manholes with covers, access and other structures (hereinafter collectively referred to as “the Structures”) for and in connection with the formation, construction and surfacing of the Drainage Reserve as the Director at his sole discretion may require, in such manner, at such levels, with such materials and to such standards, specifications and design as may be approved by the Director; and
  - (iii) maintain at his own expense and in all respects to the satisfaction of the Director, the Structures in good condition until a letter from the Director indicating that these Conditions have been complied with to his satisfaction has been issued.
- (b) (i) No building or structure or support for any building or structure except the Structures shall be erected or constructed within the Drainage Reserve.
- (ii) Notwithstanding sub-clause (b)(i) of this Special Condition, with the prior written consent of the Director and subject to such terms and conditions as he may impose, the Purchaser may erect or permit to be erected on the Drainage Reserve:
- (I) a minor structure or structures such as boundary walls and fences provided that if and when required by the Director, the Purchaser shall at his own expense, within the period specified by and in all respects to the satisfaction of the Director, remove or demolish such structure or structures and reinstate the Drainage Reserve; and
  - (II) a structure or structures provided that there is a clear space extending upwards from ground level on or over the Drainage Reserve to a height of 5.10 metres. For the purpose of this Special Condition, the decision of the Director as to what constitutes the ground level, and the required height above it, shall be final and binding upon the Purchaser.
- (iii) If the Purchaser fails to carry out such removal demolition or reinstatement works referred to in sub-clause (b)(ii)(I) of this Special Condition within the period specified or as required in an emergency, the Director may carry out such works as he may consider necessary and the Purchaser shall pay to the Government on demand the cost of such works.



- (c) The Director and his duly authorized officers, contractors, his or their workmen (hereinafter collectively referred to as “the said authorized persons”) with or without tools, equipment, machinery or motor vehicles shall have the right of unrestricted ingress, egress and regress at all times to, from and through the lot or any part thereof for the purposes of laying, inspecting, repairing, maintaining or renewing drains, sewers, channels, drainage facilities and all other services running across, through or under the Drainage Reserve (hereinafter referred to as “the Utilities”) and the Structures which the Director may require or authorize. No object or material of whatsoever nature which may obstruct access or cause excessive surcharge to the Utilities or the Structures shall be placed within the Drainage Reserve. Where in the opinion of the Director (whose opinion shall be final and binding on the Purchaser), there are objects or material within the Drainage Reserve which may obstruct access or cause excessive surcharge to the Utilities or the Structures, the Director shall be entitled by notice in writing to call upon the Purchaser, at his own expense and in all respects to the satisfaction of the Director, to demolish or remove such objects or material and to reinstate the Drainage Reserve. If the Purchaser shall neglect or fail to comply with such notice within the period specified therein, or as required in an emergency the Director may carry out such removal demolition and reinstatement works as he may consider necessary and the Purchaser shall pay to the Government on demand the cost of such works.
- (d) Save in respect of the reinstatement of any trench excavated in the exercise of the aforesaid rights and powers, the Government and the said authorized persons shall have no liability in respect of any loss, damage, nuisance or disturbance whatsoever caused to or suffered by the Purchaser arising out of or incidental to the exercise by the said authorized persons of the right of unrestricted ingress, egress and regress and in laying, inspecting, repairing, maintaining and renewing the Utilities and the Structures conferred under sub-clause (c) of this Special Condition, and no claim shall be made against the Government or the said authorized persons by the Purchaser in respect of any such loss, damage, nuisance or disturbance.”

### 17. Damage to nullahs etc.

Special Condition No. (29) of the Land Grant stipulates that :-

- “(a) Any damage or obstruction caused by the Purchaser, his servants or agents to any nullah, sewer, storm-water drain or water main within or adjoining the lot shall be made good by the Government at the cost of the Purchaser, and the amount due in respect thereof shall be paid on demand to the Government by the Purchaser.
- (b) Notwithstanding sub-clause (a) of this Special Condition, the Purchaser shall, at the request of the Director, make good such damage or obstruction as specified by the Director at his own expense and in all respects to the satisfaction of the Director. ”

### 18. Connecting drains and sewers

Special Condition No. (30) of the Land Grant stipulates that :-

“The works of connecting any drains and sewers from the lot to the Government stormwater drains and sewers, when laid and commissioned, may be carried out by the Director who shall not be liable to the Purchaser for any loss or damage thereby occasioned and the Purchaser shall pay to the Government on demand the cost of such connection works. Alternatively, the said connection works may be carried out by the Purchaser at his own expense to the satisfaction of the Director and in such case any section of the said connection works which is constructed within Government land shall upon demand be handed over by the Purchaser to the Government for future maintenance thereof at the expense of the Government and the Purchaser shall pay to the Government on demand the cost of the technical audit in respect of the said connection works.”

### 19. Discharge into sewers etc.

Special Condition No. (36) of the Land Grant stipulates that :-

“The Purchaser shall not discharge directly or indirectly or cause or permit or suffer to be discharged into any public sewer, storm water drain, channel, stream-course or sea any trade effluent or foul or contaminated water or cooling or hot water without the prior written consent of the Director of Environmental Protection, who may as a condition of granting his consent require the Purchaser to provide, operate and maintain at the Purchaser’s own expense, within the lot or otherwise and to the satisfaction of the Director of Environmental Protection suitable works for the treatment and disposal of such trade effluent or foul or contaminated or cooling or hot water.”

### 20. Access for Fire Services appliances and personnel

Special Condition No. (41) of the Land Grant stipulates that :-

“Throughout the term hereby agreed to be granted :

- (a) the Purchaser shall at his own expense and to the satisfaction of the Director of Fire Services :
- (i) provide suitable means of access for the passage of Fire Services appliances and Fire Services personnel to any building or buildings, structure or structures erected or placed or to be erected or placed on the lot;
  - (ii) at all times permit such Fire Services personnel and Fire Services appliances the free and uninterrupted use of such means of access; and
  - (iii) maintain such means of access and keep the same free from obstruction;
- (b) the Purchaser shall permit the Director of Fire Services, his officers, servants or agents at all reasonable times with or without notice to enter upon the lot or any part thereof or any building or buildings, structure or structures or any part thereof erected or placed or to be erected or placed thereon for the purpose of inspecting the same so as to ensure that the requirements referred to in sub-clause (a) of this Special Condition have been complied with.”

### 21. Provision of fire service installations and equipment

Special Condition No. (42) of the Land Grant stipulates that :-

“The Purchaser shall at his own expense and to the satisfaction of the Director of Fire Services provide fire hydrants, fire fighting appliances, water pumping connections and such other fire service installations and equipment (as defined in the Fire Services Ordinance, any regulations made thereunder and any amending legislation) as the Director of Fire Services in his sole discretion shall require within the lot (or, subject to the prior written consent and approval of the Director, on any adjacent or adjoining Government land) and within any building or buildings erected or to be erected thereon at such point or points as the Director of Fire Services may require. The Purchaser shall maintain at his own expense the said fire hydrants, fire fighting appliances, water pumping connections and such other fire service installations and equipment in good condition and to the satisfaction of the Director of Fire Services.”

### 22. Recreational facilities

Special Condition No. (47) of the Land Grant stipulates that :-

- “(a) The Purchaser may erect, construct and provide within the lot such recreational facilities and facilities ancillary thereto (hereinafter referred to as “the Facilities”) as may be approved in writing by the Director. The type, size, design, height and disposition of the Facilities shall also be subject to the prior written approval of the Director.
- (b) The Facilities provided in accordance with sub-clause (a) of this Special Condition shall only be used by any one or more residents of the residential block or blocks erected or to be erected on the lot and their bona fide visitors and by no other person or persons whatsoever.
- (c) For the purpose of calculating the total gross floor area stipulated in Special Condition No. (8)(c) hereof, any part of the Facilities provided within the lot in accordance with sub-clause (a) of this Special Condition which are for the common use and benefit of all the residents of the residential block or blocks erected or to be erected on the lot and their bona fide visitors shall not be taken into account. The remaining part of the Facilities which are not for such use shall be taken into account for such calculation.
- (d) In the event that any part of the Facilities is exempted from the gross floor area calculation pursuant to sub-clause (c) of this Special Condition:
- (i) such part of the Facilities shall be designated as and form part of the Common Areas referred to in Special Condition No. (11) hereof; and
  - (ii) the Purchaser shall at his own expense maintain such part of the Facilities in good and substantial repair and condition and shall operate such part of the Facilities to the satisfaction of the Director.”

### 23. Office accommodation for watchmen and caretakers

Special Condition No. (48)(a) of the Land Grant stipulates that :-

- “(a) In the event of the lot or any part thereof being used for residential purposes, office accommodation for watchmen or caretakers or both may be provided within the lot subject to the following conditions:
- (i) that such accommodation is in the opinion of the Director essential to the safety, security and good management of the residential building or buildings erected or to be erected on the lot;
  - (ii) that such accommodation shall not be used for any purpose other than office accommodation for watchmen or caretakers or both, who are wholly and necessarily employed on the lot; and
  - (iii) the location of any such accommodation shall first be approved in writing by the Director.”

### 24. Quarters for watchmen and caretakers

Special Condition No. (49)(a) of the Land Grant stipulates that :-

- “(a) In the event of the lot or any part thereof being used for residential purposes, quarters for watchmen or caretakers or both may be provided within the lot subject to the following conditions:

- (i) that such quarters shall be located in one of the blocks of residential units erected on the lot or in such other location as may be approved in writing by the Director;
- (ii) that such quarters shall be provided with self-contained toilet, showering, washing and kitchen facilities; and
- (iii) that such quarters shall not be used for any purpose other than the residential accommodation of watchmen or caretakers or both, who are wholly and necessarily employed within the lot.”

### 25. Owners' Corporation/Owners' Committee Office

Special Condition No. (50)(a) of the Land Grant stipulates that :-

- “(a) In the event of the lot or any part thereof being used for residential purposes, one office for the use of the Owners' Corporation or the Owners' Committee may be provided within the lot provided that:
- (i) such office shall not be used for any purpose other than for meetings and administrative work of the Owners' Corporation or Owners' Committee formed or to be formed in respect of the lot and the buildings erected or to be erected thereon; and
  - (ii) the location of any such office shall first be approved in writing by the Director.”

### 26. Parking requirements

Special Condition No. (51) of the Land Grant stipulates that :-

- “(a) Spaces shall be provided within the lot to the satisfaction of the Director for the parking of motor vehicles at the following rates:
- (i) five spaces for every nine residential units or part thereof in the building or buildings erected or to be erected on the lot provided that the total number of the spaces shall not exceed 435 (hereinafter referred to as “the Residential Parking Spaces”);
  - (ii) five spaces for each residential block; and
  - (iii) one space for every 200 square metres or part thereof of gross floor area in the building or buildings erected or to be erected on the lot to be used for non-industrial (excluding residential, office, hotel and petrol filling station) purposes.

For the purpose of calculating the number of spaces to be provided under sub-clause (a)(iii) above, any floor area to be used for parking spaces and loading and unloading purposes shall be excluded.

- (b) Each of the above spaces so provided shall occupy an area of 2.5 metres in width and 5.0 metres in length with a minimum headroom of 2.4 metres provided that any of the said spaces to be used for the parking of motor vehicles by disabled persons as defined in the Road Traffic Ordinance, any regulations made thereunder and any amending legislation shall be of such dimensions as may be approved in writing by the Director.

- (c) (i) The spaces so provided in compliance with sub-clauses (a)(i) and (a)(iii) of this Special Condition shall not be used for any purpose other than for the parking of motor vehicles licensed under the Road Traffic Ordinance, any regulations made thereunder and any amending legislation and belonging to the residents or occupiers of the building or buildings erected or to be erected on the lot and their bona fide guests, visitors or invitees and in particular the said spaces shall not be used for the storage, display or exhibiting of motor vehicles for sale or otherwise.
- (ii) The spaces so provided in compliance with sub-clause (a)(ii) of this Special Condition shall not be used for any purpose other than for the parking of motor vehicles licensed under the Road Traffic Ordinance, any regulations made thereunder and any amending legislation and belonging to the bona fide visitors or invitees to the building or buildings erected or to be erected on the lot and in particular the said spaces shall not be used for the storage, display or exhibiting of motor vehicles for sale or otherwise. Such spaces shall form part of the Common Areas as defined in Special Condition No. (11) (a)(v) hereof.”

### 27. Motorcycle Parking Spaces

Special Condition No. (52) of the Land Grant stipulates that :-

- “(a) Spaces shall be provided within the lot to the satisfaction of the Director for the parking of motor cycles (hereinafter referred to as “the Motorcycle Parking Spaces”) at the rate of not less than 5% and not more than 10% of the number of the Residential Parking Spaces calculated in accordance with Special Condition No. (51)(a)(i) hereof.
- (b) Each of the Motorcycle Parking Spaces provided shall occupy an area of 1.0 metre in width and 2.4 metres in length with a minimum headroom of 2.3 metres. Such spaces shall not be used for any purpose other than for the parking of motor cycles licensed under the Road Traffic Ordinance, any regulations made thereunder and any amending legislation, and belonging to the residents or occupiers of the building or buildings erected or to be erected on the lot and their bona fide guests, visitors or invitees and in particular the said spaces shall not be used for the storage, display or exhibiting of motor vehicles for sale or otherwise.”

### 28. Loading and unloading requirements

Special Condition No. (53) of the Land Grant stipulates that :-

- “(a) Spaces shall be provided within the lot to the satisfaction of the Director for the loading and unloading of goods vehicles at the following rates:
- (i) one space for each block of residential units erected or to be erected on the lot, such loading and unloading space to be located adjacent to or within each block of residential units erected or to be erected on the lot; (For the purpose of this sub-clause (a)(i) neither detached, semi-detached nor terraced houses which are intended for use as single family residences shall be regarded as a block of residential units);
- (ii) one space for every 1,200 square metres or part thereof of gross floor area in the building or buildings erected or to be erected on the lot to be used for non-industrial (excluding residential, office, hotel and petrol filling station) purposes;

The spaces so provided shall each measure 3.5 metres in width and 11.0 metres in length with a minimum headroom of 4.1 metres. Such spaces shall not be used for any purpose other than for the loading and unloading of goods vehicles in connection with the said building or buildings.

For the purpose of calculating the number of spaces to be provided under sub-clause (a)(ii) of this Special Condition, any floor area to be used for parking spaces and loading and unloading purposes shall be excluded.

- (b) One space shall be provided within the lot to the satisfaction of the Director for the loading and unloading of refuse collection vehicles. The space so provided shall have a minimum measurement of 12.0 metres in length and 5.0 metres in width with a minimum headroom of 4.5 metres and shall not be used for any purpose other than for the loading and unloading of refuse collection vehicles. The space so provided shall be laid out in such a manner that on entering or leaving the lot, there shall be no reversing movement of vehicles from or onto the road abutting the lot.”

### 29. Restriction on alienation of Residential Parking Spaces

Special Condition No. (56)(a) and (b) of the Land Grant stipulates that :-

- “(a) The Residential Parking Spaces provided within the lot in accordance with Special Condition No. (51) hereof shall not be used for any purpose other than for the parking of motor vehicles belonging to the residents of the residential units in the building or buildings erected or to be erected on the lot and shall be designated as such on the approved car park layout plan referred to in Special Condition No. (58) hereof.
- (b) The Residential Parking Spaces shall not be:
- (i) assigned except
- (I) together with undivided shares in the lot and the right of exclusive use and possession of a residential unit or units in the building or buildings erected or to be erected on the lot or
- (II) to a person who is already the owner of undivided shares in the lot with the right of exclusive use and possession of a residential unit or units in the building or buildings erected or to be erected on the lot; or
- (ii) underlet except to residents of the residential units in the building or buildings erected or to be erected on the lot.”

### 30. Refuse Collection Chamber

Special Condition No. (57) of the Land Grant stipulates that :-

“The Purchaser shall at his own expense provide and maintain, within the lot, facilities for a comprehensive refuse collection system to the satisfaction of the Director of Food and Environmental Hygiene.”

### 31. Natural terrain / Registration of a plan indicating the location, nature and extent of the Landslip Hazards Study Areas

Special Condition No. (60) of the Land Grant stipulates that :-

# SUMMARY OF LAND GRANT

## 批地文件的摘要

- “(a) (i) The Purchaser hereby acknowledges that the lot may be affected by landslip hazards including boulder falls arising from the areas to the west of the lot (hereinafter referred to as “the Landslip Hazards Study Areas”) due to the nature of the natural terrain. The location, nature and extent of the Landslip Hazards Study Areas shall be decided by the Director of Civil Engineering and Development whose decision shall be final and binding on the Purchaser. The Purchaser shall on or before the 31st day of December 2008, at his own expense carry out and complete to the satisfaction of the Director geotechnical investigation (hereinafter referred to as “the Investigation”) within the lot and on the Landslip Hazards Study Areas for such hazards. No ground investigation shall be carried out on any Government land outside the Landslip Hazards Study Areas without the prior written consent of the Director.
- (ii) A plan approved by the Director of Civil Engineering and Development indicating the location, nature and extent of the Landslip Hazards Study Areas shall be duly registered in the Land Registry against the lot. No transaction (except a tenancy or lease or an agreement for a tenancy or lease permitted by Special Condition No. (9)(c) hereof, a building mortgage under Special Condition No. (9)(d) hereof or such other transactions as the Director may approve) affecting the lot or any part thereof or any building or part of any building erected or to be erected on the lot shall be entered into until after one calendar month from such registration.
- (b) On completion of the Investigation, the Purchaser shall at his own expense carry out any necessary mitigation and stabilisation works within the lot as the Director in his absolute discretion shall require (hereinafter referred to as “the Works”) to protect any building or buildings erected or to be erected on the lot or any part thereof and any residents or occupiers therein and their bona fide guests, visitors and invitees from landslip hazards including boulder falls arising from the Landslip Hazards Study Areas.
- (c) Where it is deemed necessary by the Government or the Purchaser or both to carry out mitigation and stabilisation works (hereinafter referred to as “the Outside Works”) on any Government land including the Landslip Hazards Study Areas (any Government land on or in relation to which the Outside Works are carried out are hereinafter referred to as “the Outside Areas”), the Purchaser shall, upon receipt of the Director’s approval to or request for the Outside Works, at his own expense carry out and complete the Outside Works to the satisfaction of the Director. The Purchaser shall register at his own expense in the Land Registry against the lot a record plan accepted by the Director indicating the location, nature and extent of the Outside Areas and the Outside Works.
- (d) The Purchaser shall at all times during the term hereby agreed to be granted, maintain at his own expense the Works, the Outside Works and the Outside Areas in good substantial repair and conditions to the satisfaction of the Director to ensure the continuing functioning of the Works and the Outside Works. In addition to any rights or remedies the Government may have against the Purchaser for breach of the Purchaser’s obligations to maintain the Works, the Outside Works and the Outside Areas as herein provided, the Director shall be entitled by notice in writing to call upon the Purchaser to carry out such maintenance works as the Director shall in his absolute discretion deem fit. If the Purchaser shall neglect or fail to comply with such notice to the satisfaction of the Director within the period specified therein, the Director may forthwith execute and carry out the required maintenance works and the Purchaser shall on demand repay the Government the cost thereof, together with any administrative and professional fees and charges.
- (e) The Investigation, the Works and the Outside Works shall in all respects comply with the Buildings Ordinance, any regulations made thereunder, any amending legislation and any other relevant Government legislation.
- (f) For the purpose only of carrying out the Investigation, the Works and the Outside Works and inspecting and maintaining the Works, the Outside Works and the Outside Areas, the Purchaser shall have the right of ingress or egress to and from the Outside Areas subject to such terms and conditions as may be imposed by the Director at his sole discretion.
- (g) In the event that as a result of or arising out of any works being carried out or having been carried out pursuant to the terms of this Special Condition any damage is done to any Government land including the Outside Areas or any land outside the lot, the Purchaser shall make good such damage at his own expense and in all respects to the satisfaction of the Director.
- (h) The Purchaser hereby indemnifies and shall keep indemnified the Government from and against all actions, proceedings, liabilities, claims, costs and demands whatsoever arising out of or incidental to any works being carried out or having been carried out pursuant to the terms of this Special Condition or the omission, neglect or default by the Purchaser to carry out any such works or any landslip hazard including boulder falls from the Outside Areas including but without limitation to any damage to or loss of properties and life or personal injuries or any interference or damage to the graves adjoining or within the Outside Areas.”

Note:

1. The location of the referred “green hatched black area” and “pink hatched black area” are indicated in a plan shown in Section AR of this Sales Brochure.
2. For full details, please refer to the Land Grant. Full script of the Land Grant is available for free inspection upon request at the sales office during opening hours and copies of the Land Grant can be obtained upon paying necessary photocopying charges.

### 1. 發展項目所位於的土地的地段編號

發展項目興建於鴨脷洲內地段第129號(「該地段」)。

### 2. 有關租契規定的年期

根據賣地條件第12337號(經日期為2005年11月9日並在土地註冊處註冊(註冊摘要編號:05111500180018)的修訂書修訂,又經日期為2007年2月27日並在土地註冊處註冊(註冊摘要編號:07030100250018)的修訂書修訂)(合稱「批地文件」),該地段的批地年期由1995年1月25日起至2047年6月30日止。

### 3. 適用於該土地的用途限制:

該地段或其任何部分或在該地段或其任何部分之上已建或擬建的任何建築物不得用作非工業(不包括倉庫、酒店、加油站)用途以外的任何其他用途。

### 4. 由買方作出彌償

批地文件一般條件第14條規定:

「對於相鄰或毗連的土地所受的任何損害,如署長認為(其意見為終論並對買方有約束力)該等損害是由於影響該地段或其部分的任何發展或重建或買方為符合批地條件而須進行的任何其他工程引起的,則因此而引致的所有訴訟、法律程序、責任、要求、費用、開支及索償,買方須向政府作出彌償並保持政府獲得彌償。」

### 5. 維修保養

批地文件一般條件第16條規定:

「(a)買方須在整個租期期間根據本批地條件(定義見本批地文件一般條件第22條)興建或再興建(該詞語指以下第(b)款提及的重建):

- (i) 按已批准的設計、佈局及任何經批准的建築圖則維修保養所有建築物,不能對其作出改變或更改;
  - (ii) 按批地條件或該等條件任何其後的合約變更,維修保養所有已建或今後興建的所有建築物處於修葺良好堅固的狀況,並在租期期滿或提早終止時以該種狀況交回該等建築物。
- (b) 倘若在租期期間任何時候拆卸當時在該地段或其任何部分存在的任何建築物,買方須以相同類型和不少於原先建築面積的結構穩妥的建築物或署長批准的類型和價值的建築物作為代替。如果作出上述拆卸,買方須在該拆卸的一個月內向署長申請同意以便在該地段進行重建的建築工程,並在收到上述同意後的三個月內展開重建所必要的工程,且須在署長規定的時限內完成工程,達至署長滿意程度。」

### 6. 私家街、路及徑

批地文件一般條件第18條規定:

「按批地文件的要求而須建成的任何私家街、路及徑須設置在署長滿意的地方,及由署長決定是否納入或剔出出租的範圍,無論在那一種情況須在需要時免費退回予政府。上述之街、路及徑若退回予政府,其平整、鋪設路邊石、鋪設排水渠(不論是污水渠或雨水渠)、鋪設渠道及道路照明由政府進行,費用由買方支付,其後之維修保養由公共開支支付。如上述私家街、路及徑仍為出租範圍的一部分,買方須支付其照明、平整、鋪設路邊石、鋪設排水渠、鋪設渠道及維修保養的費用,以在各方面達至署長滿意程度。如因公眾利益需要,署長可進行或促使他人進行道路街燈之安裝及維修保養。買方須負責道路街燈安裝的資本成本及允許工人及車輛為安裝及維修保養道路街燈之目的自由出入該出租範圍。」

### 7. 建築契諾

批地文件特別條件第(2)條規定:

「買方須發展該地段,在其上建造建築物,在各方面符合批地條件及現時或任何時候在香港特別行政區(簡稱「香港」)有效的關於建築、衛生及規劃的一切條例、附例及規例。該等建築物須在2010年12月31日或之前完成並使其適合佔用。」

### 8. 環境美化

批地文件特別條件第(6)條規定:

「買方須自資在該地段及平台(如有)未有興建建築物的任何部分進行環境美化和種植樹木及灌木,其後保持與維持其處於安全、清潔、整潔、整齊及健康狀態,在各方面達至署長滿意程度。」

### 9. 切割

批地文件特別條件第(18)條規定:

- 「(a) 如果現有或曾經作出任何土地切割、移除或退入,或堆積、堆填或任何種類的斜坡處理工程,不論有否經署長事先書面同意,亦不論是在該地段內或任何政府土地內,旨在或有關於該地段或其任何部分之構建、平整或開發,或買方按批地條件須進行的任何其他工程,或作任何其他用途,買方須自費進行與建設為了保護及承托該地段內的土地和任何相鄰或毗連政府土地或已出租土地和為了避免及防止其後發生任何塌方、山泥傾瀉或地陷而在當時或其後任何時間必要的斜坡處理工程、護土牆或其他承托、保護、排水或輔助工程或其他工程。買方須在本批地文件同意授予的年內一切時候自費維修保養該土地、斜坡處理工程、護土牆或其他承托、保護、排水或輔助工程或其他工程處於修葺良好堅固的狀況,達至署長滿意程度。
- (b) 本特別條件(a)款的任何規定,不影響政府在批地條件下的權利,尤其是特別條件第(17)條下的權利。
- (c) 倘若因為任何構建、平整、開發或買方進行的其他工程或任何其他原因而在任何時候導致或引起任何塌方、山泥傾瀉或地陷,不論發生在或來自該地段任何土地或任何相鄰或毗連政府土地或已出租土地,買方須自費復原和修復相關土地以達至署長滿意程度,並對上述塌方、山泥傾瀉或地陷造成政府、其代理人及承判商承受、遭受或產生一切費用、收費、損害、要求及索償作出彌償。」

# SUMMARY OF LAND GRANT

## 批地文件的摘要

- (d) 除了就任何批地條件遭違反而享有批地文件規定的任何其他權利或補救方法外，署長有權發出書面通知要求買方進行、建設及維修保養該土地、斜坡處理工程、護土牆或其他承托、保護及排水或輔助工程或其他工程，或復原和修復任何塌方、山泥傾瀉或地陷。如買方忽視或未能在該通知指定的期限內遵從該通知的要求以達至署長滿意程度，署長可立即執行及進行任何必要工程，而買方須按要求向政府償付該費用連同任何行政費和專業費用及開支。」

### 10. 地樁的維修保養

批地文件特別條件第(20)條規定：

「如果在發展或重建該地段或其任何部分時已安裝預應力地樁，買方須自費在預應力地樁的服務年期定期維修保養與檢查預應力地樁，以達至署長滿意程度，並在署長不時按其絕對酌情權要求時提供上述檢驗工程的報告和資料給署長。如果買方忽視或未能進行上述檢驗工程，署長可立即執行與進行上述檢驗工程。買方須按要求向政府償付該項費用。」

### 11. 廢土或泥頭

批地文件特別條件第(21)條規定：

- (a) 如果該地段或受該地段的任何發展影響的其他範圍有廢土或泥頭被侵蝕及沖落到公眾徑或道路或道路暗渠、前濱或海床、污水渠、雨水渠或明渠或其他政府物業，買方須承擔責任，並自費從公眾徑或道路或道路暗渠、污水渠、雨水渠或明渠、前濱或海床或其他政府物業清除廢土及泥頭，且修復對上述各項造成的損害。買方須對上述由侵蝕及沖落對私人物業導致的任何損害或滋擾而產生的一切訴訟、索償及要求向政府作出彌償。
- (b) 儘管有本特別條件(a)款的規定，惟署長可(但無義務)在買方提出書面要求時並在買方承擔費用的情況下，從以上(a)款所述的公眾徑或道路或道路暗渠、污水渠、雨水渠或明渠、前濱或海床或其他政府物業清除廢土及泥頭，且修復對上述各項造成的損害。」

### 12. 綠色間黑斜線範圍

批地文件特別條件第(23)條規定：

- (a) 買方須在隨附於本批地文件標明為「圖則A」的圖則上綠色間黑斜線顯示的範圍(下稱「綠色間黑斜線範圍」)，自費進行與完成署長按其絕對酌情權要求的土力勘察、斜坡處理、山泥傾瀉之防止、緩解及補救工程，達至署長滿意程度；並且在本批地文件同意授予的年期內一切時候自費維修保養綠色間黑斜線範圍，包括該範圍之內及之上的一切土地、斜坡處理工程、護土構築物、排水渠及任何其他工程，處於修葺良好堅固的狀況，達至署長滿意程度。如於本批地文件同意授予的年期內任何時候，綠色間黑斜線範圍內發生任何山泥傾瀉、地陷或塌方，買方須自費復原及修復該範圍以及署長認為(其決定為終論並對買方有約束力)亦受影響的任何相鄰或毗連範圍，達至署長滿意程度。對於因上述山泥傾瀉、地陷或塌方而招致的所有索償、法律程序、費用、須付損害賠償及開支，買方須向政府、其代理人及承判商作出彌償。買方須確保在一切時候綠色間黑斜線範圍之上沒有非法挖掘或傾倒之情況。在取得署長事先書面批准的前提下，買方可豎設圍牆或其他障礙物以防止出現上述非法挖掘或傾倒情況。若有違反批地條件的情況發生，署長除就該等違反情況而享有任何其他權利或補救方法之外，可於任何時候以書面通知方式要求買方進行上述土力勘察、斜坡處理、山泥傾瀉之防止、緩解及補救工程，並維修保養、復原及修復受上述山泥傾瀉、地陷或塌方影響的任何土地、構築物或工程。如買方忽視或未能在該通知指定的期限內遵從該通知的要求以達至署長滿意程度，署長可於該期限屆滿後執行及進行必要工程，而買方須按要求向政府償付該費用。」

- (b) 儘管有本特別條件(a)款的規定，但買方在本特別條件之下就綠色間黑斜線範圍或其任何部分而有的義務和權利將於政府向買方發出相關通知時完全終止，而買方不得就該項終止導致其遭受的任何損失、損害或干擾或招致的任何開支向政府或署長或其授權人員提出索償。然而，該項終止並不影響政府因買方對上述(a)款的任何先前違反、不履行或不遵守情況而享有的任何權利或補救方法。」

### 13. 公用事業服務

批地文件特別條件第(24)條規定：

「買方須在一切時候，特別是在任何建築、維修保養、翻新或維修工程期間，採取或促使他人採取一切適當及足夠的謹慎措施、技巧及預防措施，避免對該地段或其任何部分、綠色間黑斜線範圍、批地文件特別條件第(60)條所述的外區或上述各項的任何組合之內、之上、之下或相鄰地方存在或通過的任何政府的或其他現有的排水渠、水路或水道(包括水管)、行人小徑、污水渠、明渠、管道、電纜、電線、公用事業服務或任何其他工程或裝置(所有各項下稱「工程及服務」)造成任何損害，惟買方在進行上述任何工程之前，須進行或促使他人進行所需的適當檢索及查詢，以確定任何工程及服務的現時位置及深度，並提交處理任何工程及服務的書面建議給署長，供其在各方面進行審批，且在取得署長對上述工程及建議作出的書面批准之前，不得進行任何工程，並且買方須履行署長對工程及服務的任何要求和承擔為了滿足該等要求而須支出的費用，包括必要的改道、重鋪或復原的費用。除本批地文件特別條件第(29)條另有規定外，買方須自費在一切方面維修、修復及復原由於上述建築、維修保養、翻新或維修工程而以任何方式引致對該地段或其任何部分、綠色間黑斜線範圍、外區或上述各項的任何組合的表面，或該地段或其任何部分、綠色間黑斜線範圍、外區或上述各項的任何組合之上、上面、之下或相鄰地方的工程及服務造成的任何損害或干擾，達至署長滿意程度。如果買方未能對該地段或其任何部分、綠色間黑斜線範圍、外區或上述各項的任何組合或任何工程及服務進行上述必要的改道、重鋪、維修、修復及復原以達至署長滿意程度，署長可進行其認為必要的上述改道、重鋪、維修、修復或彌補工程，而買方須按要求向政府償付該等工程的費用。」

### 14. 對公共道路造成的損害

批地文件特別條件第(25)條規定：

- (a) 買方須自費修復由買方、其承判商或分包商或其工人或車輛或來自該地段的任何廢土而對毗連公共道路(包括街道裝置)造成的任何損害。
- (b) 儘管有本特別條件(a)款的規定，惟署長可(但無義務)在買方提出書面要求時並在買方承擔費用的情況下，修復以上(a)款所述對毗連公共道路(包括街道裝置)造成的任何損害。」

### 15. 建造排水渠及渠道

批地文件特別條件第(27)條規定：

「買方須自費建造及維修保養按署長認為為了將落在或流到該地段的所有暴雨或雨水截取並引導至最近的河道、集水井、渠道或雨水渠而屬必要的排水渠及渠道，不論其在該地段邊界內或在政府土地內，以達至署長滿意程度，而買方須對上述暴雨或雨水導致的任何損害或滋擾所產生的一切訴訟、索償及要求負全責並向政府及其人員作出彌償。」

### 16. 渠務預留區域

批地文件特別條件第(28)條規定：

「“(a)買方須：

- (i) 在2010年12月31日或之前，自費構建、建造隨附於批地文件標明為「圖則A」的圖則上粉紅色間黑斜線顯示的範圍(下稱「渠務預留區域」)並平整該範圍的表面，在各方面達至署長滿意程度；
  - (ii) 在2010年12月31日或之前，自費就渠務預留區域的構建、建造及表面平整提供、鋪設及建造署長按其獨自酌情權要求的污水渠及排水渠、暗渠、連蓋沙井、通道及其他構築物(以下合稱「該等構築物」)，其方式、水平、材料、標準、規格及設計須為署長批准者，且須在各方面達至署長滿意程度；及
  - (iii) 自費維修保養該等構築物處於良好狀態以在各方面達至署長滿意程度，直至署長發函表示批地條件已獲遵守致使其滿意為止。
- (b) (i) 除該等構築物外，不得在渠務預留區域內興建或建造建築物、構築物，或支撐任何建築物或構築物的結構。
- (ii) 儘管有本特別條件(b)(i)款的規定，但如取得署長事先書面同意並在遵守其施加的條款及條件的前提下，買方可在渠務預留區域內興建或容許他人興建：
- (I) 小型構築物，例如邊界牆壁及圍牆，但如署長要求時，買方須自費在署長指明的期限內清除或拆卸該構築物和復原渠務預留區域，以在各方面達至署長滿意程度；及
  - (II) 構築物，條件是由渠務預留區域地面向上起計的淨空間須有5.10米。就本特別條件而言，署長對於何謂地面和對地面之上所需高度作出的決定為終論並對買方有約束力。
- (iii) 倘若買方未能在指定期限內或未能按緊急情況所需進行本特別條件第(b)(ii)(I)款所述的清除、拆卸或復原工程，署長可展開其認為必須的工程，而買方須按要求向政府償付該等工程的費用。
- (c) 署長、獲其正式授權的人員、承判商或他們的工人(以下合稱「獲授權的人士」)，不論有否帶同工具、設備、機器或汽車，在一切時候均具有不受限制來回進出及通過該地段或其任何部分的權利，旨在鋪設、檢查、修理、維修保養或翻新署長要求或批准的經過、貫穿或藏於渠務預留區域和該等構築物之下的排水渠、污水渠、渠道、排水設施及一切其他服務(下稱「公用事業設施」)。任何性質的物體或物料，若其可能引起防礙進入或使用公用事業設施或該等構築物或引致其超出荷載，均不得放置於渠務預留區域之內。凡署長認為(其意見為終論並對買方有約束力)渠務預留區域內有物體或物料可能引起防礙進入或使用公用事業設施或該等構築物或引致其超出荷載，署長有權給予買方書面通知要求買方自資拆卸或清除該物體或物料，並復原渠務預留區域，在各方面達至署長滿意程度。如買方忽視或未能於通知指明期限內或緊急情況所需時遵從該項通知，則署長可進行其認為必需的清除、拆卸及復原工程，而買方須按要求向政府償付該等工程的費用。

- (d) 除須將任何因行使上述權利及權力而挖掘的壕溝復原外，對由於獲授權的人士根據本特別條件第(c)款行使不受限制的進出權並且鋪設、檢查、修理、維修保養及翻新公用事業設施及該等構築物而引致或附帶使買方遭受或蒙受的任何損失、損害或干擾，政府及獲授權的人士一概不須負責。買方亦不得向政府或獲授權的人士提出有關任何該等損失、損害、滋擾或干擾的索償。」

### 17. 對明渠等的損害

批地文件特別條件第(29)條規定：

- 「(a) 買方、其受僱人或代理人對該地段之內或毗連的明渠、污水渠、雨水渠或水管造成的任何損害或阻塞，應在買方承擔費用的情況下由政府修復，而買方須按要求向政府支付修復工作的金額。
- (b) 儘管有本特別條件(a)款的規定，惟買方須在署長要求下自費修復署長指明的損害或阻塞，在各方面達至署長滿意程度。」

### 18. 連接排水渠和污水渠

批地文件特別條件第(30)條規定：

「連接該地段的任何排水渠和污水渠至政府的雨水渠及污水渠(如已建及試用)的工程可由署長進行，但署長不須就因此產生的任何損失或損害對買方負責。買方須按要求向政府支付上述連接工程的費用。另一個選擇是，該等連接工程可由買方自費進行，達至署長滿意程度，而在該情況下，上述連接工程的任何一段若在政府土地內修建，須在被要求時由買方交給政府，由政府出資負責以後的維修保養。買方須按要求向政府支付有關上述連接工程技術審核的費用。」

### 19. 排放入污水渠等

批地文件特別條件第(36)條規定：

「未經環境保護署署長事先書面同意，買方不得直接或間接排放或促使、允許或容許他人排放任何工商業污水、髒水、受污染水、冷凍水或熱水進入公眾污水渠、雨水渠、渠道、河道或大海。作為給予同意的條件，環境保護署署長可要求買方自費在該地段之內或之外提供、運作及維修保養合適的處理及處置該等工商業污水、髒水、受污染水、冷凍水或熱水的設施，達至環境保署署長滿意程度。」

### 20. 消防器具及人員的通道

批地文件特別條件第(41)條規定：

「在本批地文件同意授予的整個期限內：

- (a) 買方須自費作出以下各項事宜，達至消防處處長滿意程度：
- (i) 提供適當的通道讓消防設備及消防人員得以進入該地段內已經或將會興建或設置的建築物或構築物；
  - (ii) 在一切時候允許該等消防人員及消防器具暢通無阻地使用該等通道；及
  - (iii) 維修保養該等通道，並保持其暢通無阻；

# SUMMARY OF LAND GRANT

## 批地文件的摘要

- (b) 買方須允許消防處處長、其職員、受僱人或代理人在一切合理時間不論有無作出通知的情況下進入該地段或其任何部分，或該地段內已經或將會興建或設置的建築物或構築物，進行視察以便確保本特別條件(a)款所述的要求已得到遵守。」

### 21. 提供消防裝置及設備

批地文件特別條件第(42)條規定：

「買方須在該地段內(或經署長事先書面同意與批准，在任何相鄰或毗連政府土地)及在其上已建或擬建的建築物內按消防處處長要求的位置，自費提供消防喉轆、消防器具、水泵連接裝置以及消防處處長按其獨自酌情權要求的其他消防裝置及設備(定義見《消防條例》、根據該條例制定的任何規例，以及任何修訂立法)，達至消防處處長滿意程度。買方須自費維修保養上述消防喉轆、消防器具、水泵連接裝置和其他消防裝置及設備處於修繕妥當的狀態，達至消防處處長滿意程度。」

### 22. 康樂設施

批地文件特別條件第(47)條規定：

- 「(a) 買方可於該地段內興建、建造及提供由署長書面批准的康樂設施及其配套設施(下稱「康樂設施」)。康樂設施的種類、大小、設計、高度及佈局亦須事先取得署長書面批准。
- (b) 按照本特別條件(a)款提供的康樂設施僅供該地段已建或擬建住宅大樓的住客及其真正訪客使用，而不得供任何其他人士使用。
- (c) 就計算本批地文件的特別條件第(8)(c)條規定的總建築面積而言，如根據本特別條件(a)款在該地段內提供的康樂設施之任何部分是提供予該地段已建或擬建住宅大樓的所有住戶及其真正訪客共同使用及享用的，該部分不計算在內。並非作此用途的康樂設施其餘部分須計算在內。
- (d) 如康樂設施的任何部分根據本特別條件(c)款而在計算建築面積時獲得豁免：
- (i) 康樂設施的該部分須指定為並構成本批地文件的特別條件第(11)條所指的公用地方之一部分；及
- (ii) 買方須自費維修保養康樂設施的該部分處於修葺良好堅固的狀況並且運作康樂設施的該部分，達至署長滿意程度。」

### 23. 看更和看守員的辦公設施

批地文件特別條件第(48)(a)條規定：

- 「(a) 倘若該地段或其任何部分用作住宅用途，則可在該地段內提供看更或看守員或兩者的辦公設施，但須受下列條件規限：
- (i) 署長認為該等設施對於該地段已建或擬建住宅建築物的安全、保安及良好管理是必要的；
- (ii) 除了用作全職及有必要聘用於該地段的看更或看守員或兩者的辦公設施之外，該等設施不得用作任何其他用途；及
- (iii) 該等設施的位置須先經署長的書面批准。」

### 24. 看更和看守員的宿舍

批地文件特別條件第(49)(a)條規定：

- 「(a) 倘若該地段或其任何部分用作住宅用途，則可在該地段內提供看更或看守員或兩者的宿舍，但須受下列條件規限：
- (i) 該宿舍須設置在該地段已建的其中一幢住宅大樓內或署長以書面批准的其他位置；及
- (ii) 該宿舍須設有獨立洗手間、淋浴、盥洗及廚房設施；及
- (iii) 除了用作全職及有必要聘用於該地段的看更或看守員或兩者的住宿處所之外，該宿舍不得用作任何其他用途。」

### 25. 業主立案法團/ 業主委員會辦事處

批地文件特別條件第(50)(a)條規定：

- 「(a) 倘若該地段或其任何部分用作住宅用途，則可在該地段內設立一個辦事處供業主立案法團或業主委員會之用，惟：
- (i) 除了用作已經或將會就該地段及其上已建或擬建建築物組成的業主立案法團或業主委員會進行會議及行政工作之外，該辦事處不得用作任何其他用途；及
- (ii) 該辦事處的位置須先經署長書面批准。」

### 26. 泊車規定

批地文件特別條件第(51)條規定：

- 「(a) 須在該地段內按以下比率提供停泊汽車的車位，達至署長滿意程度：
- (i) 為該地段已建或擬建建築物的每九個住宅單位(或不足九個則其部分)設五個車位，但車位總數不得超過435(下稱「住宅車位」)；
- (ii) 為每幢住宅大樓設五個車位；及
- (iii) 為該地段已建或擬建非工業(不包括住宅、辦公室、酒店及加油站)用途的建築物的每200平方米(或不足200平方米則其部分)建築面積，設一個車位。

就計算以上第(a)(iii)款提供的車位數目而言，用於泊車及上落貨用途的任何樓面面積不計算在內。

- (b) 如此提供的每一車位所佔面積為2.5米闊乘5.0米長，淨高最少2.4米，但如任何上述車位用於停泊《道路交通條例》、根據該條例制定的任何規例及任何修訂立法定義的傷殘人士之汽車，其尺寸大小須為署長書面批准者。
- (c) (i) 按照本特別條件(a)(i)及(a)(iii)款提供的車位，除了用作停泊《道路交通條例》、根據該條例制定的任何規例及任何修訂立法之下獲發牌並屬於該地段已建或擬建建築物的住戶或佔用人及其真正客人、訪客或受邀人的汽車之外，不得用作任何其他用途，尤其是所述車位不得用於儲存、展示或展覽汽車以供出售或其他用途。



- (ii) 按照本特別條件(a)(ii)款提供的車位，除了用作停泊《道路交通條例》、根據該條例制定的任何規例及任何修訂立法之下獲發牌並屬於該地段已建或擬建建築物的真正訪客或受邀人的汽車之外，不得用作任何其他用途，尤其是所述車位不得用於儲存、展示或展覽汽車以供出售或其他用途。該等車位構成本批地文件的特別條件第(11)(a)(v)條定義的公用地方之一部分。」

### 27. 電單車車位

批地文件特別條件第(52)條規定：

- 「(a) 須在該地段內按不少於5%而不多於10%的按照本批地文件特別條件第(51)(a)(i)條計算的住宅車位數目之比率提供停泊電單車的車位(下稱「電單車車位」)，達至署長滿意程度。
- (b) 提供的每一電單車車位所佔面積為1.0米闊乘2.4米長，淨高最少2.3米。除了用作停泊《道路交通條例》、根據該條例制定的任何規例及任何修訂立法之下獲發牌並屬於該地段已建或擬建建築物的住戶或佔用人及其真正客人、訪客或受邀人的電單車之外，該等車位不得用作任何其他用途，尤其是所述車位不得用於儲存、展示或展覽汽車以供出售或其他用途。」

### 28. 上落貨規定

批地文件特別條件第(53)條規定：

- 「(a) 須在該地段內按以下比率提供貨車上落貨車位，達至署長滿意程度：
  - (i) 為該地段已建或擬建的每幢住宅大樓設一個車位，該上落貨車位設於該地段已建或擬建的每幢住宅大樓毗鄰或之內；(就本(a)(i)款而言，擬用作為單一家庭住宅的獨立屋、半獨立屋或排屋不被視為一幢住宅大樓)；
  - (ii) 為該地段已建或擬建的非工業(不包括住宅、辦公室、酒店及加油站)用途的建築物的每1,200平方米(或不足1,200平方米則其部分)建築面積，設一個車位；

如此提供的車位的尺寸為3.5米闊，11.0米長，淨高最少4.1米。除了供貨車就上述建築物進行上落貨之外，該等車位不得用作任何其他用途。

就計算本特別條件第(a)(ii)款之下提供的車位數目而言，用於泊車及上落貨用途的任何樓面面積不計算在內。

- (b) 須在該地段內提供一個垃圾車裝卸車位，達至署長滿意程度。提供的車位的最起碼尺寸為12.0米長，5.0米闊，淨高最少4.5米，而且除了供垃圾車進行裝卸之外，不得用作任何其他用途。提供的車位的位置須為車輛無須從毗連該地段的道路倒車進入該地段，亦無須從該地段倒車離開至毗連的道路。」

### 29. 轉讓住宅車位的限制

批地文件特別條件第(56)(a)及(b)條規定：

- 「(a) 按照本批地文件的特別條件第(51)條在該地段內提供的住宅車位，除了用作停泊屬於該地段已建或擬建建築物的住宅單位住戶之汽車之外，不得用作任何其他用途，並須於本批地文件的特別條件第(58)條所述的經批准停車場平面圖上指定為用作該用途。
- (b) 住宅車位不得：
  - (i) 轉讓，除非：

- (I) 連同該地段的不分割份數和該地段已建或擬建建築物住宅單位的獨家使用及管有權一起轉讓；或
- (II) 轉讓予已擁有該地段的不分割份數並享有該地段已建或擬建建築物住宅單位的獨家使用及管有權的人士；或

(ii) 分租，除非分租予該地段已建或擬建建築物住宅單位的住戶。」

### 30. 垃圾房

批地文件特別條件第(57)條規定：

「買方須自費在該地段內提供並維修保養綜合的垃圾收集系統之設施，達至食物環境衛生署署長滿意。」

### 31. 天然地勢/登記一份顯示山泥傾瀉危害研究區位置、性質及範圍的圖則

批地文件特別條件第(60)條規定：

- 「(a) (i) 買方承認因天然地勢的性質，該地段可能受來自該地段以西地方(下稱「山泥傾瀉危害研究區」)的山泥傾瀉(包括巨石下墜)影響。山泥傾瀉研究區的位置、性質及範圍由土木工程拓展署署長決定，其決定為終論並對買方有約束力。買方須在2008年12月31日或之前自費就該等危害在該地段及山泥傾瀉研究區內進行及完成土力勘察(下稱「該勘察」)，達至署長滿意程度。未經署長事先書面同意，不得在山泥傾瀉研究區以外的任何政府土地進行任何土地勘測。
- (ii) 須於土地註冊處就該地段妥為登記一份經由土木工程拓展署署長批准的顯示山泥傾瀉危害研究區的位置、性質及範圍的圖則。任何影響該地段或其任何部分或該地段已建或擬建建築物或其部分的交易(但本批地文件的特別條件第(9)(c)條允許的租賃或租約，或租賃或租約的協議，或本批地文件的特別條件第(9)(d)條之下的建築按揭，或署長批准的其他交易除外)，在上述登記的一個曆月之後方可訂立。
- (b) 完成該勘察後，買方須自費於該地段內進行署長按其絕對酌情權要求的任何必要的緩解及鞏固工程(下稱「該等工程」)，以保護該地段或其任何部分的已建或擬建建築物，及其內之任何住戶或佔用人及其真正客人、訪客或受邀人免於來自山泥傾瀉危害研究區的山泥傾瀉危害，包括巨石下墜。
- (c) 如政府或買方或兩者均認為有必要於任何政府土地(包括山泥傾瀉研究區)進行緩解及鞏固工程(下稱「外區工程」)(須於其上進行或須就其進行外區工程的任何政府土地下稱「外區」)，買方須於收到署長就進行外區工程的批准或要求後，自費進行及完成外區工程以達至署長滿意程度。買方須自費於土地註冊處就該地段註冊一份獲署長接納的顯示外區及外區工程的位置、性質及範圍的圖則。
- (d) 買方須於本批地文件同意授予的年期內一切時候自費維修保養該等工程、外區工程及外區處於修葺良好堅固的狀況，達至署長滿意程度，以確保該等工程及外區工程持續運作。若買方違反本條規定的關於維修保養該等工程、外區工程及外區的義務，政府除就該等違反情況而享有的任何權利或補救方法之外，署長可透過書面通知方式要求買方進行署長按其絕對酌情權認為適當的維修保養工程。如買方忽視或未能在該通知指定的期限內遵從該項通知的要求以達至署長滿意程度，署長可立即執行及進行必要的維修保養工程，而買方須按要求向政府償付該費用，連同任何行政和專業費用及收費。
- (e) 該勘察、該等工程及外區工程須在各方面遵守《建築物條例》、根據該條例制定的任何規例、任何修訂立法以及任何其他有關的政府立法。

# SUMMARY OF LAND GRANT

## 批地文件的摘要

- (f) 僅就進行該勘察、該等工程及外區工程和檢查及維修保養該等工程、外區工程及外區而言，買方有權進出外區，惟須受署長按其獨自酌情權施加的條款及條件之制約。
- (g) 如由於按照本特別條件的條款正在進行或已經進行的任何工程，導致或引起任何政府土地（包括外區）或該地段範圍外任何土地受到任何損害，買方須自費修復該等損害並於各方面達至署長滿意程度。
- (h) 對於按照本特別條件的條款正在進行或已經進行的任何工程，或買方遺漏、忽視或沒有進行任何該工程，或來自外區的任何山泥傾瀉危害（包括巨石下墜），包括但不限於對財產及人命造成的任何損害或損失或人身傷害，或對與外區毗連或在外區之內的墳墓造成的任何干擾或損害，因而引起或附帶的一切訴訟、法律程序、責任、索償、費用和要求，買方特此向政府作出彌償並保持政府獲得彌償。」

備註：

1. 以上提及的“綠色間黑斜線顯示的範圍”及“粉紅色間黑斜線顯示的範圍”之位置於本售樓說明書AR節中以圖則顯示。
2. 如欲知悉全部詳情，請參閱批地文件。完整的批地文件現存於售樓處，於開放時間可按要求供免費查閱。在支付所需影印費後，亦可取得批地文件之複印本。

# INFORMATION ON PUBLIC FACILITIES AND PUBLIC OPEN SPACES

## 公共設施及公眾休憩用地的資料

### A. Facilities that are required under the land grant to be constructed and provided for the Government, or for public use

1. Description
  - (a) The Green Hatched Black Areas as referred to in Special Condition No.(23)(a) of the Land Grant;
  - (b) The Drainage Reserve and the Structures as referred to in Special Condition No.(28)(a)(i) and (ii) of the Land Grant;
  - (c) The Landslip Hazards Study Areas and the Outside Areas as referred to in Special Condition No.(60)(a)(i) and (c) of the Land Grant.

### B. Facilities that is required under the land grant to be managed, operated or maintained for public use at the expense of the owners of the residential properties in the Development

2. Not applicable.

### C. Open space that is required under the land grant to be managed, operated or maintained for public use at the expense of the owners of the residential properties in the Development

3. Not applicable.

### D. Any part of the land (on which the Development is situated) that is dedicated to the public for the purposes of section 22(1) of the Building (Planning) Regulations (Cap. 123 sub. Leg. F)

4. Not applicable.

### E. A plan that shows the location of those facilities and open spaces, and those parts of the land

The plan(s) is/are reproduced at the end of this section.

### F. Provisions of the land grant that concern those facilities and open spaces, and those parts of the land

5. Special Condition No.(23) of the Land Grant stipulates that:-

“(23)(a) The Purchaser shall at his own expense carry out and complete to the satisfaction of the Director such geotechnical investigations and such slope treatment, landslide preventive, mitigation and remedial works on the areas shown coloured green hatched black on the plan marked “PLAN A” annexed hereto (hereinafter referred to as “the Green Hatched Black Areas”) as the Director in his absolute discretion may require and shall, at all times during the term hereby agreed to be granted, at his own expense, maintain in good and substantial repair and condition to the satisfaction of the Director the Green Hatched Black Areas including all land, slope treatment works, earth-retaining structures, drainage and any other works therein and thereon. In the event that any landslip, subsidence or falling away occurs within the Green Hatched Black Areas at any time during the term hereby agreed to be granted, the Purchaser shall at his own expense reinstate and make good the same to the satisfaction of the Director together with any adjacent or adjoining areas which, in the opinion of the Director (whose decision shall be final and binding on the Purchaser), have also been affected. The Purchaser shall indemnify the Government, its agents and contractors against all claims, proceedings, costs, damages and expenses whatsoever incurred by reason of such landslip, subsidence or falling away. The Purchaser shall ensure at all times that there shall be no illegal excavation or dumping on the Green Hatched Black Areas and, subject to the prior written approval of the Director, the Purchaser may erect fences or other barriers for the prevention of such illegal excavation or dumping. In addition to any other rights or remedies the Director may have in respect of any breach of these Conditions, the Director may at any time by notice in writing call upon the Purchaser to carry out such geotechnical investigations, slope treatment, landslide preventive, mitigation and remedial works and to maintain, reinstate and make good any land, structure or works affected by such landslip, subsidence or falling away, and if the Purchaser shall neglect or fail to comply with such notice to the satisfaction of the Director within the period specified therein, the Director may, after the expiry of such period, execute and carry out the required works and the Purchaser shall on demand repay to the Government the cost thereof.

- (b) Notwithstanding sub-clause (a) of this Special Condition, the obligations and rights of the Purchaser in respect of the Green Hatched Black Areas or any part thereof under this Special Condition shall absolutely determine upon the Government giving to the Purchaser notice to that effect, and no claim for compensation shall be made against the Government or the Director or his authorized officer by the Purchaser in respect of any loss, damage or disturbance suffered or any expense incurred as a result of such determination. However, such determination shall be without prejudice to any rights or remedies of the Government in respect of any antecedent breach, non-performance or non-observance of the said sub-clause (a).”

# INFORMATION ON PUBLIC FACILITIES AND PUBLIC OPEN SPACES

## 公共設施及公眾休憩用地的資料

### 6. Special Condition No.(28) of the Land Grant stipulates that:-

“(28) (a) The Purchaser shall:

- (i) on or before the 31st day of December 2010, at his own expense and in all respects to the satisfaction of the Director, form, construct and surface the area shown coloured pink hatched black on the plan marked “PLAN A” annexed hereto (hereinafter referred to as “the Drainage Reserve”);
  - (ii) on or before the 31st day of December 2010, at his own expense and in all respects to the satisfaction of the Director, provide, lay and construct such sewers and drains, culverts, manholes with covers, access and other structures (hereinafter collectively referred to as “the Structures”) for and in connection with the formation, construction and surfacing of the Drainage Reserve as the Director at his sole discretion may require, in such manner, at such levels, with such materials and to such standards, specifications and design as may be approved by the Director; and
  - (iii) maintain at his own expense and in all respects to the satisfaction of the Director, the Structures in good condition until a letter from the Director indicating that these Conditions have been complied with to his satisfaction has been issued.
- (b) (i) No building or structure or support for any building or structure except the Structures shall be erected or constructed within the Drainage Reserve.
- (ii) Notwithstanding sub-clause (b)(i) of this Special Condition, with the prior written consent of the Director and subject to such terms and conditions as he may impose, the Purchaser may erect or permit to be erected on the Drainage Reserve:
- (I) a minor structure or structures such as boundary walls and fences provided that if and when required by the Director, the Purchaser shall at his own expense, within the period specified by and in all respects to the satisfaction of the Director, remove or demolish such structure or structures and reinstate the Drainage Reserve; and
  - (II) a structure or structures provided that there is a clear space extending upwards from ground level on or over the Drainage Reserve to a height of 5.10 metres. For the purpose of this Special Condition, the decision of the Director as to what constitutes the ground level, and the required height above it, shall be final and binding upon the Purchaser.
- (iii) If the Purchaser fails to carry out such removal demolition or reinstatement works referred to in sub-clause (b)(ii)(I) of this Special Condition within the period specified or as required in an emergency, the Director may carry out such works as he may consider necessary and the Purchaser shall pay to the Government on demand the cost of such works.

- (c) The Director and his duly authorized officers, contractors, his or their workmen (hereinafter collectively referred to as “the said authorized persons”) with or without tools, equipment, machinery or motor vehicles shall have the right of unrestricted ingress, egress and regress at all times to, from and through the lot or any part thereof for the purposes of laying, inspecting, repairing, maintaining or renewing drains, sewers, channels, drainage facilities and all other services running across, through or under the Drainage Reserve (hereinafter referred to as “the Utilities”) and the Structures which the Director may require or authorize. No object or material of whatsoever nature which may obstruct access or cause excessive surcharge to the Utilities or the Structures shall be placed within the Drainage Reserve. Where in the opinion of the Director (whose opinion shall be final and binding on the Purchaser), there are objects or material within the Drainage Reserve which may obstruct access or cause excessive surcharge to the Utilities or the Structures, the Director shall be entitled by notice in writing to call upon the Purchaser, at his own expense and in all respects to the satisfaction of the Director, to demolish or remove such objects or material and to reinstate the Drainage Reserve. If the Purchaser shall neglect or fail to comply with such notice within the period specified therein, or as required in an emergency the Director may carry out such removal demolition and reinstatement works as he may consider necessary and the Purchaser shall pay to the Government on demand the cost of such works.
- (d) Save in respect of the reinstatement of any trench excavated in the exercise of the aforesaid rights and powers, the Government and the said authorized persons shall have no liability in respect of any loss, damage, nuisance or disturbance whatsoever caused to or suffered by the Purchaser arising out of or incidental to the exercise by the said authorized persons of the right of unrestricted ingress, egress and regress and in laying, inspecting, repairing, maintaining and renewing the Utilities and the Structures conferred under sub-clause (c) of this Special Condition, and no claim shall be made against the Government or the said authorized persons by the Purchaser in respect of any such loss, damage, nuisance or disturbance.”

### 7. Special Condition No.(60) of the Land Grant stipulates that:-

- “(60) (a) (i) The Purchaser hereby acknowledges that the lot may be affected by landslip hazards including boulder falls arising from the areas to the west of the lot (hereinafter referred to as “the Landslip Hazards Study Areas”) due to the nature of the natural terrain. The location, nature and extent of the Landslip Hazards Study Areas shall be decided by the Director of Civil Engineering and Development whose decision shall be final and binding on the Purchaser. The Purchaser shall on or before the 31st day of December 2008, at his own expense carry out and complete to the satisfaction of the Director geotechnical investigation (hereinafter referred to as “the Investigation”) within the lot and on the Landslip Hazards Study Areas for such hazards. No ground investigation shall be carried out on any Government land outside the Landslip Hazards Study Areas without the prior written consent of the Director.
- (ii) A plan approved by the Director of Civil Engineering and Development indicating the location, nature and extent of the Landslip Hazards Study Areas shall be duly registered in the Land Registry against the lot. No transaction (except a tenancy or lease or an agreement for a tenancy or lease permitted by Special Condition No. (9)(c) hereof, a building mortgage under Special Condition No. (9)(d) hereof or such other transactions as the Director may approve) affecting the lot or any part thereof or any building or part of any building erected or to be erected on the lot shall be entered into until after one calendar month from such registration.
- (b) On completion of the Investigation, the Purchaser shall at his own expense carry out any necessary mitigation and stabilisation works within the lot as the Director in his absolute discretion shall require (hereinafter referred to as “the Works”) to protect any building or buildings erected or to be erected on the lot or any part thereof and any residents or occupiers therein and their bona fide guests, visitors and invitees from landslip hazards including boulder falls arising from the Landslip Hazards Study Areas.

- (c) Where it is deemed necessary by the Government or the Purchaser or both to carry out mitigation and stabilisation works (hereinafter referred to as “the Outside Works”) on any Government land including the Landslip Hazards Study Areas (any Government land on or in relation to which the Outside Works are carried out are hereinafter referred to as “the Outside Areas”), the Purchaser shall, upon receipt of the Director’s approval to or request for the Outside Works, at his own expense carry out and complete the Outside Works to the satisfaction of the Director. The Purchaser shall register at his own expense in the Land Registry against the lot a record plan accepted by the Director indicating the location, nature and extent of the Outside Areas and the Outside Works.
- (d) The Purchaser shall at all times during the term hereby agreed to be granted, maintain at his own expense the Works, the Outside Works and the Outside Areas in good substantial repair and conditions to the satisfaction of the Director to ensure the continuing functioning of the Works and the Outside Works. In addition to any rights or remedies the Government may have against the Purchaser for breach of the Purchaser’s obligations to maintain the Works, the Outside Works and the Outside Areas as herein provided, the Director shall be entitled by notice in writing to call upon the Purchaser to carry out such maintenance works as the Director shall in his absolute discretion deem fit. If the Purchaser shall neglect or fail to comply with such notice to the satisfaction of the Director within the period specified therein, the Director may forthwith execute and carry out the required maintenance works and the Purchaser shall on demand repay the Government the cost thereof, together with any administrative and professional fees and charges.
- (e) The Investigation, the Works and the Outside Works shall in all respects comply with the Buildings Ordinance, any regulations made thereunder, any amending legislation and any other relevant Government legislation.
- (f) For the purpose only of carrying out the Investigation, the Works and the Outside Works and inspecting and maintaining the Works, the Outside Works and the Outside Areas, the Purchaser shall have the right of ingress or egress to and from the Outside Areas subject to such terms and conditions as may be imposed by the Director at his sole discretion.
- (g) In the event that as a result of or arising out of any works being carried out or having been carried out pursuant to the terms of this Special Condition any damage is done to any Government land including the Outside Areas or any land outside the lot, the Purchaser shall make good such damage at his own expense and in all respects to the satisfaction of the Director.
- (h) The Purchaser hereby indemnifies and shall keep indemnified the Government from and against all actions, proceedings, liabilities, claims, costs and demands whatsoever arising out or incidental to any works being carried out or having been carried out pursuant to the terms of this Special Condition or the omission, neglect or default by the Purchaser to carry out any such works or any landslip hazard including boulder falls from the Outside Areas including but without limitation to any damage to or loss of properties and life or personal injuries or any interference or damage to the graves adjoining or within the Outside Areas.”

### G. Provisions of every deed of mutual covenant in respect of the specified residential property that concern those facilities and open spaces, and those parts of the land

8. Section 2(1) of the Deed of Mutual Covenant and Management Agreement (“DMC”) stipulates that:-

“In this Deed the following expressions shall have the following meanings except where the context otherwise permits or requires:-

“Green Hatched Black Areas”

means the areas shown coloured green hatched black on Plan A annexed to the Conditions including such works thereon (including land, slope treatment works, earth-retaining structures, drainage and any other works therein and thereon) completed in accordance with Special Condition No.(23) of the Conditions;

“Landslip Hazards Study Areas”

means such portion of area shown on the plan registered in the Land Registry by Memorial No. 09082702750070 pursuant to Special Condition No. (60)(a)(ii) of the Conditions;

“Maintenance Manual for the Works and Outside Works”

means the maintenance manual for the Works and Outside Works, a copy of which shall be kept at the management office and may be inspected by the Owners free of charge during the normal office hours of the Manager;

“Outside Areas”

means any Government land outside the Lot including the Landslip Hazards Study Areas as more particularly defined in the Conditions and on or in relation to which Outside Works are required to be done where necessary in accordance with Special Condition No.(60)(c) of the Conditions;

“Outside Works”

means all mitigation and stabilization works in the Outside Areas where it is deemed necessary in accordance with Special Condition No.(60)(c) of the Conditions and which are required to be maintained to the satisfaction of the Director of Lands;

“Works”

means all necessary mitigation and stabilization works within the Lot to protect the Development and any part thereof and any residents or occupiers and their bona fide guests, visitors and invitees therein from landslip hazards including boulder falls arising from the Landslip Hazards Study Areas as required by the Conditions or this Deed to be maintained by the Owners;”

9. Clause 14(a)(xv) of the DMC stipulates that:-

“The Manager shall prepare the annual budget for the ensuing year in consultation with the Owners’ Committee (if any) except the first budget which shall cover the period from the date of this Deed until the following 31st day of December. The annual budget shall be in two parts :-

- (a) The first part shall cover all expenditure which in the opinion of the Manager (whose decision shall be conclusive save for manifest error) is to be expended for the benefit of all Owners or required for the proper management of the Development and the Development Common Areas and Facilities therein including but without prejudice to the generality of the foregoing :-

...

# INFORMATION ON PUBLIC FACILITIES AND PUBLIC OPEN SPACES

## 公共設施及公眾休憩用地的資料

(xv) the cost and expense of inspecting maintaining reinstating repairing and carrying out the Works (if any), Outside Works (if any), foundations, columns and other structures constructed or to be constructed and reinstating and making good the same in the event of any landslip, subsidence or falling away and the drains nullahs sewers pipes watermains and channels and such other areas whether within or outside the Lot or that are required to be maintained under the Conditions or for the proper functioning of the Development;  
...”

10. Clauses 36(ab), (az) and (ba) of the DMC stipulates that:-

“The management of the Lot and the Development shall be undertaken by the Manager for an initial period of not exceeding two (2) years and shall continue until terminated as provided under Clause 10 of this Deed and each Owner hereby irrevocably APPOINTS the Manager as agent for all Owners in respect of any matter concerning the Common Areas and Facilities duly authorised in accordance with the provisions of this Deed and to enforce and carry into effect all provisions of this Deed subject to the Building Management Ordinance (Cap.344). In addition to the other powers expressly provided in this Deed, the Manager shall have authority to do all such acts and things as may be necessary or expedient for or in connection with the Lot and the Development and the management thereof including in particular but without in any way limiting the generality of the foregoing :-

...

(ab) To have the sole right to represent all the Owners in all matters and dealings with the Government or any statutory body or any utility or other competent authority or any other person whomsoever in any way touching or concerning the Lot and the Development as a whole or the Common Areas and Facilities or the Green Hatched Black Areas, the Landslip Hazards Study Areas and the Outside Areas with power to bind all Owners as to any policy adopted or decision reached or action taken in relation to any such dealings;

...

(az) To engage qualified personnel to carry out, complete, maintain and ensure the continuing functioning of the Works within the Lot in compliance with the Conditions, Buildings Ordinance, any regulations made thereunder, any amending legislation and any other relevant Government legislation and/or in accordance with all guidelines issued from time to time by the appropriate Government department regarding the Works and to collect from the Owners all costs lawfully incurred or to be incurred by the Manager in carrying out such works and maintenance Provided that the Manager shall not be made personally liable for carrying out any such requirements of the Conditions and/or guidelines aforesaid which shall remain the responsibility of the Owners if, having used all reasonable endeavours, the Manager is unable to collect the costs of the required works from all Owners pursuant to the terms of this Deed;

(ba) To engage qualified personnel to carry out, complete, maintain and ensure the continuing functioning of the Outside Works in the Outside Areas in compliance with the Conditions, Buildings Ordinance, any regulations made thereunder, any amending legislation and any other relevant Government legislation and/or in accordance with all guidelines issued from time to time by the appropriate Government department regarding the Outside Works and to collect from the Owners all costs lawfully incurred or to be incurred by the Manager in carrying out such works and maintenance Provided that the Manager shall not be made personally liable for carrying out any such requirements of the Conditions and/or guidelines aforesaid which shall remain the responsibility of the Owners if, having used all reasonable endeavours, the Manager is unable to collect the costs of the required works from all Owners pursuant to the terms of this Deed;

...”

11. Clause 37 of the Third Schedule of the DMC stipulates that:-

“(a) The Owners shall at their own expense in the proportion of the number of Management Shares allotted to their respective Units maintain the Works, the Outside Works and the Outside Areas in good substantial repair and conditions and to carry out such works thereon and thereto to the satisfaction of the Director of Lands and in observance and compliance with Special Conditions No.(60) and any other provisions of the Conditions and the Maintenance Manual for the Works and Outside Works.

(b) The First Owner shall deposit a full set of the Maintenance Manual for the Works and Outside Works at the management office within one month from the date of this Deed. The Maintenance Manual for the Works and Outside Works shall be available for inspection by the Owners free of charge during the normal office hours of the Manager and the taking of copies by the Owners upon request on payment of reasonable copying charges. All charges received shall be credited to the Special Fund.”

# INFORMATION ON PUBLIC FACILITIES AND PUBLIC OPEN SPACES

## 公共設施及公眾休憩用地的資料

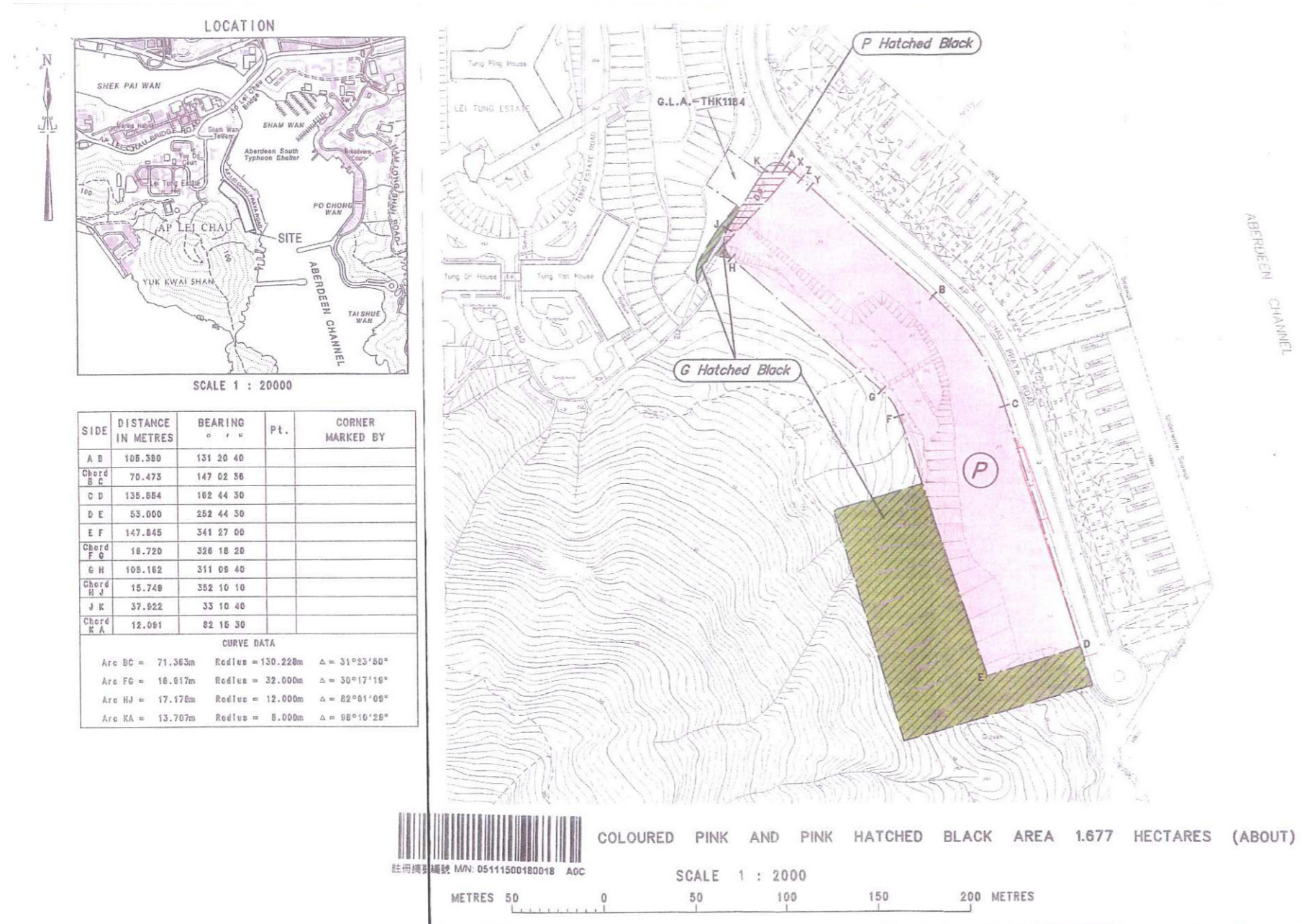

PINK HATCHED BLACK  
GREEN HATCHED BLACK

MODIFICATION LETTER REFERS  
X Y Z

Note:  
The plan is extracted from the plan annexed to the Land Grant for indication of the Green Hatched Black Area and Pink Hatched Black Area (Drainage Reserve).

# INFORMATION ON PUBLIC FACILITIES AND PUBLIC OPEN SPACES

## 公共設施及公眾休憩用地的資料

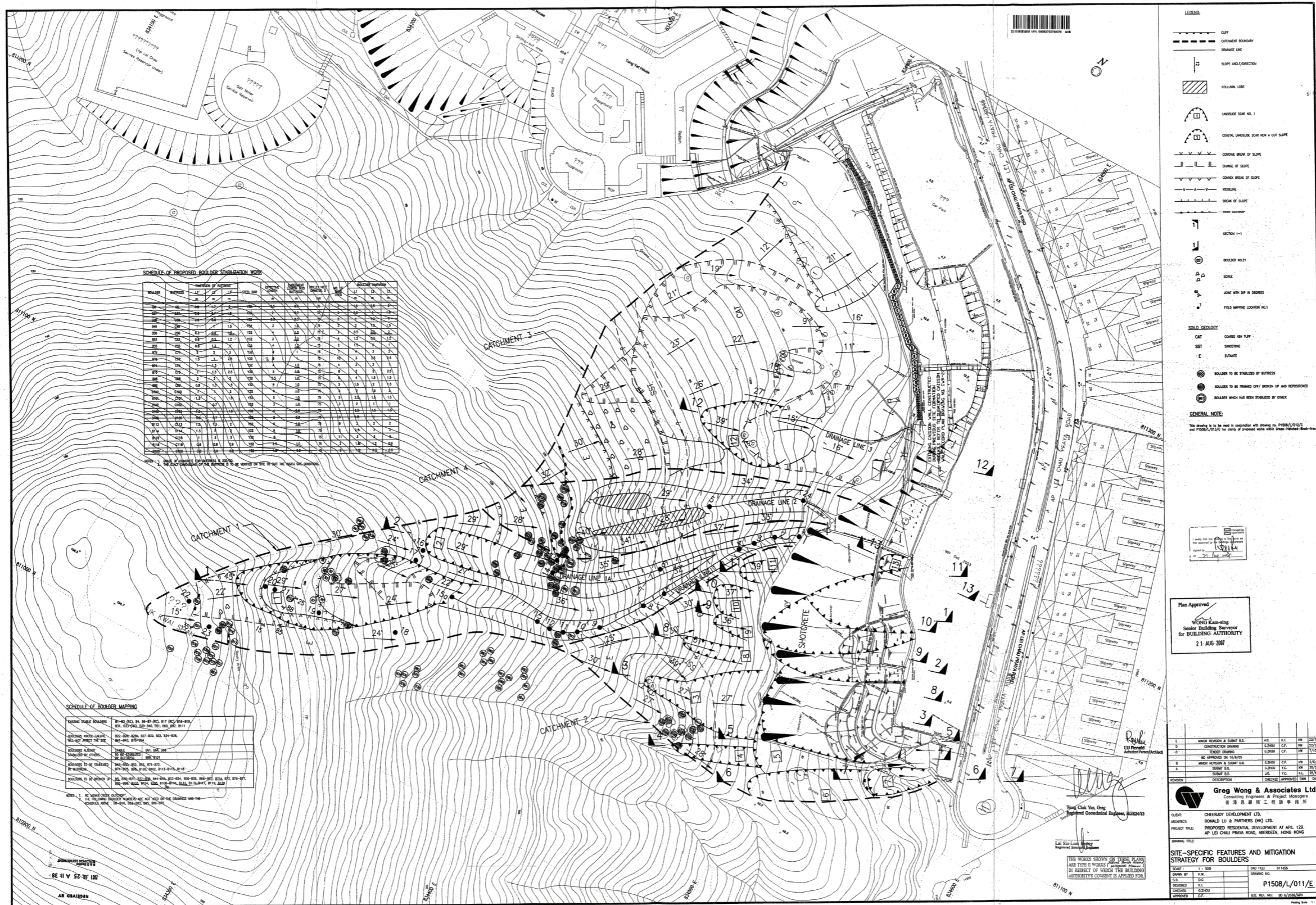

Note:  
This plan is extracted from the plan registered in the Land Registry by Memorial No. 09082702750070 for indication of the Landslip Hazards Study Area.



### A. 根據批地文件規定須興建並提供予政府或供公眾使用的設施

#### 1. 描述

- (a) 批地文件特別條件第(23)(a)條所述的綠色間黑斜線範圍；
- (b) 批地文件特別條件第(28)(a)(i)及(ii)條所述的渠務預留區域和該等構築物；
- (c) 批地文件特別條件第(60)(a)(i)及(c)條所述的山泥傾瀉危害研究區和外區。

### B. 根據批地文件規定須由發展項目中的住宅物業的擁有人出資管理、營運或維持以供公眾使用的任何設施

#### 2. 不適用。

### C. 根據批地文件規定須由發展項目中的住宅物業的擁有人出資管理、營運或維持以供公眾使用的休憩用地

#### 3. 不適用。

### D. 發展項目所位於的土地中為施行《建築物(規劃)規例》(第123章, 附屬法例F)第22(1)條而撥供公眾用途的任何部分

#### 4. 不適用。

### E. 顯示該等設施、休憩用地及土地中的該等部分的位置之圖則

該(等)圖則於本部分之末提供。

### F. 批地文件中關於該等設施、休憩用地及土地中的該等部分的條文

#### 5. 批地文件特別條件第(23)條規定：

「(23)(a) 買方須在隨附於本批地文件標明為「圖則A」的圖則上綠色間黑斜線顯示的範圍(下稱「綠色間黑斜線範圍」)，自費進行與完成署長按其絕對酌情權要求的土力勘察、斜坡處理、山泥傾瀉之防止、緩解及補救工程，達至署長滿意程度；並且在本批地文件同意授予的年期內一切時候自費維修保養綠色間黑斜線範圍，包括該範圍之內及之上的一切土地、斜坡處理工程、護土構築物、排水渠及任何其他工程，處於修葺良好堅固的狀況，達至署長滿意程度。如於本批地文件同意授予的年期內任何時候，綠色間黑斜線範圍內發生任何山泥傾瀉、地陷或塌方，買方須自費復原及修復該範圍以及署長認為(其決定為終論並對買方有約束力)亦受影響的任何相鄰或毗連範圍，達至署長滿意程度。對於因上述山泥傾瀉、地陷或塌方而招致的所有索償、法律程序、費用、須付損害賠償及開支，買方須向政府、其代理人及承判商作出彌償。買方須確保在一切時候綠色間黑斜線範圍之上沒有非法挖掘或傾倒之情況。在取得署長事先書面批准的前提下，買方可豎設圍牆或其他障礙物以防止出現上述非法挖掘或傾倒情況。若有違反批地條件的情況發生，署長除就該等違反情況而享有任何其他權利或補救方法之外，可於任何時候以書面通知方式要求買方進行上述土力勘察、斜坡處理、山泥傾瀉之防止、緩解及補救工程，並維修保養、復原及修復受上述山泥傾瀉、地陷或塌方影響的任何土地、構築物或工程。如買方忽視或未能在該通知指定的期限內遵從該通知的要求以達至署長滿意程度，署長可於該期限屆滿後執行及進行必要工程，而買方須按要求向政府償付該費用。」

(b) 儘管有本特別條件(a)款的規定，但買方在本特別條件之下就綠色間黑斜線範圍或其任何部分而有的義務和權利將於政府向買方發出相關通知時完全終止，而買方不得就該項終止導致其遭受的任何損失、損害或干擾或招致的任何開支向政府或署長或其授權人員提出索償。然而，該項終止並不影響政府因買方對上述(a)款的任何先前違反、不履行或不遵守情況而享有的任何權利或補救方法。」

#### 6. 批地文件特別條件第(28)條規定：

「(28)(a) 買方須：

- (i) 在2010年12月31日或之前，自費構建、建造隨附於本批地文件標明為「圖則A」的圖則上粉紅色間黑斜線顯示的範圍(下稱「渠務預留區域」)並平整該範圍的表面，在各方面達至署長滿意程度；
- (ii) 在2010年12月31日或之前，自費就渠務預留區域的構建、建造及表面平整提供、鋪設及建造署長按其獨自酌情權要求的污水渠及排水渠、暗渠、連蓋沙井、通道及其他構築物(以下合稱「該等構築物」)，其方式、水平、材料、標準、規格及設計須為署長批准者，且須在各方面達至署長滿意程度；及
- (iii) 自費維修保養該等構築物處於良好狀態以在各方面達至署長滿意程度，直至署長發函表示批地條件已獲遵守致使其滿意為止。

(b) (i) 除該等構築物外，不得在渠務預留區域內興建或建造建築物、構築物，或支撐任何建築物或構築物的結構。

(ii) 儘管有本特別條件(b)(i)款的規定，但如取得署長事先書面同意並在遵守其施加的條款及條件的前提下，買方可在渠務預留區域內興建或容許他人興建：

(I) 小型構築物，例如邊界牆壁及圍牆，但如署長要求時，買方須自費在署長指明的期限內清除或拆卸該構築物和復原渠務預留區域，以在各方面達至署長滿意程度；及

(II) 構築物，條件是由渠務預留區域地面向上起計的淨空間須有5.10米。就本特別條件而言，署長對於何謂地面和對地面之上所需高度作出的決定為終論並對買方有約束力。

(iii) 倘若買方未能在指定期限內或未能按緊急情況所需進行本特別條件第(b)(ii)(I)款所述的清除、拆卸或復原工程，署長可展開其認為必須的工程，而買方須按要求向政府償付該等工程的費用。

(c) 署長、獲其正式授權的人員、承判商或他們的工人(以下合稱「獲授權的人士」)，不論有否帶同工具、設備、機器或汽車，在一切時候均具有不受限制來回進出及通過該地段或其任何部分的權利，旨在鋪設、檢查、修理、維修保養或翻新署長要求或批准的經過、貫穿或藏於渠務預留區域和該等構築物之下的排水渠、污水渠、渠道、排水設施及一切其他服務(下稱「公用事業設施」)。任何性質的物體或物料，若其可能引起防礙進入或使用公用事業設施或該等構築物或引致其超出荷載，均不得放置於渠務預留區域之內。凡署長認為(其意見為終論並對買方有約束力)渠務預留區域內有物體或物料可能引起防礙進入或使用公用事業設施或該等構築物或引致其超出荷載，署長有權給予買方書面通知要求買方自資拆卸或清除該物體或物料，並復原渠務預留區域，在各方面達至署長滿意程度。如買方忽視或未能於通知指明期限內或緊急情況所需時遵從該項通知，則署長可進行其認為必需的清除、拆卸及復原工程，而買方須按要求向政府償付該等工程的費用。」

# INFORMATION ON PUBLIC FACILITIES AND PUBLIC OPEN SPACES

## 公共設施及公眾休憩用地的資料

- (d) 除須將任何因行使上述權利及權力而挖掘的壕溝復原外，對由於獲授權的人士根據本特別條件第(c)款行使不受限制的進出權並且鋪設、檢查、修理、維修保養及翻新公用事業設施及該等構築物而引致或附帶使買方遭受或蒙受的任何損失、損害或干擾，政府及獲授權的人士一概不須負責。買方亦不得向政府或獲授權的人士提出有關任何該等損失、損害、滋擾或干擾的索償。」

### 7. 批地文件特別條件第(60)條規定：

- 「(60)(a) (i) 買方承認因天然地勢的性質，該地段可能受來自該地段以西地方(下稱「山泥傾瀉危害研究區」)的山泥傾瀉(包括巨石下墜)影響。山泥傾瀉研究區的位置、性質及範圍由土木工程拓展署署長決定，其決定為終論並對買方有約束力。買方須在2008年12月31日或之前自費就該等危害在該地段及山泥傾瀉研究區內進行及完成土力勘察(下稱「該勘察」)，達至署長滿意程度。未經署長事先書面同意，不得在山泥傾瀉研究區以外的任何政府土地進行任何土地勘測。
- (ii) 須於土地註冊處就該地段妥為登記一份經由土木工程拓展署署長批准的顯示山泥傾瀉危害研究區的位置、性質及範圍的圖則。任何影響該地段或其任何部分或該地段已建或擬建建築物或其部分的交易(但本批地文件的特別條件第(9)(c)條允許的租賃或租約，或租賃或租約的協議，或本批地文件的特別條件第(9)(d)條之下的建築按揭，或署長批准的其他交易除外)，在上述登記的一個曆月之後方可訂立。
- (b) 完成該勘察後，買方須自費於該地段內進行署長按其絕對酌情權要求的任何必要的緩解及鞏固工程(下稱「該等工程」)，以保護該地段或其任何部分的已建或擬建建築物，及其內之任何住戶或佔用人及其真正客人、訪客或受邀人免於來自山泥傾瀉危害研究區的山泥傾瀉危害，包括巨石下墜。
- (c) 如政府或買方或兩者均認為有必要於任何政府土地(包括山泥傾瀉研究區)進行緩解及鞏固工程(下稱「外區工程」)(須於其上進行或須就其進行外區工程的任何政府土地下稱「外區」)，買方須於收到署長就進行外區工程的批准或要求後，自費進行及完成外區工程以達至署長滿意程度。買方須自費於土地註冊處就該地段註冊一份獲署長接納的顯示外區及外區工程的位置、性質及範圍的圖則。
- (d) 買方須於本批地文件同意授予的年期內一切時候自費維修保養該等工程、外區工程及外區處於修葺良好堅固的狀況，達至署長滿意程度，以確保該等工程及外區工程持續運作。若買方違反本條規定的關於維修保養該等工程、外區工程及外區的義務，政府除就該等違反情況而享有的任何權利或補救方法之外，署長可透過書面通知方式要求買方進行署長按其絕對酌情權認為適當的維修保養工程。如買方忽視或未能在該通知指定的時期內遵從該項通知的要求以達至署長滿意程度，署長可立即執行及進行必要的維修保養工程，而買方須按政府償付該費用，連同任何行政和專業費用及收費。
- (e) 該勘察、該等工程及外區工程須在各方面遵守《建築物條例》、根據該條例制定的任何規例、任何修訂立法以及任何其他有關的政府立法。
- (f) 僅就進行該勘察、該等工程及外區工程和檢查及維修保養該等工程、外區工程及外區而言，買方有權進出外區，惟須受署長按其獨自酌情權施加的條款及條件之制約。
- (g) 如由於按照本特別條件的條款正在進行或已經進行的任何工程，導致或引起任何政府土地(包括外區)或該地段範圍外任何土地受到任何損害，買方須自費修復該等損害並於各方面達至署長滿意程度。

- (h) 對於按照本特別條件的條款正在進行或已經進行的任何工程，或買方遺漏、忽視或沒有進行任何該工程，或來自外區的任何山泥傾瀉危害(包括巨石下墜)，包括但不限於對財產及人命造成的任何損害或損失或人身傷害，或對與外區毗連或在外區之內的墳墓造成的任何干擾或損害，因而引起或附帶的一切訴訟、法律程序、責任、索償、費用和要求，買方特此向政府作出彌償並保持政府獲得彌償。」

### G. 指明住宅物業的每一公契關於該等設施、休憩用地及土地中的該等部分的條文

#### 8. 公契及管理協議(「公契」)第2(1)條規定：

「在本公契中，除文意另有所指外，下列字詞具有下述涵意：

「綠色間黑斜線範圍」

指隨附於批地條件的圖則A上綠色間黑斜線顯示的範圍，包括按照批地條件的特別條件第(23)條在該範圍完成的工程(包括該範圍之內及之上的土地、斜坡處理工程、護土構築物、排水渠及任何其他工程)；

「山泥傾瀉危害研究區」

指按照批地條件的特別條件第(60)(a)(ii)條在土地註冊處註冊的圖則(註冊摘要編號：09082702750070)上顯示的該部分範圍；

「該等工程及外區工程的維修保養手冊」

指該等工程和外區工程的維修保養手冊，其一份文本須保存於管理辦事處，在管理人正常辦公時間內可供業主免費查閱；

「外區」

指在該地段之外的任何政府土地，包括批地條件中詳細定義的山泥傾瀉危害研究區，而根據批地條件的特別條件第(60)(c)條，在有必要時須在外區上進行或須就其進行外區工程；

「外區工程」

指根據批地條件的特別條件第(60)(c)條被視為必須在外區進行的所有緩解及鞏固工程，且該等工程須予以維修保養以達至地政總署署長滿意程度；

「該等工程」

指根據批地條件或本公契須由業主維修保養的在該地段內一切必要的緩解及鞏固工程，以保護該地段和其任何部分及其內之任何住戶或佔用人及其真正客人、訪客或受邀人免於來自山泥傾瀉危害研究區的山泥傾瀉危害，包括巨石下墜；」

# INFORMATION ON PUBLIC FACILITIES AND PUBLIC OPEN SPACES

## 公共設施及公眾休憩用地的資料

### 9. 公契第14(a)(xv)條規定：

「管理人在備製下一年度的年度預算時須徵詢業主委員會(如有)的意見，但第一份預算除外，其涵蓋期間自本公契的日期起至下一個12月31日止。年度預算須包括兩個部分：

(a) 第一部分須涵蓋管理人認為(除有明顯錯誤外，管理人的決定是最終決定)將為全體業主的利益所開銷或須用於恰當管理發展項目及其內發展項目公用地方及設施的一切支出，包括(但在不損害上文的一般性的原則下)：

……

(xv) 檢查、維修保養、復原、修理及進行該等工程(如有)、外區工程(如有)、已建或將建的地基、支柱及其他構築物，並在遇有任何山泥傾瀉、地陷或塌方時進行復原和修復，以及根據批地條件或為發展項目的正常運作須進行維修保養的排水渠、明渠、污水渠、管道、水管及渠道以及其他範圍，不論其在該地段之內或之外，因而發生的費用及開支；

……」

### 10. 公契第36(ab)、(az)及(ba)條規定：

「該地段與發展項目由管理人進行管理，首個期限不超過兩(2)年，並持續直至根據本公契第10條的規定終止為止。每名業主特此不可撤銷地委任管理人就涉及公用地方及設施的任何事宜擔任全體業主的代理人，按照本公契的條文獲得正式授權，在遵守《建築物管理條例》(第344章)的前提下執行和落實本公契的一切條文。除本公契明示規定的其他權力外，管理人還有權就該地段、發展項目及其管理作出所有必需或適宜的行為及事情，特別包括以下各項但在任何方面限制前述規定的一般適用性：

……

(ab) 有全權代表全體業主就在任何方面涉及或有關該地段及整個發展項目或公用地方及設施、綠色間黑斜線範圍、山泥傾瀉危害研究區及外區的一切事宜與政府、任何法定機構、任何公用事業公司、其他主管機構或任何其他人士往來，並有權以通過上述任何交往所採納的任何政策、作出的決定或採取的行動約束全體業主；

……

(az) 聘請合資格人員，在遵守批地條件、《建築物條例》、根據該條例制定的任何規例、任何修訂立法以及任何其他有關的政府立法的情況下，及/或按照有關政府部門就該等工程不時發出的一切指引，進行、完成、維修保養該地段內的該等工程和確保其持續運作，並向業主收取管理人在進行上述工程及維修保養時合法地招致或將會招致的一切費用，但管理人無須就執行批地條件的任何上述規定及/或上述指引負個人責任，而如果管理人在作出一切合理努力後仍未能按照本公契的條款從全體業主收取所需工程的費用，執行上述規定的責任仍由業主承擔；

(ba) 聘請合資格人員，在遵守批地條件、《建築物條例》、根據該條例制定的任何規例、任何修訂立法以及任何其他有關的政府立法的情況下，及/或按照有關政府部門就外區工程不時發出的一切指引，進行、完成、維修保養外區內的外區工程和確保其持續運作，並向業主收取管理人在進行上述工程及維修保養時合法地招致或將會招致的一切費用，但管理人無須就執行批地條件的任何上述規定及/或上述指引負個人責任，而如果管理人在作出一切合理努力後仍未能按照本公契的條款從全體業主收取所需工程的費用，執行上述規定的責任仍由業主承擔；

……」

### 11. 公契第三附錄第37條規定：

「(a) 業主須按其各自單位所獲分配的管理份數數目之比例自費維修保養該等工程、外區工程及外區處於修葺良好堅固的狀況，並在其上或對其進行相關工程以達至地政總署署長滿意程度，同時遵守和符合特別條件第(60)條與批地條件的任何其他條文以及該等工程及外區工程的維修保養手冊。

(b) 第一業主須在本公契的日期起一個月內將該等工程及外區工程的維修保養手冊全套存放於管理辦事處。該等工程及外區工程的維修保養手冊須於管理人正常辦公時間內供業主免費查閱，並在業主支付合理的影印費後可按業主要求進行影印。收取的所有費用須貸記入特別基金。」

# INFORMATION ON PUBLIC FACILITIES AND PUBLIC OPEN SPACES 公共設施及公眾休憩用地的資料

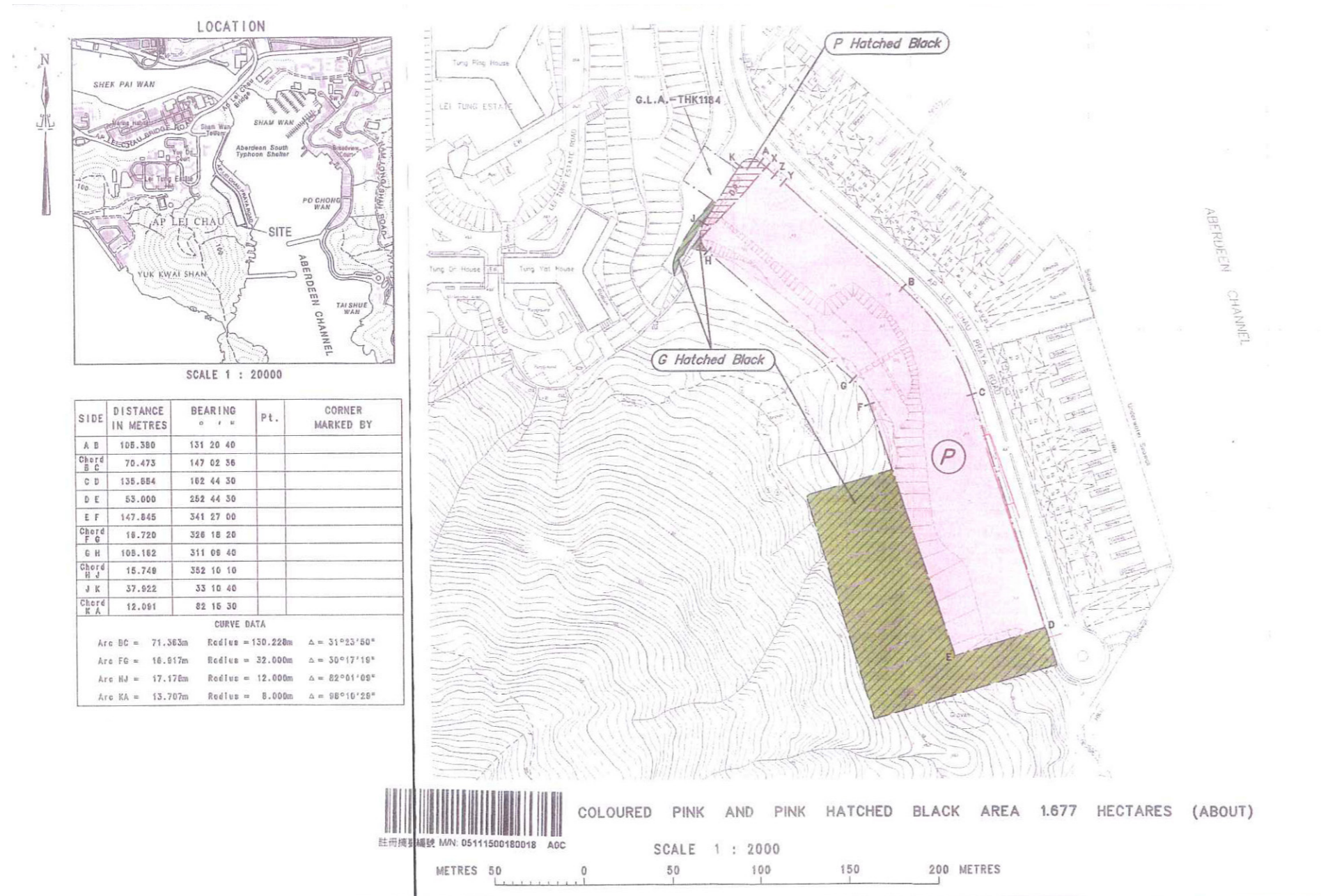

粉紅色間黑斜線

綠色間黑斜線



附註：

此圖摘錄自附於批地文件的圖則，以標示綠色間黑斜線範圍及粉紅色間黑斜線範圍(渠務預留區域)。



# WARNING TO PURCHASERS

## 對買方的警告

- (a) The purchaser is recommended to instruct a separate firm of solicitors (other than that acting for the owner) to act for the purchaser in relation to the transaction.
  - (b) If the purchaser instructs such separate firm of solicitors to act for the purchaser in relation to the transaction, that firm will be able to give independent advice to the purchaser.
  - (c) If the purchaser instructs the firm of solicitors acting for the owner to act for the purchaser as well, and a conflict of interest arises between the owner and the purchaser,
    - (i) that firm may not be able to protect the purchaser's interests; and
    - (ii) the purchaser may have to instruct a separate firm of solicitors; and
    - (iii) in the case of paragraph (c)(ii), the total solicitors' fees payable by the purchaser may be higher than the fees that would have been payable if the purchaser had instructed a separate firm of solicitors in the first place.
- (a) 現建議買方聘用一間獨立的律師事務所(代表擁有人行事者除外)，以在交易中代表買方行事。
  - (b) 如買方聘用上述的獨立的律師事務所，以在交易中代表買方行事，該律師事務所將會能夠向買方提供獨立意見。
  - (c) 如買方聘用代表擁有人行事的律師事務所同時代表買方行事，而擁有人與買方之間出現利益衝突—
    - (i) 該律師事務所可能不能夠保障買方的利益；及
    - (ii) 買方可能要聘用一間獨立的律師事務所；及
    - (iii) 如屬(c)(ii)段的情況，買方須支付的律師費用總數，可能高於如買方自一開始即聘用一間獨立的律師事務所便須支付的費用。

# CROSS-SECTION PLAN OF BUILDING IN THE DEVELOPMENT

## 發展項目中的建築物的橫截面圖

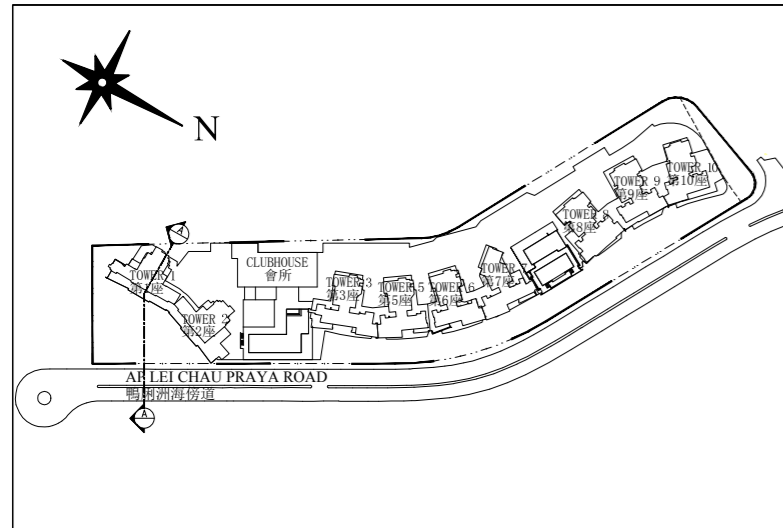

Key Plan 指示圖

### TOWER 1 第1座

TOP ROOF	頂層天台
ROOF	LIFT MACHINE ROOM
天台	升降機機房
39/F UPPER DUPLICATE UNIT	PUMP ROOM
39樓複式住宅單位	泵房
38/F LOWER DUPLICATE UNIT	
38樓複式住宅單位	
37/F RESIDENTIAL UNIT	
37樓住宅單位	
36/F RESIDENTIAL UNIT	36樓住宅單位
35/F RESIDENTIAL UNIT	35樓住宅單位
33/F RESIDENTIAL UNIT	33樓住宅單位
32/F RESIDENTIAL UNIT	32樓住宅單位
31/F RESIDENTIAL UNIT	31樓住宅單位
30/F RESIDENTIAL UNIT	30樓住宅單位
29/F RESIDENTIAL UNIT	29樓住宅單位
28/F RESIDENTIAL UNIT	28樓住宅單位
27/F RESIDENTIAL UNIT	27樓住宅單位
26/F RESIDENTIAL UNIT	26樓住宅單位
25/F RESIDENTIAL UNIT	25樓住宅單位
23/F RESIDENTIAL UNIT	23樓住宅單位
22/F RESIDENTIAL UNIT	22樓住宅單位
TRANSFER PLATE	21/F RESIDENTIAL UNIT
轉換層	21樓住宅單位
REFUGE FLOOR / SKY GARDEN	20/F RESIDENTIAL UNIT
庇護層 / 空中花園	20樓住宅單位
	REFUGE FLOOR
	庇護層
18/F RESIDENTIAL UNIT	18樓住宅單位
17/F RESIDENTIAL UNIT	17樓住宅單位
16/F RESIDENTIAL UNIT	16樓住宅單位
15/F RESIDENTIAL UNIT	15樓住宅單位
12/F RESIDENTIAL UNIT	12樓住宅單位
11/F RESIDENTIAL UNIT	11樓住宅單位
10/F RESIDENTIAL UNIT	10樓住宅單位
9/F RESIDENTIAL UNIT	9樓住宅單位
8/F RESIDENTIAL UNIT	8樓住宅單位
7/F RESIDENTIAL UNIT	7樓住宅單位
	TRANSFER PLATE
	轉換層
5/F LANDSCAPE GARDEN	5/F LIFT LOBBY
有蓋園林	升降機大堂
3/F CLUB HOUSE	3/F LIFT LOBBY
會所	升降機大堂
1/F MAIN ENTRANCE LOBBY	2/F PIPE DUCT ROOM
入口大堂	管道機房
	1/F LIFT LOBBY
	升降機大堂
	G/F CAR PARK
	停車場

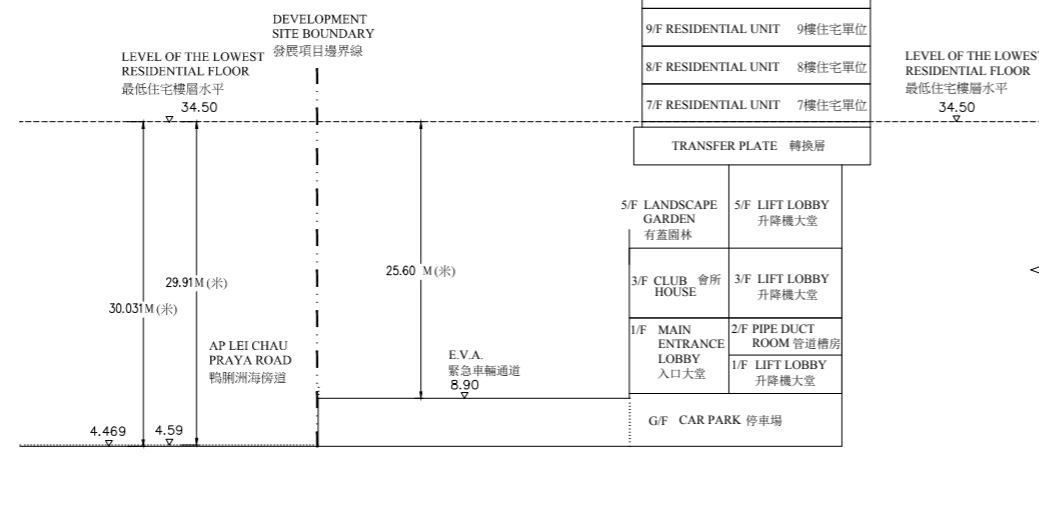

### CROSS-SECTION PLAN A-A 橫截面圖 A-A

1. The Part of Ap Lei Chau Praya Road adjacent to the building is 4.469 metre to 4.59 metre above the Hong Kong Principal Datum.
  2. The Part of Emergency Vehicular Access adjacent to the building is 8.90 metre above the Hong Kong Principal Datum.
  3. Dotted line denotes the lowest residential floor.
1. 毗鄰建築物的一段鴨脷洲海傍道為香港主水平基準以上 4.469 米至 4.59 米。
  2. 毗鄰建築物的一段緊急車輛通道為香港主水平基準以上 8.90 米。
  3. 虛線為最低住宅樓層水平。

# CROSS-SECTION PLAN OF BUILDING IN THE DEVELOPMENT 發展項目中的建築物的橫截面圖

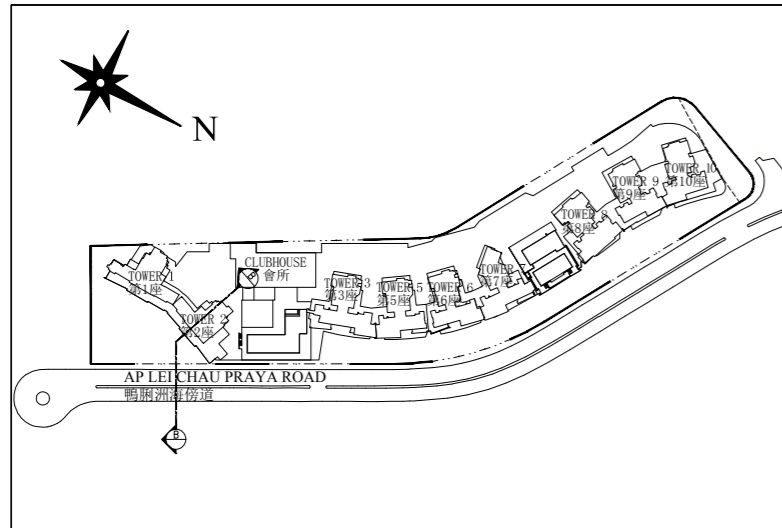

Key Plan 指示圖

## TOWER 2 第2座

TOP ROOF	頂層天台
ROOF	天台
39/F UPPER DUPLEX UNIT	39樓複式住宅單位
38/F LOWER DUPLEX UNIT	38樓複式住宅單位
37/F RESIDENTIAL UNIT	37樓住宅單位
36/F RESIDENTIAL UNIT	36樓住宅單位
35/F RESIDENTIAL UNIT	35樓住宅單位
33/F RESIDENTIAL UNIT	33樓住宅單位
32/F RESIDENTIAL UNIT	32樓住宅單位
31/F RESIDENTIAL UNIT	31樓住宅單位
30/F RESIDENTIAL UNIT	30樓住宅單位
29/F RESIDENTIAL UNIT	29樓住宅單位
28/F RESIDENTIAL UNIT	28樓住宅單位
27/F RESIDENTIAL UNIT	27樓住宅單位
26/F RESIDENTIAL UNIT	26樓住宅單位
25/F RESIDENTIAL UNIT	25樓住宅單位
23/F RESIDENTIAL UNIT	23樓住宅單位
22/F RESIDENTIAL UNIT	22樓住宅單位
TRANSFER PLATE	轉換層
REFUGE FLOOR / SKY GARDEN	庇護層 / 空中花園
21/F RESIDENTIAL UNIT	21樓住宅單位
20/F RESIDENTIAL UNIT	20樓住宅單位
18/F RESIDENTIAL UNIT	18樓住宅單位
17/F RESIDENTIAL UNIT	17樓住宅單位
16/F RESIDENTIAL UNIT	16樓住宅單位
15/F RESIDENTIAL UNIT	15樓住宅單位
12/F RESIDENTIAL UNIT	12樓住宅單位
11/F RESIDENTIAL UNIT	11樓住宅單位
10/F RESIDENTIAL UNIT	10樓住宅單位
9/F RESIDENTIAL UNIT	9樓住宅單位
8/F RESIDENTIAL UNIT	8樓住宅單位
7/F RESIDENTIAL UNIT	7樓住宅單位

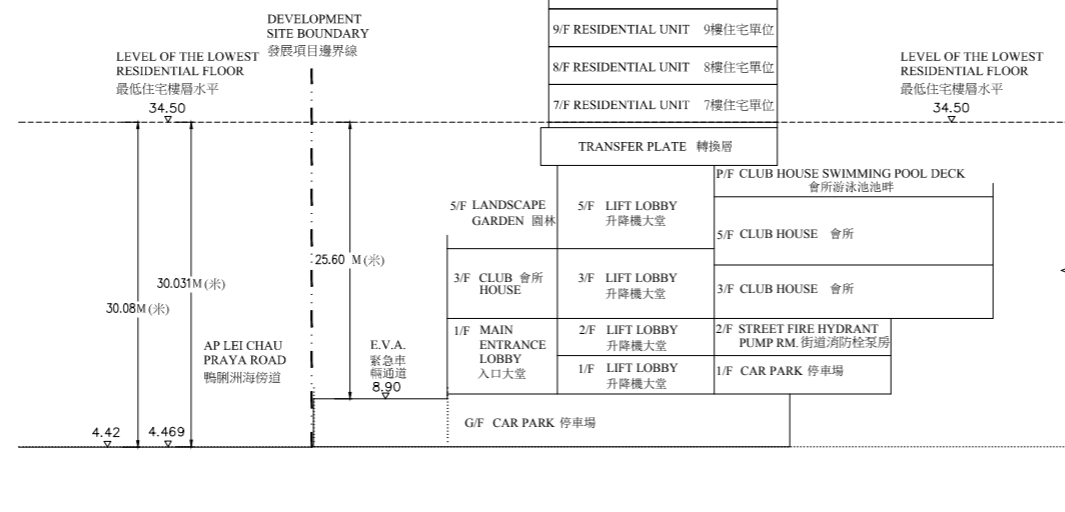

## CROSS-SECTION PLAN B-B 橫截面圖 B-B

1. The Part of Ap Lei Chau Praya Road adjacent to the building is 4.42 metre to 4.469 metre above the Hong Kong Principal Datum.
  2. The Part of Emergency Vehicular Access adjacent to the building is 8.90 metre above the Hong Kong Principal Datum.
  3. Dotted line denotes the lowest residential floor.
1. 毗鄰建築物的一段鴨脷洲海傍道為香港主水平基準以上 4.42米至 4.469米。
  2. 毗鄰建築物的一段緊急車輛通道為香港主水平基準以上 8.90米。
  3. 虛線為最低住宅樓層水平。



# CROSS-SECTION PLAN OF BUILDING IN THE DEVELOPMENT

## 發展項目中的建築物的橫截面圖

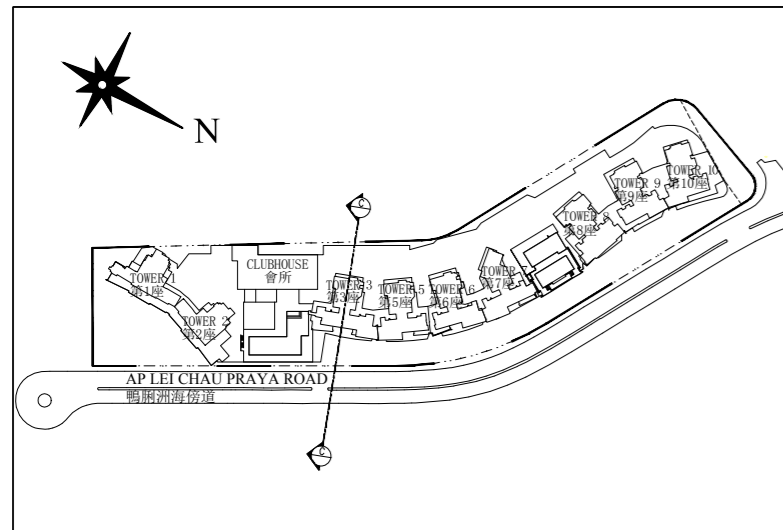

Key Plan 指示圖

### TOWER 3 第3座

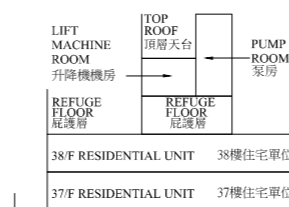

38/F RESIDENTIAL UNIT	38樓住宅單位
37/F RESIDENTIAL UNIT	37樓住宅單位
36/F RESIDENTIAL UNIT	36樓住宅單位
35/F RESIDENTIAL UNIT	35樓住宅單位
33/F RESIDENTIAL UNIT	33樓住宅單位
32/F RESIDENTIAL UNIT	32樓住宅單位
31/F RESIDENTIAL UNIT	31樓住宅單位
30/F RESIDENTIAL UNIT	30樓住宅單位
29/F RESIDENTIAL UNIT	29樓住宅單位
28/F RESIDENTIAL UNIT	28樓住宅單位
27/F RESIDENTIAL UNIT	27樓住宅單位
26/F RESIDENTIAL UNIT	26樓住宅單位
25/F RESIDENTIAL UNIT	25樓住宅單位
23/F RESIDENTIAL UNIT	23樓住宅單位
22/F RESIDENTIAL UNIT	22樓住宅單位
21/F RESIDENTIAL UNIT	21樓住宅單位
20/F RESIDENTIAL UNIT	20樓住宅單位
19/F RESIDENTIAL UNIT	19樓住宅單位
18/F RESIDENTIAL UNIT	18樓住宅單位
17/F RESIDENTIAL UNIT	17樓住宅單位
16/F RESIDENTIAL UNIT	16樓住宅單位
15/F RESIDENTIAL UNIT	15樓住宅單位
12/F RESIDENTIAL UNIT	12樓住宅單位
11/F RESIDENTIAL UNIT	11樓住宅單位
10/F RESIDENTIAL UNIT	10樓住宅單位
9/F RESIDENTIAL UNIT	9樓住宅單位
8/F RESIDENTIAL UNIT	8樓住宅單位
7/F RESIDENTIAL UNIT	7樓住宅單位

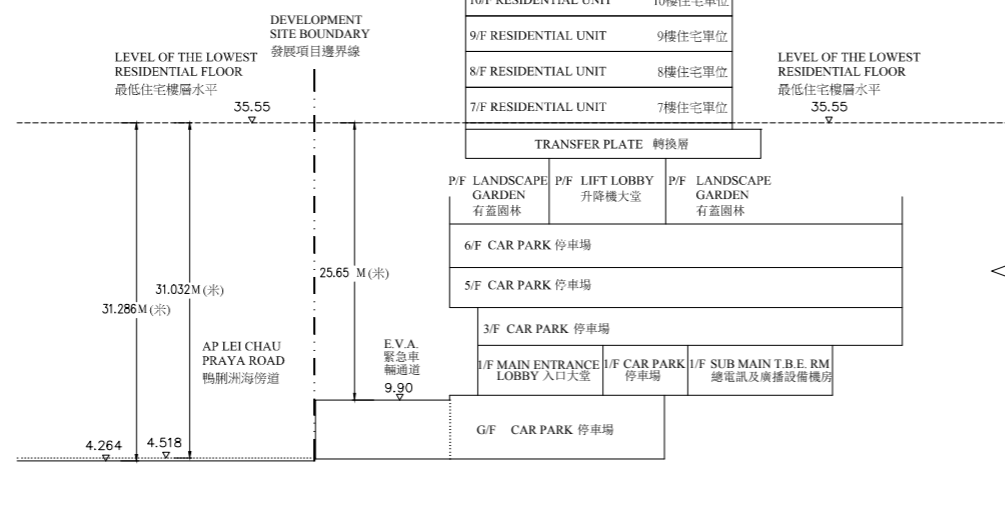

### CROSS-SECTION PLAN C-C 橫截面圖 C-C

1. The Part of Ap Lei Chau Praya Road adjacent to the building is 4.264 metre to 4.518 metre above the Hong Kong Principal Datum.
  2. The Part of Emergency Vehicular Access adjacent to the building is 9.90 metre above the Hong Kong Principal Datum.
  3. Dotted line denotes the lowest residential floor.
1. 毗鄰建築物的一段鴨脷洲海傍道為香港主水平基準以上 4.264米至 4.518米。
  2. 毗鄰建築物的一段緊急車輛通道為香港主水平基準以上 9.90米。
  3. 虛線為最低住宅樓層水平。

# CROSS-SECTION PLAN OF BUILDING IN THE DEVELOPMENT 發展項目中的建築物的橫截面圖

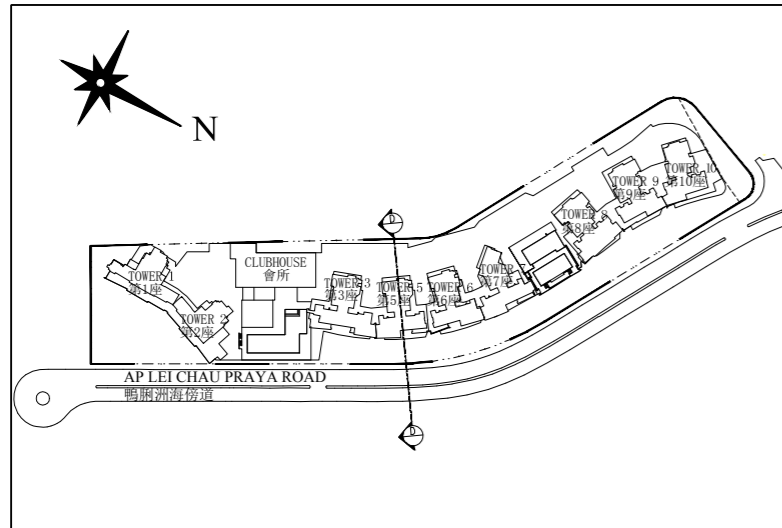

Key Plan 指示圖

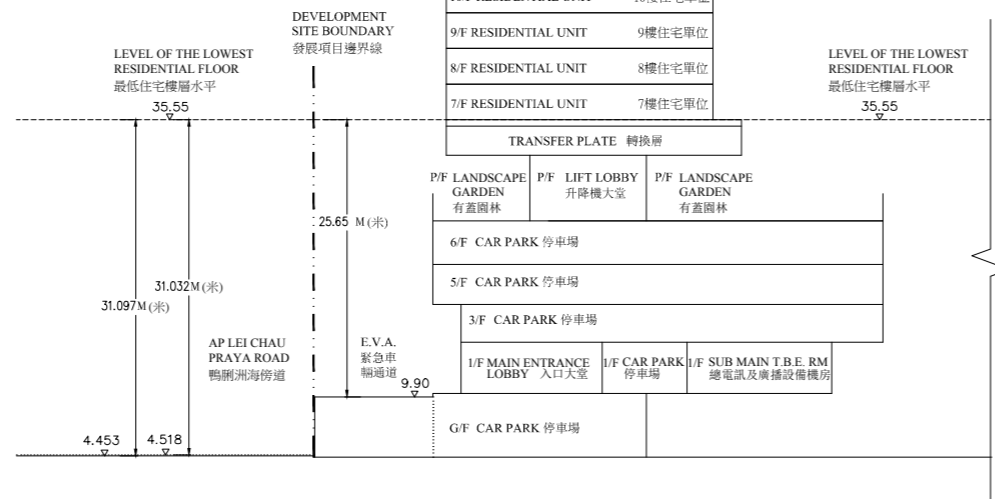

CROSS-SECTION PLAN D-D  
橫截面圖 D-D

1. The Part of Ap Lei Chau Praya Road adjacent to the building is 4.453 metre to 4.518 metre above the Hong Kong Principal Datum.
  2. The Part of Emergency Vehicular Access adjacent to the building is 9.90 metre above the Hong Kong Principal Datum.
  3. Dotted line denotes the lowest residential floor.
1. 毗鄰建築物的一段鴨脷洲海傍道為香港主水平基準以上 4.453米至 4.518米。
  2. 毗鄰建築物的一段緊急車輛通道為香港主水平基準以上9.90米。
  3. 虛線為最低住宅樓層水平。

# CROSS-SECTION PLAN OF BUILDING IN THE DEVELOPMENT

## 發展項目中的建築物的橫截面圖

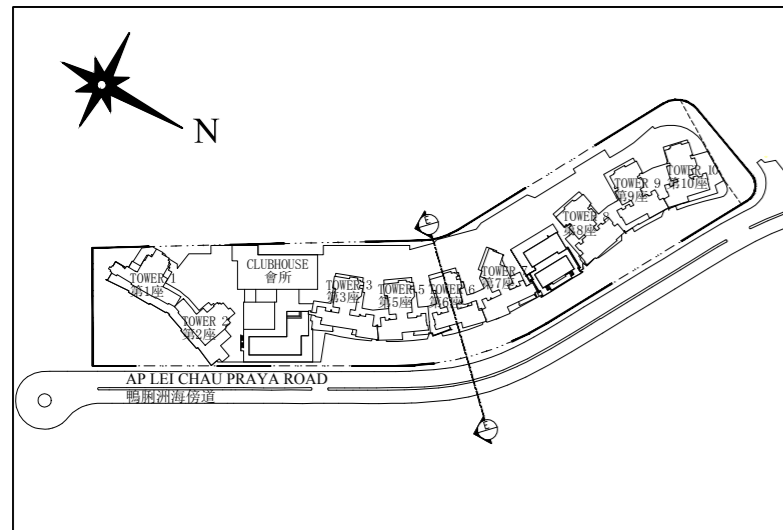

Key Plan 指示圖

**TOWER 6**  
第6座

LIFT MACHINE ROOM 升降機機房	TOP ROOF 頂層天台	PUMP ROOM 泵房
ROOF 天台	ROOF 天台	
39/F RESIDENTIAL UNIT 39樓住宅單位		
38/F RESIDENTIAL UNIT 38樓住宅單位		
37/F RESIDENTIAL UNIT 37樓住宅單位		
36/F RESIDENTIAL UNIT 36樓住宅單位		
35/F RESIDENTIAL UNIT 35樓住宅單位		
33/F RESIDENTIAL UNIT 33樓住宅單位		
32/F RESIDENTIAL UNIT 32樓住宅單位		
31/F RESIDENTIAL UNIT 31樓住宅單位		
30/F RESIDENTIAL UNIT 30樓住宅單位		
29/F RESIDENTIAL UNIT 29樓住宅單位		
28/F RESIDENTIAL UNIT 28樓住宅單位		
27/F RESIDENTIAL UNIT 27樓住宅單位		
26/F RESIDENTIAL UNIT 26樓住宅單位		
25/F RESIDENTIAL UNIT 25樓住宅單位		
23/F RESIDENTIAL UNIT 23樓住宅單位		
TRANSFER PLATE 轉接層	22/F RESIDENTIAL UNIT 22樓住宅單位	
REFUGE FLOOR/ SKY GARDEN 庇護層/空中花園	REFUGE FLOOR/ SKY GARDEN 庇護層/空中花園	
19/F RESIDENTIAL UNIT 19樓住宅單位		
18/F RESIDENTIAL UNIT 18樓住宅單位		
17/F RESIDENTIAL UNIT 17樓住宅單位		
16/F RESIDENTIAL UNIT 16樓住宅單位		
15/F RESIDENTIAL UNIT 15樓住宅單位		
12/F RESIDENTIAL UNIT 12樓住宅單位		
11/F RESIDENTIAL UNIT 11樓住宅單位		
10/F RESIDENTIAL UNIT 10樓住宅單位		
9/F RESIDENTIAL UNIT 9樓住宅單位		
8/F RESIDENTIAL UNIT 8樓住宅單位		
7/F RESIDENTIAL UNIT 7樓住宅單位		

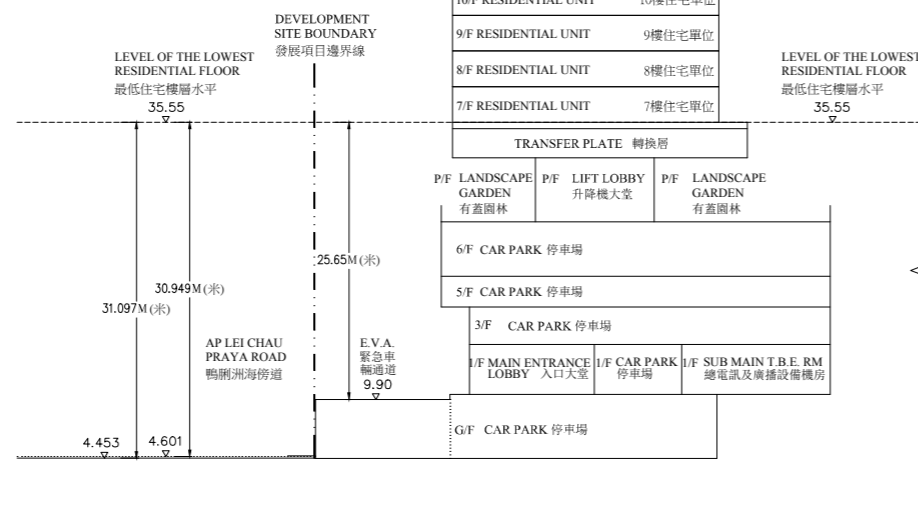

CROSS-SECTION PLAN E-E  
橫截面圖 E-E

1. The Part of Ap Lei Chau Praya Road adjacent to the building is 4.453 metre to 4.601 metre above the Hong Kong Principal Datum.
  2. The Part of Emergency Vehicular Access adjacent to the building is 9.90 metre above the Hong Kong Principal Datum.
  3. Dotted line denotes the lowest residential floor.
1. 毗鄰建築物的一段鴨脷洲海傍道為香港主水平基準以上 4.453米至 4.601米。
  2. 毗鄰建築物的一段緊急車輛通道為香港主水平基準以上 9.90米。
  3. 虛線為最低住宅樓層水平。

# CROSS-SECTION PLAN OF BUILDING IN THE DEVELOPMENT 發展項目中的建築物的橫截面圖

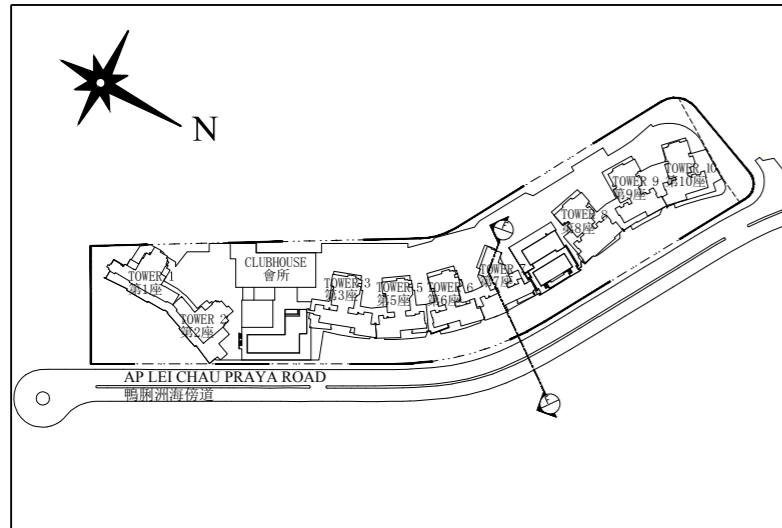

Key Plan 指示圖

TOWER 7 第7座	
LIFT MACHINE ROOM 升降機機房	TOP ROOF 頂層天台
ROOF 天台	PUMP ROOM 泵房
39/F RESIDENTIAL UNIT 39樓住宅單位	ROOF 天台
38/F RESIDENTIAL UNIT 38樓住宅單位	
37/F RESIDENTIAL UNIT 37樓住宅單位	
36/F RESIDENTIAL UNIT 36樓住宅單位	
35/F RESIDENTIAL UNIT 35樓住宅單位	
33/F RESIDENTIAL UNIT 33樓住宅單位	
32/F RESIDENTIAL UNIT 32樓住宅單位	
31/F RESIDENTIAL UNIT 31樓住宅單位	
30/F RESIDENTIAL UNIT 30樓住宅單位	
29/F RESIDENTIAL UNIT 29樓住宅單位	
28/F RESIDENTIAL UNIT 28樓住宅單位	
27/F RESIDENTIAL UNIT 27樓住宅單位	
26/F RESIDENTIAL UNIT 26樓住宅單位	
25/F RESIDENTIAL UNIT 25樓住宅單位	
23/F RESIDENTIAL UNIT 23樓住宅單位	
TRANSFER PLATE 轉換層	22/F RESIDENTIAL UNIT 22樓住宅單位
REFUGE FLOOR/ SKY GARDEN 庇護層/空中花園	REFUGE FLOOR/ SKY GARDEN 庇護層/空中花園
19/F RESIDENTIAL UNIT 19樓住宅單位	
18/F RESIDENTIAL UNIT 18樓住宅單位	
17/F RESIDENTIAL UNIT 17樓住宅單位	
16/F RESIDENTIAL UNIT 16樓住宅單位	
15/F RESIDENTIAL UNIT 15樓住宅單位	
12/F RESIDENTIAL UNIT 12樓住宅單位	
11/F RESIDENTIAL UNIT 11樓住宅單位	
10/F RESIDENTIAL UNIT 10樓住宅單位	
9/F RESIDENTIAL UNIT 9樓住宅單位	
8/F RESIDENTIAL UNIT 8樓住宅單位	
7/F RESIDENTIAL UNIT 7樓住宅單位	
TRANSFER PLATE 轉換層	
P/F LANDSCAPE GARDEN 有蓋園林	P/F LIFT LOBBY 升降機大堂
P/F LANDSCAPE GARDEN 有蓋園林	
6/F CAR PARK 停車場	
5/F CAR PARK 停車場	
3/F CAR PARK 停車場	
1/F MAIN ENTRANCE LOBBY 入口大堂	1/F CAR PARK 停車場
G/F CAR PARK 停車場	

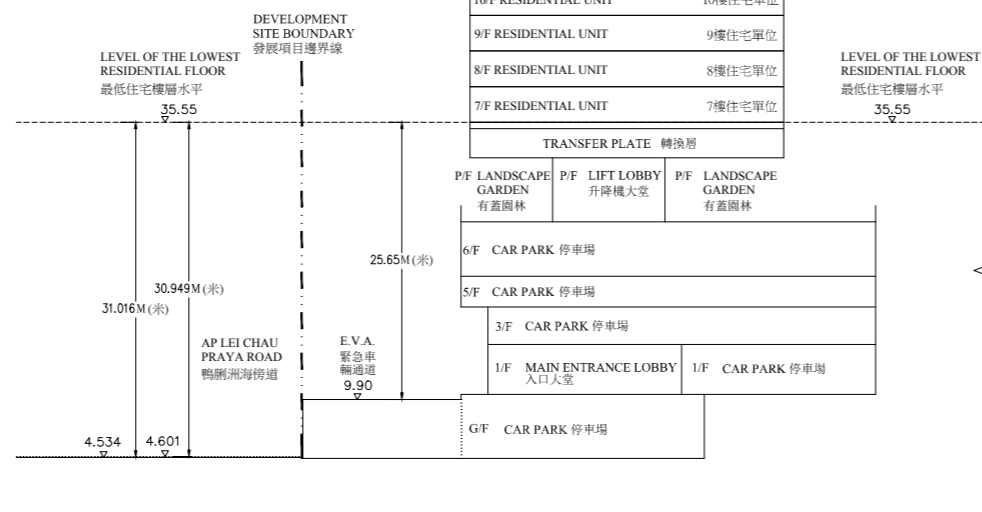

CROSS-SECTION PLAN F-F  
橫截面圖 F-F

- The Part of Ap Lei Chau Praya Road adjacent to the building is 4.534 metre to 4.601 metre above the Hong Kong Principal Datum.
  - The Part of Emergency Vehicular Access adjacent to the building is 9.90 metre above the Hong Kong Principal Datum.
  - Dotted line denotes the lowest residential floor.
- 毗鄰建築物的一段鴨脷洲海傍道為香港主水平基準以上 4.534米至 4.601米。
  - 毗鄰建築物的一段緊急車輛通道為香港主水平基準以上9.90米。
  - 虛線為最低住宅樓層水平。

# CROSS-SECTION PLAN OF BUILDING IN THE DEVELOPMENT

## 發展項目中的建築物的橫截面圖

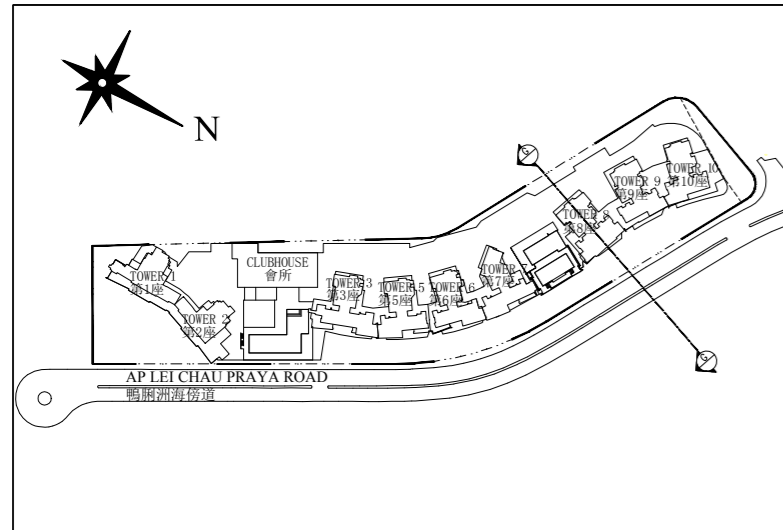

Key Plan 指示圖

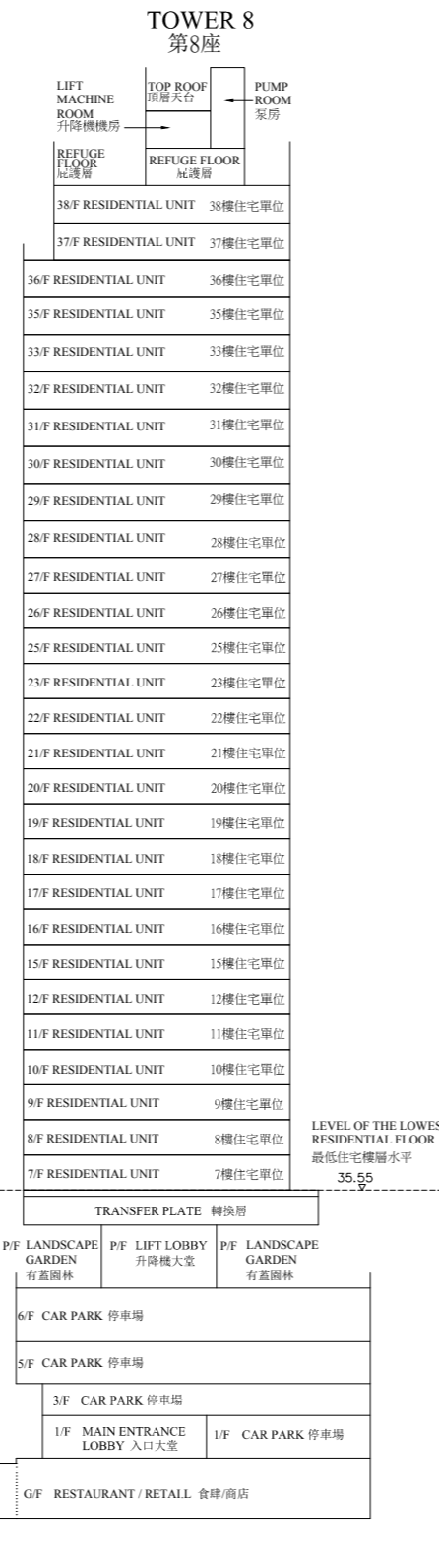

CROSS-SECTION PLAN G-G  
橫截面圖 G-G

1. The Part of Ap Lei Chau Praya Road adjacent to the building is 4.419 metre to 4.773 metre above the Hong Kong Principal Datum.
  2. The Part of Emergency Vehicular Access adjacent to the building is 9.90 metre above the Hong Kong Principal Datum.
  3. Dotted line denotes the lowest residential floor.
1. 毗鄰建築物的一段鴨脷洲海傍道為香港主水平基準以上 4.419米至 4.773米。
  2. 毗鄰建築物的一段緊急車輛通道為香港主水平基準以上9.90米。
  3. 虛線為最低住宅樓層水平。

# CROSS-SECTION PLAN OF BUILDING IN THE DEVELOPMENT 發展項目中的建築物的橫截面圖

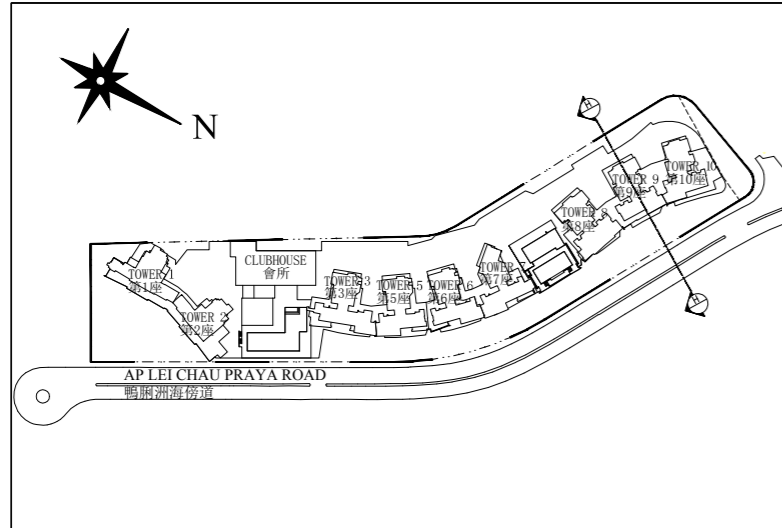

Key Plan 指示圖

TOWER 9 第9座	
LIFT MACHINE ROOM 升降機機房	TOP ROOF 頂層天台
ROOF 天台	PUMP ROOM 泵房
37/F RESIDENTIAL UNIT 37樓住宅單位	ROOF 天台
36/F RESIDENTIAL UNIT 36樓住宅單位	
35/F RESIDENTIAL UNIT 35樓住宅單位	
33/F RESIDENTIAL UNIT 33樓住宅單位	
32/F RESIDENTIAL UNIT 32樓住宅單位	
31/F RESIDENTIAL UNIT 31樓住宅單位	
30/F RESIDENTIAL UNIT 30樓住宅單位	
29/F RESIDENTIAL UNIT 29樓住宅單位	
28/F RESIDENTIAL UNIT 28樓住宅單位	
27/F RESIDENTIAL UNIT 27樓住宅單位	
26/F RESIDENTIAL UNIT 26樓住宅單位	
TRANSFER PLATE 轉換層	25/F RESIDENTIAL UNIT 25樓住宅單位
	23/F RESIDENTIAL UNIT 23樓住宅單位
REFUGE FLOOR/ SKY GARDEN 庇護層/空中花園	22/F RESIDENTIAL UNIT 22樓住宅單位
	REFUGE FLOOR 庇護層
19/F RESIDENTIAL UNIT 19樓住宅單位	
18/F RESIDENTIAL UNIT 18樓住宅單位	
17/F RESIDENTIAL UNIT 17樓住宅單位	
16/F RESIDENTIAL UNIT 16樓住宅單位	
15/F RESIDENTIAL UNIT 15樓住宅單位	
12/F RESIDENTIAL UNIT 12樓住宅單位	
11/F RESIDENTIAL UNIT 11樓住宅單位	
10/F RESIDENTIAL UNIT 10樓住宅單位	
9/F RESIDENTIAL UNIT 9樓住宅單位	
8/F RESIDENTIAL UNIT 8樓住宅單位	
7/F RESIDENTIAL UNIT 7樓住宅單位	

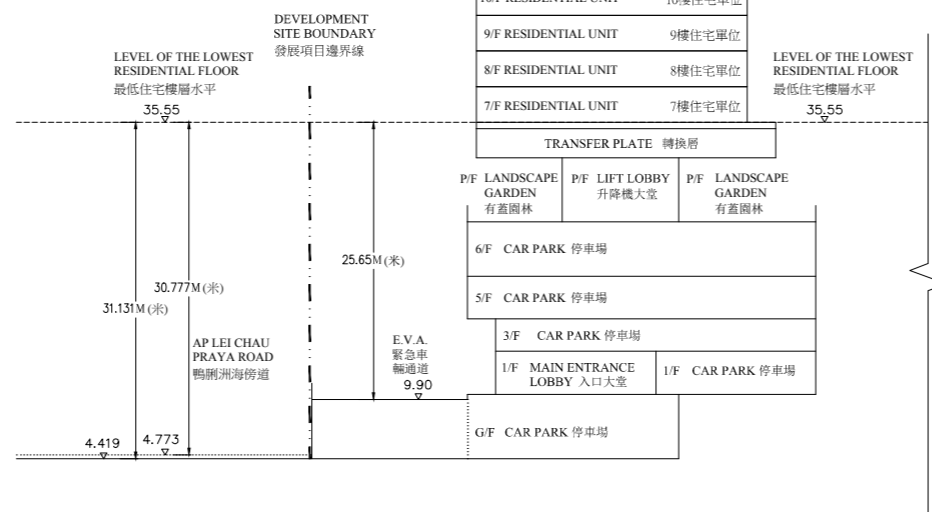

CROSS-SECTION PLAN H-H  
橫截面圖 H-H

1. The Part of Ap Lei Chau Praya Road adjacent to the building is 4.419 metre to 4.773 metre above the Hong Kong Principal Datum.
  2. The Part of Emergency Vehicular Access adjacent to the building is 9.90 metre above the Hong Kong Principal Datum.
  3. Dotted line denotes the lowest residential floor.
1. 毗鄰建築物的一段鴨脷洲海傍道為香港主水平基準以上 4.419米至 4.773米。
  2. 毗鄰建築物的一段緊急車輛通道為香港主水平基準以上9.90米。
  3. 虛線為最低住宅樓層水平。

# CROSS-SECTION PLAN OF BUILDING IN THE DEVELOPMENT

## 發展項目中的建築物的橫截面圖

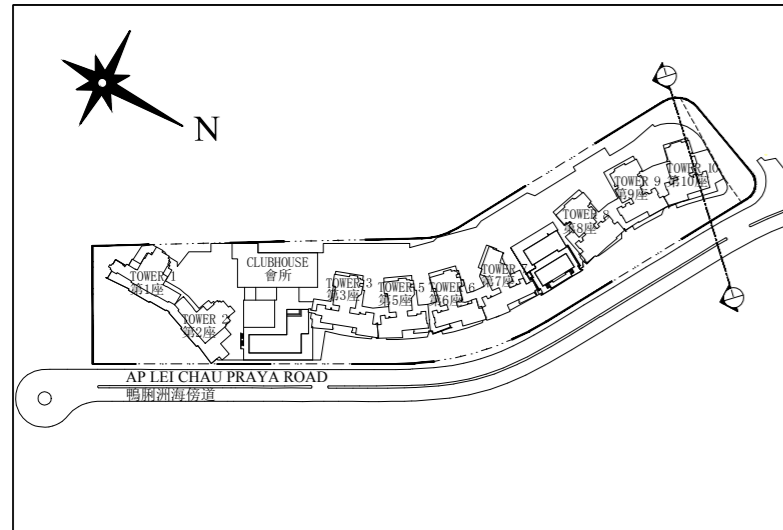

Key Plan 指示圖

**TOWER 10**  
第10座

LIFT MACHINE ROOM 升降機機房	TOP ROOF 頂層天台	PUMP ROOM 泵房
ROOF 天台	ROOF 天台	ROOF 天台
37/F RESIDENTIAL UNIT 37樓住宅單位		
36/F RESIDENTIAL UNIT 36樓住宅單位		
35/F RESIDENTIAL UNIT 35樓住宅單位		
33/F RESIDENTIAL UNIT 33樓住宅單位		
32/F RESIDENTIAL UNIT 32樓住宅單位		
31/F RESIDENTIAL UNIT 31樓住宅單位		
30/F RESIDENTIAL UNIT 30樓住宅單位		
29/F RESIDENTIAL UNIT 29樓住宅單位		
28/F RESIDENTIAL UNIT 28樓住宅單位		
27/F RESIDENTIAL UNIT 27樓住宅單位		
26/F RESIDENTIAL UNIT 26樓住宅單位		
TRANSFER PLATE 轉換層	25/F RESIDENTIAL UNIT 25樓住宅單位	
	23/F RESIDENTIAL UNIT 23樓住宅單位	
REFUGE FLOOR/ SKY GARDEN 庇護層/空中花園	22/F RESIDENTIAL UNIT 22樓住宅單位	
	REFUGE FLOOR 庇護層	
	19/F RESIDENTIAL UNIT 19樓住宅單位	
	18/F RESIDENTIAL UNIT 18樓住宅單位	
	17/F RESIDENTIAL UNIT 17樓住宅單位	
	16/F RESIDENTIAL UNIT 16樓住宅單位	
	15/F RESIDENTIAL UNIT 15樓住宅單位	
	12/F RESIDENTIAL UNIT 12樓住宅單位	
	11/F RESIDENTIAL UNIT 11樓住宅單位	
	10/F RESIDENTIAL UNIT 10樓住宅單位	
	9/F RESIDENTIAL UNIT 9樓住宅單位	
	8/F RESIDENTIAL UNIT 8樓住宅單位	
	7/F RESIDENTIAL UNIT 7樓住宅單位	

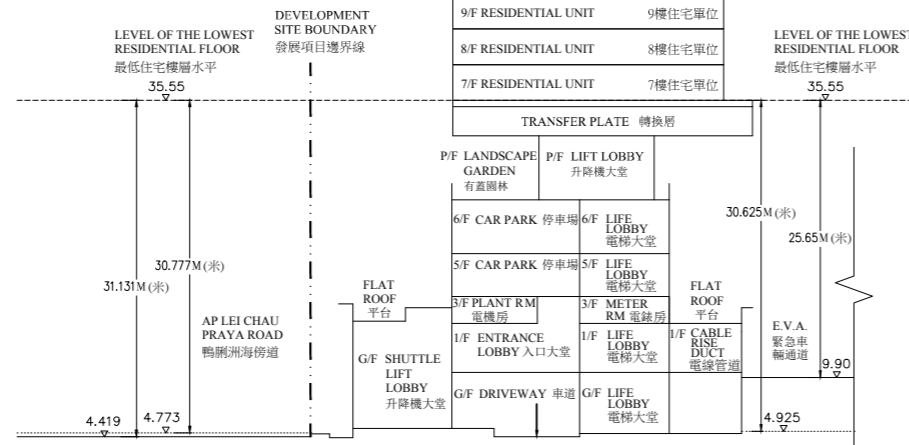

CROSS-SECTION PLAN I-I  
橫截面圖 I-I

- The Part of Ap Lei Chau Praya Road adjacent to the building is 4.419 metre to 4.773 metre above the Hong Kong Principal Datum.
  - The Part of Emergency Vehicular Access adjacent to the building is 4.925 metre to 9.90 metre above the Hong Kong Principal Datum.
  - Dotted line denotes the lowest residential floor.
- 毗鄰建築物的一段鴨脷洲海傍道為香港主水平基準以上 4.419米至 4.773米。
  - 毗鄰建築物的一段緊急車輛通道為香港主水平基準以上 4.925米至 9.90米。
  - 虛線為最低住宅樓層水平。

# ELEVATION PLAN FOR THE DEVELOPMENT 發展項目的立面圖

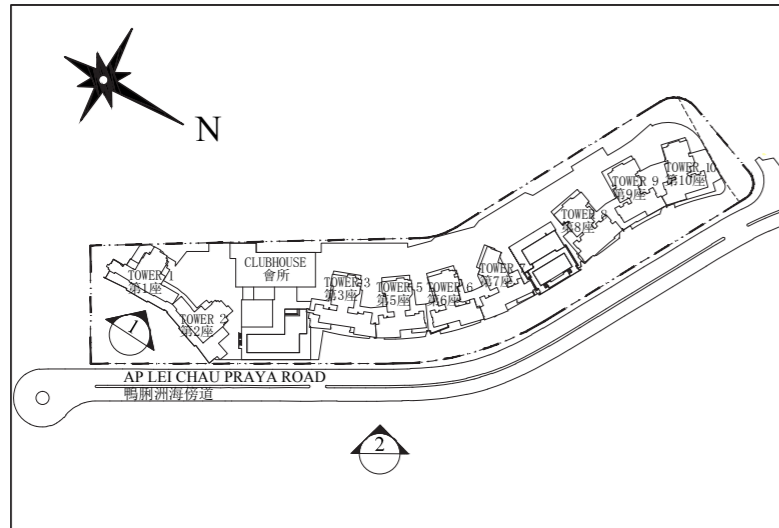

Key Plan 指示圖

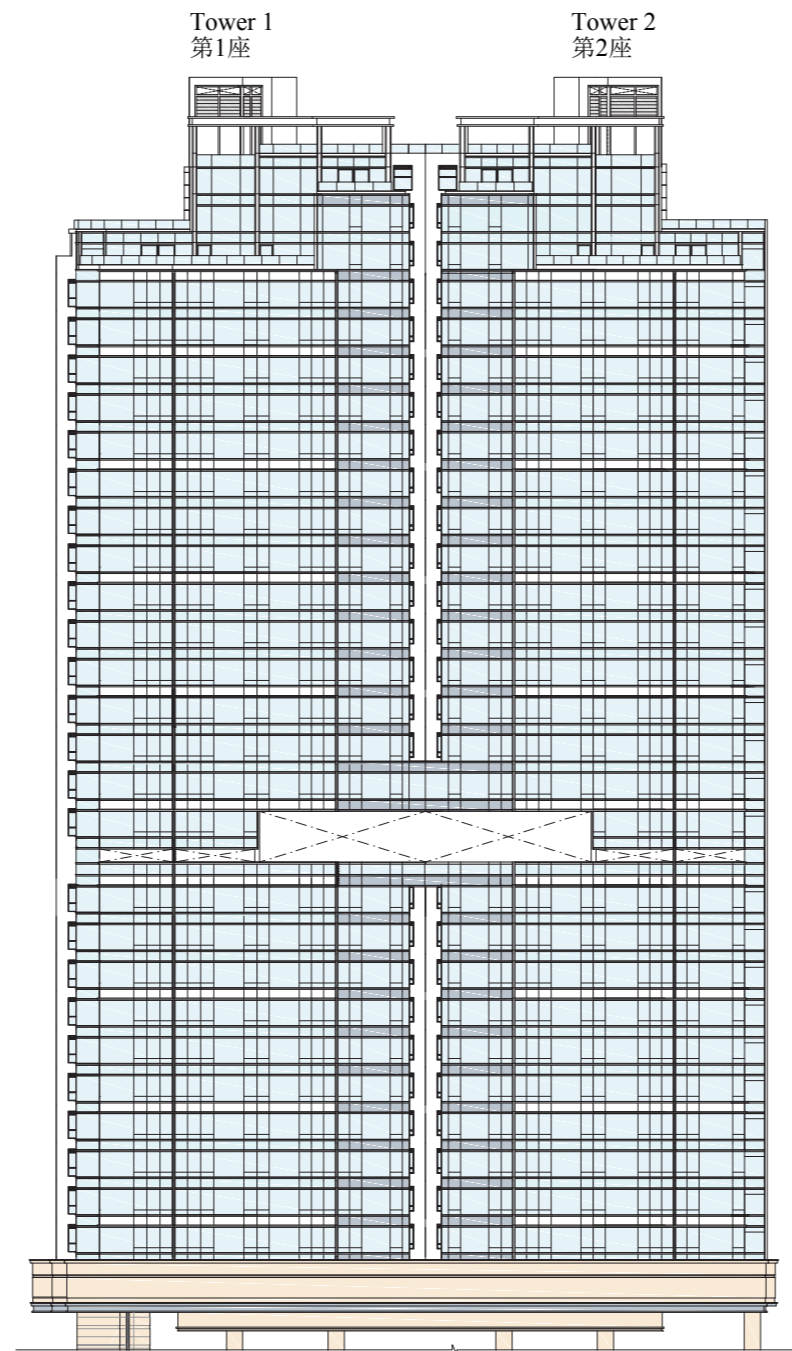

Elevation Plan 1  
立面圖 1

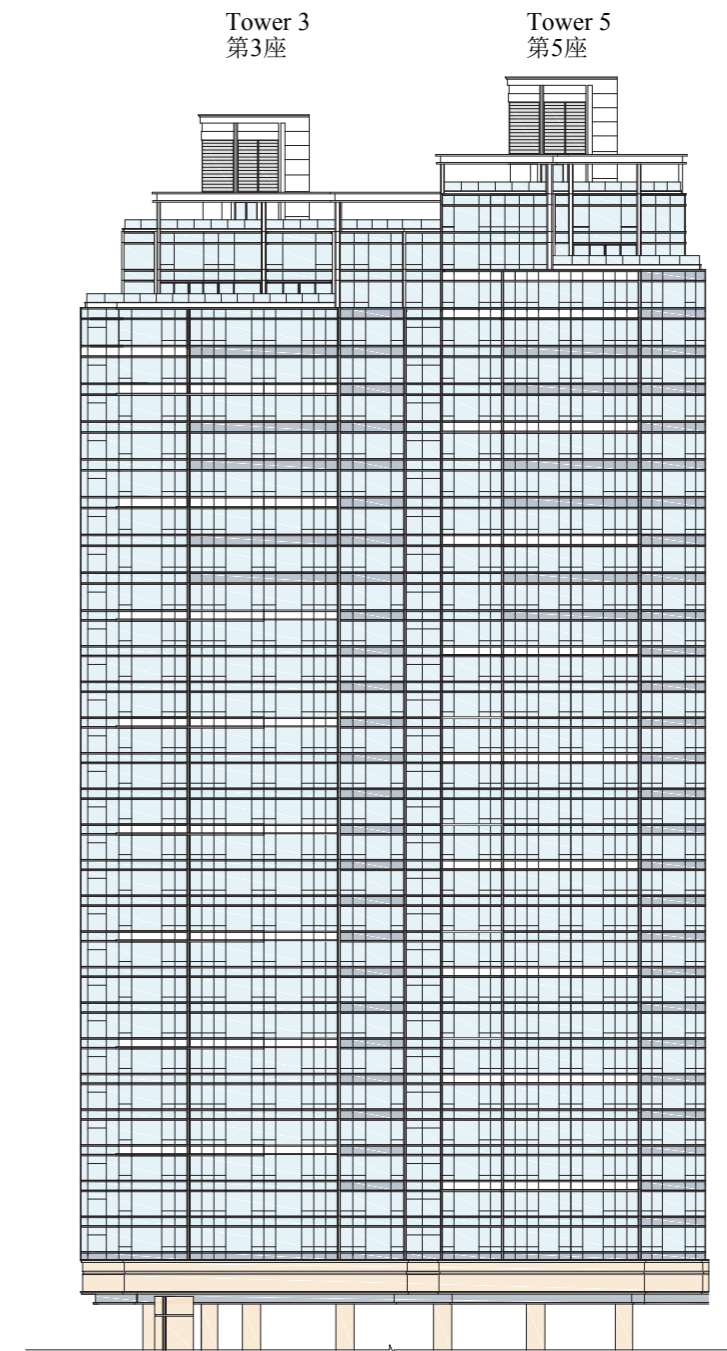

Elevation Plan 2  
立面圖 2

Authorized Person for the Development certified that the elevations shown on this plan:-

- (a) are prepared on the basis of the building plans for the Development approved by Building Authority on 08 October 2010 and 22 November 2010 and
- (b) are in general accordance with the outward appearance of the Development.

發展項目的認可人士證明本圖顯示的立面:-

- (a) 以2010年10月08日及2010年11月22日的情況為準的發展項目的經批准的建築圖則為基礎擬備；及
- (b) 大致上與發展項目外觀一致。



# ELEVATION PLAN FOR THE DEVELOPMENT 發展項目的立面圖

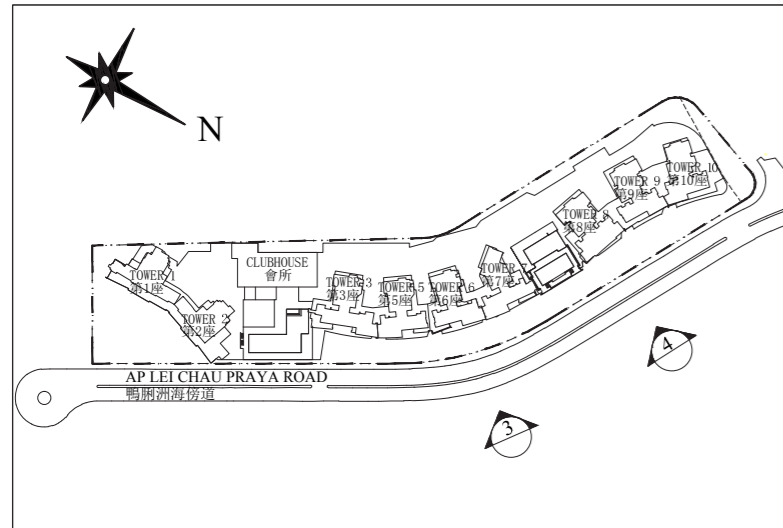

Key Plan 指示圖

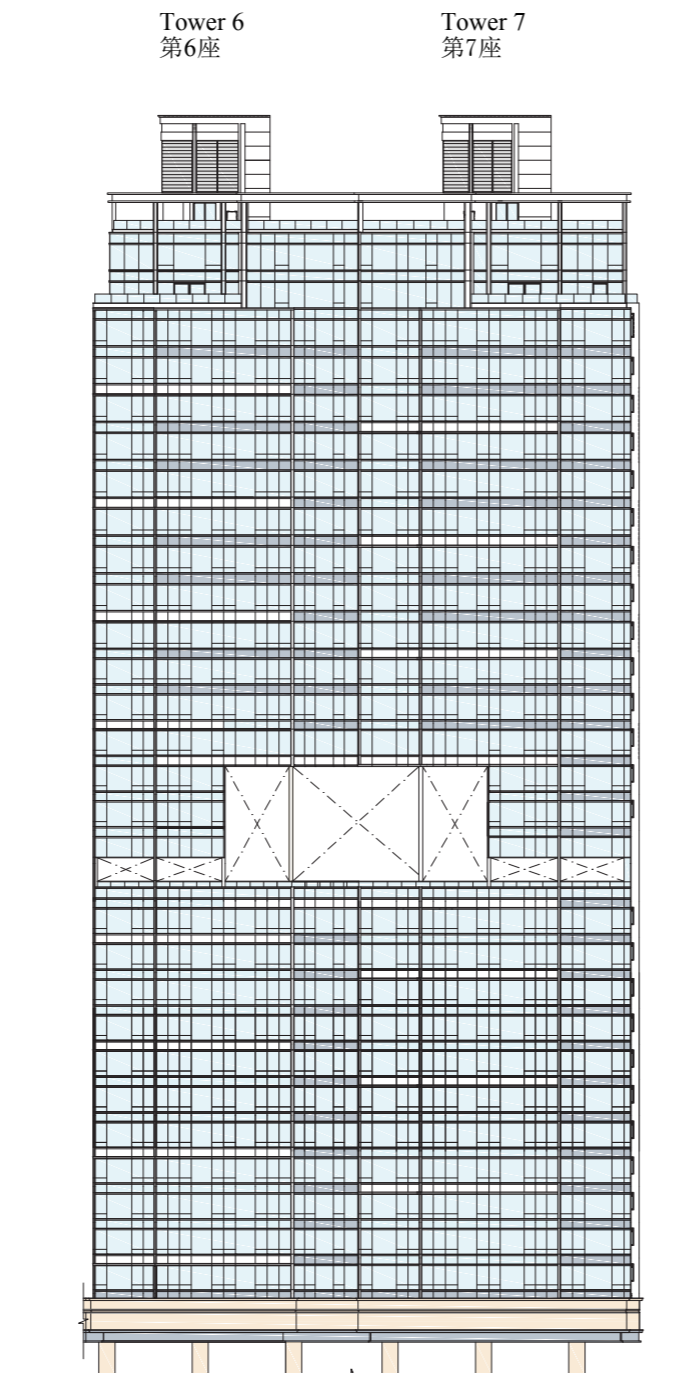

Elevation Plan 3  
立面圖 3

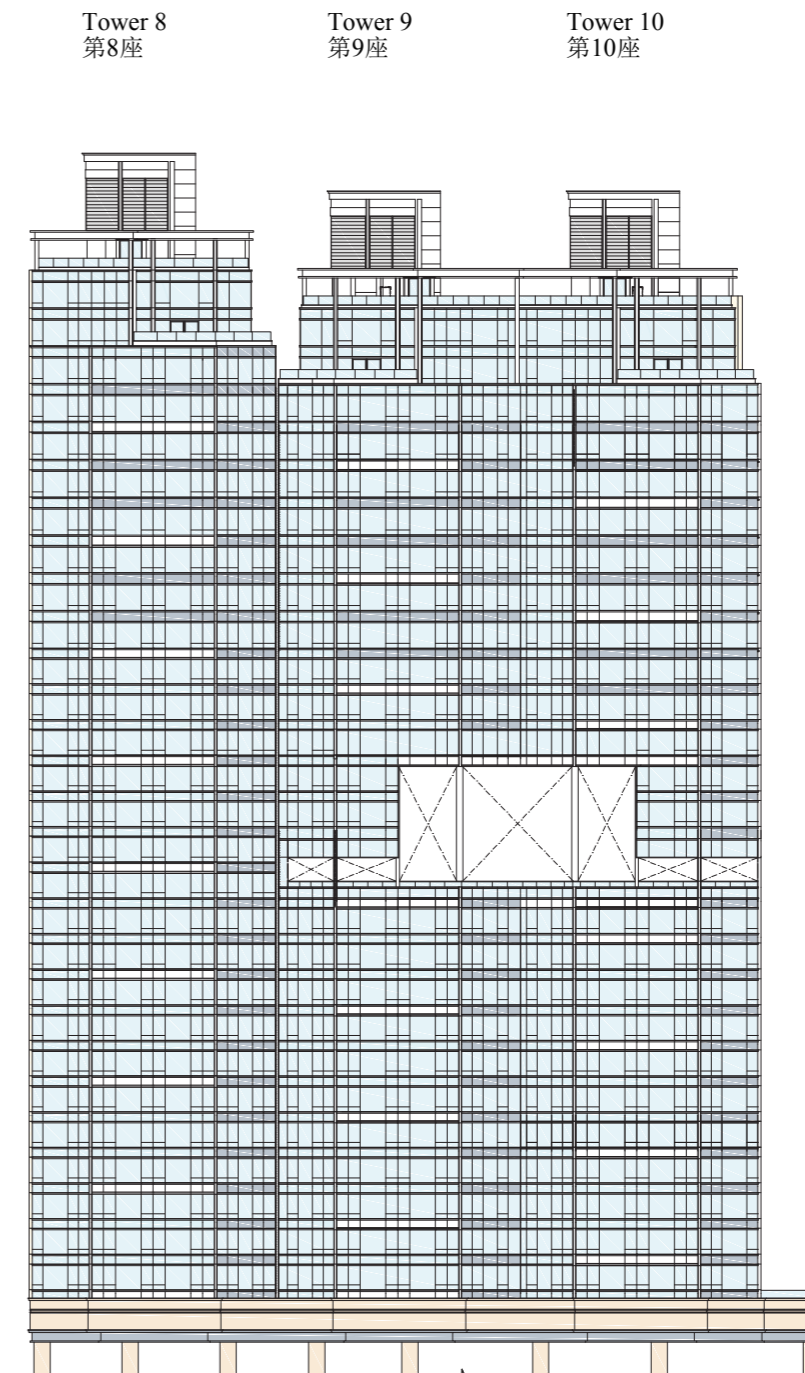

Elevation Plan 4  
立面圖 4

Authorized Person for the Development certified that the elevations shown on this plan:-

- (a) are prepared on the basis of the building plans for the Development approved by Building Authority on 08 October 2010 and 22 November 2010 and
- (b) are in general accordance with the outward appearance of the Development.

發展項目的認可人士證明本圖顯示的立面:-

- (a) 以2010年10月08日及2010年11月22日的情況為準的發展項目的經批准的建築圖則為基礎擬備；及
- (b) 大致上與發展項目外觀一致。

# ELEVATION PLAN FOR THE DEVELOPMENT 發展項目的立面圖

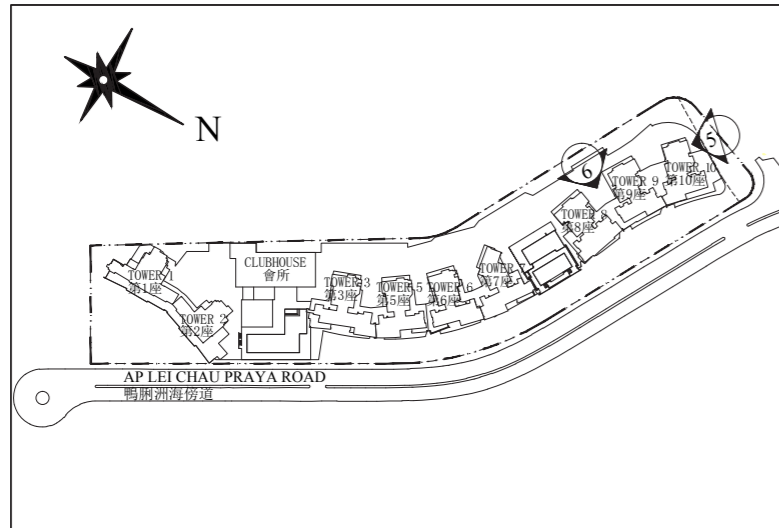

Key Plan 指示圖

Authorized Person for the Development certified that the elevations shown on this plan:-  
 (a) are prepared on the basis of the building plans for the Development approved by Building Authority on 08 October 2010 and 22 November 2010 and  
 (b) are in general accordance with the outward appearance of the Development.

發展項目的認可人士證明本圖顯示的立面:-  
 (a) 以2010年10月08日及2010年11月22日的情況為準的發展項目的經批准的建築圖則為基礎擬備；及  
 (b) 大致上與發展項目外觀一致。

Tower 10  
第10座

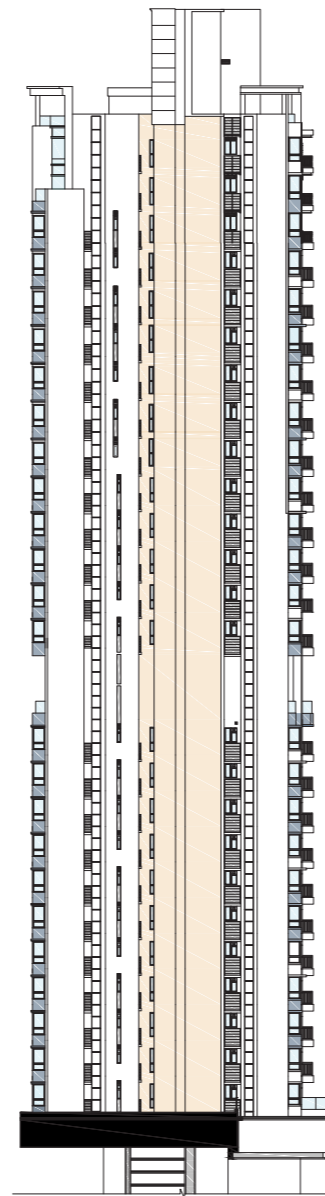

Elevation Plan 5  
立面圖 5

Tower 10  
第10座

Tower 9  
第9座

Tower 8  
第8座

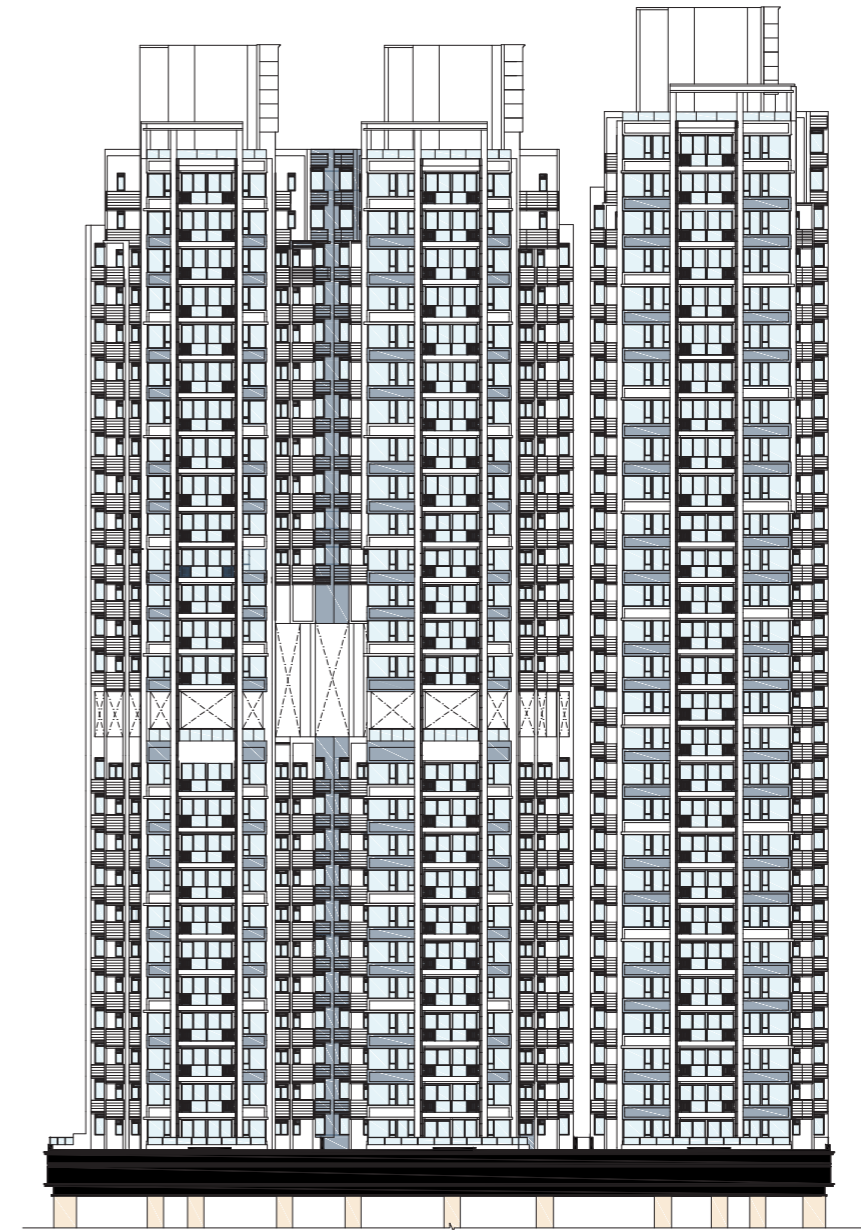

Elevation Plan 6  
立面圖 6

# ELEVATION PLAN FOR THE DEVELOPMENT

## 發展項目的立面圖

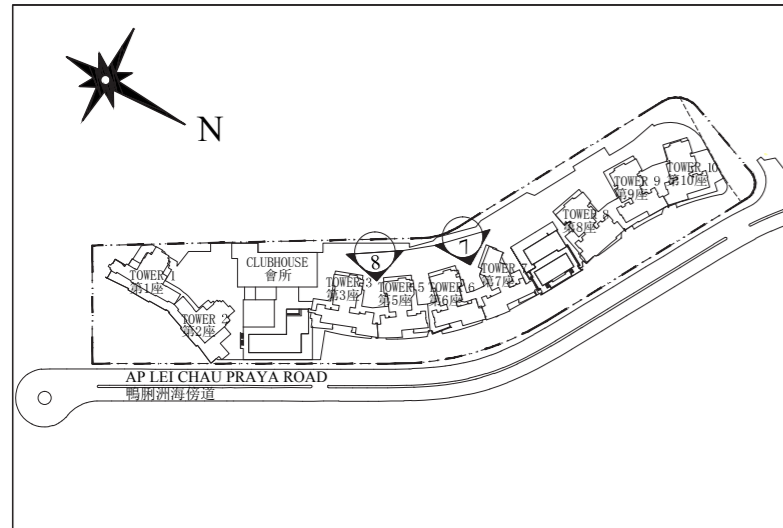

Key Plan 指示圖

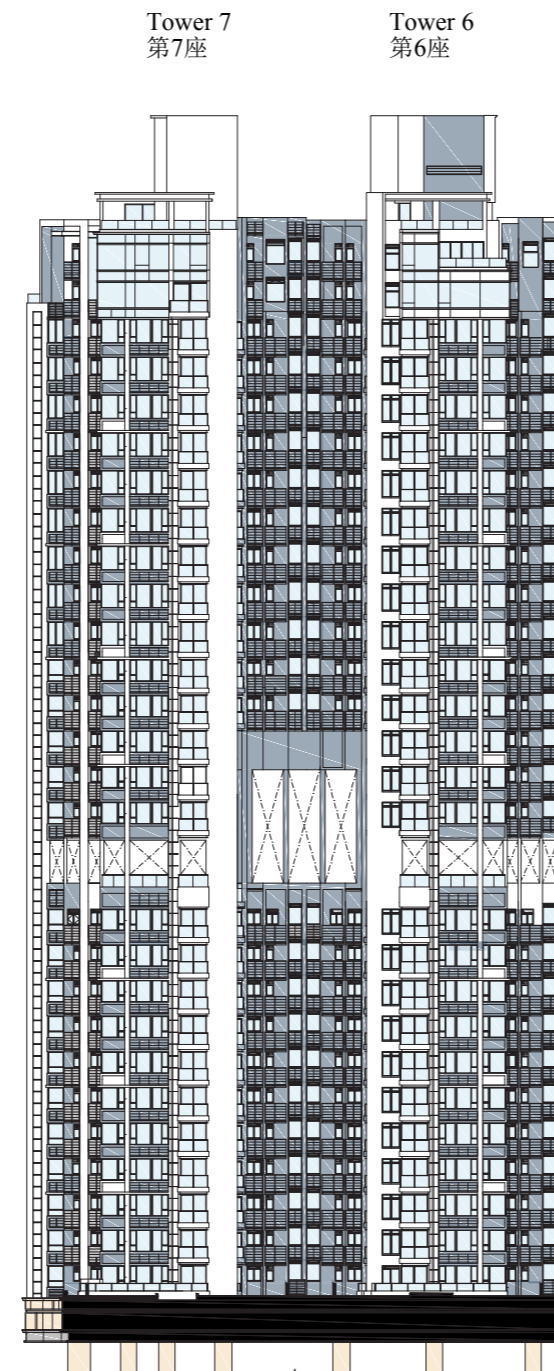

Elevation Plan 7  
立面圖 7

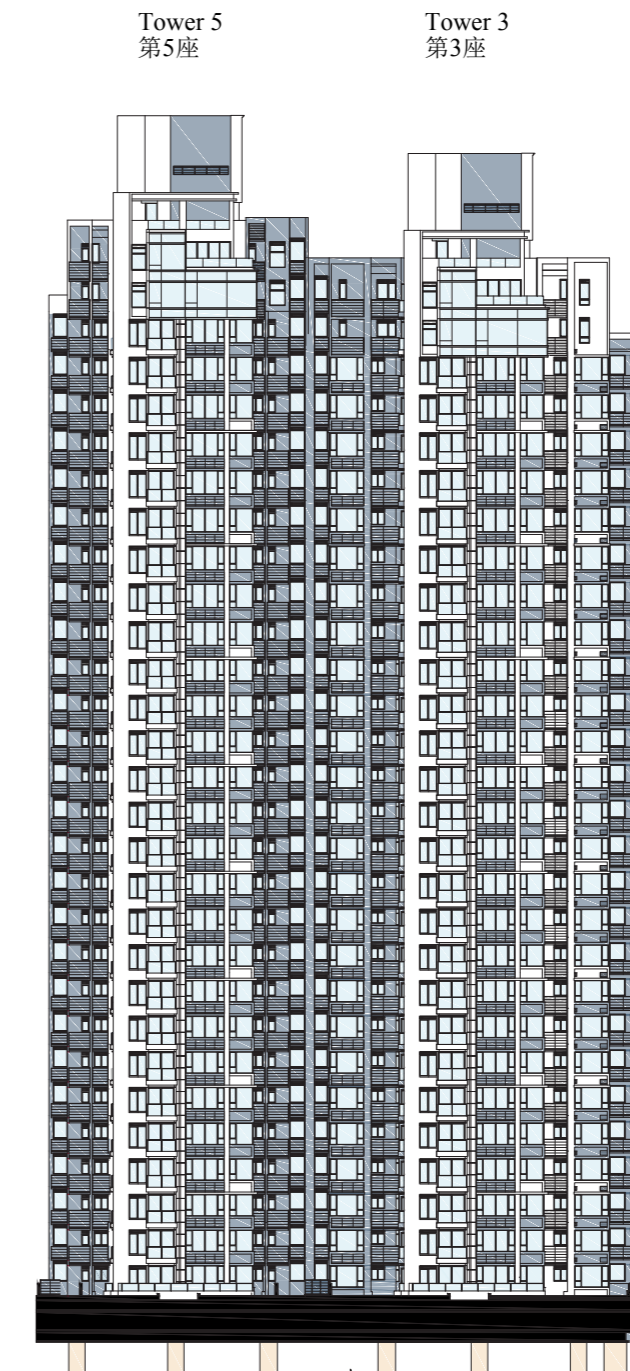

Elevation Plan 8  
立面圖 8

Authorized Person for the Development certified that the elevations shown on this plan:-

- (a) are prepared on the basis of the building plans for the Development approved by Building Authority on 08 October 2010 and 22 November 2010 and
- (b) are in general accordance with the outward appearance of the Development.

發展項目的認可人士證明本圖顯示的立面:-

- (a) 以2010年10月08日及2010年11月22日的情況為準的發展項目的經批准的建築圖則為基礎擬備；及
- (b) 大致上與發展項目外觀一致。

# ELEVATION PLAN FOR THE DEVELOPMENT

## 發展項目的立面圖

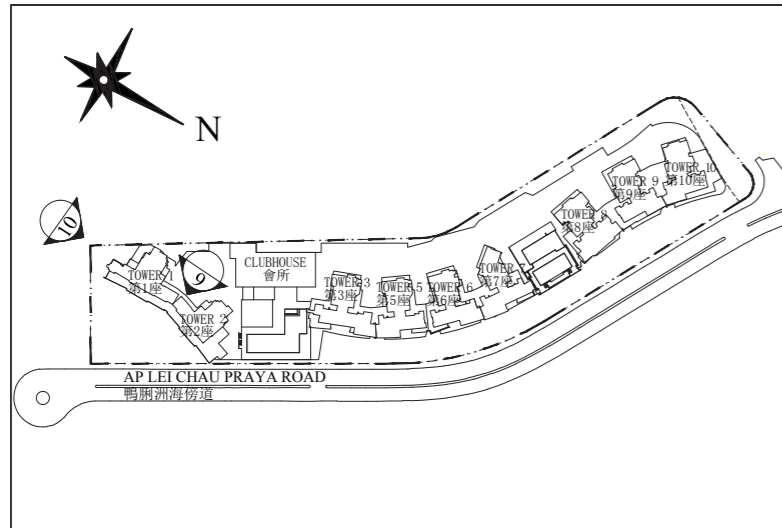

Key Plan 指示圖

Authorized Person for the Development certified that the elevations shown on this plan:-

- (a) are prepared on the basis of the building plans for the Development approved by Building Authority on 08 October 2010 and 22 November 2010 and
- (b) are in general accordance with the outward appearance of the Development.

發展項目的認可人士證明本圖顯示的立面:-

- (a) 以2010年10月08日及2010年11月22日的情況為準的發展項目的經批准的建築圖則為基礎擬備；及
- (b) 大致上與發展項目外觀一致。

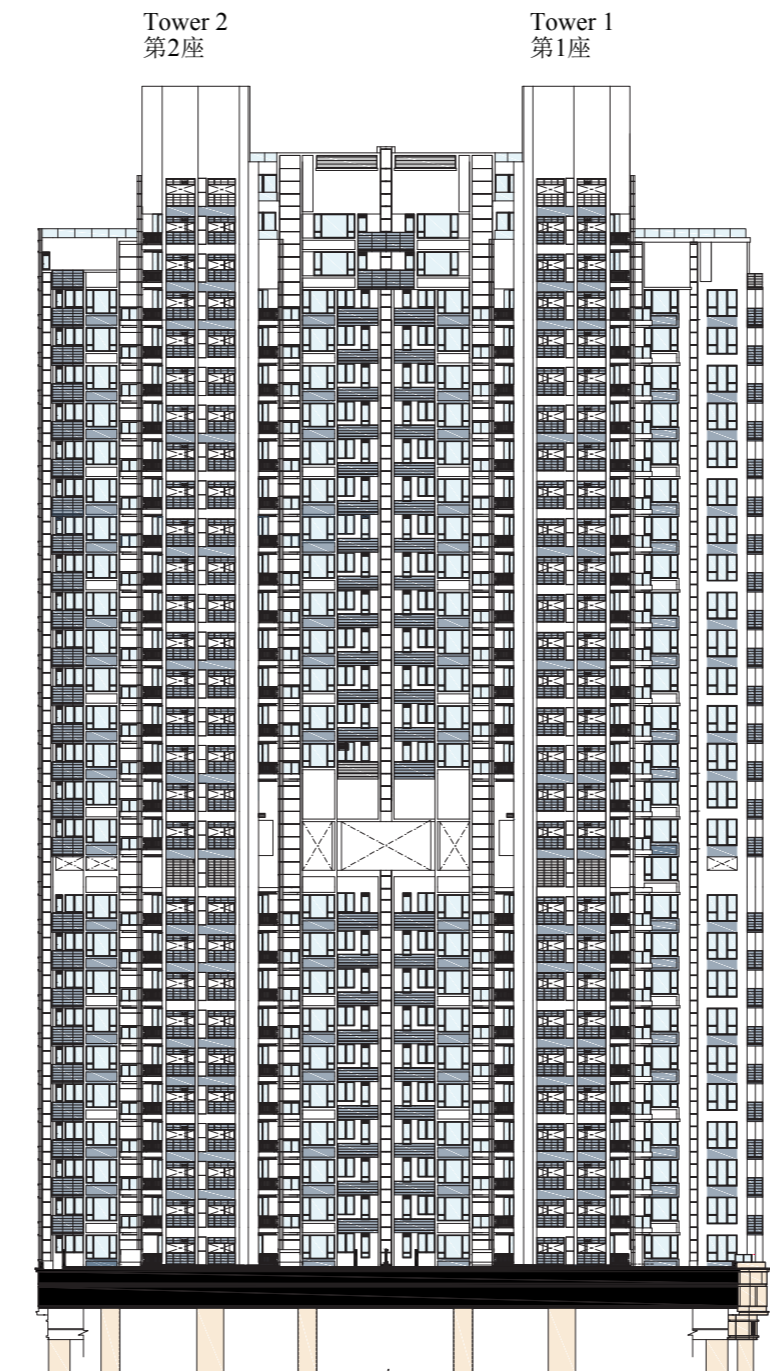

Elevation Plan 9  
立面圖 9



Elevation Plan 10  
立面圖 10

# INFORMATION ON COMMON FACILITIES IN THE DEVELOPMENT

## 發展項目中的公用設施的資料

	Covered 有上蓋遮蓋		Uncovered 無蓋遮蓋		Total Area 總面積	
	sq.m 平方米	sq.ft. 平方呎	sq.m 平方米	sq.ft. 平方呎	sq.m 平方米	sq.ft. 平方呎
Residents' clubhouse (including any recreational facilities for residents' use) 住客會所 (包括供住客使用的任何康樂設施)	4,242.611	45,667	1,192.217	12,833	5,434.828	58,500
Communal garden or play area for residents' use on the roof, or on any floor between the roof and the lowest residential floor, of a building in the Development (whether known as a communal sky garden or otherwise) 位於發展項目中的建築物的天台或在天台和最低一層住宅樓層之間的任何一層的、供住客使用的公用花園或遊樂地方 (不論是稱為公用空中花園或有其他名稱)	1,153.643	12,418	N/A 不適用	N/A 不適用	1,153.643	12,418
Communal garden or play area for residents' use below the lowest residential floor of a building in the Development (whether known as a covered and landscaped play area or otherwise) 位於發展項目中的建築物的最低一層住宅樓層以下的、供住客使用的公用花園或遊樂地方 (不論是稱為有蓋及園景的遊樂場或有其他名稱)	2,917.335	31,402	3,769.754	40,578	6,687.089	71,980

Note: Areas in square feet are converted at a rate of 1 square metre to 10.764 square feet and rounded off to the nearest square foot.  
備註: 以平方呎顯示之面積均依據1平方米=10.764平方呎換算, 並以四捨五入至整數。

# INSPECTION OF PLANS AND DEED OF MUTUAL COVENANT

## 閱覽圖則及公契

1. A copy of the outline zoning plan relating to the Development is available at [www.ozp.tpb.gov.hk](http://www.ozp.tpb.gov.hk).
2. A copy of the deed of mutual covenant in respect of the specified residential property that has been executed is available for inspection at the place at which the specified residential property is offered to be sold.
3. The inspection is free of charge.

1. 備有關乎本發展項目的分區計劃大綱圖的文本供閱覽的互聯網網站的網址為 [www.ozp.tpb.gov.hk](http://www.ozp.tpb.gov.hk)。
2. 指明住宅物業已簽立的公契的文本存放在指明住宅物業的售樓處，以供閱覽。
3. 無須為閱覽付費。

# FITTINGS, FINISHES AND APPLIANCES

## 裝置、裝修物料及設備

### 1. Exterior finishes

	Item	Description
(a)	External wall	External wall of tower: Curtain wall, aluminium cladding, ceramic tiles and louvre.  External wall of podium: Natural stone, aluminium cladding, glass cladding, glass wall, louvre, artificial granite tile and ceramic tiles.
(b)	Window	Aluminium window frame in fluorocarbon coating; tinted glass for living room, dining room, bedroom, kitchen and bathroom (if window is provided and installed).
(c)	Bay window	The material of the bay window is reinforced concrete. Window sill boards finished with natural stone.
(d)	Planter	Finished with natural stone, artificial granite tile and ceramic tiles.
(e)	Verandah or Balcony	Balcony fitted with glass balustrade. Floors finished with natural stone. Walls finished with ceramic tiles. Ceiling finished with aluminium panel.  All balconies are covered.  There is no verandah.
(f)	Drying facilities for clothing	Nil

### 2. Interior finishes

	Item	Description
(a)	Residential Main Entrance Lobby on Ground Floor	Wall: Natural stone, glass panel, mirror panel and timber panel up to the false ceiling. Floor: Natural stone where exposed. Ceiling: Plaster board false ceiling with emulsion painted on exposed surface.
	Lift Lobby of Sky Garden	Wall: Natural stone, glass panel and timber panel up to the false ceiling. Floor: Natural stone where exposed. Ceiling: Plaster board false ceiling with emulsion paint on exposed surface.
	Residential Entrance Lobby on Podium Floor	Wall: Natural stone, veneer, stainless steel panel and glass panel up to false ceiling. (Tower 1 and Tower 2 partial with artificial leather) Floor: Natural stone where exposed. Ceiling: Plaster board false ceiling with emulsion paint on exposed surface.
	Lift Lobby of residential floors	Wall: Natural stone, glass panel, mirror panel, timber panel and plastic laminate panel up to the false ceiling. Floor: Natural stone where exposed. Ceiling: Plaster board false ceiling with emulsion paint on exposed surface.
(b)	Internal wall and ceiling	Wall of Living Room, Dining Room and Bedroom: Plastered and painted with emulsion paint where exposed. Except the following flats: Flat C on 38/F & 39/F of Tower 6: Wall of Living Room and Dining Room: wall paper, feature wall panel, fabric panel, mirror panel and stainless steel strip. Wall of Bedroom: wall paper, fabric panel and stainless steel strip. Flat C on 37/F of Tower 10: Wall of Living Room and Dining Room: wood veneer, feature wall panel, fabric panel, mirror panel and stainless steel strip. Wall of Bedroom : wood veneer, fabric panel, mirror panel and stainless steel strip.  Ceiling of Living Room, Dining Room and Bedroom: Emulsion paint plastered and painted with where exposed. Some areas with plaster board false ceiling and bulkhead in emulsion paint.
(c)	Internal floor	Floor of Living Room and Dining Room: Engineered oak flooring and wooden skirting with reconstituted stone border. Except the following flats: Flat C on 38/F & 39/F of Tower 6: Floor of Living Room and Dining Room: Natural stone floor, no skirting. Flat C on 37/F of Tower 10: Floor of Living Room and Dining Room: Natural stone floor, no skirting.  Floor of Bedroom: Engineered oak flooring and wooden skirting.

# FITTINGS, FINISHES AND APPLIANCES

## 裝置、裝修物料及設備

### 2. Interior finishes

	Item	Description
(c)	Internal floor	Except the following flats: Flat C on 38/F & 39/F of Tower 6: Floor of Bedroom 1: Natural stone flooring, no skirting Floor of Ensuite Bedroom and Master bedroom: Engineered timber flooring , no skirting Flat C on 37/F of Tower 10: Floor of Bedroom : Natural stone floor, no skirting
(d)	Bathroom	Wall: Natural stone and mirror panel where exposed and run up to false ceiling; wall behind vanity cabinet finished with ceramic tile and plastering. Wall behind wall mounted cabinet and mirror cabinet finished with plastering. Floor: Natural stone where exposed. Ceiling: Plaster board false ceiling with emulsion paint and aluminium panel on exposed surface. Except the following flat: Flat C on 37/F of Tower 10: Ceiling: Plaster board false ceiling with emulsion paint on exposed surface.
(e)	Kitchen	Wall: Natural stone and stainless steel panel where exposed and run up to false ceiling. Wall behind kitchen cabinet and refrigerator finished with ceramic tile and plastering.  Floor: Natural stone where exposed. Ceiling: False ceiling finished with plaster board and aluminium panel. Cooking bench finishes: Solid surfacing material.

### 3. Interior fittings

	Item	Description
(a)	Door	<p>Main Entrance Door Timber veneered timber door with timber door frame, timber architrave, concealed over-head door closer, magic eye viewer and lockset.</p> <p>Lift Lobby Door (For Tower 1 and Tower 2) Timber veneered timber door with timber door frame, glass vision panel and handle.</p> <p>Door to staircase (For Tower 1 and Tower 2) Timber door with paint, timber door frame and lockset.</p> <p>Master Bedroom Door, Ensuite Bedroom Door, Bedroom Door and Door for Store not inside Kitchen Timber veneered timber door with timber door frame, timber architrave and lockset. Except the following flats: Flat C on 38/F &amp; 39/F of Tower 6: Bedroom 1: Stainless steel door frame with feature glass sliding door. Flat C on 37/F of Tower 10: Bedroom: Stainless steel door frame with feature glass sliding door.</p> <p>Bathroom Door Timber veneered door with timber door frame, timber architrave and lockset. For the Bathroom without window, doors are equipped with timber louvre. Except the following flats: Flat C on 37/F of Tower 10: Glass door with push bar and pull bar.</p> <p>Kitchen Door Timber veneered door with glass vision panel, timber door frame, timber architrave, door closer and lockset.</p> <p>Door for Store Timber door with timber door frame and lockset. Except the following flats: Flat C on 38/F &amp; 39/F of Tower 6: Store under staircase: Timber door with fabric finishing outside and lockset.</p> <p>Doors to Balcony, Utility Platform and Flat Roof Glass door with fluorocarbon coated aluminum frame and lockset.</p> <p>Door for Lavatory Aluminium door with aluminium door frame and lockset.</p>



# FITTINGS, FINISHES AND APPLIANCES

## 裝置、裝修物料及設備

### 3. Interior fittings

	Item	Description
(b)	Bathroom	<p>Wooden mirror cabinet finished with stainless steel panel, wooden vanity cabinet with natural stone countertop, vitreous china wash basin with chrome plated basin mixer, vitreous china water closet, chrome plated toilet paper holder, chrome plated towel bar, exhaust fan, water heater, lighting fixture and TV is provided in Bathroom in Master Bedroom.</p> <p>Shower cubicle (if any) with tempered glass partition, tempered glass door and chrome plated shower set.</p> <p>Bathtub inside bathroom: For the following flats, cast iron bathtub in size of 1822mm(L) x 914mm(W) x 530mm(H), chrome plated mixer and chrome plated shower set are provided Flat A,B at 7/F to 36/F of Tower 1 and Tower 2, Bathroom in Master Bedroom.</p> <p>For the following flats, cast iron bathtub in size of 1500mm(L) x 800mm(W) x 420mm(H), chrome plated mixer and chrome plated shower set are provided. Flat A,B at 7/F to 36/F of Tower 1, Bathroom Flat A,B at 7/F to 36/F of Tower 2, Bathroom Flat A,B at 7/F to 36/F of Tower 3, Bathroom Flat A,B at 7/F to 37/F of Tower 5, Bathroom in Master Bedroom and Bathroom Flat A,B at 7/F to 37/F of Tower 6, Bathroom in Master Bedroom and Bathroom Flat A,B at 7/F to 37/F of Tower 7, Bathroom in Master Bedroom and Bathroom Flat A,B at 7/F to 36/F of Tower 8, Bathroom in Master Bedroom Flat A,B at 7/F to 35/F of Tower 9, Bathroom in Master Bedroom Flat A,B at 7/F to 35/F of Tower 10, Bathroom in Master Bedroom</p> <p>For the following flats, cast iron bathtub in size of 1600mm(L) x 800mm(W) x 420mm(H), chrome plated mixer and chrome plated shower set are provided. Flat A,B at 7/F to 36/F of Tower 3, Bathroom in Master Bedroom Flat A at 38/F to 39/F of Tower 5, Bathroom in Ensuite Bedroom Flat A at 38/F to 39/F of Tower 6, Bathroom in Ensuite Bedroom Flat A at 38/F to 39/F of Tower 7, Bathroom in Ensuite Bedroom</p>

	Item	Description
(b)	Bathroom	<p>For the following flats, cast iron bathtub in size of 1524mm(L) x 768mm(W) x 355mm(H), chrome plated mixer and chrome plated shower set are provided. Flat C at 7/F to 36/F of Tower 3, Bathroom in Master Bedroom Flat C at 7/F to 37/F of Tower 5, Bathroom in Master Bedroom Flat C at 7/F to 37/F of Tower 6, Bathroom in Master Bedroom Flat C at 7/F to 37/F of Tower 7, Bathroom in Master Bedroom Flat C,D at 7/F to 38/F of Tower 8, Bathroom in Master Bedroom Flat C at 7/F to 37/F of Tower 9, Bathroom in Master Bedroom Flat D at 7/F to 37/F of Tower 9, Bathroom Flat C,D at 7/F to 37/F of Tower 10, Bathroom</p> <p>For the following flats, cast iron bathtub in size of 1676mm(L) x 914mm(W) x 610mm(H), chrome plated mixer and chrome plated shower set are provided. Flat A at 37/F and 39/F(Upper Duplex) of Tower 1, Bathroom in Master Bedroom Flat A at 39/F(Upper Duplex) of Tower 2, Bathroom in Master Bedroom</p> <p>For the following flats, cast iron bathtub in size of 1676mm(L) x 914mm(W) x 584mm(H), chrome plated mixer and chrome plated shower set are provided. Flat A at 37/F of Tower 2, Bathroom in Master Bedroom Flat A at 37/F and 38/F of Tower 3, Bathroom in Master Bedroom</p> <p>For the following flats, cast iron bathtub in size of 1524mm(L) x 813mm(W) x 464mm(H), chrome plated mixer and chrome plated shower set are provided. Flat C at 38/F (Upper Duplex) of Tower 3, Bathroom in Master Bedroom Flat C at 39/F (Upper Duplex) of Tower 5, Bathroom in Master Bedroom Flat C at 39/F (Upper Duplex) of Tower 6, Bathroom in Master Bedroom Flat C at 39/F (Upper Duplex) of Tower 7, Bathroom in Master Bedroom Flat A at 38/F and 39/F of Tower 5, Bathroom in Master Bedroom Flat A at 38/F and 39/F of Tower 6, Bathroom in Master Bedroom Flat A at 38/F and 39/F of Tower 7, Bathroom in Master Bedroom Flat A at 37/F and 38/F of Tower 8, Bathroom in Master Bedroom Flat A at 36/F and 37/F of Tower 9, Bathroom in Master Bedroom Flat A at 36/F and 37/F of Tower 10, Bathroom in Master Bedroom</p> <p>For type and material of water supply system, please refer to “3.(j) Water Supply”.</p> <p>For brand name and model number of appliances, please refer to “Appliances Schedule”.</p>

# FITTINGS, FINISHES AND APPLIANCES

## 裝置、裝修物料及設備

### 3. Interior fittings

	Item	Description
(c)	Kitchen	<p>Stainless-steel sink, chrome plated hot and cold water sink mixer. Wooden kitchen cabinet with acrylic coated door panel and aluminium handle. Solid surfacing material counter top. Built-in gas cooking hob, cooker hood, microwave oven, electric oven, built-in refrigerator, washer and dryer, wine cellar, exhaust fan and lighting fixture.</p> <p>For type and material of water supply system, please refer to “3.(j) Water Supply”.</p> <p>For brand name and model number of appliances, please refer to “Appliances Schedule”.</p>
(d)	Bedroom	No fittings.
(e)	Telephone	<p>Telephone connection points are provided in living room, master bedroom and bedroom.</p> <p>For the location and number of connection points, please refer to “Schedule of Mechanical &amp; Electrical Provisions”.</p>
(f)	Aerials	<p>TV/FM outlets for local TV/FM programs are provided in living room, master bedroom, ensuite bedroom, bedroom and store not inside kitchen.</p> <p>For the location and number of connection points, please refer to “Schedule of Mechanical &amp; Electrical Provisions”.</p>
(g)	Electrical installations	<p>Electrical supply with miniature circuit breakers distribution board is provided. Concealed and exposed conduit wiring for lightings and power points are provided.</p> <p>Conduits are partly concealed and partly exposed. <sup>1</sup></p> <p>For the location and number of socket points and air conditioner points, please refer to “Schedule of Mechanical &amp; Electrical Provisions”.</p>
(h)	Gas supply	Town gas supply pipes are installed at kitchen and connected to gas cooking hob.
(i)	Washing machine connection point	Washing machine connection point is located in the kitchen/store. Water point of a design of 22mm in diameter and drain point of a design of 40mm in diameter for washing machine are provided.

	Item	Description
(j)	Water supply	<p>Copper pipes for hot and cold water supply. uPVC pipes are used for flushing water supply system.</p> <p>Water pipes are partly concealed and partly exposed.<sup>2</sup></p> <p>Hot water supply is available.</p>

#### Remarks:

- Other than those parts of the conduits concealed within concrete, the rest of them are exposed. The exposed conduits may be covered or hidden by false ceilings, bulkheads, cabinets, claddings non-concrete partition walls, designated pipe ducts or other materials.
- Other than those parts of the water pipes concealed within concrete, the rest of them are exposed. The exposed water pipes may be covered or hidden by false ceilings, bulkheads, cabinets, claddings non-concrete partition walls, designated pipe ducts or other materials.

# FITTINGS, FINISHES AND APPLIANCES

## 裝置、裝修物料及設備

### 4. Miscellaneous

	Item	Description
(a)	Lifts	<p>Towers: 2 nos. of “TOSHIBA” passenger lifts serving the following floors each residential towers:</p> <p>Lift no.1 of Tower 1 (Model no. ELBRIGHT (CL-300W)): 1/F, 5/F, 7/F-12/F, 15/F-18/F, Refuge Floor/Sky Garden, 20/F-23/F, 25/F-33/F and 35/F-37/F</p> <p>Lift no.2 of Tower 1 (Model no. ELBRIGHT (CL-300W)): 1/F, 5/F, 7/F-12/F, 15/F-18/F, Refuge Floor/Sky Garden, 22/F-23/F, 25/F-33/F and 35/F-38/F</p> <p>Lift no.4 of Tower 2 (Model no. ELBRIGHT (CL-300W)): 1/F, 5/F, 7/F-12/F, 15/F-18/F, Refuge Floor/Sky Garden, 20/F-23/F, 25/F-33/F and 35/F-37/F</p> <p>Lift no.5 of Tower 2 (Model no. ELBRIGHT (CL-300W)): 1/F, 5/F, 7/F-12/F, 15/F-18/F, Refuge Floor/Sky Garden, 22/F-23/F, 25/F-33/F and 35/F-38/F</p> <p>Lift no.8 and no.9 of Tower 3 (Model no. ELBRIGHT (CL-300W)): 1/F, 3/F, 5/F-6/F, Podium Floor, 7/F-12/F, 15/F-23/F, 25/F-33/F and 35/F-38/F</p> <p>Lift no.11 and no.12 of Tower 5 (Model no. ELBRIGHT (CL-300W)): G/F, 1/F, 3/F, 5/F-6/F, Podium Floor, 7/F-12/F, 15/F-23/F, 25/F-33/F and 35/F-39/F</p> <p>Lift no.14 and no.15 of Tower 6 (Model no. ELBRIGHT (CL-300W)): G/F, 1/F, 3/F, 5/F-6/F, Podium Floor, 7/F-12/F, 15/F-19/F, Refuge Floor/Sky Garden, 22/F-23/F, 25/F-33/F and 35/F-39/F</p> <p>Lift no.17 and no.18 of Tower 7 (Model no. ELBRIGHT (CL-300W)): G/F, 1/F, 3/F, 5/F-6/F, Podium Floor, 7/F-12/F, 15/F-19/F, Refuge Floor/Sky Garden, 22/F-23/F, 25/F-33/F and 35/F-39/F</p> <p>Lift no.20 and no.21 of Tower 8 (Model no. ELBRIGHT (CL-300W)): G/F, 1/F, 3/F, 5/F-6/F, Podium Floor, 7/F-12/F, 15/F-23/F, 25/F-33/F and 35/F-38/F</p>

	Item	Description
(a)	Lifts	<p>Lift no.23 and no.24 of Tower 9 (Model no. ELBRIGHT (CL-300W)): G/F, 1/F, 3/F, 5/F-6/F, Podium Floor, 7/F-12/F, 15/F-19/F, Refuge Floor/Sky Garden, 22/F-23/F, 25/F-33/F and 35/F-37/F</p> <p>Lift no.26 and no.27 of Tower 10 (Model no. ELBRIGHT (CL-300W)): G/F, 1/F, 5/F-6/F, Podium Floor, 7/F-12/F, 15/F-19/F, Refuge Floor/Sky Garden, 22/F-23/F, 25/F-33/F and 35/F-37/F</p> <p>1 nos. of “TOSHIBA” Fireman’s lifts serving the following floors each residential towers:</p> <p>Fireman’s Lift no.3 of Tower 1 (Model no. ELBRIGHT (CL-300W)): The lift door that facing Flat A serving the following floors: 1/F, 5/F, 7/F-12/F, 15/F-18/F, Refuge Floor/Sky Garden, 20/F-23/F, 25/F-33/F and 35/F-36/F</p> <p>The lift door that facing Flat B serving the following floors: 1/F, 3/F, 5/F, 7/F-12/F, 15/F-18/F, Refuge Floor/Sky Garden, 22/F-23/F, 25/F-33/F and 35/F-38/F</p> <p>Fireman’s Lift no.6 of Tower 2 (Model no. ELBRIGHT (CL-300W)): The lift door that facing Flat A serving the following floors: 1/F, 5/F, 7/F-12/F, 15/F-18/F, Refuge Floor/Sky Garden, 20/F-23/F, 25/F-33/F and 35/F-36/F</p> <p>The lift door that facing Flat B serving the following floors: 1/F-3/F, 5/F, 7/F-12/F, 15/F-18/F, Refuge Floor/Sky Garden, 22/F-23/F, 25/F-33/F and 35/F-38/F</p> <p>Fireman’s Lift no.7 of Tower 3 (Model no. ELBRIGHT (CL-300W)): 1/F, 3/F, 5/F-6/F, Podium Floor, 7/F-12/F, 15/F-23/F, 25/F-33/F and 35/F-38/F</p> <p>Fireman’s Lift no.10 of Tower 5 (Model no. ELBRIGHT (CL-300W)): G/F, 1/F, 3/F, 5/F-6/F, Podium Floor, 7/F-12/F, 15/F-23/F, 25/F-33/F and 35/F-39/F</p> <p>Fireman’s Lift no.13 of Tower 6 (Model no. ELBRIGHT (CL-300W)): G/F, 1/F, 3/F, 5/F-6/F, Podium Floor, 7/F-12/F, 15/F-19/F, Refuge Floor/Sky Garden, 22/F-23/F, 25/F-33/F and 35/F-39/F</p> <p>Fireman’s Lift no.16 of Tower 7 (Model no. ELBRIGHT (CL-300W)): G/F, 1/F, 3/F, 5/F-6/F, Podium Floor, 7/F-12/F, 15/F-19/F, Refuge Floor/Sky Garden, 22/F-23/F, 25/F-33/F and 35/F-39/F</p>

# FITTINGS, FINISHES AND APPLIANCES

## 裝置、裝修物料及設備

### 4. Miscellaneous

	Item	Description
(a)	Lifts	<p>Fireman's Lift no.19 of Tower 8 (Model no. ELBRIGHT (CL-300W)): G/F, 1/F, 3/F, 5/F-6/F, Podium Floor, 7/F-12/F, 15/F-23/F, 25/F-33/F and 35/F-38/F</p> <p>Fireman's Lift no.22 of Tower 9 (Model no. ELBRIGHT (CL-300W)): G/F, 1/F, 3/F, 5/F-6/F, Podium Floor, 7/F-12/F, 15/F-19/F, Refuge Floor/Sky Garden, 22/F-23/F, 25/F-33/F and 35/F-37/F</p> <p>Fireman's Lift no.25 of Tower 10 (Model no. ELBRIGHT (CL-300W)): G/F, 1/F, 5/F-6/F, Podium Floor, 7/F-12/F, 15/F-19/F, Refuge Floor/Sky Garden, 22/F-23/F, 25/F-33/F and 35/F-37/F</p> <p>Podium: 5 nos. of "TOSHIBA" Passenger lifts (Model no. SPACEL-UNI (CV300)) serving G/F to 1/F.</p> <p>Clubhouse : 4 nos. of "TOSHIBA" Passenger lifts (Model no. SPACEL-UNI (CV300)) serving Clubhouse floors.</p>
(b)	Letter box	Stainless steel letter box.
(c)	Refuse collection	<p>Tower 1 and Tower 2: Each residential floor has refuse chute; refuse will be collected by cleaners on G/F refuse chute and centralized to the refuse storage and material recovery chamber on G/F and to be removed by refuse vehicle.</p> <p>Tower 3, Tower 5 to Tower 10: Refuse will be collected by cleaners from common rubbish bin on each residential floor and centralized at refuse storage and material recovery chamber on G/F for removal by refuse vehicle.</p>
(d)	Water meter, electricity meter and gas meter	<p>Separate water meter for each flat provided at Water Meter Duct on residential floors.</p> <p>Separate electricity meter for each flat provided at Electricity Meter Room on residential floors.</p> <p>Tower 1 and Tower 2: Location for the installation of separate gas meter reserved inside air-conditioning plant room of each flat.</p> <p>Tower 3, Tower 5 to Tower 10: Location for the installation of separate gas meter reserved inside kitchen of each flat. Except the following flat: Flat C on 38/F of Tower 6: Location for the installation of separate gas meter reserved inside store.</p>

### 5. Security facilities

Item	Description
Security System and Equipment	<p>CCTV cameras are provided at entrances of the development, main entrance lobby on G/F, tower lift lobbies on 3/F, lift cars, carpark entrance, carpark and clubhouse, and connect to the caretaker's office.</p> <p>Visitor intercom panel with smart card reader for access control are provided at main entrance lobby on G/F and tower lift lobbies on 3/F, and connect to video door phone of each flat. Video door phone is provided in each flat.</p>

The vendor undertakes that if lifts or appliances of the specified brand name or model number are not installed in the development, lifts or appliances of comparable quality will be installed.

# FITTINGS, FINISHES AND APPLIANCES

## 裝置、裝修物料及設備

### 1. 外部裝修物料

	細項	描述
(a)	外牆	住宅大樓外牆： 玻璃幕牆、鋁板、瓷磚及百葉。  平台外牆： 天然石材、鋁板、玻璃蓋板、玻璃牆、百葉、仿石外牆磚及瓷磚。
(b)	窗	氟化碳噴塗鋁窗框；客廳、飯廳、睡房、廚房及浴室(如有窗)窗戶配顏色玻璃。
(c)	窗台	窗台的用料為鋼混凝土。 窗台面鋪砌天然石材。
(d)	花槽	鋪砌天然石材、仿石外牆磚及瓷磚。
(e)	陽台或露台	露台裝有玻璃欄河，地台鋪天然石材，牆身鋪砌瓷磚，天花裝配鋁板。  所有露台設有上蓋。  沒有陽台。
(f)	乾衣設施	沒有。

### 2. 室內裝修物料

	細項	描述
(a)	地下住宅入口大堂	牆壁：天然石材、玻璃板、鏡板及木材板至假天花。 地板：外露位置鋪砌天然石材。 天花板：石膏板假天花外露位置髹乳膠漆。
	空中花園大堂	牆壁：天然石材、玻璃板及木材板至假天花。 地板：外露位置鋪砌天然石材。 天花板：石膏板假天花外露位置髹乳膠漆。
	平台住宅入口大堂	牆壁：天然石材、木皮、不鏽鋼板及玻璃板至假天花。(第1座及第2座部份鋪砌人造皮) 地板：外露位置鋪砌天然石材。 天花板：石膏板假天花外露位置髹乳膠漆。
	住宅層升降機大堂	牆壁：天然石材、玻璃板、鏡板、木材板及膠板至假天花。 地板：外露位置鋪砌天然石材。 天花板：石膏板假天花外露位置髹乳膠漆。
(b)	內牆及天花板	客廳、飯廳及睡房牆壁：外露位置批盪後髹乳膠漆。 除以下單位： 第6座38樓及39樓C單位： 客廳及飯廳牆身：牆紙、裝飾牆板、布飾面板、鏡板及不鏽鋼條。 睡房牆身：牆紙、布飾面板及不鏽鋼條。 第10座37樓C單位： 客廳及飯廳牆身：木皮面、裝飾牆板、布飾面板、鏡板及不鏽鋼條。 睡房牆身：木皮面、布飾面板、鏡板及不鏽鋼條。  客廳、飯廳及睡房天花：外露位置批盪後髹乳膠漆。部份地方設有髹乳膠漆之石膏板假天花及假陣。
(c)	內部地板	客廳及飯廳地板：複合橡木地板及木牆腳線配合成石材邊界。 除以下單位： 第6座38樓及39樓C單位： 客廳及飯廳地板：天然石地台、無腳線。 第10座37樓C單位： 客廳及飯廳地板：天然石地台、無腳線。  睡房地板：複合橡木地板及木牆腳線。 除以下單位： 第6座38樓及39樓C單位： 睡房1地板：天然石地台、無腳線。 套房及主人房地板：複合木地板、無腳線。 第10座37樓C單位： 睡房地板：天然石地台、無腳線。

# FITTINGS, FINISHES AND APPLIANCES

## 裝置、裝修物料及設備

### 2. 室內裝修物料

	細項	描述
(d)	浴室	<p>牆身：外露位置鋪砌天然石材及鏡板至假天花。面盆櫃背牆身鋪砌瓷磚及水泥批盪；掛牆櫃背及鏡櫃背牆為水泥批盪。</p> <p>地板：外露位置鋪砌天然石材。</p> <p>天花板：外露位置設置石膏板假天花髹乳膠漆及鋁板。</p> <p>除以下單位： 第10座37樓C單位： 天花板：外露位置設置石膏板假天花髹乳膠漆。</p>
(e)	廚房	<p>牆身：外露位置鋪砌天然石材及不鏽鋼板至假天花。廚櫃及雪櫃背之牆身鋪砌瓷磚及水泥批盪。</p> <p>地板：外露位置鋪砌天然石材。</p> <p>天花板：假天花以石膏板及鋁板鋪砌。</p> <p>灶台物料：實體面材。</p>

### 3. 室內裝置

	細項	描述
(a)	門	<p>入口大門 木皮飾面木門配木門框、木封口線、嵌入式門氣鼓、防盜眼及門鎖。</p> <p>電梯大堂門(第1座及第2座) 木皮飾面木門配木門框、玻璃視窗及把手。</p> <p>通往樓梯的門(第1座及第2座) 木門髹油漆、木門框及門鎖。</p> <p>主人房門、套房門、睡房門及非廚房內士多房門 木皮飾面木門配木門框、木封口線及門鎖。 除以下單位： 第6座38樓及39樓C單位： 睡房1：不銹鋼門框配裝飾玻璃趟門。 第10座37樓C單位： 睡房：不銹鋼門框配裝飾玻璃趟門。</p> <p>浴室門 木皮飾面木門配木門框、木封口線及門鎖。 不設窗戶之浴室，門上設有木百葉。 除以下單位： 第10座37樓C單位：玻璃門配推把手及拉把手。</p> <p>廚房門 木皮飾面木門配玻璃視窗、木門框、木封口線、門氣鼓及門鎖。</p> <p>士多房門 木門配木門框及門鎖。 除以下單位： 第6座38樓及39樓C單位： 樓梯底的士多房：木門配布面外飾面及門鎖。</p> <p>門通往露台、工作平台及平台 玻璃門配以氟化碳噴塗鋁框及門鎖。</p> <p>洗手間門 鋁質門配鋁質門框及門鎖。</p>

# FITTINGS, FINISHES AND APPLIANCES

## 裝置、裝修物料及設備

### 3. 室內裝置

	細項	描述
(b)	浴室	<p>木製鏡櫃配不鏽鋼板，木製面盆櫃連天然石材檯面、搪瓷洗面盆配鍍鉻水龍頭，搪瓷坐廁，鍍鉻廁紙架、鍍鉻毛巾棍、抽氣扇、熱水爐、燈飾及主人房內之浴室配置電視。</p> <p>淋浴間(如有)配強化玻璃間隔、強化玻璃門及鍍鉻花灑套裝。</p> <p>浴室浴缸: 以下單位裝設1822毫米(長)x914毫米(寬)x530毫米(高)搪瓷鑄鐵浴缸配鍍鉻浴缸水龍頭及鍍鉻花灑套裝。 第1座及第2座7樓至36樓A,B單位主人房內之浴室</p> <p>以下單位裝設1500毫米(長)x800毫米(寬)x420毫米(高)搪瓷鑄鐵浴缸配鍍鉻浴缸水龍頭及鍍鉻花灑套裝。 第1座7樓至36樓A,B單位之浴室 第2座7樓至36樓A,B單位之浴室 第3座7樓至36樓A,B單位之浴室 第5座7樓至37樓A,B單位主人房內之浴室及浴室 第6座7樓至37樓A,B單位主人房內之浴室及浴室 第7座7樓至37樓A,B單位主人房內之浴室及浴室 第8座7樓至36樓A,B單位主人房內之浴室 第9座7樓至35樓A,B單位主人房內之浴室 第10座7樓至35樓A,B單位主人房內之浴室</p> <p>以下單位裝設1600毫米(長)x800毫米(寬)x420毫米(高)搪瓷鑄鐵浴缸配鍍鉻浴缸水龍頭及鍍鉻花灑套裝。 第3座7樓至36樓A,B單位主人房內之浴室 第5座38樓至39樓A單位套房內之浴室 第6座38樓至39樓A單位套房內之浴室 第7座38樓至39樓A單位套房內之浴室</p> <p>以下單位裝設1524毫米(長)x768毫米(寬)x355毫米(高)搪瓷鑄鐵浴缸配鍍鉻浴缸水龍頭及鍍鉻花灑套裝。 第3座7樓至36樓C單位主人房內之浴室 第5座7樓至37樓C單位主人房內之浴室 第6座7樓至37樓C單位主人房內之浴室 第7座7樓至37樓C單位主人房內之浴室 第8座7樓至38樓C,D單位主人房內之浴室 第9座7樓至37樓C單位主人房內之浴室 第9座7樓至37樓D單位之浴室 第10座7樓至37樓C,D單位之浴室</p>

	細項	描述
(b)	浴室	<p>以下單位裝設1676毫米(長)x914毫米(寬)x610毫米(高)搪瓷鑄鐵浴缸配鍍鉻浴缸水龍頭及鍍鉻花灑套裝。 第1座37樓及39樓(複式上層)A單位主人房內之浴室 第2座39樓(複式上層)A單位主人房內之浴室</p> <p>以下單位裝設1676毫米(長)x914毫米(寬)x584毫米(高)搪瓷鑄鐵浴缸配鍍鉻浴缸水龍頭及鍍鉻花灑套裝。 第2座37樓A單位主人房內之浴室 第3座37樓及38樓A單位主人房內之浴室</p> <p>以下單位裝設1524毫米(長)x813毫米(寬)x464毫米(高)搪瓷鑄鐵浴缸配鍍鉻浴缸水龍頭及鍍鉻花灑套裝。 第3座38樓(複式上層)C單位主人房內之浴室 第5座39樓(複式上層)C單位主人房內之浴室 第6座39樓(複式上層)C單位主人房內之浴室 第7座39樓(複式上層)C單位主人房內之浴室 第5座38樓及39樓A單位主人房內之浴室 第6座38樓及39樓A單位主人房內之浴室 第7座38樓及39樓A單位主人房內之浴室 第8座37樓及38樓A單位主人房內之浴室 第9座36樓及37樓A單位主人房內之浴室 第10座36樓及37樓A單位主人房內之浴室</p> <p>有關供水系統的類型及用料，請參閱「3.(j)供水」。</p> <p>有關設備之品牌名稱及產品型號，請參閱「設備說明表」。</p>
(c)	廚房	<p>不鏽鋼洗滌盆、鍍鉻冷熱水龍頭。木製廚櫃配亞克力飾面門板及鋁質手柄。實體面材檯面。嵌入式煤氣煮食爐、抽油煙機、微波爐、電焗爐、嵌入式雪櫃、洗衣及乾衣機、酒櫃、抽氣扇及燈飾。</p> <p>有關供水系統的類型及用料，請參閱「3.(j)供水」。</p> <p>有關設備之品牌名稱及產品型號，請參閱「設備說明表」。</p>
(d)	睡房	沒有裝置。
(e)	電話	<p>客廳、主人房及睡房裝有電話插座。</p> <p>有關接駁點的位置及數目，請參閱「機電裝置數量說明表」。</p>
(f)	天線	<p>客廳、主人房、套房、睡房及非廚房內士多房裝有可接收本地電視/電台節目的電視/電台天線插座。</p> <p>有關接駁點的位置及數目，請參閱「機電裝置數量說明表」。</p>

# FITTINGS, FINISHES AND APPLIANCES

## 裝置、裝修物料及設備

### 3. 室內裝置

	細項	描述
(g)	電力裝置	電力配電箱並裝設微型斷路器，裝設隱藏及外露的照明及供電之導管。 導管是部分隱藏及部分外露。 <sup>1</sup> 有關電插座及空調機接駁點的位置及數目，請參閱「機電裝置數量說明表」。
(h)	氣體供應	廚房裝有煤氣喉接駁煤氣煮食爐。
(i)	洗衣機接駁點	洗衣機接駁點設於廚房/士多房。備有設計為直徑22毫米之洗衣機來水位及設計為直徑40毫米之洗衣機去水位。
(j)	供水	冷熱水喉採用銅喉管。沖廁供水系統採用膠喉管。 喉管是部分隱藏及部分外露。 <sup>2</sup> 有熱水供應。

備註：

- 除部分隱藏於混凝土內之導管外，其他部分的導管均為外露。外露的導管可能被假天花、假陣、儲存櫃、覆面、非混凝土間牆、指定之槽位或其他物料遮蓋。
- 除部分隱藏於混凝土內之水管外，其他部分的水管均為外露。外露的水管可能被假天花、假陣、儲存櫃、覆面、非混凝土間牆、指定之槽位或其他物料遮蓋。

### 4. 雜項

	細項	描述
(a)	升降機	住宅大樓： 各座住宅大樓裝有2部“東芝”住客升降機穿梭以下樓層：  第1座1號升降機(產品型號：ELBRIGHT(CL-300W))： 1樓、5樓、7樓至12樓、15樓至18樓、隔火層/空中花園、20樓至23樓、25樓至33樓及35樓至37樓  第1座2號升降機(產品型號：ELBRIGHT(CL-300W))： 1樓、5樓、7樓至12樓、15樓至18樓、隔火層/空中花園、22樓至23樓、25樓至33樓及35樓至38樓  第2座4號升降機(產品型號：ELBRIGHT(CL-300W))： 1樓、5樓、7樓至12樓、15樓至18樓、隔火層/空中花園、20樓至23樓、25樓至33樓及35樓至37樓  第2座5號升降機(產品型號：ELBRIGHT(CL-300W))： 1樓、5樓、7樓至12樓、15樓至18樓、隔火層/空中花園、22樓至23樓、25樓至33樓及35樓至38樓  第3座8號及9號升降機(產品型號：ELBRIGHT(CL-300W))： 1樓、3樓、5樓至6樓、平台、7樓至12樓、15樓至23樓、25樓至33樓及35樓至38樓  第5座11號及12號升降機(產品型號：ELBRIGHT(CL-300W))： 地下、1樓、3樓、5樓至6樓、平台、7樓至12樓、15樓至23樓、25樓至33樓及35樓至39樓  第6座14號及15號升降機(產品型號：ELBRIGHT(CL-300W))： 地下、1樓、3樓、5樓至6樓、平台、7樓至12樓、15樓至19樓、隔火層/空中花園、22樓至23樓、25樓至33樓及35樓至39樓  第7座17號及18號升降機(產品型號：ELBRIGHT(CL-300W))： 地下、1樓、3樓、5樓至6樓、平台、7樓至12樓、15樓至19樓、隔火層/空中花園、22樓至23樓、25樓至33樓及35樓至39樓  第8座20號及21號升降機(產品型號：ELBRIGHT(CL-300W))： 地下、1樓、3樓、5樓至6樓、平台、7樓至12樓、15樓至23樓、25樓至33樓及35樓至38樓  第9座23號及24號升降機(產品型號：ELBRIGHT(CL-300W))： 地下、1樓、3樓、5樓至6樓、平台、7樓至12樓、15樓至19樓、隔火層/空中花園、22樓至23樓、25樓至33樓及35樓至37樓  第10座26號及27號升降機(產品型號：ELBRIGHT(CL-300W))： 地下、1樓、5樓至6樓、平台、7樓至12樓、15樓至19樓、隔火層/空中花園、22樓至23樓、25樓至33樓及35樓至37樓



# FITTINGS, FINISHES AND APPLIANCES

## 裝置、裝修物料及設備

### 4. 雜項

	細項	描述
(a)	升降機	<p>各座住宅大樓裝有1部“東芝”消防升降機穿梭以下樓層：</p> <p>第1座3號消防升降機(產品型號：ELBRIGHT(CL-300W))： 向A單位之升降機門穿梭以下樓層：1樓、5樓、7樓至12樓、15樓至18樓、隔火層/空中花園、20樓至23樓、25樓至33樓及35樓至36樓</p> <p>向B單位之升降機門穿梭以下樓層：1樓、3樓、5樓、7樓至12樓、15樓至18樓、隔火層/空中花園、22樓至23樓、25樓至33樓及35樓至38樓</p> <p>第2座6號消防升降機(產品型號：ELBRIGHT(CL-300W))： 向A單位之升降機門穿梭以下樓層：1樓、5樓、7樓至12樓、15樓至18樓、隔火層/空中花園、20樓至23樓、25樓至33樓及35樓至36樓</p> <p>向B單位之升降機門穿梭以下樓層：1樓至3樓、5樓、7樓至12樓、15樓至18樓、隔火層/空中花園、22樓至23樓、25樓至33樓及35樓至38樓</p> <p>第3座7號消防升降機(產品型號：ELBRIGHT(CL-300W))： 1樓、3樓、5樓至6樓、平台、7樓至12樓、15樓至23樓、25樓至33樓及35樓至38樓</p> <p>第5座10號消防升降機(產品型號：ELBRIGHT(CL-300W))： 地下、1樓、3樓、5樓至6樓、平台、7樓至12樓、15樓至23樓、25樓至33樓及35樓至39樓</p> <p>第6座13號消防升降機(產品型號：ELBRIGHT(CL-300W))： 地下、1樓、3樓、5樓至6樓、平台、7樓至12樓、15樓至19樓、隔火層/空中花園、22樓至23樓、25樓至33樓及35樓至39樓</p> <p>第7座16號消防升降機(產品型號：ELBRIGHT(CL-300W))： 地下、1樓、3樓、5樓至6樓、平台、7樓至12樓、15樓至19樓、隔火層/空中花園、22樓至23樓、25樓至33樓及35樓至39樓</p> <p>第8座19號消防升降機(產品型號：ELBRIGHT(CL-300W))： 地下、1樓、3樓、5樓至6樓、平台、7樓至12樓、15樓至23樓、25樓至33樓及35樓至38樓</p> <p>第9座22號消防升降機(產品型號：ELBRIGHT(CL-300W))： 地下、1樓、3樓、5樓至6樓、平台、7樓至12樓、15樓至19樓、隔火層/空中花園、22樓至23樓、25樓至33樓及35樓至37樓</p> <p>第10座25號消防升降機(產品型號：ELBRIGHT(CL-300W))： 地下、1樓、5樓至6樓、平台、7樓至12樓、15樓至19樓、隔火層/空中花園、22樓至23樓、25樓至33樓及35樓至37樓</p>

	細項	描述
(a)	升降機	<p>平台： 5部“東芝”住客升降機(產品型號：SPACEL-UNI(CV300))穿梭地下至1樓</p> <p>會所： 4部“東芝”住客升降機(產品型號：SPACEL-UNI(CV300))穿梭會所樓層</p>
(b)	信箱	不鏽鋼信箱。
(c)	垃圾收集	<p>第1座及第2座：每層設垃圾槽，垃圾會由清潔工人於地下收集運送至地下之垃圾及物料回收房中央垃圾收集處理，由垃圾車運走。</p> <p>第3座、第5座至第10座：垃圾由清潔工人於每層住宅樓層之公共垃圾箱收集及運送至地下之垃圾及物料回收房中央垃圾收集處理，由垃圾車運走。</p>
(d)	水錶、電錶及氣體錶	<p>每戶之獨立水錶設於大廈住宅樓層之水錶槽。</p> <p>每戶之獨立電錶設於大廈住宅樓層之電錶房。</p> <p>第1座及第2座： 每戶的冷氣機房預留安裝獨立煤氣錶之位置。</p> <p>第3座、第5座至第10座： 每戶的廚房預留安裝獨立煤氣錶之位置。</p> <p>除以下單位： 第6座38樓C單位：每戶的儲物房預留安裝獨立煤氣錶之位置。</p>

# FITTINGS, FINISHES AND APPLIANCES

## 裝置、裝修物料及設備

### 5. 保安設施

細項	描述
保安系統及設備	<p>發展項目入口、地下主入口大堂、3樓大廈升降機大堂、升降機內、停車場入口、停車場及會所設有閉路電視，並連接管理處。</p> <p>訪客對講機及智能卡出入保安系統設於地下主入口大堂及3樓入口大堂，並連接每戶之視像對講機。每戶設有視像對講機。</p>

賣方承諾如該項目中沒有安裝指明的品牌名稱或產品型號的升降機或設備，便會安裝品質相若的升降機或設備。

# FITTINGS, FINISHES AND APPLIANCES

## 裝置、裝修物料及設備

### 6. Appliances 設備

#### Appliances Schedule 設備說明表

#### Tower 1 第1座

Location 位置	Appliances 設備	Brand Name 品牌名稱	7/F 7樓		8/F to 18/F & 22/F to 36/F 8樓至18樓及22樓至36樓		20/F to 21/F 20樓至21樓	37/F 37樓	38/F & 39/F 38樓及39樓
			A	B	A	B	A	A	A
			Model Number 產品型號						
Living Room, Dining Room & Corridor 客廳、飯廳 及走廊	Split Type Air-Conditioner 分體式冷氣機	Panasonic/ Hitachi* 日立 (only apply to the model number with*) (只適用於 註有“*” 的型號)	Indoor Unit 室內機		Indoor Unit 室內機		Indoor Unit 室內機	Indoor Unit 室內機	Indoor Unit 室內機
			CS-E23JD4H(2NOS.)/ CS-E15HD3EA/ CS-E10HD3EA	CS-E23JD4H(2NOS.)/ RPI-1.5FSN2*/ CS-E10HD3EA	CS-E23JD4H(2NOS.)/ CS-E15HD3EA/ CS-E10HD3EA	CS-E23JD4H(2NOS.)/ CS-E15HD3EA/ CS-E10HD3EA	CS-E23JD4H(2NOS.)/ CS-E15HD3EA/ CS-E10HD3EA	CS-E23JD4H(3NOS.)/ CS-E9JD4H	CS-E23JD4H(3NOS.)/ CS-E9JD4H
			Outdoor Unit 室外機		Outdoor Unit 室外機		Outdoor Unit 室外機	Outdoor Unit 室外機	Outdoor Unit 室外機
			CU-E23JBH(2NOS.)/ CU-4E23JBE (Shared Outdoor Unit) (共用室外組件)/ CU-4E23JBE (Shared Outdoor Unit) (共用室外組件)	CU-E23JBH(2NOS.)/ RAS-BFSNI* (Shared Outdoor Unit) (共用室外組件)/ CU-4E23JBE (Shared Outdoor Unit) (共用室外組件)	CU-E23JBH(2NOS.)/ CU-4E23JBE (Shared Outdoor Unit) (共用室外組件)/ CU-4E23JBE (Shared Outdoor Unit) (共用室外組件)	CU-E23JBH(2NOS.)/ CU-4E23JBE (Shared Outdoor Unit) (共用室外組件)/ CU-4E23JBE (Shared Outdoor Unit) (共用室外組件)	CU-E23JBH(2NOS.)/ CU-4E23JBE (Shared Outdoor Unit) (共用室外組件)/ CU-4E23JBE (Shared Outdoor Unit) (共用室外組件)	CU-E23JBH(3NOS.)/ CU-E9JBH	CU-E23JBH(3NOS.)/ CU-E9JBH

The vendor undertakes that if lifts and appliances of the specified brand name or model number are not installed in the Development, lifts or appliances of comparable quality will be installed.  
賣方承諾如該發展項目中沒有安裝指明的品牌名稱或產品型號的升降機或設備，便會安裝品質相若的升降機或設備。

#### Notes:

- The residential floors start from 7/F in all towers of the Development.
- There is no Tower 4 in the Development.
- There are no 4/F, 13/F, 14/F, 24/F and 34/F in all towers of the Development.
- There are no 6/F and 19/F in Tower 1 and Tower 2 and no 20/F and 21/F in Tower 6, Tower 7, Tower 9 and Tower 10.
- There are no 2/F in Tower 3, Tower 5, Tower 6, Tower 7, Tower 8, Tower 9 and Tower 10.
- The symbol “-” as shown in the above table denotes “Not Provided”.
- The cells shaded in grey “■” as shown in the above table denotes “Not Applicable”.

#### 備註：

- 發展項目內所有座樓之住宅由7樓開始。
- 發展項目不設第4座。
- 發展項目內所有座樓均不設4樓、13樓、14樓、24樓及34樓。
- 第1座及第2座均不設6樓及19樓；第6座、第7座、第9座及第10座均不設20樓及21樓。
- 第3座、第5座、第6座、第7座、第8座、第9座及第10座均不設2樓。
- 上表內之“-”符號代表“沒有提供”。
- 上表內填上灰色“■”之部分代表“不適用”。

# FITTINGS, FINISHES AND APPLIANCES

## 裝置、裝修物料及設備

### Appliances Schedule 設備說明表

#### Tower 1 第1座

Location 位置	Appliances 設備	Brand Name 品牌名稱	7/F 7樓		8/F to 18/F & 22/F to 36/F 8樓至18樓及22樓至36樓		20/F to 21/F 20樓至21樓	37/F 37樓	38/F & 39/F 38樓及39樓
			A	B	A	B	A	A	A
			Model Number 產品型號						
Master Bedroom 主人房	Split Type Air-Conditioner 分體式冷氣機	Panasonic/ Hitachi* 日立 (only apply to the model number with*) (只適用於 註有“*” 的型號)	Indoor Unit 室內機		Indoor Unit 室內機		Indoor Unit 室內機	Indoor Unit 室內機	Indoor Unit 室內機
			CS-E18JD4H(2NOS.)/ CS-E15HD3EA	RPI-2.0FSN2(2NOS.)*/ CS-E15HD3EA	CS-E18JD4H(2NOS.)/ CS-E15HD3EA	CS-E18JD4H(2NOS.)/ CS-E15HD3EA	CS-E18JD4H(2NOS.)/ CS-E15HD3EA	CS-E18JD4H (2NOS.)	CS-E18JD4H (2NOS.)
			Outdoor Unit 室外機		Outdoor Unit 室外機		Outdoor Unit 室外機	Outdoor Unit 室外機	Outdoor Unit 室外機
			CU-E18JBH(2NOS.)/ CU-4E23JBE (Shared Outdoor Unit) (共用室外組件)	RAS-BFSN1* (Shared Outdoor Unit) (共用室外組件)/ CU-4E23JBE (Shared Outdoor Unit) (共用室外組件)	CU-E18JBH(2NOS.)/ CU-4E23JBE (Shared Outdoor Unit) (共用室外組件)	CU-E18JBH(2NOS.)/ CU-4E23JBE (Shared Outdoor Unit) (共用室外組件)	CU-E18JBH(2NOS.)/ CU-4E23JBE (Shared Outdoor Unit) (共用室外組件)	CU-E18JBH(2NOS.)	CU-E18JBH(2NOS.)
Ensuite Bedroom / Ensuite Bedroom 1 套房 / 套房 1	Split Type Air-Conditioner 分體式冷氣機	Panasonic/ Hitachi* 日立 (only apply to the model number with*) (只適用於 註有“*” 的型號)	Indoor Unit 室內機		Indoor Unit 室內機		Indoor Unit 室內機	Indoor Unit 室內機	Indoor Unit 室內機
			CS-E15HD3EA	RPI-1.5FSN2*	CS-E15HD3EA	CS-E15HD3EA	CS-E15HD3EA	CU-E18JD4H(2NOS.)	CU-E18JD4H(2NOS.)
			Outdoor Unit 室外機		Outdoor Unit 室外機		Outdoor Unit 室外機	Outdoor Unit 室外機	Outdoor Unit 室外機
			CU-4E23JBE (Shared Outdoor Unit) (共用室外組件)	RAS-BFSN1* (Shared Outdoor Unit) (共用室外組件)	CU-4E23JBE (Shared Outdoor Unit) (共用室外組件)	CU-4E23JBE (Shared Outdoor Unit) (共用室外組件)	CU-4E23JBE (Shared Outdoor Unit) (共用室外組件)	CU-E18JBH(2NOS.)	CU-E18JBH(2NOS.)

The vendor undertakes that if lifts and appliances of the specified brand name or model number are not installed in the Development, lifts or appliances of comparable quality will be installed.  
賣方承諾如該發展項目中沒有安裝指明的品牌名稱或產品型號的升降機或設備，便會安裝品質相若的升降機或設備。

#### Notes:

- The residential floors start from 7/F in all towers of the Development.
- There is no Tower 4 in the Development.
- There are no 4/F, 13/F, 14/F, 24/F and 34/F in all towers of the Development.
- There are no 6/F and 19/F in Tower 1 and Tower 2 and no 20/F and 21/F in Tower 6, Tower 7, Tower 9 and Tower 10.
- There are no 2/F in Tower 3, Tower 5, Tower 6, Tower 7, Tower 8, Tower 9 and Tower 10.
- The symbol “-” as shown in the above table denotes “Not Provided”.
- The cells shaded in grey “■” as shown in the above table denotes “Not Applicable”.

#### 備註：

- 發展項目內所有座樓之住宅由7樓開始。
- 發展項目不設第4座。
- 發展項目內所有座樓均不設4樓、13樓、14樓、24樓及34樓。
- 第1座及第2座均不設6樓及19樓；第6座、第7座、第9座及第10座均不設20樓及21樓。
- 第3座、第5座、第6座、第7座、第8座、第9座及第10座均不設2樓。
- 上表內之“-”符號代表“沒有提供”。
- 上表內填上灰色“■”之部分代表“不適用”。

# FITTINGS, FINISHES AND APPLIANCES

## 裝置、裝修物料及設備

### Appliances Schedule 設備說明表

#### Tower 1 第1座

Location 位置	Appliances 設備	Brand Name 品牌名稱	7/F 7樓		8/F to 18/F & 22/F to 36/F 8樓至18樓及22樓至36樓		20/F to 21/F 20樓至21樓	37/F 37樓	38/F & 39/F 38樓及39樓
			A	B	A	B	A	A	A
			Model Number 產品型號						
Ensuite Bedroom 2 套房 2	Split Type Air-Conditioner 分體式冷氣機	Panasonic	Indoor Unit 室內機		Indoor Unit 室內機		Indoor Unit 室內機	Indoor Unit 室內機	Indoor Unit 室內機
							CS-E18JD4H	CS-E18JD4H	
			Outdoor Unit 室外機		Outdoor Unit 室外機		Outdoor Unit 室外機	Outdoor Unit 室外機	Outdoor Unit 室外機
							CU-E18JBH	CU-E18JBH	
Kitchen 廚房	Split Type Air-Conditioner 分體式冷氣機	Panasonic	Indoor Unit 室內機		Indoor Unit 室內機		Indoor Unit 室內機	Indoor Unit 室內機	Indoor Unit 室內機
			CS-E9JKEW/ CS-E15HD3EA	CS-E9JKEW/ CS-E15HD3EA	CS-E9JKEW/ CS-E15HD3EA	CS-E9JKEW/ CS-E15HD3EA	CS-E9JKEW/ CS-E15HD3EA	CS-E9JKEW/ CS-E15HD3EA	CS-E9JKEW/ CS-E15HD3EA
			Outdoor Unit 室外機		Outdoor Unit 室外機		Outdoor Unit 室外機	Outdoor Unit 室外機	Outdoor Unit 室外機
			CU-4E23JBE (Shared Outdoor Unit) 共用室外組件/ CU-4E23JBE (Shared Outdoor Unit) 共用室外組件	CU-4E23JBE (Shared Outdoor Unit) 共用室外組件/ CU-4E23JBE (Shared Outdoor Unit) 共用室外組件	CU-4E23JBE (Shared Outdoor Unit) 共用室外組件/ CU-4E23JBE (Shared Outdoor Unit) 共用室外組件	CU-4E23JBE (Shared Outdoor Unit) 共用室外組件/ CU-4E23JBE (Shared Outdoor Unit) 共用室外組件	CU-4E23JBE (Shared Outdoor Unit) 共用室外組件/ CU-4E23JBE (Shared Outdoor Unit) 共用室外組件	CU-4E23JBE	CU-4E23JBE

The vendor undertakes that if lifts and appliances of the specified brand name or model number are not installed in the Development, lifts or appliances of comparable quality will be installed.  
賣方承諾如該發展項目中沒有安裝指明的品牌名稱或產品型號的升降機或設備，便會安裝品質相若的升降機或設備。

#### Notes:

- The residential floors start from 7/F in all towers of the Development.
- There is no Tower 4 in the Development.
- There are no 4/F, 13/F, 14/F, 24/F and 34/F in all towers of the Development.
- There are no 6/F and 19/F in Tower 1 and Tower 2 and no 20/F and 21/F in Tower 6, Tower 7, Tower 9 and Tower 10.
- There are no 2/F in Tower 3, Tower 5, Tower 6, Tower 7, Tower 8, Tower 9 and Tower 10.
- The symbol “-” as shown in the above table denotes “Not Provided”.
- The cells shaded in grey “■” as shown in the above table denotes “Not Applicable”.

#### 備註：

- 發展項目內所有座樓之住宅由7樓開始。
- 發展項目不設第4座。
- 發展項目內所有座樓均不設4樓、13樓、14樓、24樓及34樓。
- 第1座及第2座均不設6樓及19樓；第6座、第7座、第9座及第10座均不設20樓及21樓。
- 第3座、第5座、第6座、第7座、第8座、第9座及第10座均不設2樓。
- 上表內之“-”符號代表“沒有提供”。
- 上表內填上灰色“■”之部分代表“不適用”。

# FITTINGS, FINISHES AND APPLIANCES

## 裝置、裝修物料及設備

### Appliances Schedule 設備說明表

#### Tower 1 第1座

Location 位置	Appliances 設備	Brand Name 品牌名稱	7/F 7樓		8/F to 18/F & 22/F to 36/F 8樓至18樓及22樓至36樓		20/F to 21/F 20樓至21樓	37/F 37樓	38/F & 39/F 38樓及39樓	
			A	B	A	B	A	A	A	
			Model Number 產品型號							
Family Room 家庭室	Split Type Air-Conditioner 分體式冷氣機	Panasonic	Indoor Unit 室內機		Indoor Unit 室內機		Indoor Unit 室內機	Indoor Unit 室內機	Indoor Unit 室內機	
									CS-E23JD4H	
			Outdoor Unit 室外機		Outdoor Unit 室外機		Outdoor Unit 室外機	Outdoor Unit 室外機	Outdoor Unit 室外機	Outdoor Unit 室外機
									CU-E23JBH	

The vendor undertakes that if lifts and appliances of the specified brand name or model number are not installed in the Development, lifts or appliances of comparable quality will be installed.  
賣方承諾如該發展項目中沒有安裝指明的品牌名稱或產品型號的升降機或設備，便會安裝品質相若的升降機或設備。

#### Notes:

- The residential floors start from 7/F in all towers of the Development.
- There is no Tower 4 in the Development.
- There are no 4/F, 13/F, 14/F, 24/F and 34/F in all towers of the Development.
- There are no 6/F and 19/F in Tower 1 and Tower 2 and no 20/F and 21/F in Tower 6, Tower 7, Tower 9 and Tower 10.
- There are no 2/F in Tower 3, Tower 5, Tower 6, Tower 7, Tower 8, Tower 9 and Tower 10.
- The symbol “-” as shown in the above table denotes “Not Provided”.
- The cells shaded in grey “■” as shown in the above table denotes “Not Applicable”.

#### 備註：

- 發展項目內所有座樓之住宅由7樓開始。
- 發展項目不設第4座。
- 發展項目內所有座樓均不設4樓、13樓、14樓、24樓及34樓。
- 第1座及第2座均不設6樓及19樓；第6座、第7座、第9座及第10座均不設20樓及21樓。
- 第3座、第5座、第6座、第7座、第8座、第9座及第10座均不設2樓。
- 上表內之“-”符號代表“沒有提供”。
- 上表內填上灰色“■”之部分代表“不適用”。

# FITTINGS, FINISHES AND APPLIANCES

## 裝置、裝修物料及設備

### Appliances Schedule 設備說明表

#### Tower 1 第1座

Location 位置	Appliances 設備	Brand Name 品牌名稱	7/F 7樓		8/F to 18/F & 22/F to 36/F 8樓至18樓及22樓至36樓		20/F to 21/F 20樓至21樓	37/F 37樓	38/F & 39/F 38樓及39樓
			A	B	A	B	A	A	A
			Model Number 產品型號						
Living Room, Dining Room & Corridor 客廳、飯廳及 走廊	Door Bell 門鐘	Hager 海格	XC001	XC001	XC001	XC001	-	XC001	XC001
Kitchen 廚房	Cooker Hood 抽油煙機	Miele 美諾	DA422-4	DA422-4	DA422-4	DA422-4	DA422-4	DA422-4	DA422-4
	Gas Cooking Hob 煤氣煮食爐	Miele 美諾	CS1028 CS1013G	CS1028 CS1013G	CS1028 CS1013G	CS1028 CS1013G	CS1028 CS1013G	CS1028 CS1013G	CS1028 CS1013G
	Gas Water Heater 煤氣熱水爐	TGC	NJW160TFQL <sup>(1)</sup>	NJW160TFQL <sup>(1)</sup>	NJW160TFQL <sup>(1)</sup>	NJW160TFQL <sup>(1)</sup>	NJW160TFQL <sup>(1)</sup>	NJW220TFQL <sup>(3)</sup>	NJW220TFQL <sup>(4)</sup>
	Microwave Oven 微波爐	Miele 美諾	-	-	-	-	-	M8161-2	M8161-2
	Refrigerator 雪櫃	Siemens 西門子	-	-	-	-	-	K138VA	K138VA
Sub-Zero		ICBBI-48S	ICBBI-48S	ICBBI-48S	ICBBI-48S	ICBBI-48S	ICBBI-48S	ICBBI-48S	

The vendor undertakes that if lifts and appliances of the specified brand name or model number are not installed in the Development, lifts or appliances of comparable quality will be installed.  
賣方承諾如該發展項目中沒有安裝指明的品牌名稱或產品型號的升降機或設備，便會安裝品質相若的升降機或設備。

#### Notes:

- The residential floors start from 7/F in all towers of the Development.
  - There is no Tower 4 in the Development.
  - There are no 4/F, 13/F, 14/F, 24/F and 34/F in all towers of the Development.
  - There are no 6/F and 19/F in Tower 1 and Tower 2 and no 20/F and 21/F in Tower 6, Tower 7, Tower 9 and Tower 10.
  - There are no 2/F in Tower 3, Tower 5, Tower 6, Tower 7, Tower 8, Tower 9 and Tower 10.
  - The symbol “-” as shown in the above table denotes “Not Provided”.
  - The cells shaded in grey “■” as shown in the above table denotes “Not Applicable”.
- (1) : The gas water heater located at A/C room & served for Bathroom in Ensuite Bedroom / Ensuite Bedroom 1 and Kitchen  
(2) : The gas water heater located at A/C room & served for Bathroom and Lavatory leading from Kitchen  
(3) : The gas water heater located at A/C room & served for Lavatory leading from Kitchen, Kitchen and Bathroom  
(4) : The gas water heater located at A/C room & served for Lavatory near to Living Room and Bathroom in Ensuite Bedroom 2.

#### 備註：

- 發展項目內所有座樓之住宅由7樓開始。
  - 發展項目不設第4座。
  - 發展項目內所有座樓均不設4樓、13樓、14樓、24樓及34樓。
  - 第1座及第2座均不設6樓及19樓；第6座、第7座、第9座及第10座均不設20樓及21樓。
  - 第3座、第5座、第6座、第7座、第8座、第9座及第10座均不設2樓。
  - 上表內之“-”符號代表“沒有提供”。
  - 上表內填上灰色“■”之部分代表“不適用”。
- (1) : 該款煤氣熱水爐位於冷氣機房及供應熱水給套房/套房1內之浴室和廚房  
(2) : 該款煤氣熱水爐位於冷氣機房及供應熱水給浴室和由廚房通往之洗手間  
(3) : 該款煤氣熱水爐位於冷氣機房及供應熱水給由廚房通往之洗手間、廚房和浴室  
(4) : 該款煤氣熱水爐位於冷氣機房及供應熱水給鄰近客廳之洗手間和套房2內之浴室

# FITTINGS, FINISHES AND APPLIANCES

## 裝置、裝修物料及設備

### Appliances Schedule 設備說明表

#### Tower 1 第1座

Location 位置	Appliances 設備	Brand Name 品牌名稱	7/F 7樓		8/F to 18/F & 22/F to 36/F 8樓至18樓及22樓至36樓		20/F to 21/F 20樓至21樓	37/F 37樓	38/F & 39/F 38樓及39樓
			A	B	A	B	A	A	A
			Model Number 產品型號						
Kitchen 廚房	Washer/Dryer 洗衣/乾衣機	Miele 美諾	W1712/ T7744C	W1712/ T7744C	W1712/ T7744C	W1712/ T7744C	W1712/ T7744C	W3844/ T4804C	W3844/ T4804C
	Exhaust Fan 抽氣扇	Xpelair	GX 6	GX 6	GX 6	GX 6	GX 6	GX 9	GX 9
	Electric Oven 電焗爐	Miele 美諾	H5981HP	H5981HP	H5981HP	H5981HP	H5981HP	H5981HP	H5981HP
	Induction Hob 電磁爐	Miele 美諾	CS122II	CS122II	CS122II	CS122II	CS122II	CS122II	CS122II
	Steam Oven 電蒸爐	Miele 美諾	-	-	-	-	-	DGC5051	DGC5051
	Wine Cellar 酒櫃	Miele 美諾	KWT4154UG-1	KWT4154UG-1	KWT4154UG-1	KWT4154UG-1	KWT4154UG-1	KWT1601	KWT1601
	Dishwasher 洗碗碟機	Miele 美諾	-	-	-	-	-	G5570SCVi	G5570SCVi
	Door Bell 門鐘	Hager 海格	XC001	XC001	XC001	XC001	XC001	XC001	XC001
	Videophone 視像對講機	Bitron	AV2850/1	AV2850/1	AV2850/1	AV2850/1	AV2850/1	AV2850/1	AV2850/1

The vendor undertakes that if lifts and appliances of the specified brand name or model number are not installed in the Development, lifts or appliances of comparable quality will be installed.  
賣方承諾如該發展項目中沒有安裝指明的品牌名稱或產品型號的升降機或設備，便會安裝品質相若的升降機或設備。

#### Notes:

- The residential floors start from 7/F in all towers of the Development.
- There is no Tower 4 in the Development.
- There are no 4/F, 13/F, 14/F, 24/F and 34/F in all towers of the Development.
- There are no 6/F and 19/F in Tower 1 and Tower 2 and no 20/F and 21/F in Tower 6, Tower 7, Tower 9 and Tower 10.
- There are no 2/F in Tower 3, Tower 5, Tower 6, Tower 7, Tower 8, Tower 9 and Tower 10.
- The symbol “-” as shown in the above table denotes “Not Provided”.
- The cells shaded in grey “■” as shown in the above table denotes “Not Applicable”.

#### 備註：

- 發展項目內所有座樓之住宅由7樓開始。
- 發展項目不設第4座。
- 發展項目內所有座樓均不設4樓、13樓、14樓、24樓及34樓。
- 第1座及第2座均不設6樓及19樓；第6座、第7座、第9座及第10座均不設20樓及21樓。
- 第3座、第5座、第6座、第7座、第8座、第9座及第10座均不設2樓。
- 上表內之“-”符號代表“沒有提供”。
- 上表內填上灰色“■”之部分代表“不適用”。



# FITTINGS, FINISHES AND APPLIANCES

## 裝置、裝修物料及設備

### Appliances Schedule 設備說明表

#### Tower 1 第1座

Location 位置	Appliances 設備	Brand Name 品牌名稱	7/F 7樓		8/F to 18/F & 22/F to 36/F 8樓至18樓及22樓至36樓		20/F to 21/F 20樓至21樓	37/F 37樓	38/F & 39/F 38樓及39樓
			A	B	A	B	A	A	A
			Model Number 產品型號						
Bathroom in Master Bedroom 主人房內之浴室	15"LCD TV 15"液晶電視	JSA	TMBG15	TMBG15	TMBG15	TMBG15	TMBG15	TMBG15	TMBG15
	10"LCD TV 10"液晶電視	JSA	-	-	-	-	-	TMBG10i	TMBG10i
	Ceiling Speaker 揚聲器	OBT	701	701	701	701	701	-	-
		KEF	-	-	-	-	-	2 x Cs130.2FS	2 x Cs130.2FS
	Gas Water Heater 煤氣熱水爐	TGC	NJW220TFQL	NJW220TFQL	NJW220TFQL	NJW220TFQL	NJW220TFQL	NJW220TFQL	NJW220TFQL
	Exhaust Fan 抽氣扇	Ostberg 奧斯博格	REF 200B	REF 200B	REF 200B	REF 200B	REF 200B	REF-2000B	REF-2000B
Bathroom in Ensuite Bedroom / Ensuite Bedroom 1 套房 / 套房1內 之浴室	Gas Water Heater 煤氣熱水爐	TGC	NJW160TFQL <sup>(1)</sup>	NJW160TFQL <sup>(1)</sup>	NJW160TFQL <sup>(1)</sup>	NJW160TFQL <sup>(1)</sup>	NJW160TFQL <sup>(1)</sup>	NJW220TFQL	NJW220TFQL
	Exhaust Fan 抽氣扇	Ostberg 奧斯博格	REF 140A	REF 140A	REF 140A	REF 140A	REF 140A	REF 140B	REF 140B
Bathroom in Ensuite Bedroom 2 套房2內之浴室	Gas Water Heater 煤氣熱水爐	TGC						NJW220TFQL <sup>(4)</sup>	NJW220TFQL <sup>(4)</sup>
	Exhaust Fan 抽氣扇	Ostberg 奧斯博格						RFE 140A	RFE 140A

The vendor undertakes that if lifts and appliances of the specified brand name or model number are not installed in the Development, lifts or appliances of comparable quality will be installed.  
賣方承諾如該發展項目中沒有安裝指明的品牌名稱或產品型號的升降機或設備，便會安裝品質相若的升降機或設備。

#### Notes:

- The residential floors start from 7/F in all towers of the Development.
- There is no Tower 4 in the Development.
- There are no 4/F, 13/F, 14/F, 24/F and 34/F in all towers of the Development.
- There are no 6/F and 19/F in Tower 1 and Tower 2 and no 20/F and 21/F in Tower 6, Tower 7, Tower 9 and Tower 10.
- There are no 2/F in Tower 3, Tower 5, Tower 6, Tower 7, Tower 8, Tower 9 and Tower 10.
- The symbol “-” as shown in the above table denotes “Not Provided”.
- The cells shaded in grey “■” as shown in the above table denotes “Not Applicable”.

#### 備註：

- 發展項目內所有座樓之住宅由7樓開始。
- 發展項目不設4座。
- 發展項目內所有座樓均不設4樓、13樓、14樓、24樓及34樓。
- 第1座及第2座均不設6樓及19樓；第6座、第7座、第9座及第10座均不設20樓及21樓。
- 第3座、第5座、第6座、第7座、第8座、第9座及第10座均不設2樓。
- 上表內之“-”符號代表“沒有提供”。
- 上表內填上灰色“■”之部分代表“不適用”。

# FITTINGS, FINISHES AND APPLIANCES

## 裝置、裝修物料及設備

### Appliances Schedule 設備說明表

#### Tower 1 第1座

Location 位置	Appliances 設備	Brand Name 品牌名稱	7/F 7樓		8/F to 18/F & 22/F to 36/F 8樓至18樓及22樓至36樓		20/F to 21/F 20樓至21樓	37/F 37樓	38/F & 39/F 38樓及39樓
			A	B	A	B	A	A	A
			Model Number 產品型號						
Bathroom 浴室	Gas Water Heater 煤氣熱水爐	TGC	NJW160TFQL <sup>(2)</sup>	NJW160TFQL <sup>(2)</sup>	NJW160TFQL <sup>(2)</sup>	NJW160TFQL <sup>(2)</sup>	NJW160TFQL <sup>(2)</sup>	NJW220TFQL <sup>(3)</sup>	NJW220TFQL <sup>(3)</sup>
	Exhaust Fan 抽氣扇	Xpelair	GX 6	-	GX 6	-	GX 6	-	-
		Ostberg 奧斯博格	-	REF140A	-	REF140A	-	RFE 140B	RFE 140A
Lavatory near to Living Room 鄰近客廳之 洗手間	Gas Water Heater 煤氣熱水爐	TGC						NJW220TFQL <sup>(4)</sup>	NJW220TFQL <sup>(4)</sup>
	Exhaust Fan 抽氣扇	Xpelair						RFE 140A	RFE 140A
Lavatory leading from Kitchen 由廚房通往之 洗手間	Gas Water Heater 煤氣熱水爐	TGC	NJW160TFQL <sup>(2)</sup>	NJW160TFQL <sup>(2)</sup>	NJW160TFQL <sup>(2)</sup>	NJW160TFQL <sup>(2)</sup>	NJW160TFQL <sup>(2)</sup>	NJW220TFQL <sup>(3)</sup>	NJW220TFQL <sup>(3)</sup>
	Exhaust Fan 抽氣扇	Xpelair	GX 6	GX 6	GX 6	GX 6	GX 6	GX 6	GX 6

The vendor undertakes that if lifts and appliances of the specified brand name or model number are not installed in the Development, lifts or appliances of comparable quality will be installed.  
賣方承諾如該發展項目中沒有安裝指明的品牌名稱或產品型號的升降機或設備，便會安裝品質相若的升降機或設備。

#### Notes:

- The residential floors start from 7/F in all towers of the Development.
  - There is no Tower 4 in the Development.
  - There are no 4/F, 13/F, 14/F, 24/F and 34/F in all towers of the Development.
  - There are no 6/F and 19/F in Tower 1 and Tower 2 and no 20/F and 21/F in Tower 6, Tower 7, Tower 9 and Tower 10.
  - There are no 2/F in Tower 3, Tower 5, Tower 6, Tower 7, Tower 8, Tower 9 and Tower 10.
  - The symbol “-” as shown in the above table denotes “Not Provided”.
  - The cells shaded in grey “■” as shown in the above table denotes “Not Applicable”.
- (1): The gas water heater located at A/C room & served for Bathroom in Ensuite Bedroom / Ensuite Bedroom 1 and Kitchen  
(2): The gas water heater located at A/C room & served for Bathroom and Lavatory leading from Kitchen  
(3): The gas water heater located at A/C room & served for Lavatory leading from Kitchen, Kitchen and Bathroom  
(4): The gas water heater located at A/C room & served for Lavatory near to Living Room and Bathroom in Ensuite Bedroom 2.

#### 備註:

- 發展項目內所有座樓之住宅由7樓開始。
  - 發展項目不設第4座。
  - 發展項目內所有座樓均不設4樓、13樓、14樓、24樓及34樓。
  - 第1座及第2座均不設6樓及19樓；第6座、第7座、第9座及第10座均不設20樓及21樓。
  - 第3座、第5座、第6座、第7座、第8座、第9座及第10座均不設2樓。
  - 上表內之“-”符號代表“沒有提供”。
  - 上表內填上灰色“■”之部分代表“不適用”。
- (1): 該款煤氣熱水爐位於冷氣機房及供應熱水給套房/套房1內之浴室和廚房  
(2): 該款煤氣熱水爐位於冷氣機房及供應熱水給浴室和由廚房通往之洗手間  
(3): 該款煤氣熱水爐位於冷氣機房及供應熱水給由廚房通往之洗手間、廚房和浴室  
(4): 該款煤氣熱水爐位於冷氣機房及供應熱水給鄰近客廳之洗手間和套房2內之浴室

# FITTINGS, FINISHES AND APPLIANCES

## 裝置、裝修物料及設備

### Schedule of Mechanical and Electrical Provisions 機電裝置數量說明表

#### Tower 1 第1座

Location 位置	Exposed Type 外露型	Non-Exposed Type 非外露型	7/F 7樓		8/F to 18/F & 22/F to 36/F 8樓至18樓及22樓至36樓		20/F to 21/F 20樓至21樓	37/F 37樓	38/F 38樓	39/F 39樓
			A	B	A	B	A	A	A	A
Living Room, Dining Room & Corridor 客廳、飯廳及 走廊	TV/ FM Outlet 電視/電台天線插座		3	3	3	3	3	3	1	
	Telephone Outlet 電話插座		3	3	3	3	3	3	1	
	13A Twin Socket Outlet 13A雙位電插座		6	6	7	7	7	8	4	
	13A Single Socket Outlet 13A單位電插座		5	5	2	3	2	6	6	
	Lighting Switch 燈掣		7	7	7	7	7	9	9	
		Door Bell 門鐘		1	1	1	1	1	1	
		20A Double Pole Switch with Pilot Lamp 20A 雙極開關掣		1	1	1	1	1	2	2
	Fused Spur Unit/Connection Unit 接線座		1	1	1	1	1	1		
Master Bedroom 主人房	TV/ FM Outlet 電視/電台天線插座		2	2	2	2	2	2		2
	Telephone Outlet 電話插座		2	2	2	2	2	2		2
	13A Twin Socket Outlet 13A雙位電插座		3	3	3	3	3	4		4
	13A Single Socket Outlet 13A單位電插座		4	3	4	3	4	2		2
	Lighting Switch 燈掣		4	4	4	4	4	4		3
		20A Double Pole Switch with Pilot Lamp 20A 雙極開關掣		1	1	1	1	1	2	

#### Notes:

- The residential floors start from 7/F in all towers of the Development.
- There is no Tower 4 in the Development.
- There are no 4/F, 13/F, 14/F, 24/F and 34/F in all towers of the Development.
- There are no 6/F and 19/F in Tower 1 and Tower 2 and no 20/F and 21/F in Tower 6, Tower 7, Tower 9 and Tower 10.
- There are no 2/F in Tower 3, Tower 5, Tower 6, Tower 7, Tower 8, Tower 9 and Tower 10.
- The symbol “-” as shown in the above table denotes “Not Provided”.
- The cells shaded in grey “■” as shown in the above table denotes “Not Applicable”.

#### 備註:

- 發展項目內所有座樓之住宅由7樓開始。
- 發展項目不設第4座。
- 發展項目內所有座樓均不設4樓、13樓、14樓、24樓及34樓。
- 第1座及第2座均不設6樓及19樓；第6座、第7座、第9座及第10座均不設20樓及21樓。
- 第3座、第5座、第6座、第7座、第8座、第9座及第10座均不設2樓。
- 上表內之“-”符號代表“沒有提供”。
- 上表內填上灰色“■”之部分代表“不適用”。

# FITTINGS, FINISHES AND APPLIANCES

## 裝置、裝修物料及設備

### Schedule of Mechanical and Electrical Provisions 機電裝置數量說明表

#### Tower 1 第1座

Location 位置	Exposed Type 外露型	Non-Exposed Type 非外露型	7/F 7樓		8/F to 18/F & 22/F to 36/F 8樓至18樓及22樓至36樓		20/F to 21/F 20樓至21樓	37/F 37樓	38/F 38樓	39/F 39樓
			A	B	A	B	A	A	A	A
Ensuite Bedroom / Ensuite Bedroom 1 套房/套房1	TV/ FM Outlet 電視/電台天線插座		1	1	1	1	1	2	2	
	Telephone Outlet 電話插座		1	1	1	1	1	2	2	
	13A Twin Socket Outlet 13A雙位電插座		2	2	2	2	2	3	3	
	13A Single Socket Outlet 13A單位電插座		1	1	1	1	1	1	1	
	Lighting Switch 燈掣		2	2	2	2	2	4	4	
	20A Double Pole Switch with Pilot Lamp 20A 雙極開關掣		1	1	1	1	1	1	1	
Ensuite Bedroom 2 套房2	TV/ FM Outlet 電視/電台天線插座							2	2	
	Telephone Outlet 電話插座							1	1	
	13A Twin Socket Outlet 13A雙位電插座							4	4	
	13A Single Socket Outlet 13A單位電插座							1	1	
	Lighting Switch 燈掣							2	2	
	20A Double Pole Switch with Pilot Lamp 20A 雙極開關掣							1	1	

#### Notes:

- The residential floors start from 7/F in all towers of the Development.
- There is no Tower 4 in the Development.
- There are no 4/F, 13/F, 14/F, 24/F and 34/F in all towers of the Development.
- There are no 6/F and 19/F in Tower 1 and Tower 2 and no 20/F and 21/F in Tower 6, Tower 7, Tower 9 and Tower 10.
- There are no 2/F in Tower 3, Tower 5, Tower 6, Tower 7, Tower 8, Tower 9 and Tower 10.
- The symbol “-” as shown in the above table denotes “Not Provided”.
- The cells shaded in grey “■” as shown in the above table denotes “Not Applicable”.

#### 備註：

- 發展項目內所有座樓之住宅由7樓開始。
- 發展項目不設第4座。
- 發展項目內所有座樓均不設4樓、13樓、14樓、24樓及34樓。
- 第1座及第2座均不設6樓及19樓；第6座、第7座、第9座及第10座均不設20樓及21樓。
- 第3座、第5座、第6座、第7座、第8座、第9座及第10座均不設2樓。
- 上表內之“-”符號代表“沒有提供”。
- 上表內填上灰色“■”之部分代表“不適用”。

# FITTINGS, FINISHES AND APPLIANCES

## 裝置、裝修物料及設備

### Schedule of Mechanical and Electrical Provisions 機電裝置數量說明表

#### Tower 1 第1座

Location 位置	Exposed Type 外露型	Non-Exposed Type 非外露型	7/F 7樓		8/F to 18/F & 22/F to 36/F 8樓至18樓及22樓至36樓		20/F to 21/F 20樓至21樓	37/F 37樓	38/F 38樓	39/F 39樓	
			A	B	A	B	A	A	A	A	
Family Room 家庭室	TV/ FM Outlet 電視 / 電台天線插座									1	
	Telephone Outlet 電話插座									1	
	13A Twin Socket Outlet 13A雙位電插座									2	
	Lighting Switch 燈掣									3	
		Door Bell 門鐘									1
		Fused Spur Unit/Connection Unit 接線座									1
Store 士多房	13A Twin Socket Outlet 13A雙位電插座									1	
	Lighting Switch 燈掣									1	
Bathroom in Master Bedroom 主人房內之浴室	TV / FM Outlet 電視/電台天線插座		2	1	2	1	2	2		2	
	13A Twin Socket Outlet 13A雙位電插座		1	-	1	-	1	-		-	
	13A Single Socket Outlet 13A單位電插座		2	3	2	3	2	6		6	
		Fused Spur Unit/Connection Unit接線座		1	1	1	1	1		1	

#### Notes:

- The residential floors start from 7/F in all towers of the Development.
- There is no Tower 4 in the Development.
- There are no 4/F, 13/F, 14/F, 24/F and 34/F in all towers of the Development.
- There are no 6/F and 19/F in Tower 1 and Tower 2 and no 20/F and 21/F in Tower 6, Tower 7, Tower 9 and Tower 10.
- There are no 2/F in Tower 3, Tower 5, Tower 6, Tower 7, Tower 8, Tower 9 and Tower 10.
- The symbol “-” as shown in the above table denotes “Not Provided”.
- The cells shaded in grey “■” as shown in the above table denotes “Not Applicable”.

#### 備註：

- 發展項目內所有座樓之住宅由7樓開始。
- 發展項目不設第4座。
- 發展項目內所有座樓均不設4樓、13樓、14樓、24樓及34樓。
- 第1座及第2座均不設6樓及19樓；第6座、第7座、第9座及第10座均不設20樓及21樓。
- 第3座、第5座、第6座、第7座、第8座、第9座及第10座均不設2樓。
- 上表內之“-”符號代表“沒有提供”。
- 上表內填上灰色“■”之部分代表“不適用”。

# FITTINGS, FINISHES AND APPLIANCES

## 裝置、裝修物料及設備

### Schedule of Mechanical and Electrical Provisions

#### 機電裝置數量說明表

#### Tower 1 第1座

Location 位置	Exposed Type 外露型	Non-Exposed Type 非外露型	7/F 7樓		8/F to 18/F & 22/F to 36/F 8樓至18樓及22樓至36樓		20/F to 21/F 20樓至21樓	37/F 37樓	38/F 38樓	39/F 39樓
			A	B	A	B	A	A	A	A
Bathroom in Ensuite Bedroom / Ensuite Bedroom 1 套房 / 套房1內之 浴室	13A Single Socket Outlet 13A單位電插座		1	1	1	1	1	1	1	
		Fused Spur Unit/Connection Unit接線座	1	1	1	1	1	1	1	
Bathroom 浴室	13A Single Socket Outlet 13A單位電插座		1	1	1	1	1	1	1	
		Fused Spur Unit/Connection Unit接線座	1	1	1	1	1	1	1	
Bathroom in Ensuite Bedroom 2 套房2內之浴室	13A Single Socket Outlet 13A單位電插座							1	1	
		Fused Spur Unit/Connection Unit接線座						1	1	
Lavatory near to Living Room 鄰近客廳之 洗手間	13A Single Socket Outlet 13A單位電插座							1	1	
		Fused Spur Unit/Connection Unit 接線座						1	1	
Lavatory leading from Kitchen 由廚房通往之 洗手間		Fused Spur Unit/Connection Unit 接線座	1	1	1	1	1	1	1	

#### Notes:

- The residential floors start from 7/F in all towers of the Development.
- There is no Tower 4 in the Development.
- There are no 4/F, 13/F, 14/F, 24/F and 34/F in all towers of the Development.
- There are no 6/F and 19/F in Tower 1 and Tower 2 and no 20/F and 21/F in Tower 6, Tower 7, Tower 9 and Tower 10.
- There are no 2/F in Tower 3, Tower 5, Tower 6, Tower 7, Tower 8, Tower 9 and Tower 10.
- The symbol “-” as shown in the above table denotes “Not Provided”.
- The cells shaded in grey “■” as shown in the above table denotes “Not Applicable”.

#### 備註：

- 發展項目內所有座樓之住宅由7樓開始。
- 發展項目不設第4座。
- 發展項目內所有座樓均不設4樓、13樓、14樓、24樓及34樓。
- 第1座及第2座均不設6樓及19樓；第6座、第7座、第9座及第10座均不設20樓及21樓。
- 第3座、第5座、第6座、第7座、第8座、第9座及第10座均不設2樓。
- 上表內之“-”符號代表“沒有提供”。
- 上表內填上灰色“■”之部分代表“不適用”。

# FITTINGS, FINISHES AND APPLIANCES

## 裝置、裝修物料及設備

### Schedule of Mechanical and Electrical Provisions 機電裝置數量說明表

#### Tower 1 第1座

Location 位置	Exposed Type 外露型	Non-Exposed Type 非外露型	7/F 7樓		8/F to 18/F & 22/F to 36/F 8樓至18樓及22樓至36樓		20/F to 21/F 20樓至21樓	37/F 37樓	38/F 38樓	39/F 39樓
			A	B	A	B	A	A	A	A
Kitchen 廚房	TV/ FM Outlet 電視/電台天線插座		1	1	1	1	1	1	1	
	Telephone Outlet 電話插座		1	1	1	1	1	1	1	
	13A Twin Socket Outlet 13A雙位電插座		3	3	3	3	3	6	6	
		13A Single Socket Outlet 13A單位電插座	7	7	7	7	7	9	9	
	Lighting Switch 燈掣		5	5	4	4	4	3	3	
		Door Bell 門鐘	1	1	1	1	1	1	1	
	Door Phone Handset 對講機		1	1	1	1	1	1	1	
		20A Double Pole Switch with Pilot Lamp 20A 雙極開關掣	2	2	2	3	2	3	3	
		30A Double Pole Switch with Pilot Lamp 30A 雙極開關掣	1	1	1	1	1	1	1	
		Fused Spur Unit/Connection Unit 接線座	3	3	3	3	3	3	3	
		Drain Point For Washing Machine 去水位供洗衣機	1	1	1	1	1	1	1	
	Water Point For Washing Machine 來水位供洗衣機	1	1	1	1	1	1	1		
Flat Roof 平台	13A Weather Proof Single / Twin Socket Outlet 13A 防水單位/雙位電插座		2	1				1	2	1
Roof 天台	13A Weather Proof Single / Twin Socket Outlet 13A 防水單位/雙位電插座									1

#### Notes:

- The residential floors start from 7/F in all towers of the Development.
- There is no Tower 4 in the Development.
- There are no 4/F, 13/F, 14/F, 24/F and 34/F in all towers of the Development.
- There are no 6/F and 19/F in Tower 1 and Tower 2 and no 20/F and 21/F in Tower 6, Tower 7, Tower 9 and Tower 10.
- There are no 2/F in Tower 3, Tower 5, Tower 6, Tower 7, Tower 8, Tower 9 and Tower 10.
- The symbol “-” as shown in the above table denotes “Not Provided”.
- The cells shaded in grey “■” as shown in the above table denotes “Not Applicable”.

#### 備註：

- 發展項目內所有座樓之住宅由7樓開始。
- 發展項目不設第4座。
- 發展項目內所有座樓均不設4樓、13樓、14樓、24樓及34樓。
- 第1座及第2座均不設6樓及19樓；第6座、第7座、第9座及第10座均不設20樓及21樓。
- 第3座、第5座、第6座、第7座、第8座、第9座及第10座均不設2樓。
- 上表內之“-”符號代表“沒有提供”。
- 上表內填上灰色“■”之部分代表“不適用”。

# FITTINGS, FINISHES AND APPLIANCES

## 裝置、裝修物料及設備

### Appliances Schedule 設備說明表

#### Tower 2 第2座

Location 位置	Appliances 設備	Brand Name 品牌名稱	7/F 7樓		8/F to 18/F & 22/F to 36/F 8樓至18樓及22樓至36樓		20/F to 21/F 20樓至21樓	37/F 37樓	38/F & 39/F 38樓及39樓
			A	B	A	B	A	A	A
			Model Number 產品型號						
Living Room, Dining Room & Corridor 客廳、飯廳 及走廊	Split Type Air-Conditioner 分體式冷氣機	Panasonic/ Hitachi* 日立 (only apply to the model number with*) (只適用於 註有“*” 的型號)	Indoor Unit 室內機		Indoor Unit 室內機		Indoor Unit 室內機	Indoor Unit 室內機	Indoor Unit 室內機
			CS-E23JD4H(2NOS.)/ CS-E15HD3EA / CS-E10HD3EA	CS-E23JD4H(2NOS.)/ RPI-1.5FSN2*/ CS-E10HD3EA	CS-E23JD4H(2NOS.)/ CS-E15HD3EA / CS-E10HD3EA	CS-E23JD4H(2NOS.)/ CS-E15HD3EA / CS-E10HD3EA	CS-E23JD4H(2NOS.)/ CS-E15HD3EA/ CS-E10HD3EA	CS-E23JD4H(3NOS.)/ CS-E9JD4H	CS-E23JD4H(3NOS.)/ CS-E9JD4H
			Outdoor Unit 室外機		Outdoor Unit 室外機		Outdoor Unit 室外機	Outdoor Unit 室外機	Outdoor Unit 室外機
			CU-E23JBH(2NOS.)/ CU-4E23JBE (Shared Outdoor Unit) (共用室外組件)/ CU-4E23JBE (Shared Outdoor Unit) (共用室外組件)	CU-E23JBH(2NOS.)/ RAS-BFSN1* (Shared Outdoor Unit) (共用室外組件)/ CU-4E23JBE (Shared Outdoor Unit) (共用室外組件)	CU-E23JBH(2NOS.)/ CU-4E23JBE (Shared Outdoor Unit) (共用室外組件)/ CU-4E23JBE (Shared Outdoor Unit) (共用室外組件)	CU-E23JBH(2NOS.)/ CU-4E23JBE (Shared Outdoor Unit) (共用室外組件)/ CU-4E23JBE (Shared Outdoor Unit) (共用室外組件)	CU-E23JBH(2NOS.)/ CU-4E23JBE (Shared Outdoor Unit) (共用室外組件)/ CU-4E23JBE	CU-E23JBH(3NOS.)/ CU-E9JBH	CU-E23JBH(3NOS.)/ CU-E9JBH
Master Bedroom 主人房	Split Type Air-Conditioner 分體式冷氣機	Panasonic/ Hitachi* 日立 (only apply to the model number with*) (只適用於 註有“*” 的型號)	Indoor Unit 室內機		Indoor Unit 室內機		Indoor Unit 室內機	Indoor Unit 室內機	Indoor Unit 室內機
			CS-E18JD4H(2NOS.)/ CS-E15HD3EA	RPI-2.0FSN2(2NOS.)*/ CS-E15HD3EA	CS-E18JD4H(2NOS.)/ CS-E15HD3EA	CS-E18JD4H(2NOS.)/ CS-E15HD3EA	CS-E18JD4H(2NOS.)/ CS-E15HD3EA	CS-E18JD4H (2NOS.)	CS-E18JD4H (2NOS.)
			Outdoor Unit 室外機		Outdoor Unit 室外機		Outdoor Unit 室外機	Outdoor Unit 室外機	Outdoor Unit 室外機
			CU-E18JBH(2NOS.)/ CU-4E23JBE (Shared Outdoor Unit) (共用室外組件)	RAS-BFSN1* (Shared Outdoor Unit) (共用室外組件)/ CU-4E23JBE (Shared Outdoor Unit) (共用室外組件)	CU-E18JBH(2NOS.)/ CU-4E23JBE (Shared Outdoor Unit) (共用室外組件)	CU-E18JBH(2NOS.)/ CU-4E23JBE (Shared Outdoor Unit) (共用室外組件)	CU-E18JBH(2NOS.)/ CU-4E23JBE (Shared Outdoor Unit) (共用室外組件)	CU-E18JBH(2NOS.)	CU-E18JBH(2NOS.)

The vendor undertakes that if lifts and appliances of the specified brand name or model number are not installed in the Development, lifts or appliances of comparable quality will be installed.  
賣方承諾如該發展項目中沒有安裝指明的品牌名稱或產品型號的升降機或設備，便會安裝品質相若的升降機或設備。

#### Notes:

- The residential floors start from 7/F in all towers of the Development.
- There is no Tower 4 in the Development.
- There are no 4/F, 13/F, 14/F, 24/F and 34/F in all towers of the Development.
- There are no 6/F and 19/F in Tower 1 and Tower 2 and no 20/F and 21/F in Tower 6, Tower 7, Tower 9 and Tower 10.
- There are no 2/F in Tower 3, Tower 5, Tower 6, Tower 7, Tower 8, Tower 9 and Tower 10.
- The symbol “-” as shown in the above table denotes “Not Provided”.
- The cells shaded in grey “■” as shown in the above table denotes “Not Applicable”.

#### 備註：

- 發展項目內所有座樓之住宅由7樓開始。
- 發展項目不設第4座。
- 發展項目內所有座樓均不設4樓、13樓、14樓、24樓及34樓。
- 第1座及第2座均不設6樓及19樓；第6座、第7座、第9座及第10座均不設20樓及21樓。
- 第3座、第5座、第6座、第7座、第8座、第9座及第10座均不設2樓。
- 上表內之“-”符號代表“沒有提供”。
- 上表內填上灰色“■”之部分代表“不適用”。



# FITTINGS, FINISHES AND APPLIANCES

## 裝置、裝修物料及設備

### Appliances Schedule 設備說明表

#### Tower 2 第2座

Location 位置	Appliances 設備	Brand Name 品牌名稱	7/F 7樓		8/F to 18/F & 22/F to 36/F 8樓至18樓及22樓至36樓		20/F to 21/F 20樓至21樓	37/F 37樓	38/F & 39/F 38樓及39樓
			A	B	A	B	A	A	A
			Model Number 產品型號						
Ensuite Bedroom / Ensuite Bedroom 1 套房/套房1	Split Type Air-Conditioner 分體式冷氣機	Panasonic/ Hitachi* 日立 (only apply to the model number with*) (只適用於 註有“*” 的型號)	Indoor Unit 室內機		Indoor Unit 室內機		Indoor Unit 室內機	Indoor Unit 室內機	Indoor Unit 室內機
			CS-E15HD3EA	RPI-1.5FSN2*	CS-E15HD3EA	CS-E15HD3EA	CS-E15HD3EA	CS-E18JD4H (2NOS.)	CS-E18JD4H (2NOS.)
			Outdoor Unit 室外機		Outdoor Unit 室外機		Outdoor Unit 室外機	Outdoor Unit 室外機	Outdoor Unit 室外機
			CU-4E23JBE (Shared Outdoor Unit) (共用室外組件)	RAS-BFSN1* (Shared Outdoor Unit) (共用室外組件)	CU-4E23JBE (Shared Outdoor Unit) (共用室外組件)	CU-4E23JBE (Shared Outdoor Unit) (共用室外組件)	CU-4E23JBE (Shared Outdoor Unit) (共用室外組件)	CU-E18JBH(2NOS.)	CU-E18JBH(2NOS.)
Ensuite Bedroom 2 套房2	Split Type Air-Conditioner 分體式冷氣機	Panasonic	Indoor Unit 室內機		Indoor Unit 室內機		Indoor Unit 室內機	Indoor Unit 室內機	Indoor Unit 室內機
								CS-E18JD4H	CS-E18JD4H
			Outdoor Unit 室外機		Outdoor Unit 室外機		Outdoor Unit 室外機	Outdoor Unit 室外機	Outdoor Unit 室外機
								CU-E18JBH	CU-E18JBH

The vendor undertakes that if lifts and appliances of the specified brand name or model number are not installed in the Development, lifts or appliances of comparable quality will be installed.  
賣方承諾如該發展項目中沒有安裝指明的品牌名稱或產品型號的升降機或設備，便會安裝品質相若的升降機或設備。

#### Notes:

- The residential floors start from 7/F in all towers of the Development.
- There is no Tower 4 in the Development.
- There are no 4/F, 13/F, 14/F, 24/F and 34/F in all towers of the Development.
- There are no 6/F and 19/F in Tower 1 and Tower 2 and no 20/F and 21/F in Tower 6, Tower 7, Tower 9 and Tower 10.
- There are no 2/F in Tower 3, Tower 5, Tower 6, Tower 7, Tower 8, Tower 9 and Tower 10.
- The symbol “-” as shown in the above table denotes “Not Provided”.
- The cells shaded in grey “■” as shown in the above table denotes “Not Applicable”.

#### 備註：

- 發展項目內所有座樓之住宅由7樓開始。
- 發展項目不設第4座。
- 發展項目內所有座樓均不設4樓、13樓、14樓、24樓及34樓。
- 第1座及第2座均不設6樓及19樓；第6座、第7座、第9座及第10座均不設20樓及21樓。
- 第3座、第5座、第6座、第7座、第8座、第9座及第10座均不設2樓。
- 上表內之“-”符號代表“沒有提供”。
- 上表內填上灰色“■”之部分代表“不適用”。

# FITTINGS, FINISHES AND APPLIANCES

## 裝置、裝修物料及設備

### Appliances Schedule 設備說明表

#### Tower 2 第2座

Location 位置	Appliances 設備	Brand Name 品牌名稱	7/F 7樓		8/F to 18/F & 22/F to 36/F 8樓至18樓及22樓至36樓		20/F to 21/F 20樓至21樓	37/F 37樓	38/F & 39/F 38樓及39樓
			A	B	A	B	A	A	A
			Model Number 產品型號						
Kitchen 廚房	Split Type Air-Conditioner 分體式冷氣機	Panasonic	Indoor Unit 室內機		Indoor Unit 室內機		Indoor Unit 室內機	Indoor Unit 室內機	Indoor Unit 室內機
			CS-E9JKEW/ CS-E15HD3EA	CS-E9JKEW/ CS-E15HD3EA	CS-E9JKEW/ CS-E15HD3EA	CS-E9JKEW/ CS-E15HD3EA	CS-E9JKEW/ CS-E15HD3EA	CS-E9JKEW/ CS-E15HD3EA	CS-E9JKEW/ CS-E15HD3EA
			Outdoor Unit 室外機		Outdoor Unit 室外機		Outdoor Unit 室外機	Outdoor Unit 室外機	Outdoor Unit 室外機
			CU-4E23JBE (Shared Outdoor Unit) 共用室外組件/ CU-4E23JBE (Shared Outdoor Unit) 共用室外組件)	CU-4E23JBE (Shared Outdoor Unit) 共用室外組件/ CU-4E23JBE (Shared Outdoor Unit) 共用室外組件)	CU-4E23JBE (Shared Outdoor Unit) 共用室外組件/ CU-4E23JBE (Shared Outdoor Unit) 共用室外組件)	CU-4E23JBE (Shared Outdoor Unit) 共用室外組件/ CU-4E23JBE (Shared Outdoor Unit) 共用室外組件)	CU-4E23JBE (Shared Outdoor Unit) 共用室外組件/ CU-4E23JBE (Shared Outdoor Unit) 共用室外組件)	CU-4E23JBE (Shared Outdoor Unit) 共用室外組件/ CU-4E23JBE (Shared Outdoor Unit) 共用室外組件)	CU-4E23JBE
Family Room 家庭室	Split Type Air-Conditioner 分體式冷氣機	Panasonic	Indoor Unit 室內機		Indoor Unit 室內機		Indoor Unit 室內機	Indoor Unit 室內機	Indoor Unit 室內機
									CS-E23JD4H
			Outdoor Unit 室外機		Outdoor Unit 室外機		Outdoor Unit 室外機	Outdoor Unit 室外機	Outdoor Unit 室外機
									CU-E23JBH
Living Room, Dining Room & Corridor 客廳、飯廳及 走廊	Door Bell 門鐘	Hager 海格	XC001	XC001	XC001	XC001	-	XC001	XC001

The vendor undertakes that if lifts and appliances of the specified brand name or model number are not installed in the Development, lifts or appliances of comparable quality will be installed.  
賣方承諾如該發展項目中沒有安裝指明的品牌名稱或產品型號的升降機或設備，便會安裝品質相若的升降機或設備。

#### Notes:

- The residential floors start from 7/F in all towers of the Development.
- There is no Tower 4 in the Development.
- There are no 4/F, 13/F, 14/F, 24/F and 34/F in all towers of the Development.
- There are no 6/F and 19/F in Tower 1 and Tower 2 and no 20/F and 21/F in Tower 6, Tower 7, Tower 9 and Tower 10.
- There are no 2/F in Tower 3, Tower 5, Tower 6, Tower 7, Tower 8, Tower 9 and Tower 10.
- The symbol “-” as shown in the above table denotes “Not Provided”.
- The cells shaded in grey “■” as shown in the above table denotes “Not Applicable”.

#### 備註：

- 發展項目內所有座樓之住宅由7樓開始。
- 發展項目不設第4座。
- 發展項目內所有座樓均不設4樓、13樓、14樓、24樓及34樓。
- 第1座及第2座均不設6樓及19樓；第6座、第7座、第9座及第10座均不設20樓及21樓。
- 第3座、第5座、第6座、第7座、第8座、第9座及第10座均不設2樓。
- 上表內之“-”符號代表“沒有提供”。
- 上表內填上灰色“■”之部分代表“不適用”。

# FITTINGS, FINISHES AND APPLIANCES

## 裝置、裝修物料及設備

### Appliances Schedule 設備說明表

#### Tower 2 第2座

Location 位置	Appliances 設備	Brand Name 品牌名稱	7/F 7樓		8/F to 18/F & 22/F to 36/F 8樓至18樓及22樓至36樓		20/F to 21/F 20樓至21樓	37/F 37樓	38/F & 39/F 38樓及39樓
			A	B	A	B	A	A	A
			Model Number 產品型號						
Kitchen 廚房	Cooker Hood 抽油煙機	Miele 美諾	DA422-4	DA422-4	DA422-4	DA422-4	DA422-4	DA422-4	DA422-4
	Gas Cooking Hob 煤氣煮食爐	Miele 美諾	CS1028 CS1013G	CS1028 CS1013G	CS1028 CS1013G	CS1028 CS1013G	CS1028 CS1013G	CS1028 CS1013G	CS1028 CS1013G
	Gas Water Heater 煤氣熱水爐	TGC	NJW160TFQL <sup>(1)</sup>	NJW160TFQL <sup>(1)</sup>	NJW160TFQL <sup>(1)</sup>	NJW160TFQL <sup>(1)</sup>	NJW160TFQL <sup>(1)</sup>	NJW220TFQL <sup>(3)</sup>	NJW220TFQL <sup>(4)</sup>
	Microwave Oven 微波爐	Miele 美諾	-	-	-	-	-	M8161-2	M8161-2
	Refrigerator 雪櫃	Siemens 西門子	-	-	-	-	-	KI38VA	KI38VA
		Sub-Zero	ICBBI-48S	ICBBI-48S	ICBBI-48S	ICBBI-48S	ICBBI-48S	ICBBI-48S	ICBBI-48S
	Washer/Dryer 洗衣/乾衣機	Miele 美諾	W1712/ T7744C	W1712/ T7744C	W1712/ T7744C	W1712/ T7744C	W1712/ T7744C	W3844/ T4804C	W3844/ T4804C
	Exhaust Fan 抽氣扇	Xpelair	GX 6	GX 6	GX 6	GX 6	GX 6	GX 9	GX 9
Electric Oven 電焗爐	Miele 美諾	H5981HP	H5981HP	H5981HP	H5981HP	H5981HP	H5981HP	H5981HP	

The vendor undertakes that if lifts and appliances of the specified brand name or model number are not installed in the Development, lifts or appliances of comparable quality will be installed.

賣方承諾如該發展項目中沒有安裝指明的品牌名稱或產品型號的升降機或設備，便會安裝品質相若的升降機或設備。

#### Notes:

- The residential floors start from 7/F in all towers of the Development.
  - There is no Tower 4 in the Development.
  - There are no 4/F, 13/F, 14/F, 24/F and 34/F in all towers of the Development.
  - There are no 6/F and 19/F in Tower 1 and Tower 2 and no 20/F and 21/F in Tower 6, Tower 7, Tower 9 and Tower 10.
  - There are no 2/F in Tower 3, Tower 5, Tower 6, Tower 7, Tower 8, Tower 9 and Tower 10.
  - The symbol “-” as shown in the above table denotes “Not Provided”.
  - The cells shaded in grey “■” as shown in the above table denotes “Not Applicable”.
- (1) : The gas water heater located at A/C room & served for Bathroom in Ensuite Bedroom / Ensuite Bedroom 1 and Kitchen  
 (2) : The gas water heater located at A/C room & served for Bathroom and Lavatory leading from Kitchen  
 (3) : The gas water heater located at A/C room & served for Lavatory leading from Kitchen, Kitchen and Bathroom  
 (4) : The gas water heater located at A/C room & served for Lavatory near to Living Room and Bathroom in Ensuite Bedroom 2

#### 備註：

- 發展項目內所有座樓之住宅由7樓開始。
  - 發展項目不設第4座。
  - 發展項目內所有座樓均不設4樓、13樓、14樓、24樓及34樓。
  - 第1座及第2座均不設6樓及19樓；第6座、第7座、第9座及第10座均不設20樓及21樓。
  - 第3座、第5座、第6座、第7座、第8座、第9座及第10座均不設2樓。
  - 上表內之“-”符號代表“沒有提供”。
  - 上表內填上灰色“■”之部分代表“不適用”。
- (1) : 該款煤氣熱水爐位於冷氣機房及供應熱水給套房/套房1內之浴室和廚房  
 (2) : 該款煤氣熱水爐位於冷氣機房及供應熱水給浴室和由廚房通往之洗手間  
 (3) : 該款煤氣熱水爐位於冷氣機房及供應熱水給由廚房通往之洗手間、廚房和浴室  
 (4) : 該款煤氣熱水爐位於冷氣機房及供應熱水給鄰近客廳之洗手間和套房2內之浴室

# FITTINGS, FINISHES AND APPLIANCES

## 裝置、裝修物料及設備

### Appliances Schedule 設備說明表

#### Tower 2 第2座

Location 位置	Appliances 設備	Brand Name 品牌名稱	7/F 7樓		8/F to 18/F & 22/F to 36/F 8樓至18樓及22樓至36樓		20/F to 21/F 20樓至21樓	37/F 37樓	38/F & 39/F 38樓及39樓
			A	B	A	B	A	A	A
			Model Number 產品型號						
Kitchen 廚房	Induction Hob 電磁爐	Miele 美諾	CS122II	CS122II	CS122II	CS122II	CS122II	CS122II	CS122II
	Steam Oven 電蒸爐	Miele 美諾	-	-	-	-	-	DGC5051	DGC5051
	Wine Cellar 酒櫃	Miele 美諾	KWT4154UG-1	KWT4154UG-1	KWT4154UG-1	KWT4154UG-1	KWT4154UG-1	KWT1611	KWT1611
	Dishwasher 洗碗碟機	Miele 美諾	-	-	-	-	-	G5570SCVi	G5570SCVi
	Door Bell 門鐘	Hager 海格	XC001	XC001	XC001	XC001	XC001	XC001	XC001
	Videophone 視像對講機	Bitron	AV2850/1	AV2850/1	AV2850/1	AV2850/1	AV2850/1	AV2850/1	AV2850/1
Bathroom in Master Bedroom 主人房內之浴室	15"LCD TV 15"液晶體電視	JSA	TMBG15	TMBG15	TMBG15	TMBG15	TMBG15	TMBG15	TMBG15
	10"LCD TV 10"液晶體電視	JSA	-	-	-	-	-	TMBG10i	TMBG10i
	Ceiling Speaker 揚聲器	OBT	701	701	701	701	701	-	-
		KEF	-	-	-	-	-	2 x Cs130.2FS	2 x Cs130.2FS

The vendor undertakes that if lifts and appliances of the specified brand name or model number are not installed in the Development, lifts or appliances of comparable quality will be installed.  
賣方承諾如該發展項目中沒有安裝指明的品牌名稱或產品型號的升降機或設備，便會安裝品質相若的升降機或設備。

#### Notes:

- The residential floors start from 7/F in all towers of the Development.
- There is no Tower 4 in the Development.
- There are no 4/F, 13/F, 14/F, 24/F and 34/F in all towers of the Development.
- There are no 6/F and 19/F in Tower 1 and Tower 2 and no 20/F and 21/F in Tower 6, Tower 7, Tower 9 and Tower 10.
- There are no 2/F in Tower 3, Tower 5, Tower 6, Tower 7, Tower 8, Tower 9 and Tower 10.
- The symbol "-" as shown in the above table denotes "Not Provided".
- The cells shaded in grey "■" as shown in the above table denotes "Not Applicable".

#### 備註：

- 發展項目內所有座樓之住宅由7樓開始。
- 發展項目不設第4座。
- 發展項目內所有座樓均不設4樓、13樓、14樓、24樓及34樓。
- 第1座及第2座均不設6樓及19樓；第6座、第7座、第9座及第10座均不設20樓及21樓。
- 第3座、第5座、第6座、第7座、第8座、第9座及第10座均不設2樓。
- 上表內之“-”符號代表“沒有提供”。
- 上表內填上灰色“■”之部分代表“不適用”。

# FITTINGS, FINISHES AND APPLIANCES

## 裝置、裝修物料及設備

### Appliances Schedule 設備說明表

#### Tower 2 第2座

Location 位置	Appliances 設備	Brand Name 品牌名稱	7/F 7樓		8/F to 18/F & 22/F to 36/F 8樓至18樓及22樓至36樓		20/F to 21/F 20樓至21樓	37/F 37樓	38/F & 39/F 38樓及39樓
			A	B	A	B	A	A	A
			Model Number 產品型號						
Bathroom in Master Bedroom 主人房內之浴室	Gas Water Heater 煤氣熱水爐	TGC	NJW220TFQL	NJW220TFQL	NJW220TFQL	NJW220TFQL	NJW220TFQL	NJW220TFQL	NJW220TFQL
	Exhaust Fan 抽氣扇	Ostberg 奧斯博格	REF-2000B	REF-2000B	REF-2000B	REF-2000B	REF-2000B	REF-2000B	REF 200B
Bathroom in Ensuite Bedroom / Ensuite Bedroom 1 套房 / 套房1內 之浴室	Gas Water Heater 煤氣熱水爐	TGC	NJW160TFQL <sup>(1)</sup>	NJW160TFQL <sup>(1)</sup>	NJW160TFQL <sup>(1)</sup>	NJW160TFQL <sup>(1)</sup>	NJW160TFQL <sup>(1)</sup>	NJW220TFQL	NJW220TFQL
	Exhaust Fan 抽氣扇	Ostberg 奧斯博格	REF 140A	REF 140A	REF 140A	REF 140A	REF 140A	REF 140B	REF 140B
Bathroom in Ensuite Bedroom 2 套房2內之浴室	Gas Water Heater 煤氣熱水爐	TGC						NJW220TFQL <sup>(4)</sup>	NJW220TFQL <sup>(4)</sup>
	Exhaust Fan 抽氣扇	Ostberg 奧斯博格						RFE 140A	RFE 140A

The vendor undertakes that if lifts and appliances of the specified brand name or model number are not installed in the Development, lifts or appliances of comparable quality will be installed.  
賣方承諾如該發展項目中沒有安裝指明的品牌名稱或產品型號的升降機或設備，便會安裝品質相若的升降機或設備。

#### Notes:

- The residential floors start from 7/F in all towers of the Development.
  - There is no Tower 4 in the Development.
  - There are no 4/F, 13/F, 14/F, 24/F and 34/F in all towers of the Development.
  - There are no 6/F and 19/F in Tower 1 and Tower 2 and no 20/F and 21/F in Tower 6, Tower 7, Tower 9 and Tower 10.
  - There are no 2/F in Tower 3, Tower 5, Tower 6, Tower 7, Tower 8, Tower 9 and Tower 10.
  - The symbol “-” as shown in the above table denotes “Not Provided”.
  - The cells shaded in grey “■” as shown in the above table denotes “Not Applicable”.
- (1) : The gas water heater located at A/C room & served for Bathroom in Ensuite Bedroom / Ensuite Bedroom 1 and Kitchen  
(2) : The gas water heater located at A/C room & served for Bathroom and Lavatory leading from Kitchen  
(3) : The gas water heater located at A/C room & served for Lavatory leading from Kitchen, Kitchen and Bathroom  
(4) : The gas water heater located at A/C room & served for Lavatory near to Living Room and Bathroom in Ensuite Bedroom 2

#### 備註：

- 發展項目內所有座樓之住宅由7樓開始。
  - 發展項目不設第4座。
  - 發展項目內所有座樓均不設4樓、13樓、14樓、24樓及34樓。
  - 第1座及第2座均不設6樓及19樓；第6座、第7座、第9座及第10座均不設20樓及21樓。
  - 第3座、第5座、第6座、第7座、第8座、第9座及第10座均不設2樓。
  - 上表內之“-”符號代表“沒有提供”。
  - 上表內填上灰色“■”之部分代表“不適用”。
- (1) : 該款煤氣熱水爐位於冷氣機房及供應熱水給套房/套房1內之浴室和廚房  
(2) : 該款煤氣熱水爐位於冷氣機房及供應熱水給浴室和由廚房通往之洗手間  
(3) : 該款煤氣熱水爐位於冷氣機房及供應熱水給由廚房通往之洗手間、廚房和浴室  
(4) : 該款煤氣熱水爐位於冷氣機房及供應熱水給鄰近客廳之洗手間和套房2內之浴室

# FITTINGS, FINISHES AND APPLIANCES

## 裝置、裝修物料及設備

### Appliances Schedule 設備說明表

#### Tower 2 第2座

Location 位置	Appliances 設備	Brand Name 品牌名稱	7/F 7樓		8/F to 18/F & 22/F to 36/F 8樓至18樓及22樓至36樓		20/F to 21/F 20樓至21樓	37/F 37樓	38/F & 39/F 38樓及39樓
			A	B	A	B	A	A	A
			Model Number 產品型號						
Bathroom 浴室	Gas Water Heater 煤氣熱水爐	TGC	NJW160TFQL <sup>(2)</sup>	NJW160TFQL <sup>(2)</sup>	NJW160TFQL <sup>(2)</sup>	NJW160TFQL <sup>(2)</sup>	NJW160TFQL <sup>(2)</sup>	NJW220TFQL <sup>(3)</sup>	NJW220TFQL <sup>(3)</sup>
	Exhaust Fan 抽氣扇	Xpelair	GX 6	-	GX 6	-	GX 6	-	-
		Ostberg 奧斯博格	-	REF140A	-	REF140A	-	RFE 140B	RFE 140A
Lavatory near to Living Room 鄰近客廳之 洗手間	Gas Water Heater 煤氣熱水爐	TGC						NJW220TFQL <sup>(4)</sup>	NJW220TFQL <sup>(4)</sup>
	Exhaust Fan 抽氣扇	Xpelair						RFE 140A	RFE 140A
Lavatory leading from Kitchen 由廚房通往之 洗手間	Gas Water Heater 煤氣熱水爐	TGC	NJW160TFQL <sup>(2)</sup>	NJW160TFQL <sup>(2)</sup>	NJW160TFQL <sup>(2)</sup>	NJW160TFQL <sup>(2)</sup>	NJW160TFQL <sup>(2)</sup>	NJW220TFQL <sup>(3)</sup>	NJW220TFQL <sup>(3)</sup>
	Exhaust Fan 抽氣扇	Xpelair	GX 6	GX 6	GX 6	GX 6	GX 6	GX 6	GX 6

The vendor undertakes that if lifts and appliances of the specified brand name or model number are not installed in the Development, lifts or appliances of comparable quality will be installed.  
賣方承諾如該發展項目中沒有安裝指明的品牌名稱或產品型號的升降機或設備，便會安裝品質相若的升降機或設備。

#### Notes:

- The residential floors start from 7/F in all towers of the Development.
  - There is no Tower 4 in the Development.
  - There are no 4/F, 13/F, 14/F, 24/F and 34/F in all towers of the Development.
  - There are no 6/F and 19/F in Tower 1 and Tower 2 and no 20/F and 21/F in Tower 6, Tower 7, Tower 9 and Tower 10.
  - There are no 2/F in Tower 3, Tower 5, Tower 6, Tower 7, Tower 8, Tower 9 and Tower 10.
  - The symbol “-” as shown in the above table denotes “Not Provided”.
  - The cells shaded in grey “■” as shown in the above table denotes “Not Applicable”.
- (1): The gas water heater located at A/C room & served for Bathroom in Ensuite Bedroom / Ensuite Bedroom 1 and Kitchen  
(2): The gas water heater located at A/C room & served for Bathroom and Lavatory leading from Kitchen  
(3): The gas water heater located at A/C room & served for Lavatory leading from Kitchen, Kitchen and Bathroom  
(4): The gas water heater located at A/C room & served for Lavatory near to Living Room and Bathroom in Ensuite Bedroom 2

#### 備註:

- 發展項目內所有座樓之住宅由7樓開始。
  - 發展項目不設第4座。
  - 發展項目內所有座樓均不設4樓、13樓、14樓、24樓及34樓。
  - 第1座及第2座均不設6樓及19樓；第6座、第7座、第9座及第10座均不設20樓及21樓。
  - 第3座、第5座、第6座、第7座、第8座、第9座及第10座均不設2樓。
  - 上表內之“-”符號代表“沒有提供”。
  - 上表內填上灰色“■”之部分代表“不適用”。
- (1): 該款煤氣熱水爐位於冷氣機房及供應熱水給套房/套房1內之浴室和廚房  
(2): 該款煤氣熱水爐位於冷氣機房及供應熱水給浴室和由廚房通往之洗手間  
(3): 該款煤氣熱水爐位於冷氣機房及供應熱水給由廚房通往之洗手間、廚房和浴室  
(4): 該款煤氣熱水爐位於冷氣機房及供應熱水給鄰近客廳之洗手間和套房2內之浴室

# FITTINGS, FINISHES AND APPLIANCES

## 裝置、裝修物料及設備

### Schedule of Mechanical and Electrical Provisions 機電裝置數量說明表

#### Tower 2 第2座

Location 位置	Exposed Type 外露型	Non-Exposed Type 非外露型	7/F 7樓		8/F to 18/F & 22/F to 36/F 8樓至18樓及22樓至36樓		20/F to 21/F 20樓至21樓	37/F 37樓	38/F 38樓	39/F 39樓	
			A	B	A	B	A	A	A	A	
Living Room, Dining Room & Corridor 客廳、飯廳及 走廊	TV/ FM Outlet 電視/電台天線插座		3	3	3	3	3	3	1		
	Telephone Outlet 電話插座		3	3	3	3	3	3	1		
	13A Twin Socket Outlet 13A雙位電插座		6	6	7	7	7	8	4		
	13A Single Socket Outlet 13A單位電插座		5	5	3	2	2	6	6		
	Lighting Switch 燈掣		7	7	7	7	7	10	9		
		Door Bell 門鐘		1	1	1	1	1	1	1	
		20A Double Pole Switch with Pilot Lamp 20A 雙極開關掣		1	1	1	1	1	2	2	
	Fused Spur Unit/Connection Unit 接線座		1	1	1	1	1	1	1		
Master Bedroom 主人房	TV/ FM Outlet 電視/電台天線插座		2	2	2	2	2	2		2	
	Telephone Outlet 電話插座		2	2	2	2	2	2		2	
	13A Twin Socket Outlet 13A雙位電插座		3	3	3	3	3	4		4	
	13A Single Socket Outlet 13A單位電插座		3	3	3	3	3	2		2	
	Lighting Switch 燈掣		4	4	4	4	4	4		3	
		20A Double Pole Switch with Pilot Lamp 20A 雙極開關掣		1	1	1	1	1	2		2

#### Notes:

- The residential floors start from 7/F in all towers of the Development.
- There is no Tower 4 in the Development.
- There are no 4/F, 13/F, 14/F, 24/F and 34/F in all towers of the Development.
- There are no 6/F and 19/F in Tower 1 and Tower 2 and no 20/F and 21/F in Tower 6, Tower 7, Tower 9 and Tower 10.
- There are no 2/F in Tower 3, Tower 5, Tower 6, Tower 7, Tower 8, Tower 9 and Tower 10.
- The symbol “-” as shown in the above table denotes “Not Provided”.
- The cells shaded in grey “■” as shown in the above table denotes “Not Applicable”.

#### 備註：

- 發展項目內所有座樓之住宅由7樓開始。
- 發展項目不設第4座。
- 發展項目內所有座樓均不設4樓、13樓、14樓、24樓及34樓。
- 第1座及第2座均不設6樓及19樓；第6座、第7座、第9座及第10座均不設20樓及21樓。
- 第3座、第5座、第6座、第7座、第8座、第9座及第10座均不設2樓。
- 上表內之“-”符號代表“沒有提供”。
- 上表內填上灰色“■”之部分代表“不適用”。

# FITTINGS, FINISHES AND APPLIANCES

## 裝置、裝修物料及設備

### Schedule of Mechanical and Electrical Provisions 機電裝置數量說明表

#### Tower 2 第2座

Location 位置	Exposed Type 外露型	Non-Exposed Type 非外露型	7/F 7樓		8/F to 18/F & 22/F to 36/F 8樓至18樓及22樓至36樓		20/F to 21/F 20樓至21樓	37/F 37樓	38/F 38樓	39/F 39樓
			A	B	A	B	A	A	A	A
Ensuite Bedroom / Ensuite Bedroom 1 套房/套房1	TV/ FM Outlet 電視/電台天線插座		1	1	1	1	1	2	2	
	Telephone Outlet 電話插座		1	1	1	1	1	2	2	
	13A Twin Socket Outlet 13A雙位電插座		2	2	2	2	2	3	3	
	13A Single Socket Outlet 13A單位電插座		1	1	1	1	1	1	1	
	Lighting Switch 燈掣		2	2	2	2	2	4	4	
	20A Double Pole Switch with Pilot Lamp 20A 雙極開關掣		1	1	1	1	1	1	1	
Ensuite Bedroom 2 套房2	TV/ FM Outlet 電視/電台天線插座							2	2	
	Telephone Outlet 電話插座							1	1	
	13A Twin Socket Outlet 13A雙位電插座							4	4	
	13A Single Socket Outlet 13A單位電插座							1	1	
	Lighting Switch 燈掣							2	2	
	20A Double Pole Switch with Pilot Lamp 20A 雙極開關掣							1	1	

#### Notes:

- The residential floors start from 7/F in all towers of the Development.
- There is no Tower 4 in the Development.
- There are no 4/F, 13/F, 14/F, 24/F and 34/F in all towers of the Development.
- There are no 6/F and 19/F in Tower 1 and Tower 2 and no 20/F and 21/F in Tower 6, Tower 7, Tower 9 and Tower 10.
- There are no 2/F in Tower 3, Tower 5, Tower 6, Tower 7, Tower 8, Tower 9 and Tower 10.
- The symbol “-” as shown in the above table denotes “Not Provided”.
- The cells shaded in grey “■” as shown in the above table denotes “Not Applicable”.

#### 備註:

- 發展項目內所有座樓之住宅由7樓開始。
- 發展項目不設第4座。
- 發展項目內所有座樓均不設4樓、13樓、14樓、24樓及34樓。
- 第1座及第2座均不設6樓及19樓；第6座、第7座、第9座及第10座均不設20樓及21樓。
- 第3座、第5座、第6座、第7座、第8座、第9座及第10座均不設2樓。
- 上表內之“-”符號代表“沒有提供”。
- 上表內填上灰色“■”之部分代表“不適用”。



# FITTINGS, FINISHES AND APPLIANCES

## 裝置、裝修物料及設備

### Schedule of Mechanical and Electrical Provisions 機電裝置數量說明表

#### Tower 2 第2座

Location 位置	Exposed Type 外露型	Non-Exposed Type 非外露型	7/F 7樓		8/F to 18/F & 22/F to 36/F 8樓至18樓及22樓至36樓		20/F to 21/F 20樓至21樓	37/F 37樓	38/F 38樓	39/F 39樓	
			A	B	A	B	A	A	A	A	
Family Room 家庭室	TV/ FM Outlet 電視/電台天線插座									1	
	Telephone Outlet 電話插座									1	
	13A Twin Socket Outlet 13A雙位電插座									2	
	Lighting Switch 燈掣									3	
		Door Bell 門鐘									1
		Fused Spur Unit/Connection Unit 接線座									1
Store 士多房	13A Twin Socket Outlet 13A雙位電插座									1	
	Lighting Switch 燈掣									1	
Bathroom in Master Bedroom 主人房內之浴室	TV / FM Outlet 電視/電台天線插座		1	1	1	1	1	2		2	
	13A Single Socket Outlet 13A單位電插座		3	3	1	2	1	6		6	
		Fused Spur Unit/Connection Unit接線座		1	1	1	1	1		1	
Bathroom in Ensuite Bedroom / Ensuite Bedroom 1 套房 / 套房1內之 浴室	13A Single Socket Outlet 13A單位電插座		1	1	1	1	1	1	1		
		Fused Spur Unit/Connection Unit接線座		1	1	1	1	1	1		
Bathroom 浴室	13A Single Socket Outlet 13A單位電插座		1	1	1	1	1	1	1		
		Fused Spur Unit/Connection Unit接線座		1	1	1	1	1	1		

#### Notes:

- The residential floors start from 7/F in all towers of the Development.
- There is no Tower 4 in the Development.
- There are no 4/F, 13/F, 14/F, 24/F and 34/F in all towers of the Development.
- There are no 6/F and 19/F in Tower 1 and Tower 2 and no 20/F and 21/F in Tower 6, Tower 7, Tower 9 and Tower 10.
- There are no 2/F in Tower 3, Tower 5, Tower 6, Tower 7, Tower 8, Tower 9 and Tower 10.
- The symbol “-” as shown in the above table denotes “Not Provided”.
- The cells shaded in grey “■” as shown in the above table denotes “Not Applicable”.

#### 備註：

- 發展項目內所有座樓之住宅由7樓開始。
- 發展項目不設第4座。
- 發展項目內所有座樓均不設4樓、13樓、14樓、24樓及34樓。
- 第1座及第2座均不設6樓及19樓；第6座、第7座、第9座及第10座均不設20樓及21樓。
- 第3座、第5座、第6座、第7座、第8座、第9座及第10座均不設2樓。
- 上表內之“-”符號代表“沒有提供”。
- 上表內填上灰色“■”之部分代表“不適用”。

# FITTINGS, FINISHES AND APPLIANCES

## 裝置、裝修物料及設備

### Schedule of Mechanical and Electrical Provisions 機電裝置數量說明表

#### Tower 2 第2座

Location 位置	Exposed Type 外露型	Non-Exposed Type 非外露型	7/F 7樓		8/F to 18/F & 22/F to 36/F 8樓至18樓及22樓至36樓		20/F to 21/F 20樓至21樓	37/F 37樓	38/F 38樓	39/F 39樓
			A	B	A	B	A	A	A	A
Bathroom in Ensuite Bedroom 2 套房2內之浴室	13A Single Socket Outlet 13A單位電插座							1	1	
	Fused Spur Unit/Connection Unit接線座							1	1	
Lavatory near to Living Room 鄰近客廳之 洗手間	13A Single Socket Outlet 13A單位電插座							1	1	
	Fused Spur Unit/Connection Unit 接線座							1	1	
Lavatory leading from Kitchen 由廚房通往之 洗手間	Fused Spur Unit/Connection Unit 接線座		1	1	1	1	1	1	1	
Kitchen 廚房	TV/ FM Outlet 電視/電台天線插座		1	1	1	1	1	1	1	
	Telephone Outlet 電話插座		1	1	1	1	1	1	1	
	13A Twin Socket Outlet 13A雙位電插座		3	3	3	3	3	6	6	
	13A Single Socket Outlet 13A單位電插座		7	7	7	7	7	9	9	
	Lighting Switch 燈掣		5	5	4	4	4	3	3	
	Door Bell 門鐘		1	1	1	1	1	1	1	

#### Notes:

- The residential floors start from 7/F in all towers of the Development.
- There is no Tower 4 in the Development.
- There are no 4/F, 13/F, 14/F, 24/F and 34/F in all towers of the Development.
- There are no 6/F and 19/F in Tower 1 and Tower 2 and no 20/F and 21/F in Tower 6, Tower 7, Tower 9 and Tower 10.
- There are no 2/F in Tower 3, Tower 5, Tower 6, Tower 7, Tower 8, Tower 9 and Tower 10.
- The symbol “-” as shown in the above table denotes “Not Provided”.
- The cells shaded in grey “■” as shown in the above table denotes “Not Applicable”.

#### 備註:

- 發展項目內所有座樓之住宅由7樓開始。
- 發展項目不設第4座。
- 發展項目內所有座樓均不設4樓、13樓、14樓、24樓及34樓。
- 第1座及第2座均不設6樓及19樓；第6座、第7座、第9座及第10座均不設20樓及21樓。
- 第3座、第5座、第6座、第7座、第8座、第9座及第10座均不設2樓。
- 上表內之“-”符號代表“沒有提供”。
- 上表內填上灰色“■”之部分代表“不適用”。

# FITTINGS, FINISHES AND APPLIANCES

## 裝置、裝修物料及設備

### Schedule of Mechanical and Electrical Provisions 機電裝置數量說明表

#### Tower 2 第2座

Location 位置	Exposed Type 外露型	Non-Exposed Type 非外露型	7/F 7樓		8/F to 18/F & 22/F to 36/F 8樓至18樓及22樓至36樓		20/F to 21/F 20樓至21樓	37/F 37樓	38/F 38樓	39/F 39樓
			A	B	A	B	A	A	A	A
Kitchen 廚房	Door Phone Handset 對講機		1	1	1	1	1	1	1	
		20A Double Pole Switch with Pilot Lamp 20A 雙極開關掣	2	2	2	3	2	3	3	
		30A Double Pole Switch with Pilot Lamp 30A 雙極開關掣	1	1	1	1	1	1	1	
		Fused Spur Unit / Connection Unit 接線座	3	3	3	3	3	3	3	
		Drain Point For Washing Machine 去水位供洗衣機	1	1	1	1	1	1	1	
		Water Point For Washing Machine 來水位供洗衣機	1	1	1	1	1	1	1	
Flat Roof 平台	13A Weather Proof Single / Twin Socket Outlet 13A 防水單位/雙位電插座		2	1				1	2	1
Roof 天台	13A Weather Proof Single / Twin Socket Outlet 13A 防水單位/雙位電插座									1

#### Notes:

- The residential floors start from 7/F in all towers of the Development.
- There is no Tower 4 in the Development.
- There are no 4/F, 13/F, 14/F, 24/F and 34/F in all towers of the Development.
- There are no 6/F and 19/F in Tower 1 and Tower 2 and no 20/F and 21/F in Tower 6, Tower 7, Tower 9 and Tower 10.
- There are no 2/F in Tower 3, Tower 5, Tower 6, Tower 7, Tower 8, Tower 9 and Tower 10.
- The symbol “-” as shown in the above table denotes “Not Provided”.
- The cells shaded in grey “■” as shown in the above table denotes “Not Applicable”.

#### 備註：

- 發展項目內所有座樓之住宅由7樓開始。
- 發展項目不設第4座。
- 發展項目內所有座樓均不設4樓、13樓、14樓、24樓及34樓。
- 第1座及第2座均不設6樓及19樓；第6座、第7座、第9座及第10座均不設20樓及21樓。
- 第3座、第5座、第6座、第7座、第8座、第9座及第10座均不設2樓。
- 上表內之“-”符號代表“沒有提供”。
- 上表內填上灰色“■”之部分代表“不適用”。

# FITTINGS, FINISHES AND APPLIANCES

## 裝置、裝修物料及設備

### Appliances Schedule 設備說明表

#### Tower 3 第3座

Location 位置	Appliances 設備	Brand Name 品牌名稱	7/F 7樓			8/F to 36/F 8樓至36樓			37/F to 38/F 37樓至38樓	37/F & 38/F 37樓及38樓
			A	B	C	A	B	C	A	C
			Model Number 產品型號							
Living Room, Dining Room & Corridor 客廳、飯廳 及走廊	Split Type Air-Conditioner 分體式冷氣機	Panasonic	Indoor Unit 室內機			Indoor Unit 室內機			Indoor Unit 室內機	Indoor Unit 室內機
			CS- E23JD4H(2NOS.)/ CS-E10HD3EA	CS- E23JD4H(2NOS.)/ CS-E10HD3EA	CS-E23JD4H	CS- E23JD4H(2NOS.)/ CS-E10HD3EA	CS- E23JD4H(2NOS.)/ CS-E10HD3EA	CS-E23JD4H	CS-E18JD4H/ CS- E23JD4H(2NOS.)	CS- E18JD4H(2NOS)
			Outdoor Unit 室外機			Outdoor Unit 室外機			Outdoor Unit 室外機	Outdoor Unit 室外機
			CU- E23JBH(2NOS.)/ CU-2E18CBPGW (Shared Outdoor Unit) (共用室外組件)	CU- E23JBH(2NOS.)/ CU-2E18CBPGW (Shared Outdoor Unit) (共用室外組件)	CU-E23JBH	CU- E23JBH(2NOS.)/ CU-2E18CBPGW (Shared Outdoor Unit) (共用室外組件)	CU- E23JBH(2NOS.)/ CU-2E18CBPGW (Shared Outdoor Unit) (共用室外組件)	CU-E23JBH/ CU-E23JBH(2NOS)	CU-E18JBH/ CU- E23JBH(2NOS)	CU- E18JBH(2NOS.)
Master Bedroom 主人房	Split Type Air-Conditioner 分體式冷氣機	Panasonic	Indoor Unit 室內機			Indoor Unit 室內機			Indoor Unit 室內機	Indoor Unit 室內機
			CS-E23JD4H/ CS-E10HD3EA	CS-E23JD4H/ CS-E10HD3EA	CS-E12JD4H	CS-E23JD4H/ CS-E10HD3EA	CS-E23JD4H/ CS-E10HD3EA	CS-E12JD4H	CS- E18JD4H(2NOS)	CS- E18JD4H(2NOS)
			Outdoor Unit 室外機			Outdoor Unit 室外機			Outdoor Unit 室外機	Outdoor Unit 室外機
			CU-E23JBH/ CU-2E18CBPGW (Shared Outdoor Unit) (共用室外組件)	CU-E23JBH/ CU-2E18CBPGW (Shared Outdoor Unit) (共用室外組件)	CU-E12JBH	CU-E23JBH/ CU-2E18CBPGW (Shared Outdoor Unit) (共用室外組件)	CU-E23JBH/ CU-2E18CBPGW (Shared Outdoor Unit) (共用室外組件)	CU-E12JBH	CU- E18JBH(2NOS)	CU- E18JBH(2NOS)

The vendor undertakes that if lifts and appliances of the specified brand name or model number are not installed in the Development, lifts or appliances of comparable quality will be installed.  
賣方承諾如該發展項目中沒有安裝指明的品牌名稱或產品型號的升降機或設備，便會安裝品質相若的升降機或設備。

#### Notes:

- The residential floors start from 7/F in all towers of the Development.
- There is no Tower 4 in the Development.
- There are no 4/F, 13/F, 14/F, 24/F and 34/F in all towers of the Development.
- There are no 6/F and 19/F in Tower 1 and Tower 2 and no 20/F and 21/F in Tower 6, Tower 7, Tower 9 and Tower 10.
- There are no 2/F in Tower 3, Tower 5, Tower 6, Tower 7, Tower 8, Tower 9 and Tower 10.
- The symbol “-” as shown in the above table denotes “Not Provided”.
- The cells shaded in grey “■” as shown in the above table denotes “Not Applicable”.

#### 備註：

- 發展項目內所有座樓之住宅由7樓開始。
- 發展項目不設4樓。
- 發展項目內所有座樓均不設4樓、13樓、14樓、24樓及34樓。
- 第1座及第2座均不設6樓及19樓；第6座、第7座、第9座及第10座均不設20樓及21樓。
- 第3座、第5座、第6座、第7座、第8座、第9座及第10座均不設2樓。
- 上表內之“-”符號代表“沒有提供”。
- 上表內填上灰色“■”之部分代表“不適用”。

# FITTINGS, FINISHES AND APPLIANCES

## 裝置、裝修物料及設備

### Appliances Schedule 設備說明表

#### Tower 3 第3座

Location 位置	Appliances 設備	Brand Name 品牌名稱	7/F 7樓			8/F to 36/F 8樓至36樓			37/F to 38/F 37樓至38樓	37/F & 38/F 37樓及38樓
			A	B	C	A	B	C	A	C
			Model Number 產品型號							
Bedroom 睡房	Split Type Air-Conditioner 分體式冷氣機	Panasonic	Indoor Unit 室內機			Indoor Unit 室內機			Indoor Unit 室內機	Indoor Unit 室內機
			CS-E12JD4H	CS-E12JD4H		CS-E12JD4H	CS-E12JD4H			
			Outdoor Unit 室外機			Outdoor Unit 室外機			Outdoor Unit 室外機	Outdoor Unit 室外機
			CU-E12JBH	CU-E12JBH		CU-E12JBH	CU-E12JBH			
Bedroom 1 睡房1	Split Type Air-Conditioner 分體式冷氣機	Panasonic	Indoor Unit 室內機			Indoor Unit 室內機			Indoor Unit 室內機	Indoor Unit 室內機
					CS-E9JKEW			CS-E9JKEW	CU-E12JD4H CS-E18JD4H	
			Outdoor Unit 室外機			Outdoor Unit 室外機			Outdoor Unit 室外機	Outdoor Unit 室外機
					CU-2E18CBPGW (Shared Outdoor Unit) (共用室外組件)			CU-2E18CBPGW (Shared Outdoor Unit) (共用室外組件)	CS-E12JD45/ CU-E18JBH	

The vendor undertakes that if lifts and appliances of the specified brand name or model number are not installed in the Development, lifts or appliances of comparable quality will be installed.  
賣方承諾如該發展項目中沒有安裝指明的品牌名稱或產品型號的升降機或設備，便會安裝品質相若的升降機或設備。

#### Notes:

- The residential floors start from 7/F in all towers of the Development.
- There is no Tower 4 in the Development.
- There are no 4/F, 13/F, 14/F, 24/F and 34/F in all towers of the Development.
- There are no 6/F and 19/F in Tower 1 and Tower 2 and no 20/F and 21/F in Tower 6, Tower 7, Tower 9 and Tower 10.
- There are no 2/F in Tower 3, Tower 5, Tower 6, Tower 7, Tower 8, Tower 9 and Tower 10.
- The symbol “-” as shown in the above table denotes “Not Provided”.
- The cells shaded in grey “■” as shown in the above table denotes “Not Applicable”.

#### 備註：

- 發展項目內所有座樓之住宅由7樓開始。
- 發展項目不設第4座。
- 發展項目內所有座樓均不設4樓、13樓、14樓、24樓及34樓。
- 第1座及第2座均不設6樓及19樓；第6座、第7座、第9座及第10座均不設20樓及21樓。
- 第3座、第5座、第6座、第7座、第8座、第9座及第10座均不設2樓。
- 上表內之“-”符號代表“沒有提供”。
- 上表內填上灰色“■”之部分代表“不適用”。

# FITTINGS, FINISHES AND APPLIANCES

## 裝置、裝修物料及設備

### Appliances Schedule 設備說明表

#### Tower 3 第3座

Location 位置	Appliances 設備	Brand Name 品牌名稱	7/F 7樓			8/F to 36/F 8樓至36樓			37/F to 38/F 37樓至38樓	37/F & 38/F 37樓及38樓
			A	B	C	A	B	C	A	C
			Model Number 產品型號							
Bedroom 2 睡房2	Split Type Air-Conditioner 分體式冷氣機	Panasonic	Indoor Unit 室內機			Indoor Unit 室內機			Indoor Unit 室內機	Indoor Unit 室內機
					CS-E9JKEW			CS-E9JKEW		
			Outdoor Unit 室外機			Outdoor Unit 室外機			Outdoor Unit 室外機	Outdoor Unit 室外機
					CU-2E18CBPGW (Shared Outdoor Unit) (共用室外組件)			CU-2E18CBPGW (Shared Outdoor Unit) (共用室外組件)		
Ensuite Bedroom 套房	Split Type Air-Conditioner 分體式冷氣機	Panasonic	Indoor Unit 室內機			Indoor Unit 室內機			Indoor Unit 室內機	Indoor Unit 室內機
									CS-E18JD4H	CS-E18JD4H
			Outdoor Unit 室外機			Outdoor Unit 室外機			Outdoor Unit 室外機	Outdoor Unit 室外機
									CU-E18JBH	CU-E18JBH

The vendor undertakes that if lifts and appliances of the specified brand name or model number are not installed in the Development, lifts or appliances of comparable quality will be installed.  
賣方承諾如該發展項目中沒有安裝指明的品牌名稱或產品型號的升降機或設備，便會安裝品質相若的升降機或設備。

#### Notes:

- The residential floors start from 7/F in all towers of the Development.
- There is no Tower 4 in the Development.
- There are no 4/F, 13/F, 14/F, 24/F and 34/F in all towers of the Development.
- There are no 6/F and 19/F in Tower 1 and Tower 2 and no 20/F and 21/F in Tower 6, Tower 7, Tower 9 and Tower 10.
- There are no 2/F in Tower 3, Tower 5, Tower 6, Tower 7, Tower 8, Tower 9 and Tower 10.
- The symbol “-” as shown in the above table denotes “Not Provided”.
- The cells shaded in grey “■” as shown in the above table denotes “Not Applicable”.

#### 備註：

- 發展項目內所有座樓之住宅由7樓開始。
- 發展項目不設第4座。
- 發展項目內所有座樓均不設4樓、13樓、14樓、24樓及34樓。
- 第1座及第2座均不設6樓及19樓；第6座、第7座、第9座及第10座均不設20樓及21樓。
- 第3座、第5座、第6座、第7座、第8座、第9座及第10座均不設2樓。
- 上表內之“-”符號代表“沒有提供”。
- 上表內填上灰色“■”之部分代表“不適用”。

# FITTINGS, FINISHES AND APPLIANCES

## 裝置、裝修物料及設備

### Appliances Schedule 設備說明表

#### Tower 3 第3座

Location 位置	Appliances 設備	Brand Name 品牌名稱	7/F 7樓			8/F to 36/F 8樓至36樓			37/F to 38/F 37樓至38樓	37/F & 38/F 37樓及38樓
			A	B	C	A	B	C	A	C
			Model Number 產品型號							
Kitchen 廚房	Split Type Air-Conditioner 分體式冷氣機	Panasonic	Indoor Unit 室內機			Indoor Unit 室內機			Indoor Unit 室內機	Indoor Unit 室內機
			CS-E15HD3EA	CS-E15HD3EA	-	CS-E15HD3EA	CS-E15HD3EA	-	CS-E15HD3EA	CS-E15HD3EA
			Outdoor Unit 室外機			Outdoor Unit 室外機			Outdoor Unit 室外機	Outdoor Unit 室外機
			CU-4E23JBE (Shared Outdoor Unit) (共用室外組件)	CU-4E23JBE (Shared Outdoor Unit) (共用室外組件)	-	CU-4E23JBE (Shared Outdoor Unit) (共用室外組件)	CU-4E23JBE (Shared Outdoor Unit) (共用室外組件)	-	CU-4E23JBE (Shared Outdoor Unit) (共用室外組件)	CU-4E23JBE (Shared Outdoor Unit) (共用室外組件)
Store 士多房	Split Type Air-Conditioner 分體式冷氣機	Panasonic	Indoor Unit 室內機			Indoor Unit 室內機			Indoor Unit 室內機	Indoor Unit 室內機
			CS-E9JKEW	CS-E9JKEW	CS-RE9JKA	CS-E9JKEW	CS-E9JKEW	CS-RE9JKA	CS-E9JKEW	CS-E9JKEW
			Outdoor Unit 室外機			Outdoor Unit 室外機			Outdoor Unit 室外機	Outdoor Unit 室外機
			CU-4E23JBE (Shared Outdoor Unit) (共用室外組件)	CU-4E23JBE (Shared Outdoor Unit) (共用室外組件)	CU-RE9JKA	CU-4E23JBE (Shared Outdoor Unit) (共用室外組件)	CU-4E23JBE (Shared Outdoor Unit) (共用室外組件)	CU-RE9JKA	CU-4E23JBE (Shared Outdoor Unit) (共用室外組件)	CU-4E23JBE (Shared Outdoor Unit) (共用室外組件)
Living Room, Dining Room & Corridor 客廳、飯廳及 走廊	Videophone 視像對講機	Bitron	AV2850/1	AV2850/1	AV2850/1	AV2850/1	AV2850/1	AV2850/1	-	-
	Door Bell 門鐘	Hager 海格	XC001	XC001	XC001	XC001	XC001	XC001	XC001	XC001

The vendor undertakes that if lifts and appliances of the specified brand name or model number are not installed in the Development, lifts or appliances of comparable quality will be installed.  
賣方承諾如該發展項目中沒有安裝指明的品牌名稱或產品型號的升降機或設備，便會安裝品質相若的升降機或設備。

#### Notes:

- The residential floors start from 7/F in all towers of the Development.
- There is no Tower 4 in the Development.
- There are no 4/F, 13/F, 14/F, 24/F and 34/F in all towers of the Development.
- There are no 6/F and 19/F in Tower 1 and Tower 2 and no 20/F and 21/F in Tower 6, Tower 7, Tower 9 and Tower 10.
- There are no 2/F in Tower 3, Tower 5, Tower 6, Tower 7, Tower 8, Tower 9 and Tower 10.
- The symbol “-” as shown in the above table denotes “Not Provided”.
- The cells shaded in grey “■” as shown in the above table denotes “Not Applicable”.

#### 備註：

- 發展項目內所有座樓之住宅由7樓開始。
- 發展項目不設第4座。
- 發展項目內所有座樓均不設4樓、13樓、14樓、24樓及34樓。
- 第1座及第2座均不設6樓及19樓；第6座、第7座、第9座及第10座均不設20樓及21樓。
- 第3座、第5座、第6座、第7座、第8座、第9座及第10座均不設2樓。
- 上表內之“-”符號代表“沒有提供”。
- 上表內填上灰色“■”之部分代表“不適用”。

# FITTINGS, FINISHES AND APPLIANCES

## 裝置、裝修物料及設備

### Appliances Schedule 設備說明表

#### Tower 3 第3座

Location 位置	Appliances 設備	Brand Name 品牌名稱	7/F 7樓			8/F to 36/F 8樓至36樓			37/F to 38/F 37樓至38樓	37/F & 38/F 37樓及38樓
			A	B	C	A	B	C	A	C
			Model Number 產品型號							
Kitchen 廚房	Cooker Hood 抽油煙機	Miele 美諾	DA3190	DA3190	DA3190	DA3190	DA3190	DA3190	DA422-4	DA422-4
	Gas Cooking Hob 煤氣煮食爐	Miele 美諾	CS1018G/ CS1013G	CS1018G/ CS1013G	CS1018G/ CS1013G	CS1018G/ CS1013G	CS1018G/ CS1013G	CS1018G/ CS1013G	CS1018G/ CS1013G	CS1018G/ CS1013G
	Gas Water Heater 煤氣熱水爐	TGC	NJW160TFQL <sup>(1)</sup>	NJW160TFQL <sup>(1)</sup>	NJW220TFQL <sup>(3)</sup>	NJW160TFQL <sup>(1)</sup>	NJW160TFQL <sup>(1)</sup>	NJW220TFQL <sup>(3)</sup>	NJW220TFQL <sup>(4)</sup>	NJW220TFQL <sup>(5)</sup>
	Microwave Oven 微波爐	Miele 美諾	M8161-2	M8161-2	M8161-2	M8161-2	M8161-2	M8161-2	M8161-2	M8161-2
	Refrigerator 雪櫃	Siemens 西門子	KI38VA/ KU15R	KI38VA/ KU15R	KI38VA	KI38VA/ KU15R	KI38VA/ KU15R	KI38VA	-	-
		Sub-Zero	-	-	-	-	-	-	ICBBI-42S	ICBBI-42S
	Washer/Dryer 洗衣/乾衣機	Miele 美諾	-	-	-	-	-	-	T4804C/ W3844	WT2789i
		Siemens 西門子	WK16D	WK16D	WK16D	WK16D	WK16D	WK16D	-	-
Exhaust Fan 抽氣扇	Xpelair	GX 6	GX 6	GX 6	GX 6	GX 6	GX 6	GX 6	GX 6	

The vendor undertakes that if lifts and appliances of the specified brand name or model number are not installed in the Development, lifts or appliances of comparable quality will be installed.  
賣方承諾如該發展項目中沒有安裝指明的品牌名稱或產品型號的升降機或設備，便會安裝品質相若的升降機或設備。

#### Notes:

- The residential floors start from 7/F in all towers of the Development.
  - There is no Tower 4 in the Development.
  - There are no 4/F, 13/F, 14/F, 24/F and 34/F in all towers of the Development.
  - There are no 6/F and 19/F in Tower 1 and Tower 2 and no 20/F and 21/F in Tower 6, Tower 7, Tower 9 and Tower 10.
  - There are no 2/F in Tower 3, Tower 5, Tower 6, Tower 7, Tower 8, Tower 9 and Tower 10.
  - The symbol “-” as shown in the above table denotes “Not Provided”.
  - The cells shaded in grey “■” as shown in the above table denotes “Not Applicable”.
- (1): The gas water heater located at A/C room & served for Bathroom and Kitchen  
 (2): The gas water heater located at A/C room & served for Bathroom in Bedroom and Lavatory leading from Kitchen  
 (3): The gas water heater located at A/C room & served for Bathroom and Lavatory near to Living Room  
 (4): The gas water heater located at A/C room & served for Lavatory leading from Kitchen, Kitchen and Bathroom in Ensuite Bedroom  
 (5): The gas water heater located at A/C room & served for Lavatory leading from Kitchen, Kitchen and Bathroom

#### 備註:

- 發展項目內所有座樓之住宅由7樓開始。
  - 發展項目不設第4座。
  - 發展項目內所有座樓均不設4樓、13樓、14樓、24樓及34樓。
  - 第1座及第2座均不設6樓及19樓；第6座、第7座、第9座及第10座均不設20樓及21樓。
  - 第3座、第5座、第6座、第7座、第8座、第9座及第10座均不設2樓。
  - 上表內之“-”符號代表“沒有提供”。
  - 上表內填上灰色“■”之部分代表“不適用”。
- (1): 該款煤氣熱水爐位於冷氣機房及供應熱水給浴室和廚房  
 (2): 該款煤氣熱水爐位於冷氣機房及供應熱水給睡房內之浴室和由廚房通往之洗手間  
 (3): 該款煤氣熱水爐位於冷氣機房及供應熱水給浴室和鄰近客廳之洗手間  
 (4): 該款煤氣熱水爐位於冷氣機房及供應熱水給由廚房通往之洗手間、廚房和套房內之浴室  
 (5): 該款煤氣熱水爐位於冷氣機房及供應熱水給由廚房通往之洗手間、廚房和浴室



# FITTINGS, FINISHES AND APPLIANCES

## 裝置、裝修物料及設備

### Appliances Schedule 設備說明表

#### Tower 3 第3座

Location 位置	Appliances 設備	Brand Name 品牌名稱	7/F 7樓			8/F to 36/F 8樓至36樓			37/F to 38/F 37樓至38樓	37/F & 38/F 37樓及38樓
			A	B	C	A	B	C	A	C
			Model Number 產品型號							
Kitchen 廚房	Induction Hob 電磁爐	Miele 美諾	CS1212	CS1212	-	CS1212	CS1212	-	CS1212	CS1212
	Steam Oven 電蒸爐	Miele 美諾	DGC5051	DGC5051	DGC5051	DGC5051	DGC5051	DGC5051	DGC5051	DGC5051
	Wine Cellar 酒櫃	Miele 美諾	KWT4154UG-1	KWT4154UG-1	KWT4154UG-1	KWT4154UG-1	KWT4154UG-1	KWT4154UG-1	KWT4154UG-1	KWT4154UG-1
	Door Bell 門鐘	Hager 海格	XC001	XC001	XC001	XC001	XC001	XC001	XC001	XC001
	Videophone 視像對講機	Bitron	-	-	-	-	-	-	AV2850/1	AV2850/1

The vendor undertakes that if lifts and appliances of the specified brand name or model number are not installed in the Development, lifts or appliances of comparable quality will be installed.  
賣方承諾如該發展項目中沒有安裝指明的品牌名稱或產品型號的升降機或設備，便會安裝品質相若的升降機或設備。

#### Notes:

- The residential floors start from 7/F in all towers of the Development.
- There is no Tower 4 in the Development.
- There are no 4/F, 13/F, 14/F, 24/F and 34/F in all towers of the Development.
- There are no 6/F and 19/F in Tower 1 and Tower 2 and no 20/F and 21/F in Tower 6, Tower 7, Tower 9 and Tower 10.
- There are no 2/F in Tower 3, Tower 5, Tower 6, Tower 7, Tower 8, Tower 9 and Tower 10.
- The symbol “-” as shown in the above table denotes “Not Provided”.
- The cells shaded in grey “■” as shown in the above table denotes “Not Applicable”.

#### 備註：

- 發展項目內所有座樓之住宅由7樓開始。
- 發展項目不設第4座。
- 發展項目內所有座樓均不設4樓、13樓、14樓、24樓及34樓。
- 第1座及第2座均不設6樓及19樓；第6座、第7座、第9座及第10座均不設20樓及21樓。
- 第3座、第5座、第6座、第7座、第8座、第9座及第10座均不設2樓。
- 上表內之“-”符號代表“沒有提供”。
- 上表內填上灰色“■”之部分代表“不適用”。

# FITTINGS, FINISHES AND APPLIANCES

## 裝置、裝修物料及設備

### Appliances Schedule 設備說明表

#### Tower 3 第3座

Location 位置	Appliances 設備	Brand Name 品牌名稱	7/F 7樓			8/F to 36/F 8樓至36樓			37/F to 38/F 37樓至38樓	37/F & 38/F 37樓及38樓
			A	B	C	A	B	C	A	C
			Model Number 產品型號							
Bathroom in Master Bedroom 主人房內之浴室	15"LCD TV 15"液晶電視	JSA	TMBG15	TMBG15	-	TMBG15	TMBG15	-	TMBG15	TMBG15
	10"LCD TV 10"液晶電視	JSA	-	-	TMBG10i	-	-	TMBG10i	TMBG10i	-
	Ceiling Speaker 揚聲器	KEF	-	-	-	-	-	-	2 x Cs130.2FS	2 x Cs130.2FS
	Gas Water Heater 煤氣熱水爐	TGC	NJW220TFQL	NJW220TFQL	NJW220TFQL	NJW220TFQL	NJW220TFQL	NJW220TFQL	NJW220TFQL	NJW220TFQL
	Exhaust Fan 抽氣扇	Xpelair	-	-	GX6	-	-	GX6	-	-
Ostberg 奧斯博格		RFE 200B	RFE 200B	-	RFE 200B	RFE 200B	-	RFE 200B	RFE 140B	
Bathroom in Ensuite Bedroom 套房內之浴室	Gas Water Heater 煤氣熱水爐	TGC							NJW220TFQL <sup>(4)</sup>	NJW160TFQL
	Exhaust Fan 抽氣扇	Ostberg 奧斯博格							RFE 140A	RFE 140B

The vendor undertakes that if lifts and appliances of the specified brand name or model number are not installed in the Development, lifts or appliances of comparable quality will be installed.  
賣方承諾如該發展項目中沒有安裝指明的品牌名稱或產品型號的升降機或設備，便會安裝品質相若的升降機或設備。

#### Notes:

- The residential floors start from 7/F in all towers of the Development.
  - There is no Tower 4 in the Development.
  - There are no 4/F, 13/F, 14/F, 24/F and 34/F in all towers of the Development.
  - There are no 6/F and 19/F in Tower 1 and Tower 2 and no 20/F and 21/F in Tower 6, Tower 7, Tower 9 and Tower 10.
  - There are no 2/F in Tower 3, Tower 5, Tower 6, Tower 7, Tower 8, Tower 9 and Tower 10.
  - The symbol "-" as shown in the above table denotes "Not Provided".
  - The cells shaded in grey "■" as shown in the above table denotes "Not Applicable".
- (1): The gas water heater located at A/C room & served for Bathroom and Kitchen  
 (2): The gas water heater located at A/C room & served for Bathroom in Bedroom and Lavatory leading from Kitchen  
 (3): The gas water heater located at A/C room & served for Bathroom and Lavatory near to Living Room  
 (4): The gas water heater located at A/C room & served for Lavatory leading from Kitchen, Kitchen and Bathroom in Ensuite Bedroom  
 (5): The gas water heater located at A/C room & served for Lavatory leading from Kitchen, Kitchen and Bathroom

#### 備註:

- 發展項目內所有座樓之住宅由7樓開始。
  - 發展項目不設第4座。
  - 發展項目內所有座樓均不設4樓、13樓、14樓、24樓及34樓。
  - 第1座及第2座均不設6樓及19樓；第6座、第7座、第9座及第10座均不設20樓及21樓。
  - 第3座、第5座、第6座、第7座、第8座、第9座及第10座均不設2樓。
  - 上表內之“-”符號代表“沒有提供”。
  - 上表內填上灰色“■”之部分代表“不適用”。
- (1): 該款煤氣熱水爐位於冷氣機房及供應熱水給浴室和廚房  
 (2): 該款煤氣熱水爐位於冷氣機房及供應熱水給睡房內之浴室和由廚房通往之洗手間  
 (3): 該款煤氣熱水爐位於冷氣機房及供應熱水給浴室和鄰近客廳之洗手間  
 (4): 該款煤氣熱水爐位於冷氣機房及供應熱水給由廚房通往之洗手間、廚房和套房內之浴室  
 (5): 該款煤氣熱水爐位於冷氣機房及供應熱水給由廚房通往之洗手間、廚房和浴室

# FITTINGS, FINISHES AND APPLIANCES

## 裝置、裝修物料及設備

### Appliances Schedule 設備說明表

#### Tower 3 第3座

Location 位置	Appliances 設備	Brand Name 品牌名稱	7/F 7樓			8/F to 36/F 8樓至36樓			37/F to 38/F 37樓至38樓	37/F & 38/F 37樓及38樓
			A	B	C	A	B	C	A	C
			Model Number 產品型號							
Bathroom in Bedroom 睡房內之浴室	Gas Water Heater 煤氣熱水爐	TGC	NJW160TFQL <sup>(2)</sup>	NJW160TFQL <sup>(2)</sup>		NJW160TFQL <sup>(2)</sup>	NJW160TFQL <sup>(2)</sup>			
	Exhaust Fan 抽氣扇	Ostberg 奧斯博格	RFE 140A	RFE 140A		RFE 140A	RFE 140A			
Bathroom 浴室	Gas Water Heater 煤氣熱水爐	TGC	NJW160TFQL <sup>(1)</sup>	NJW160TFQL <sup>(1)</sup>	NJW220TFQL <sup>(1)</sup>	NJW160TFQL <sup>(1)</sup>	NJW160TFQL <sup>(1)</sup>	NJW220TFQL <sup>(1)</sup>	NJW220TFQL <sup>(3)</sup>	NJW220TFQL <sup>(5)</sup>
	Exhaust Fan 抽氣扇	Ostberg 奧斯博格	RFE 140A	RFE 140A	RFE 140A	RFE 140A	RFE 140A	RFE 140A	RFE 140A	RFE 140B
Lavatory near to Living Room 鄰近客廳之 洗手間	Gas Water Heater 煤氣熱水爐	TGC							NJW220TFQL <sup>(3)</sup>	
	Exhaust Fan 抽氣扇	Ostberg 奧斯博格							RFE-140A	
Lavatory leading from Kitchen 由廚房通往之 洗手間	Gas Water Heater 煤氣熱水爐	TGC	NJW160TFQL <sup>(2)</sup>	NJW160TFQL <sup>(2)</sup>		NJW160TFQL <sup>(2)</sup>	NJW160TFQL <sup>(2)</sup>		NJW220TFQL <sup>(4)</sup>	NJW220TFQL <sup>(5)</sup>
	Exhaust Fan 抽氣扇	Xpelair	-	-		-	-		GX 6	-
		Ostberg 奧斯博格	RFE 140A	RFE 140A		RFE 140A	RFE 140A		-	RFE 140A

The vendor undertakes that if lifts and appliances of the specified brand name or model number are not installed in the Development, lifts or appliances of comparable quality will be installed.  
賣方承諾如該發展項目中沒有安裝指明的品牌名稱或產品型號的升降機或設備，便會安裝品質相若的升降機或設備。

#### Notes:

- The residential floors start from 7/F in all towers of the Development.
  - There is no Tower 4 in the Development.
  - There are no 4/F, 13/F, 14/F, 24/F and 34/F in all towers of the Development.
  - There are no 6/F and 19/F in Tower 1 and Tower 2 and no 20/F and 21/F in Tower 6, Tower 7, Tower 9 and Tower 10.
  - There are no 2/F in Tower 3, Tower 5, Tower 6, Tower 7, Tower 8, Tower 9 and Tower 10.
  - The symbol “-” as shown in the above table denotes “Not Provided”.
  - The cells shaded in grey “■” as shown in the above table denotes “Not Applicable”.
- (1) : The gas water heater located at A/C room & served for Bathroom and Kitchen  
(2) : The gas water heater located at A/C room & served for Bathroom in Bedroom and Lavatory leading from Kitchen  
(3) : The gas water heater located at A/C room & served for Bathroom and Lavatory near to Living Room  
(4) : The gas water heater located at A/C room & served for Lavatory leading from Kitchen, Kitchen and Bathroom in Ensuite Bedroom  
(5) : The gas water heater located at A/C room & served for Lavatory leading from Kitchen, Kitchen and Bathroom

#### 備註：

- 發展項目內所有座樓之住宅由7樓開始。
  - 發展項目不設第4座。
  - 發展項目內所有座樓均不設4樓、13樓、14樓、24樓及34樓。
  - 第1座及第2座均不設6樓及19樓；第6座、第7座、第9座及第10座均不設20樓及21樓。
  - 第3座、第5座、第6座、第7座、第8座、第9座及第10座均不設2樓。
  - 上表內之“-”符號代表“沒有提供”。
  - 上表內填上灰色“■”之部分代表“不適用”。
- (1) : 該款煤氣熱水爐位於冷氣機房及供應熱水給浴室和廚房  
(2) : 該款煤氣熱水爐位於冷氣機房及供應熱水給睡房內之浴室和由廚房通往之洗手間  
(3) : 該款煤氣熱水爐位於冷氣機房及供應熱水給浴室和鄰近客廳之洗手間  
(4) : 該款煤氣熱水爐位於冷氣機房及供應熱水給由廚房通往之洗手間、廚房和套房內之浴室  
(5) : 該款煤氣熱水爐位於冷氣機房及供應熱水給由廚房通往之洗手間、廚房和浴室

# FITTINGS, FINISHES AND APPLIANCES

## 裝置、裝修物料及設備

### Schedule of Mechanical and Electrical Provisions 機電裝置數量說明表

#### Tower 3 第3座

Location 位置	Exposed Type 外露型	Non-Exposed Type 非外露型	7/F 7樓			8/F to 36/F 8樓至36樓			37/F 37樓		38/F 38樓		
			A	B	C	A	B	C	A	C	A	C	
Living Room, Dining Room & Corridor 客廳、飯廳及 走廊	TV/ FM Outlet 電視/電台天線插座		3	3	2	3	3	2	2	2	2	-	
	Telephone Outlet 電話插座		2	2	2	2	2	2	2	2	2	-	
	13A Twin Socket Outlet 13A雙位電插座		5	5	2	6	6	5	4	4	4	-	
	13A Single Socket Outlet 13A單位電插座		5	5	5	4	4	3	4	3	4	1	
	Lighting Switch 燈掣		7	7	7	6	6	7	9	4	8	2	
		Door Bell 門鐘		1	1	1	1	1	1	1	-	1	1
		Door Phone Handset 對講機		1	1	1	1	1	1	-	-	-	-
		20A Double Pole Switch with Pilot Lamp 20A 雙極開關掣		2	2	2	2	2	2	2	1	2	-
	Fused Spur Unit/Connection Unit 接線座		1	1	1	1	1	1	1	-	1	1	
Master Bedroom 主人房	TV/ FM Outlet 電視/電台天線插座		2	2	1	2	2	1	2		2	2	
	Telephone Outlet 電話插座		2	2	1	2	2	1	2		2	2	
	13A Twin Socket Outlet 13A雙位電插座		3	3	3	3	3	3	4		4	4	
	13A Single Socket Outlet 13A單位電插座		3	2	1	3	2	1	3		3	3	
	Lighting Switch 燈掣		4	4	2	4	4	2	4		3	3	
	20A Double Pole Switch with Pilot Lamp 20A 雙極開關掣		1	1	1	1	1	1	2		2	2	

#### Notes:

- The residential floors start from 7/F in all towers of the Development.
- There is no Tower 4 in the Development.
- There are no 4/F, 13/F, 14/F, 24/F and 34/F in all towers of the Development.
- There are no 6/F and 19/F in Tower 1 and Tower 2 and no 20/F and 21/F in Tower 6, Tower 7, Tower 9 and Tower 10.
- There are no 2/F in Tower 3, Tower 5, Tower 6, Tower 7, Tower 8, Tower 9 and Tower 10.
- The symbol “-” as shown in the above table denotes “Not Provided”.
- The cells shaded in grey “■” as shown in the above table denotes “Not Applicable”.

#### 備註:

- 發展項目內所有座樓之住宅由7樓開始。
- 發展項目不設第4座。
- 發展項目內所有座樓均不設4樓、13樓、14樓、24樓及34樓。
- 第1座及第2座均不設6樓及19樓；第6座、第7座、第9座及第10座均不設20樓及21樓。
- 第3座、第5座、第6座、第7座、第8座、第9座及第10座均不設2樓。
- 上表內之“-”符號代表“沒有提供”。
- 上表內填上灰色“■”之部分代表“不適用”。

# FITTINGS, FINISHES AND APPLIANCES

## 裝置、裝修物料及設備

Schedule of Mechanical and Electrical Provisions  
機電裝置數量說明表

### Tower 3 第3座

Location 位置	Exposed Type 外露型	Non-Exposed Type 非外露型	7/F 7樓			8/F to 36/F 8樓至36樓			37/F 37樓		38/F 38樓	
			A	B	C	A	B	C	A	C	A	C
Bedroom 睡房	TV/ FM Outlet 電視/電台天線插座		1	1		1	1					
	Telephone Outlet 電話插座		1	1		1	1					
	13A Twin Socket Outlet 13A雙位電插座		2	2		2	2					
	13A Single Socket Outlet 13A單位電插座		1	1		1	1					
	Lighting Switch 燈掣		2	2		2	2					
	20A Double Pole Switch with Pilot Lamp 20A 雙極開關掣		1	1		1	1					
Bedroom 1 睡房1	TV/ FM Outlet 電視/電台天線插座				1			1	2		2	
	Telephone Outlet 電話插座				1			1	2		2	
	13A Twin Socket Outlet 13A雙位電插座				1			1	2		2	
	13A Single Socket Outlet 13A單位電插座				1			1	1		1	
	Lighting Switch 燈掣				1			1	2		2	
Bedroom 2 睡房2	TV/ FM Outlet 電視/電台天線插座				1			1				
	Telephone Outlet 電話插座				1			1				
	13A Twin Socket Outlet 13A雙位電插座				2			2				
	Lighting Switch 燈掣				1			1				

Notes:

- The residential floors start from 7/F in all towers of the Development.
- There is no Tower 4 in the Development.
- There are no 4/F, 13/F, 14/F, 24/F and 34/F in all towers of the Development.
- There are no 6/F and 19/F in Tower 1 and Tower 2 and no 20/F and 21/F in Tower 6, Tower 7, Tower 9 and Tower 10.
- There are no 2/F in Tower 3, Tower 5, Tower 6, Tower 7, Tower 8, Tower 9 and Tower 10.
- The symbol “-” as shown in the above table denotes “Not Provided”.
- The cells shaded in grey “■” as shown in the above table denotes “Not Applicable”.

備註：

- 發展項目內所有座樓之住宅由7樓開始。
- 發展項目不設第4座。
- 發展項目內所有座樓均不設4樓、13樓、14樓、24樓及34樓。
- 第1座及第2座均不設6樓及19樓；第6座、第7座、第9座及第10座均不設20樓及21樓。
- 第3座、第5座、第6座、第7座、第8座、第9座及第10座均不設2樓。
- 上表內之“-”符號代表“沒有提供”。
- 上表內填上灰色“■”之部分代表“不適用”。

# FITTINGS, FINISHES AND APPLIANCES

## 裝置、裝修物料及設備

### Schedule of Mechanical and Electrical Provisions 機電裝置數量說明表

#### Tower 3 第3座

Location 位置	Exposed Type 外露型	Non-Exposed Type 非外露型	7/F 7樓			8/F to 36/F 8樓至36樓			37/F 37樓		38/F 38樓	
			A	B	C	A	B	C	A	C	A	C
Ensuite Bedroom 套房	TV/ FM Outlet 電視/電台天線插座								2	2	2	2
	Telephone Outlet 電話插座								1	1	1	1
	13A Twin Socket Outlet 13A雙位電插座								4	2	4	2
	13A Single Socket Outlet 13A單位電插座								2	1	2	1
	Lighting Switch 燈掣								3	1	3	2
	20A Double Pole Switch with Pilot Lamp 20A 雙極開關掣								1	-	1	1
Store 士多房	TV/ FM Outlet 電視/電台天線插座		1	1	1	1	1	1	1	1	1	
	Telephone Outlet 電話插座		-	-	-	-	-	-	1	1	1	
	13A Twin Socket Outlet 13A雙位電插座		1	1	1	1	1	1	1	1	1	
	13A Single Socket Outlet 13A單位電插座		-	-	-	-	-	-	3	-	1	
	Lighting Switch 燈掣		1	1	1	1	1	1	3	1	3	
	20A Double Pole Switch with Pilot Lamp 20A 雙極開關掣		1	1	-	1	1	-	1	1	1	
Store under Staircase 樓梯下的 士多房	Lighting Switch 燈掣									1		

#### Notes:

- The residential floors start from 7/F in all towers of the Development.
- There is no Tower 4 in the Development.
- There are no 4/F, 13/F, 14/F, 24/F and 34/F in all towers of the Development.
- There are no 6/F and 19/F in Tower 1 and Tower 2 and no 20/F and 21/F in Tower 6, Tower 7, Tower 9 and Tower 10.
- There are no 2/F in Tower 3, Tower 5, Tower 6, Tower 7, Tower 8, Tower 9 and Tower 10.
- The symbol “-” as shown in the above table denotes “Not Provided”.
- The cells shaded in grey “■” as shown in the above table denotes “Not Applicable”.

#### 備註：

- 發展項目內所有座樓之住宅由7樓開始。
- 發展項目不設第4座。
- 發展項目內所有座樓均不設4樓、13樓、14樓、24樓及34樓。
- 第1座及第2座均不設6樓及19樓；第6座、第7座、第9座及第10座均不設20樓及21樓。
- 第3座、第5座、第6座、第7座、第8座、第9座及第10座均不設2樓。
- 上表內之“-”符號代表“沒有提供”。
- 上表內填上灰色“■”之部分代表“不適用”。

# FITTINGS, FINISHES AND APPLIANCES

## 裝置、裝修物料及設備

Schedule of Mechanical and Electrical Provisions  
機電裝置數量說明表

### Tower 3 第3座

Location 位置	Exposed Type 外露型	Non-Exposed Type 非外露型	7/F 7樓			8/F to 36/F 8樓至36樓			37/F 37樓		38/F 38樓	
			A	B	C	A	B	C	A	C	A	C
Bathroom in Master Bedroom 主人房內之浴室	TV / FM Outlet 電視/電台天線插座		1	1	1	1	1	1	2		2	1
	13A Single Socket Outlet 13A單位電插座		2	2	2	2	2	2	6		6	3
	Fused Spur Unit/Connection Unit接線座		1	1	1	1	1	1	1		1	1
Bathroom 浴室	13A Single Socket Outlet 13A單位電插座		1	1	1	1	1	1	1	1	1	1
	Fused Spur Unit/Connection Unit接線座		1	1	1	1	1	1	1	1	1	1
Bathroom in Bedroom 睡房內之浴室	13A Single Socket Outlet 13A單位電插座		1	1		1	1					
	Fused Spur Unit/Connection Unit接線座		1	1		1	1					
Bathroom in Ensuite Bedroom 套房內之浴室	13A Single Socket Outlet 13A單位電插座								1		1	
	Fused Spur Unit/Connection Unit接線座								1		1	
Lavatory near to Living Room 鄰近客廳之 洗手間	13A Single Socket Outlet 13A單位電插座								1		1	
	Fused Spur Unit / Connection Unit 接線座								1		1	
Lavatory leading from Kitchen 由廚房通往之 洗手間		Fused Spur Unit / Connection Unit 接線座	1	1		1	1		1	1	1	

Notes:

- The residential floors start from 7/F in all towers of the Development.
- There is no Tower 4 in the Development.
- There are no 4/F, 13/F, 14/F, 24/F and 34/F in all towers of the Development.
- There are no 6/F and 19/F in Tower 1 and Tower 2 and no 20/F and 21/F in Tower 6, Tower 7, Tower 9 and Tower 10.
- There are no 2/F in Tower 3, Tower 5, Tower 6, Tower 7, Tower 8, Tower 9 and Tower 10.
- The symbol “-” as shown in the above table denotes “Not Provided”.
- The cells shaded in grey “■” as shown in the above table denotes “Not Applicable”.

備註：

- 發展項目內所有座樓之住宅由7樓開始。
- 發展項目不設第4座。
- 發展項目內所有座樓均不設4樓、13樓、14樓、24樓及34樓。
- 第1座及第2座均不設6樓及19樓；第6座、第7座、第9座及第10座均不設20樓及21樓。
- 第3座、第5座、第6座、第7座、第8座、第9座及第10座均不設2樓。
- 上表內之“-”符號代表“沒有提供”。
- 上表內填上灰色“■”之部分代表“不適用”。

# FITTINGS, FINISHES AND APPLIANCES

## 裝置、裝修物料及設備

### Schedule of Mechanical and Electrical Provisions 機電裝置數量說明表

#### Tower 3 第3座

Location 位置	Exposed Type 外露型	Non-Exposed Type 非外露型	7/F 7樓			8/F to 36/F 8樓至36樓			37/F 37樓		38/F 38樓	
			A	B	C	A	B	C	A	C	A	C
Kitchen 廚房	13A Twin Socket Outlet 13A雙位電插座		2	2	2	2	2	2	3	2	3	
		13A Single Socket Outlet 13A單位電插座	7	7	7	7	7	7	7	7	7	
		Lighting Switch 燈掣	-	-	-	-	-	-	1	1	1	
		Door Bell 門鐘	1	1	1	1	1	1	1	1	1	
		Door Phone Handset 對講機	-	-	-	-	-	-	1	1	1	
		20A Double Pole Switch with Pilot Lamp 20A 雙極開關掣	1	1	1	1	1	1	3	2	3	
		Fused Spur Unit / Connection Unit 接線座	3	3	2	3	3	2	3	3	3	
		Drain Point For Washing Machine 去水位供洗衣機	1	1	1	1	1	1	1	1	1	
		Water Point For Washing Machine 來水位供洗衣機	1	1	1	1	1	1	1	1	1	
Stairhood 梯屋	Lighting Switch 燈掣										2	2
Flat Roof 平台	13A Weather Proof Single / Twin Socket Outlet 13A 防水單位/雙位電插座		2	2	1				1			1
Roof 天台	13A Weather Proof Single / Twin Socket Outlet 13A 防水單位/雙位電插座										1	1

#### Notes:

- The residential floors start from 7/F in all towers of the Development.
- There is no Tower 4 in the Development.
- There are no 4/F, 13/F, 14/F, 24/F and 34/F in all towers of the Development.
- There are no 6/F and 19/F in Tower 1 and Tower 2 and no 20/F and 21/F in Tower 6, Tower 7, Tower 9 and Tower 10.
- There are no 2/F in Tower 3, Tower 5, Tower 6, Tower 7, Tower 8, Tower 9 and Tower 10.
- The symbol “-” as shown in the above table denotes “Not Provided”.
- The cells shaded in grey “■” as shown in the above table denotes “Not Applicable”.

#### 備註：

- 發展項目內所有座樓之住宅由7樓開始。
- 發展項目不設第4座。
- 發展項目內所有座樓均不設4樓、13樓、14樓、24樓及34樓。
- 第1座及第2座均不設6樓及19樓；第6座、第7座、第9座及第10座均不設20樓及21樓。
- 第3座、第5座、第6座、第7座、第8座、第9座及第10座均不設2樓。
- 上表內之“-”符號代表“沒有提供”。
- 上表內填上灰色“■”之部分代表“不適用”。



# FITTINGS, FINISHES AND APPLIANCES

## 裝置、裝修物料及設備

### Appliances Schedule 設備說明表

#### Tower 5 第5座

Location 位置	Appliances 設備	Brand Name 品牌名稱	7/F 7樓			8/F to 37/F 8樓至37樓			38/F to 39/F 38樓至39樓	38/F & 39/F 38樓及39樓
			A	B	C	A	B	C	A	C
			Model Number 產品型號							
Living Room, Dining Room & Corridor 客廳、飯廳 及走廊	Split Type Air-Conditioner 分體式冷氣機	Panasonic	Indoor Unit 室內機			Indoor Unit 室內機			Indoor Unit 室內機	Indoor Unit 室內機
			CS- E18JD4H(2NOS.)/ CS-E10HD3EA	CS- E18JD4H(2NOS.)/ CS-E10HD3EA	CS-E23JD4H	CS- E18JD4H(2NOS.)/ CS-E10HD3EA	CS- E18JD4H(2NOS.)/ CS-E10HD3EA	CS-E23JD4H	CS- E18JD4H(3NOS)	CS- E18JD4H(2NOS)
			Outdoor Unit 室外機			Outdoor Unit 室外機			Outdoor Unit 室外機	Outdoor Unit 室外機
			CU- E18JBH(2NOS.)/ CU-2E18CBPGW (Shared Outdoor Unit) (共用室外組件)	CU- E18JBH(2NOS.)/ CU-2E18CBPGW (Shared Outdoor Unit) (共用室外組件)	CU-E23JBH	CU- E18JBH(2NOS.)/ CU-2E18CBPGW (Shared Outdoor Unit) (共用室外組件)	CU- E18JBH(2NOS.)/ CU-2E18CBPGW (Shared Outdoor Unit) (共用室外組件)	CU-E23JBH	CU- E18JBH(3NOS.)	CU- E18JBH(2NOS.)
Master Bedroom 主人房	Split Type Air-Conditioner 分體式冷氣機	Panasonic	Indoor Unit 室內機			Indoor Unit 室內機			Indoor Unit 室內機	Indoor Unit 室內機
			CS-E18JD4H/ CS-E10HD3EA	CS-E18JD4H/ CS-E10HD3EA	CS-E12JD4H	CS-E18JD4H/ CS-E10HD3EA	CS-E18JD4H/ CS-E10HD3EA	CS-E12JD4H	CS-E23JD4H	CS- E18JD4H(2NOS)
			Outdoor Unit 室外機			Outdoor Unit 室外機			Outdoor Unit 室外機	Outdoor Unit 室外機
			CU-E18JBH/ CU-2E18CBPGW (Shared Outdoor Unit) (共用室外組件)	CU-E18JBH/ CU-2E18CBPGW (Shared Outdoor Unit) (共用室外組件)	CU-E12JBH	CU-E18JBH/ CU-2E18CBPGW (Shared Outdoor Unit) (共用室外組件)	CU-E18JBH/ CU-2E18CBPGW (Shared Outdoor Unit) (共用室外組件)	CU-E12JBH	CU-E23JBH	CU- E18JBH(2NOS)

The vendor undertakes that if lifts and appliances of the specified brand name or model number are not installed in the Development, lifts or appliances of comparable quality will be installed.  
賣方承諾如該發展項目中沒有安裝指明的品牌名稱或產品型號的升降機或設備，便會安裝品質相若的升降機或設備。

#### Notes:

- The residential floors start from 7/F in all towers of the Development.
- There is no Tower 4 in the Development.
- There are no 4/F, 13/F, 14/F, 24/F and 34/F in all towers of the Development.
- There are no 6/F and 19/F in Tower 1 and Tower 2 and no 20/F and 21/F in Tower 6, Tower 7, Tower 9 and Tower 10.
- There are no 2/F in Tower 3, Tower 5, Tower 6, Tower 7, Tower 8, Tower 9 and Tower 10.
- The symbol “-” as shown in the above table denotes “Not Provided”.
- The cells shaded in grey “■” as shown in the above table denotes “Not Applicable”.

#### 備註：

- 發展項目內所有座樓之住宅由7樓開始。
- 發展項目不設第4座。
- 發展項目內所有座樓均不設4樓、13樓、14樓、24樓及34樓。
- 第1座及第2座均不設6樓及19樓；第6座、第7座、第9座及第10座均不設20樓及21樓。
- 第3座、第5座、第6座、第7座、第8座、第9座及第10座均不設2樓。
- 上表內之“-”符號代表“沒有提供”。
- 上表內填上灰色“■”之部分代表“不適用”。

# FITTINGS, FINISHES AND APPLIANCES

## 裝置、裝修物料及設備

### Appliances Schedule 設備說明表

#### Tower 5 第5座

Location 位置	Appliances 設備	Brand Name 品牌名稱	7/F 7樓			8/F to 37/F 8樓至37樓			38/F to 39/F 38樓至39樓	38/F & 39/F 38樓及39樓
			A	B	C	A	B	C	A	C
			Model Number 產品型號							
Bedroom 1 睡房1	Split Type Air-Conditioner 分體式冷氣機	Panasonic	Indoor Unit 室內機			Indoor Unit 室內機			Indoor Unit 室內機	Indoor Unit 室內機
					CS-E9JKEW			CS-E9JKEW	CS-E12JD4H/ CS-E18JD4H	
			Outdoor Unit 室外機			Outdoor Unit 室外機			Outdoor Unit 室外機	Outdoor Unit 室外機
					CU-2E18CBPGW (Shared Outdoor Unit) (共用室外組件)			CU-2E18CBPGW (Shared Outdoor Unit) (共用室外組件)	CU-E12JBH/ CU-E18JBH	
Bedroom 2 睡房2	Split Type Air-Conditioner 分體式冷氣機	Panasonic	Indoor Unit 室內機			Indoor Unit 室內機			Indoor Unit 室內機	Indoor Unit 室內機
					CS-E9JKEW			CS-E9JKEW		
			Outdoor Unit 室外機			Outdoor Unit 室外機			Outdoor Unit 室外機	Outdoor Unit 室外機
					CU-2E18CBPGW (Shared Outdoor Unit) (共用室外組件)			CU-2E18CBPGW (Shared Outdoor Unit) (共用室外組件)		

The vendor undertakes that if lifts and appliances of the specified brand name or model number are not installed in the Development, lifts or appliances of comparable quality will be installed.  
賣方承諾如該發展項目中沒有安裝指明的品牌名稱或產品型號的升降機或設備，便會安裝品質相若的升降機或設備。

#### Notes:

- The residential floors start from 7/F in all towers of the Development.
- There is no Tower 4 in the Development.
- There are no 4/F, 13/F, 14/F, 24/F and 34/F in all towers of the Development.
- There are no 6/F and 19/F in Tower 1 and Tower 2 and no 20/F and 21/F in Tower 6, Tower 7, Tower 9 and Tower 10.
- There are no 2/F in Tower 3, Tower 5, Tower 6, Tower 7, Tower 8, Tower 9 and Tower 10.
- The symbol “-” as shown in the above table denotes “Not Provided”.
- The cells shaded in grey “■” as shown in the above table denotes “Not Applicable”.

#### 備註：

- 發展項目內所有座樓之住宅由7樓開始。
- 發展項目不設第4座。
- 發展項目內所有座樓均不設4樓、13樓、14樓、24樓及34樓。
- 第1座及第2座均不設6樓及19樓；第6座、第7座、第9座及第10座均不設20樓及21樓。
- 第3座、第5座、第6座、第7座、第8座、第9座及第10座均不設2樓。
- 上表內之“-”符號代表“沒有提供”。
- 上表內填上灰色“■”之部分代表“不適用”。

# FITTINGS, FINISHES AND APPLIANCES

## 裝置、裝修物料及設備

### Appliances Schedule 設備說明表

#### Tower 5 第5座

Location 位置	Appliances 設備	Brand Name 品牌名稱	7/F 7樓			8/F to 37/F 8樓至37樓			38/F to 39/F 38樓至39樓	38/F & 39/F 38樓及39樓
			A	B	C	A	B	C	A	C
			Model Number 產品型號							
Ensuite Bedroom 套房	Split Type Air-Conditioner 分體式冷氣機	Panasonic	Indoor Unit 室內機			Indoor Unit 室內機			Indoor Unit 室內機	Indoor Unit 室內機
									CS-E18JD4H	CS-E18JD4H
			Outdoor Unit 室外機			Outdoor Unit 室外機			Outdoor Unit 室外機	Outdoor Unit 室外機
									CU-E18JBH	CU-E18JBH
Kitchen 廚房	Split Type Air-Conditioner 分體式冷氣機	Panasonic	Indoor Unit 室內機			Indoor Unit 室內機			Indoor Unit 室內機	Indoor Unit 室內機
			CS-E15HD3EA	CS-E15HD3EA	-	CS-E15HD3EA	CS-E15HD3EA	-	CS-E15HD3EA	CS-E15HD3EA
			Outdoor Unit 室外機			Outdoor Unit 室外機			Outdoor Unit 室外機	Outdoor Unit 室外機
			CU-4E23JBE (Shared Outdoor Unit) (共用室外組件)	CU-4E23JBE (Shared Outdoor Unit) (共用室外組件)	-	CU-4E23JBE (Shared Outdoor Unit) (共用室外組件)	CU-4E23JBE (Shared Outdoor Unit) (共用室外組件)	-	CU-4E23JBE (Shared Outdoor Unit) (共用室外組件)	CU-4E23JBE (Shared Outdoor Unit) (共用室外組件)

The vendor undertakes that if lifts and appliances of the specified brand name or model number are not installed in the Development, lifts or appliances of comparable quality will be installed.  
賣方承諾如該發展項目中沒有安裝指明的品牌名稱或產品型號的升降機或設備，便會安裝品質相若的升降機或設備。

#### Notes:

- The residential floors start from 7/F in all towers of the Development.
- There is no Tower 4 in the Development.
- There are no 4/F, 13/F, 14/F, 24/F and 34/F in all towers of the Development.
- There are no 6/F and 19/F in Tower 1 and Tower 2 and no 20/F and 21/F in Tower 6, Tower 7, Tower 9 and Tower 10.
- There are no 2/F in Tower 3, Tower 5, Tower 6, Tower 7, Tower 8, Tower 9 and Tower 10.
- The symbol “-” as shown in the above table denotes “Not Provided”.
- The cells shaded in grey “■” as shown in the above table denotes “Not Applicable”.

#### 備註：

- 發展項目內所有座樓之住宅由7樓開始。
- 發展項目不設第4座。
- 發展項目內所有座樓均不設4樓、13樓、14樓、24樓及34樓。
- 第1座及第2座均不設6樓及19樓；第6座、第7座、第9座及第10座均不設20樓及21樓。
- 第3座、第5座、第6座、第7座、第8座、第9座及第10座均不設2樓。
- 上表內之“-”符號代表“沒有提供”。
- 上表內填上灰色“■”之部分代表“不適用”。

# FITTINGS, FINISHES AND APPLIANCES

## 裝置、裝修物料及設備

### Appliances Schedule 設備說明表

#### Tower 5 第5座

Location 位置	Appliances 設備	Brand Name 品牌名稱	7/F 7樓			8/F to 37/F 8樓至37樓			38/F to 39/F 38樓至39樓	38/F & 39/F 38樓及39樓
			A	B	C	A	B	C	A	C
			Model Number 產品型號							
Store 士多房	Split Type Air-Conditioner 分體式冷氣機	Panasonic	Indoor Unit 室內機			Indoor Unit 室內機			Indoor Unit 室內機	Indoor Unit 室內機
			CS-E9JKEW	CS-E9JKEW	CS-RE9JKA	CS-E9JKEW	CS-E9JKEW	CS-RE9JKA	CS-E9JKEW	CS-E9JKEW
			Outdoor Unit 室外機			Outdoor Unit 室外機			Outdoor Unit 室外機	Outdoor Unit 室外機
			CU-4E23JBE (Shared Outdoor Unit) (共用室外組件)	CU-4E23JBE (Shared Outdoor Unit) (共用室外組件)	CU-RE9JKA	CU-4E23JBE (Shared Outdoor Unit) (共用室外組件)	CU-4E23JBE (Shared Outdoor Unit) (共用室外組件)	CU-RE9JKA	CU-4E23JBE (Shared Outdoor Unit) (共用室外組件)	CU-4E23JBE (Shared Outdoor Unit) (共用室外組件)
Living Room, Dining Room & Corridor 客廳、飯廳及 走廊	Videophone 視像對講機	Bitron	AV2850/1	AV2850/1	AV2850/1	AV2850/1	AV2850/1	AV2850/1	-	-
	Door Bell 門鐘	Hager 海格	XC001	XC001	XC001	XC001	XC001	XC001	XC001	XC001

The vendor undertakes that if lifts and appliances of the specified brand name or model number are not installed in the Development, lifts or appliances of comparable quality will be installed.  
賣方承諾如該發展項目中沒有安裝指明的品牌名稱或產品型號的升降機或設備，便會安裝品質相若的升降機或設備。

#### Notes:

- The residential floors start from 7/F in all towers of the Development.
- There is no Tower 4 in the Development.
- There are no 4/F, 13/F, 14/F, 24/F and 34/F in all towers of the Development.
- There are no 6/F and 19/F in Tower 1 and Tower 2 and no 20/F and 21/F in Tower 6, Tower 7, Tower 9 and Tower 10.
- There are no 2/F in Tower 3, Tower 5, Tower 6, Tower 7, Tower 8, Tower 9 and Tower 10.
- The symbol “-” as shown in the above table denotes “Not Provided”.
- The cells shaded in grey “■” as shown in the above table denotes “Not Applicable”.

#### 備註：

- 發展項目內所有座樓之住宅由7樓開始。
- 發展項目不設第4座。
- 發展項目內所有座樓均不設4樓、13樓、14樓、24樓及34樓。
- 第1座及第2座均不設6樓及19樓；第6座、第7座、第9座及第10座均不設20樓及21樓。
- 第3座、第5座、第6座、第7座、第8座、第9座及第10座均不設2樓。
- 上表內之“-”符號代表“沒有提供”。
- 上表內填上灰色“■”之部分代表“不適用”。

# FITTINGS, FINISHES AND APPLIANCES

## 裝置、裝修物料及設備

### Appliances Schedule 設備說明表

#### Tower 5 第5座

Location 位置	Appliances 設備	Brand Name 品牌名稱	7/F 7樓			8/F to 37/F 8樓至37樓			38/F to 39/F 38樓至39樓	38/F & 39/F 38樓及39樓
			A	B	C	A	B	C	A	C
			Model Number 產品型號							
Kitchen 廚房	Cooker Hood 抽油煙機	Miele 美諾	DA3190	DA3190	DA3190	DA3190	DA3190	DA3190	DA422-4	DA422-4
	Gas Cooking Hob 煤氣煮食爐	Miele 美諾	CS1018G CS1013G	CS1018G CS1013G	CS1018G CS1013G	CS1018G CS1013G	CS1018G CS1013G	CS1018G CS1013G	CS1018G CS1013G	CS1018G CS1013G
	Gas Water Heater 煤氣熱水爐	TGC	NJW160TFQL <sup>(1)</sup>	NJW160TFQL <sup>(1)</sup>	NJW220TFQL <sup>(2)</sup>	NJW160TFQL <sup>(1)</sup>	NJW160TFQL <sup>(1)</sup>	NJW220TFQL <sup>(2)</sup>	NJW220TFQL <sup>(2)</sup>	NJW220TFQL <sup>(1)</sup>
	Microwave Oven 微波爐	Miele 美諾	M8161-2	M8161-2	M8161-2	M8161-2	M8161-2	M8161-2	M8161-2	M8161-2
	Refrigerator 雪櫃	Siemens 西門子	KI38VA/ KU15R	KI38VA/ KU15R	KI38VA	KI38VA/ KU15R	KI38VA/ KU15R	KI38VA	-	-
Sub-Zero		-	-	-	-	-	-	ICBBI-42S	ICBBI-42S	

The vendor undertakes that if lifts and appliances of the specified brand name or model number are not installed in the Development, lifts or appliances of comparable quality will be installed.

賣方承諾如該發展項目中沒有安裝指明的品牌名稱或產品型號的升降機或設備，便會安裝品質相若的升降機或設備。

#### Notes:

- The residential floors start from 7/F in all towers of the Development.
  - There is no Tower 4 in the Development.
  - There are no 4/F, 13/F, 14/F, 24/F and 34/F in all towers of the Development.
  - There are no 6/F and 19/F in Tower 1 and Tower 2 and no 20/F and 21/F in Tower 6, Tower 7, Tower 9 and Tower 10.
  - There are no 2/F in Tower 3, Tower 5, Tower 6, Tower 7, Tower 8, Tower 9 and Tower 10.
  - The symbol “-” as shown in the above table denotes “Not Provided”.
  - The cells shaded in grey “■” as shown in the above table denotes “Not Applicable”.
- (1) : The gas water heater located at A/C room & served for Lavatory leading from Kitchen, Kitchen and Bathroom  
 (2) : The gas water heater located at A/C room & served for Kitchen and Bathroom  
 (3) : The gas water heater located at A/C room & served for Lavatory leading from Kitchen and Bathroom in Ensuite Bedroom  
 (4) : The gas water heater located at A/C room & served for Lavatory leading from Kitchen, Kitchen and Bathroom

#### 備註：

- 發展項目內所有座樓之住宅由7樓開始。
  - 發展項目不設第4座。
  - 發展項目內所有座樓均不設4樓、13樓、14樓、24樓及34樓。
  - 第1座及第2座均不設6樓及19樓；第6座、第7座、第9座及第10座均不設20樓及21樓。
  - 第3座、第5座、第6座、第7座、第8座、第9座及第10座均不設2樓。
  - 上表內之“-”符號代表“沒有提供”。
  - 上表內填上灰色“■”之部分代表“不適用”。
- (1) : 該款煤氣熱水爐位於冷氣機房及供應熱水給由廚房通往之洗手間、廚房和浴室  
 (2) : 該款煤氣熱水爐位於冷氣機房及供應熱水給廚房和浴室  
 (3) : 該款煤氣熱水爐位於冷氣機房及供應熱水給由廚房通往之洗手間和套房內之浴室  
 (4) : 該款煤氣熱水爐位於冷氣機房及供應熱水給由廚房通往之洗手間、廚房和浴室

# FITTINGS, FINISHES AND APPLIANCES

## 裝置、裝修物料及設備

### Appliances Schedule 設備說明表

#### Tower 5 第5座

Location 位置	Appliances 設備	Brand Name 品牌名稱	7/F 7樓			8/F to 37/F 8樓至37樓			38/F to 39/F 38樓至39樓	38/F & 39/F 38樓及39樓
			A	B	C	A	B	C	A	C
			Model Number 產品型號							
Kitchen 廚房	Washer/Dryer 洗衣/乾衣機	Miele 美諾	-	-	-	-	-	-	WT2789i	WT2789i
		Siemens 西門子	WK16D	WK16D	WK16D	WK16D	WK16D	WK16D	-	-
	Exhaust Fan 抽氣扇	Xpelair	GX 6	GX 6	GX 6	GX 6	GX 6	GX 6	GX 6	GX 6
	Induction Hob 電磁爐	Miele 美諾	CS1212	CS1212	-	CS1212	CS1212	-	CS1212	CS1212
	Steam Oven 電蒸爐	Miele 美諾	DGC5051	DGC5051	DGC5051	DGC5051	DGC5051	DGC5051	DGC5051	DGC5051
	Wine Cellar 酒櫃	Miele 美諾	KWT4154UG-1	KWT4154UG-1	KWT4154UG-1	KWT4154UG-1	KWT4154UG-1	KWT4154UG-1	KWT4154UG-1	KWT4154UG-1
	Door Bell 門鐘	Hager 海格	XC001	XC001	XC001	XC001	XC001	XC001	XC001	XC001
	Videophone 視像對講機	Bitron	-	-	-	-	-	-	AV2850/1	AV2850/1

The vendor undertakes that if lifts and appliances of the specified brand name or model number are not installed in the Development, lifts or appliances of comparable quality will be installed.  
賣方承諾如該發展項目中沒有安裝指明的品牌名稱或產品型號的升降機或設備，便會安裝品質相若的升降機或設備。

#### Notes:

- The residential floors start from 7/F in all towers of the Development.
- There is no Tower 4 in the Development.
- There are no 4/F, 13/F, 14/F, 24/F and 34/F in all towers of the Development.
- There are no 6/F and 19/F in Tower 1 and Tower 2 and no 20/F and 21/F in Tower 6, Tower 7, Tower 9 and Tower 10.
- There are no 2/F in Tower 3, Tower 5, Tower 6, Tower 7, Tower 8, Tower 9 and Tower 10.
- The symbol “-” as shown in the above table denotes “Not Provided”.
- The cells shaded in grey “■” as shown in the above table denotes “Not Applicable”.

#### 備註：

- 發展項目內所有座樓之住宅由7樓開始。
- 發展項目不設第4座。
- 發展項目內所有座樓均不設4樓、13樓、14樓、24樓及34樓。
- 第1座及第2座均不設6樓及19樓；第6座、第7座、第9座及第10座均不設20樓及21樓。
- 第3座、第5座、第6座、第7座、第8座、第9座及第10座均不設2樓。
- 上表內之“-”符號代表“沒有提供”。
- 上表內填上灰色“■”之部分代表“不適用”。

# FITTINGS, FINISHES AND APPLIANCES

## 裝置、裝修物料及設備

### Appliances Schedule 設備說明表

#### Tower 5 第5座

Location 位置	Appliances 設備	Brand Name 品牌名稱	7/F 7樓			8/F to 37/F 8樓至37樓			38/F to 39/F 38樓至39樓	38/F & 39/F 38樓及39樓
			A	B	C	A	B	C	A	C
			Model Number 產品型號							
Bathroom in Master Bedroom 主人房內之浴室	15"LCD TV 15"液晶體電視	JSA	-	-	-	-	-	-	TMBG15	TMBG15
	10"LCD TV 10"液晶體電視	JSA	TMBG10i	TMBG10i	-	TMBG10i	TMBG10i	-	-	-
	Ceiling Speaker 揚聲器	KEF	-	-	-	-	-	-	2 x Cs130.2FS	2 x Cs130.2FS
	Gas Water Heater 煤氣熱水爐	TGC	NJW220TFQL	NJW220TFQL	NJW220TFQL	NJW220TFQL	NJW220TFQL	NJW220TFQL	-	NJW220TFQL
	Exhaust Fan 抽氣扇	Ostberg 奧斯博格	RFE-140A	RFE-140A	-	RFE-140A	RFE-140A	-	REF-200B	RFE 140B
Xpelair		-	-	GX 6	-	-	GX 6	-	-	
Bathroom 浴室	Gas Water Heater 煤氣熱水爐	TGC	NJW160TFQL <sup>(1)</sup>	NJW160TFQL <sup>(1)</sup>	NJW220TFQL <sup>(2)</sup>	NJW160TFQL <sup>(1)</sup>	NJW160TFQL <sup>(1)</sup>	NJW220TFQL <sup>(2)</sup>	NJW220TFQL <sup>(2)</sup>	NJW220TFQL <sup>(1)</sup>
	Exhaust Fan 抽氣扇	Ostberg 奧斯博格	RFE-140A	RFE-140A	RFE 140A	RFE-140A	RFE-140A	RFE 140A	RFE 140A	RFE 140B

The vendor undertakes that if lifts and appliances of the specified brand name or model number are not installed in the Development, lifts or appliances of comparable quality will be installed.  
賣方承諾如該發展項目中沒有安裝指明的品牌名稱或產品型號的升降機或設備，便會安裝品質相若的升降機或設備。

#### Notes:

- The residential floors start from 7/F in all towers of the Development.
  - There is no Tower 4 in the Development.
  - There are no 4/F, 13/F, 14/F, 24/F and 34/F in all towers of the Development.
  - There are no 6/F and 19/F in Tower 1 and Tower 2 and no 20/F and 21/F in Tower 6, Tower 7, Tower 9 and Tower 10.
  - There are no 2/F in Tower 3, Tower 5, Tower 6, Tower 7, Tower 8, Tower 9 and Tower 10.
  - The symbol “-” as shown in the above table denotes “Not Provided”.
  - The cells shaded in grey “■” as shown in the above table denotes “Not Applicable”.
- (1) : The gas water heater located at A/C room & served for Lavatory leading from Kitchen, Kitchen and Bathroom  
(2) : The gas water heater located at A/C room & served for Kitchen and Bathroom  
(3) : The gas water heater located at A/C room & served for Lavatory leading from Kitchen and Bathroom in Ensuite Bedroom  
(4) : The gas water heater located at A/C room & served for Lavatory leading from Kitchen, Kitchen and Bathroom

#### 備註：

- 發展項目內所有座樓之住宅由7樓開始。
  - 發展項目不設第4座。
  - 發展項目內所有座樓均不設4樓、13樓、14樓、24樓及34樓。
  - 第1座及第2座均不設6樓及19樓；第6座、第7座、第9座及第10座均不設20樓及21樓。
  - 第3座、第5座、第6座、第7座、第8座、第9座及第10座均不設2樓。
  - 上表內之“-”符號代表“沒有提供”。
  - 上表內填上灰色“■”之部分代表“不適用”。
- (1) : 該款煤氣熱水爐位於冷氣機房及供應熱水給由廚房通往之洗手間、廚房和浴室  
(2) : 該款煤氣熱水爐位於冷氣機房及供應熱水給廚房和浴室  
(3) : 該款煤氣熱水爐位於冷氣機房及供應熱水給由廚房通往之洗手間和套房內之浴室  
(4) : 該款煤氣熱水爐位於冷氣機房及供應熱水給由廚房通往之洗手間、廚房和浴室

# FITTINGS, FINISHES AND APPLIANCES

## 裝置、裝修物料及設備

### Appliances Schedule 設備說明表

#### Tower 5 第5座

Location 位置	Appliances 設備	Brand Name 品牌名稱	7/F 7樓			8/F to 37/F 8樓至37樓			38/F to 39/F 38樓至39樓	38/F & 39/F 38樓及39樓
			A	B	C	A	B	C	A	C
			Model Number 產品型號							
Bathroom in Ensuite Bedroom 套房內之浴室	Gas Water Heater 煤氣熱水爐	TGC							NJW220TFQL <sup>(3)</sup>	NJW160TFQL
	Exhaust Fan 抽氣扇	Ostberg 奧斯博格							RFE 140A	RFE 140B
Lavatory near to Living Room 鄰近客廳之 洗手間	Gas Water Heater 煤氣熱水爐	TGC							NJW220TFQL <sup>(3)</sup>	
	Exhaust Fan 抽氣扇	Ostberg 奧斯博格							RFE-140A	
Lavatory leading from Kitchen 由廚房通往之 洗手間	Gas Water Heater 煤氣熱水爐	TGC	NJW160TFQL <sup>(1)</sup>	NJW160TFQL <sup>(1)</sup>		NJW160TFQL <sup>(1)</sup>	NJW160TFQL <sup>(1)</sup>		-	NJW220TFQL <sup>(1)</sup>
	Exhaust Fan 抽氣扇	Xpelair	GX 6	GX 6		GX 6	GX 6		-	-
		Ostberg 奧斯博格	-	-		-	-		-	RFE 140A

The vendor undertakes that if lifts and appliances of the specified brand name or model number are not installed in the Development, lifts or appliances of comparable quality will be installed.  
賣方承諾如該發展項目中沒有安裝指明的品牌名稱或產品型號的升降機或設備，便會安裝品質相若的升降機或設備。

#### Notes:

- The residential floors start from 7/F in all towers of the Development.
  - There is no Tower 4 in the Development.
  - There are no 4/F, 13/F, 14/F, 24/F and 34/F in all towers of the Development.
  - There are no 6/F and 19/F in Tower 1 and Tower 2 and no 20/F and 21/F in Tower 6, Tower 7, Tower 9 and Tower 10.
  - There are no 2/F in Tower 3, Tower 5, Tower 6, Tower 7, Tower 8, Tower 9 and Tower 10.
  - The symbol “-” as shown in the above table denotes “Not Provided”.
  - The cells shaded in grey “■” as shown in the above table denotes “Not Applicable”.
- (1): The gas water heater located at A/C room & served for Lavatory leading from Kitchen, Kitchen and Bathroom  
(2): The gas water heater located at A/C room & served for Kitchen and Bathroom  
(3): The gas water heater located at A/C room & served for Lavatory leading from Kitchen and Bathroom in Ensuite Bedroom  
(4): The gas water heater located at A/C room & served for Lavatory leading from Kitchen, Kitchen and Bathroom

#### 備註:

- 發展項目內所有座樓之住宅由7樓開始。
  - 發展項目不設第4座。
  - 發展項目內所有座樓均不設4樓、13樓、14樓、24樓及34樓。
  - 第1座及第2座均不設6樓及19樓；第6座、第7座、第9座及第10座均不設20樓及21樓。
  - 第3座、第5座、第6座、第7座、第8座、第9座及第10座均不設2樓。
  - 上表內之“-”符號代表“沒有提供”。
  - 上表內填上灰色“■”之部分代表“不適用”。
- (1): 該款煤氣熱水爐位於冷氣機房及供應熱水給由廚房通往之洗手間、廚房和浴室  
(2): 該款煤氣熱水爐位於冷氣機房及供應熱水給廚房和浴室  
(3): 該款煤氣熱水爐位於冷氣機房及供應熱水給由廚房通往之洗手間和套房內之浴室  
(4): 該款煤氣熱水爐位於冷氣機房及供應熱水給由廚房通往之洗手間、廚房和浴室



# FITTINGS, FINISHES AND APPLIANCES

## 裝置、裝修物料及設備

### Schedule of Mechanical and Electrical Provisions 機電裝置數量說明表

#### Tower 5 第5座

Location 位置	Exposed Type 外露型	Non-Exposed Type 非外露型	7/F 7樓			8/F to 37/F 8樓至37樓			38/F 38樓		39/F 39樓		
			A	B	C	A	B	C	A	C	A	C	
Living Room, Dining Room & Corridor 客廳、飯廳及 走廊	TV/ FM Outlet 電視/電台天線插座		3	3	2	3	3	2	2	2	2	-	
	Telephone Outlet 電話插座		2	2	2	2	2	2	2	2	2	-	
	13A Twin Socket Outlet 13A雙位電插座		5	5	2	6	6	5	4	4	4	-	
	13A Single Socket Outlet 13A單位電插座		4	4	5	3	3	3	6	2	6	1	
	Lighting Switch 燈掣		7	7	7	6	6	7	10	4	9	2	
		Door Bell 門鐘		1	1	1	1	1	1	1	-	1	1
		Door Phone Handset 對講機		1	1	1	1	1	1	-	-	-	-
		20A Double Pole Switch with Pilot Lamp 20A 雙極開關掣		2	2	2	2	2	2	2	1	2	-
	Fused Spur Unit/Connection Unit 接線座		1	1	1	1	1	1	1	-	1	1	
Master Bedroom 主人房	TV/ FM Outlet 電視/電台天線插座		2	2	1	2	2	1	2		2	2	
	Telephone Outlet 電話插座		2	2	1	2	2	1	2		2	2	
	13A Twin Socket Outlet 13A雙位電插座		3	3	3	3	3	3	6		6	4	
	13A Single Socket Outlet 13A單位電插座		2	1	1	2	2	1	-		-	3	
	Lighting Switch 燈掣		4	4	2	4	4	2	3		3	3	
	20A Double Pole Switch with Pilot Lamp 20A 雙極開關掣		1	1	1	1	1	1	2		2	2	

#### Notes:

- The residential floors start from 7/F in all towers of the Development.
- There is no Tower 4 in the Development.
- There are no 4/F, 13/F, 14/F, 24/F and 34/F in all towers of the Development.
- There are no 6/F and 19/F in Tower 1 and Tower 2 and no 20/F and 21/F in Tower 6, Tower 7, Tower 9 and Tower 10.
- There are no 2/F in Tower 3, Tower 5, Tower 6, Tower 7, Tower 8, Tower 9 and Tower 10.
- The symbol “-” as shown in the above table denotes “Not Provided”.
- The cells shaded in grey “■” as shown in the above table denotes “Not Applicable”.

#### 備註：

- 發展項目內所有座樓之住宅由7樓開始。
- 發展項目不設第4座。
- 發展項目內所有座樓均不設4樓、13樓、14樓、24樓及34樓。
- 第1座及第2座均不設6樓及19樓；第6座、第7座、第9座及第10座均不設20樓及21樓。
- 第3座、第5座、第6座、第7座、第8座、第9座及第10座均不設2樓。
- 上表內之“-”符號代表“沒有提供”。
- 上表內填上灰色“■”之部分代表“不適用”。

# FITTINGS, FINISHES AND APPLIANCES

## 裝置、裝修物料及設備

### Schedule of Mechanical and Electrical Provisions 機電裝置數量說明表

#### Tower 5 第5座

Location 位置	Exposed Type 外露型	Non-Exposed Type 非外露型	7/F 7樓			8/F to 37/F 8樓至37樓			38/F 38樓		39/F 39樓	
			A	B	C	A	B	C	A	C	A	C
Bedroom 1 睡房1	TV/ FM Outlet 電視/電台天線插座				1			1	2		2	
	Telephone Outlet 電話插座				1			1	2		2	
	13A Twin Socket Outlet 13A雙位電插座				1			1	2		2	
	13A Single Socket Outlet 13A單位電插座				1			1	-		-	
	Lighting Switch 燈掣				1			1	2		2	
Bedroom 2 睡房2	TV/ FM Outlet 電視/電台天線插座				1			1				
	Telephone Outlet 電話插座				1			1				
	13A Twin Socket Outlet 13A雙位電插座				2			2				
	13A Single Socket Outlet 13A單位電插座				-			-				
	Lighting Switch 燈掣				1			1				

#### Notes:

- The residential floors start from 7/F in all towers of the Development.
- There is no Tower 4 in the Development.
- There are no 4/F, 13/F, 14/F, 24/F and 34/F in all towers of the Development.
- There are no 6/F and 19/F in Tower 1 and Tower 2 and no 20/F and 21/F in Tower 6, Tower 7, Tower 9 and Tower 10.
- There are no 2/F in Tower 3, Tower 5, Tower 6, Tower 7, Tower 8, Tower 9 and Tower 10.
- The symbol “-” as shown in the above table denotes “Not Provided”.
- The cells shaded in grey “■” as shown in the above table denotes “Not Applicable”.

#### 備註：

- 發展項目內所有座樓之住宅由7樓開始。
- 發展項目不設第4座。
- 發展項目內所有座樓均不設4樓、13樓、14樓、24樓及34樓。
- 第1座及第2座均不設6樓及19樓；第6座、第7座、第9座及第10座均不設20樓及21樓。
- 第3座、第5座、第6座、第7座、第8座、第9座及第10座均不設2樓。
- 上表內之“-”符號代表“沒有提供”。
- 上表內填上灰色“■”之部分代表“不適用”。

# FITTINGS, FINISHES AND APPLIANCES

## 裝置、裝修物料及設備

### Schedule of Mechanical and Electrical Provisions 機電裝置數量說明表

#### Tower 5 第5座

Location 位置	Exposed Type 外露型	Non-Exposed Type 非外露型	7/F 7樓			8/F to 37/F 8樓至37樓			38/F 38樓		39/F 39樓	
			A	B	C	A	B	C	A	C	A	C
Ensuite Bedroom 套房	TV/ FM Outlet 電視/電台天線插座								2	1	2	2
	Telephone Outlet 電話插座								2	1	2	1
	13A Twin Socket Outlet 13A雙位電插座								4	2	4	2
	13A Single Socket Outlet 13A單位電插座								2	2	2	1
	Lighting Switch 燈掣								3	1	3	2
	20A Double Pole Switch with Pilot Lamp 20A 雙極開關掣								1	-	1	1
Store 士多房	TV/ FM Outlet 電視/電台天線插座		1	1	1	1	1	1	1	1	1	
	Telephone Outlet 電話插座		-	-	-	-	-	-	1	1	1	
	13A Twin Socket Outlet 13A雙位電插座		1	1	1	1	1	1	1	1	1	
	Lighting Switch 燈掣		1	1	1	1	1	1	1	1	1	
	20A Double Pole Switch with Pilot Lamp 20A 雙極開關掣		2	2	-	1	1	-	1	2	1	
Store under staircase 樓梯下的 士多房	Lighting Switch 燈掣									1		

#### Notes:

- The residential floors start from 7/F in all towers of the Development.
- There is no Tower 4 in the Development.
- There are no 4/F, 13/F, 14/F, 24/F and 34/F in all towers of the Development.
- There are no 6/F and 19/F in Tower 1 and Tower 2 and no 20/F and 21/F in Tower 6, Tower 7, Tower 9 and Tower 10.
- There are no 2/F in Tower 3, Tower 5, Tower 6, Tower 7, Tower 8, Tower 9 and Tower 10.
- The symbol “-” as shown in the above table denotes “Not Provided”.
- The cells shaded in grey “■” as shown in the above table denotes “Not Applicable”.

#### 備註：

- 發展項目內所有座樓之住宅由7樓開始。
- 發展項目不設第4座。
- 發展項目內所有座樓均不設4樓、13樓、14樓、24樓及34樓。
- 第1座及第2座均不設6樓及19樓；第6座、第7座、第9座及第10座均不設20樓及21樓。
- 第3座、第5座、第6座、第7座、第8座、第9座及第10座均不設2樓。
- 上表內之“-”符號代表“沒有提供”。
- 上表內填上灰色“■”之部分代表“不適用”。

# FITTINGS, FINISHES AND APPLIANCES

## 裝置、裝修物料及設備

### Schedule of Mechanical and Electrical Provisions 機電裝置數量說明表

#### Tower 5 第5座

Location 位置	Exposed Type 外露型	Non-Exposed Type 非外露型	7/F 7樓			8/F to 37/F 8樓至37樓			38/F 38樓		39/F 39樓	
			A	B	C	A	B	C	A	C	A	C
Bathroom in Master Bedroom 主人房內之浴室	TV / FM Outlet 電視/電台天線插座		1	1	1	1	1	1	1		1	1
	13A Single Socket Outlet 13A單位電插座		2	2	2	2	2	2	3		3	3
	Fused Spur Unit/Connection Unit接線座		1	1	1	1	1	1	1		1	1
Bathroom in Ensuite Bedroom 套房內之浴室	13A Single Socket Outlet 13A單位電插座								1		1	1
	Fused Spur Unit/Connection Unit接線座								1		1	1
Bathroom 浴室	13A Single Socket Outlet 13A單位電插座		1	1	1	1	1	1	1	1	1	
	Fused Spur Unit/Connection Unit接線座		1	1	1	1	1	1	1	1	1	
Lavatory near to Living Room 鄰近客廳之 洗手間	13A Single Socket Outlet 13A單位電插座								1		1	
	Fused Spur Unit/Connection Unit 接線座								1		1	
Lavatory leading from Kitchen 由廚房通往之 洗手間		Fused Spur Unit/Connection Unit 接線座	1	1	-	1	1	-	1	1	1	

#### Notes:

- The residential floors start from 7/F in all towers of the Development.
- There is no Tower 4 in the Development.
- There are no 4/F, 13/F, 14/F, 24/F and 34/F in all towers of the Development.
- There are no 6/F and 19/F in Tower 1 and Tower 2 and no 20/F and 21/F in Tower 6, Tower 7, Tower 9 and Tower 10.
- There are no 2/F in Tower 3, Tower 5, Tower 6, Tower 7, Tower 8, Tower 9 and Tower 10.
- The symbol “-” as shown in the above table denotes “Not Provided”.
- The cells shaded in grey “■” as shown in the above table denotes “Not Applicable”.

#### 備註：

- 發展項目內所有座樓之住宅由7樓開始。
- 發展項目不設第4座。
- 發展項目內所有座樓均不設4樓、13樓、14樓、24樓及34樓。
- 第1座及第2座均不設6樓及19樓；第6座、第7座、第9座及第10座均不設20樓及21樓。
- 第3座、第5座、第6座、第7座、第8座、第9座及第10座均不設2樓。
- 上表內之“-”符號代表“沒有提供”。
- 上表內填上灰色“■”之部分代表“不適用”。

# FITTINGS, FINISHES AND APPLIANCES

## 裝置、裝修物料及設備

### Schedule of Mechanical and Electrical Provisions 機電裝置數量說明表

#### Tower 5 第5座

Location 位置	Exposed Type 外露型	Non-Exposed Type 非外露型	7/F 7樓			8/F to 37/F 8樓至37樓			38/F 38樓		39/F 39樓	
			A	B	C	A	B	C	A	C	A	C
Kitchen 廚房	13A Twin Socket Outlet 13A雙位電插座		2	2	2	2	2	2	3	2	3	
	13A Single Socket Outlet 13A單位電插座		-	-	1	-	-	1	-	-	-	
		13A Single Socket Outlet 13A單位電插座	7	7	6	7	7	6	7	7	7	
	Lighting Switch 燈掣		-	-	-	-	-	-	1	1	1	
		Door Bell 門鐘	1	1	1	1	1	1	1	1	1	
	Door Phone Handset 對講機		-	-	-	-	-	-	1	1	1	
		20A Double Pole Switch with Pilot Lamp 20A 雙極開關掣	1	1	1	1	1	1	2	2	2	
		Fused Spur Unit/Connection Unit 接線座	3	3	2	3	3	2	3	3	3	
		Drain Point For Washing Machine 去水位供洗衣機	1	1	1	1	1	1	1	1	1	
		Water Point For Washing Machine 來水位供洗衣機	1	1	1	1	1	1	1	1	1	
Stairhood 梯屋	Lighting Switch 燈掣									-	2	2
Flat Roof 平台	13A Weather Proof Single / Twin Socket Outlet 13A 防水單位/雙位電插座		2	2	1	_(#)	_(#)		1			1
Roof 天台	13A Weather Proof Single / Twin Socket Outlet 13A 防水單位/雙位電插座										1	1

#### Notes:

- The residential floors start from 7/F in all towers of the Development.
- There is no Tower 4 in the Development.
- There are no 4/F, 13/F, 14/F, 24/F and 34/F in all towers of the Development.
- There are no 6/F and 19/F in Tower 1 and Tower 2 and no 20/F and 21/F in Tower 6, Tower 7, Tower 9 and Tower 10.
- There are no 2/F in Tower 3, Tower 5, Tower 6, Tower 7, Tower 8, Tower 9 and Tower 10.
- The symbol “-” as shown in the above table denotes “Not Provided”.
- The cells shaded in grey “■” as shown in the above table denotes “Not Applicable”.
- The provision mark with “#” only apply to Flat A of 10/F and Flat B of 11/F. There is no Flat Roof for other floors.

#### 備註:

- 發展項目內所有座樓之住宅由7樓開始。
- 發展項目不設第4座。
- 發展項目內所有座樓均不設4樓、13樓、14樓、24樓及34樓。
- 第1座及第2座均不設6樓及19樓；第6座、第7座、第9座及第10座均不設20樓及21樓。
- 第3座、第5座、第6座、第7座、第8座、第9座及第10座均不設2樓。
- 上表內之“-”符號代表“沒有提供”。
- 上表內填上灰色“■”之部分代表“不適用”。
- 註有“#”的數量只適用於10樓A單位及11樓B單位，其餘樓層並沒有平台。

# FITTINGS, FINISHES AND APPLIANCES

## 裝置、裝修物料及設備

### Appliances Schedule 設備說明表

#### Tower 6 第6座

Location 位置	Appliances 設備	Brand Name 品牌名稱	7/F 7樓			8/F to 19/F & 26/F to 37/F 8樓至19樓及26樓至37樓		
			A	B	C	A	B	C
			Model Number 產品型號					
Living Room, Dining Room & Corridor 客廳、飯廳 及走廊	Split Type Air-Conditioner 分體式冷氣機	Panasonic	Indoor Unit 室內機			Indoor Unit 室內機		
			CS-E18JD4H(2NOS.)/ CS-E10HD3EA	CS-E18JD4H(2NOS.)/ CS-E10HD3EA	CS-E23JD4H	CS-E18JD4H(2NOS.)/ CS-E10HD3EA	CS-E18JD4H(2NOS.)/ CS-E10HD3EA	CS-E23JD4H
			Outdoor Unit 室外機			Outdoor Unit 室外機		
			CU-E18JBH(2NOS.)/ CU-2E18CBPGW (Shared Outdoor Unit) (共用室外組件)	CU-E18JBH(2NOS.)/ CU-2E18CBPGW (Shared Outdoor Unit) (共用室外組件)	CU-E23JBH	CU-E18JBH(2NOS.)/ CU-2E18CBPGW (Shared Outdoor Unit) (共用室外組件)	CU-E18JBH(2NOS.)/ CU-2E18CBPGW (Shared Outdoor Unit) (共用室外組件)	CU-E23JBH
Master Bedroom 主人房	Split Type Air-Conditioner 分體式冷氣機	Panasonic	Indoor Unit 室內機			Indoor Unit 室內機		
			CS-E18JD4H/ CS-E10HD3EA	CS-E18JD4H/ CS-E10HD3EA	CS-E12JD4H	CS-E18JD4H/ CS-E10HD3EA	CS-E18JD4H/ CS-E10HD3EA	CS-E12JD4H
			Outdoor Unit 室外機			Outdoor Unit 室外機		
			CU-E18JBH/ CU-2E18CBPGW (Shared Outdoor Unit) (共用室外組件)	CU-E18JBH/ CU-2E18CBPGW (Shared Outdoor Unit) (共用室外組件)	CU-E12JBH	CU-E18JBH/ CU-2E18CBPGW (Shared Outdoor Unit) (共用室外組件)	CU-E18JBH/ CU-2E18CBPGW (Shared Outdoor Unit) (共用室外組件)	CU-E12JBH

The vendor undertakes that if lifts and appliances of the specified brand name or model number are not installed in the Development, lifts or appliances of comparable quality will be installed.  
賣方承諾如該發展項目中沒有安裝指明的品牌名稱或產品型號的升降機或設備，便會安裝品質相若的升降機或設備。

#### Notes:

- The residential floors start from 7/F in all towers of the Development.
- There is no Tower 4 in the Development.
- There are no 4/F, 13/F, 14/F, 24/F and 34/F in all towers of the Development.
- There are no 6/F and 19/F in Tower 1 and Tower 2 and no 20/F and 21/F in Tower 6, Tower 7, Tower 9 and Tower 10.
- There are no 2/F in Tower 3, Tower 5, Tower 6, Tower 7, Tower 8, Tower 9 and Tower 10.
- The symbol “-” as shown in the above table denotes “Not Provided”.
- The cells shaded in grey “■” as shown in the above table denotes “Not Applicable”.

#### 備註：

- 發展項目內所有座樓之住宅由7樓開始。
- 發展項目不設第4座。
- 發展項目內所有座樓均不設4樓、13樓、14樓、24樓及34樓。
- 第1座及第2座均不設6樓及19樓；第6座、第7座、第9座及第10座均不設20樓及21樓。
- 第3座、第5座、第6座、第7座、第8座、第9座及第10座均不設2樓。
- 上表內之“-”符號代表“沒有提供”。
- 上表內填上灰色“■”之部分代表“不適用”。

# FITTINGS, FINISHES AND APPLIANCES

## 裝置、裝修物料及設備

### Appliances Schedule 設備說明表

#### Tower 6 第6座

Location 位置	Appliances 設備	Brand Name 品牌名稱	22/F to 25/F 22樓至25樓		38/F to 39/F 38樓至39樓	38/F & 39/F 38樓及39樓
			A	C	A	C
			Model Number 產品型號			
Living Room, Dining Room & Corridor 客廳、飯廳 及走廊	Split Type Air-Conditioner 分體式冷氣機	Panasonic	Indoor Unit 室內機		Indoor Unit 室內機	Indoor Unit 室內機
			CS-E18JD4H(2NOS.)/ CS-E10HD3EA	CS-E23JD4H	CS-E18JD4H(3NOS)	CS-E18JD4H(2NOS)
			Outdoor Unit 室外機		Outdoor Unit 室外機	Outdoor Unit 室外機
			CU-E18JBH(2NOS.)/ CU-2E18CBPGW (Shared Outdoor Unit) (共用室外組件)	CU-E23JBH	CU-E18JBH(3NOS.)	CU-E18JBH(2NOS.)
Master Bedroom 主人房	Split Type Air-Conditioner 分體式冷氣機	Panasonic	Indoor Unit 室內機		Indoor Unit 室內機	Indoor Unit 室內機
			CS-E18JD4H/ CS-E10HD3EA	CS-E12JD4H	CS-E23JD4H	CS-E18JD4H(2NOS)
			Outdoor Unit 室外機		Outdoor Unit 室外機	Outdoor Unit 室外機
			CU-E18JBH/ CU-2E18CBPGW (Shared Outdoor Unit) (共用室外組件)	CU-E12JBH	CU-E23JBH	CU-E18JBH(2NOS)

The vendor undertakes that if lifts and appliances of the specified brand name or model number are not installed in the Development, lifts or appliances of comparable quality will be installed.  
賣方承諾如該發展項目中沒有安裝指明的品牌名稱或產品型號的升降機或設備，便會安裝品質相若的升降機或設備。

#### Notes:

- The residential floors start from 7/F in all towers of the Development.
- There is no Tower 4 in the Development.
- There are no 4/F, 13/F, 14/F, 24/F and 34/F in all towers of the Development.
- There are no 6/F and 19/F in Tower 1 and Tower 2 and no 20/F and 21/F in Tower 6, Tower 7, Tower 9 and Tower 10.
- There are no 2/F in Tower 3, Tower 5, Tower 6, Tower 7, Tower 8, Tower 9 and Tower 10.
- The symbol “-” as shown in the above table denotes “Not Provided”.
- The cells shaded in grey “■” as shown in the above table denotes “Not Applicable”.

#### 備註：

- 發展項目內所有座樓之住宅由7樓開始。
- 發展項目不設第4座。
- 發展項目內所有座樓均不設4樓、13樓、14樓、24樓及34樓。
- 第1座及第2座均不設6樓及19樓；第6座、第7座、第9座及第10座均不設20樓及21樓。
- 第3座、第5座、第6座、第7座、第8座、第9座及第10座均不設2樓。
- 上表內之“-”符號代表“沒有提供”。
- 上表內填上灰色“■”之部分代表“不適用”。

# FITTINGS, FINISHES AND APPLIANCES

## 裝置、裝修物料及設備

### Appliances Schedule 設備說明表

#### Tower 6 第6座

Location 位置	Appliances 設備	Brand Name 品牌名稱	7/F 7樓			8/F to 19/F & 26/F to 37/F 8樓至19樓及26樓至37樓		
			A	B	C	A	B	C
			Model Number 產品型號					
Bedroom 1 睡房1	Split Type Air-Conditioner 分體式冷氣機	Panasonic	Indoor Unit 室內機			Indoor Unit 室內機		
					CS-E9JKEW			CS-E9JKEW
			Outdoor Unit 室外機			Outdoor Unit 室外機		
					CU-2E18CBPGW (Shared Outdoor Unit) (共用室外組件)			CU-2E18CBPGW (Shared Outdoor Unit) (共用室外組件)
Bedroom 2 睡房2	Split Type Air-Conditioner 分體式冷氣機	Panasonic	Indoor Unit 室內機			Indoor Unit 室內機		
					CS-E9JKEW			CS-E9JKEW
			Outdoor Unit 室外機			Outdoor Unit 室外機		
					CU-2E18CBPGW (Shared Outdoor Unit) (共用室外組件)			CU-2E18CBPGW (Shared Outdoor Unit) (共用室外組件)

The vendor undertakes that if lifts and appliances of the specified brand name or model number are not installed in the Development, lifts or appliances of comparable quality will be installed.  
賣方承諾如該發展項目中沒有安裝指明的品牌名稱或產品型號的升降機或設備，便會安裝品質相若的升降機或設備。

#### Notes:

- The residential floors start from 7/F in all towers of the Development.
- There is no Tower 4 in the Development.
- There are no 4/F, 13/F, 14/F, 24/F and 34/F in all towers of the Development.
- There are no 6/F and 19/F in Tower 1 and Tower 2 and no 20/F and 21/F in Tower 6, Tower 7, Tower 9 and Tower 10.
- There are no 2/F in Tower 3, Tower 5, Tower 6, Tower 7, Tower 8, Tower 9 and Tower 10.
- The symbol “-” as shown in the above table denotes “Not Provided”.
- The cells shaded in grey “■” as shown in the above table denotes “Not Applicable”.

#### 備註：

- 發展項目內所有座樓之住宅由7樓開始。
- 發展項目不設第4座。
- 發展項目內所有座樓均不設4樓、13樓、14樓、24樓及34樓。
- 第1座及第2座均不設6樓及19樓；第6座、第7座、第9座及第10座均不設20樓及21樓。
- 第3座、第5座、第6座、第7座、第8座、第9座及第10座均不設2樓。
- 上表內之“-”符號代表“沒有提供”。
- 上表內填上灰色“■”之部分代表“不適用”。



# FITTINGS, FINISHES AND APPLIANCES

## 裝置、裝修物料及設備

### Appliances Schedule 設備說明表

#### Tower 6 第6座

Location 位置	Appliances 設備	Brand Name 品牌名稱	22/F to 25/F 22樓至25樓		38/F to 39/F 38樓至39樓	38/F & 39/F 38樓及39樓
			A	C	A	C
			Model Number 產品型號			
Bedroom 1 睡房1	Split Type Air-Conditioner 分體式冷氣機	Panasonic	Indoor Unit 室內機		Indoor Unit 室內機	Indoor Unit 室內機
				CS-E9JKEW	CS-E12JD4H/ CS-E18JD4H	CS-E18JD4H
			Outdoor Unit 室外機		Outdoor Unit 室外機	Outdoor Unit 室外機
				CU-2E18CBPGW (Shared Outdoor Unit) (共用室外組件)	CU-E12JBH/ CU-E18JBH	CU-E18JBH
Bedroom 2 睡房2	Split Type Air-Conditioner 分體式冷氣機	Panasonic	Indoor Unit 室內機		Indoor Unit 室內機	Indoor Unit 室內機
				CS-E9JKEW		
			Outdoor Unit 室外機		Outdoor Unit 室外機	Outdoor Unit 室外機
				CU-2E18CBPGW (Shared Outdoor Unit) (共用室外組件)		

The vendor undertakes that if lifts and appliances of the specified brand name or model number are not installed in the Development, lifts or appliances of comparable quality will be installed.  
賣方承諾如該發展項目中沒有安裝指明的品牌名稱或產品型號的升降機或設備，便會安裝品質相若的升降機或設備。

#### Notes:

- The residential floors start from 7/F in all towers of the Development.
- There is no Tower 4 in the Development.
- There are no 4/F, 13/F, 14/F, 24/F and 34/F in all towers of the Development.
- There are no 6/F and 19/F in Tower 1 and Tower 2 and no 20/F and 21/F in Tower 6, Tower 7, Tower 9 and Tower 10.
- There are no 2/F in Tower 3, Tower 5, Tower 6, Tower 7, Tower 8, Tower 9 and Tower 10.
- The symbol “-” as shown in the above table denotes “Not Provided”.
- The cells shaded in grey “■” as shown in the above table denotes “Not Applicable”.

#### 備註：

- 發展項目內所有座樓之住宅由7樓開始。
- 發展項目不設第4座。
- 發展項目內所有座樓均不設4樓、13樓、14樓、24樓及34樓。
- 第1座及第2座均不設6樓及19樓；第6座、第7座、第9座及第10座均不設20樓及21樓。
- 第3座、第5座、第6座、第7座、第8座、第9座及第10座均不設2樓。
- 上表內之“-”符號代表“沒有提供”。
- 上表內填上灰色“■”之部分代表“不適用”。

# FITTINGS, FINISHES AND APPLIANCES

## 裝置、裝修物料及設備

### Appliances Schedule 設備說明表

#### Tower 6 第6座

Location 位置	Appliances 設備	Brand Name 品牌名稱	7/F 7樓			8/F to 19/F & 26/F to 37/F 8樓至19樓及26樓至37樓		
			A	B	C	A	B	C
			Model Number 產品型號					
Ensuite Bedroom 套房	Split Type Air-Conditioner 分體式冷氣機	Panasonic	Indoor Unit 室內機			Indoor Unit 室內機		
			Outdoor Unit 室外機			Outdoor Unit 室外機		
Kitchen 廚房	Split Type Air-Conditioner 分體式冷氣機	Panasonic	Indoor Unit 室內機			Indoor Unit 室內機		
			CS-E15HD3EA	CS-E15HD3EA	-	CS-E15HD3EA	CS-E15HD3EA	-
			Outdoor Unit 室外機			Outdoor Unit 室外機		
			CU-4E23JBE (Shared Outdoor Unit) (共用室外組件)	CU-4E23JBE (Shared Outdoor Unit) (共用室外組件)	-	CU-4E23JBE (Shared Outdoor Unit) (共用室外組件)	CU-4E23JBE (Shared Outdoor Unit) (共用室外組件)	-

The vendor undertakes that if lifts and appliances of the specified brand name or model number are not installed in the Development, lifts or appliances of comparable quality will be installed.  
賣方承諾如該發展項目中沒有安裝指明的品牌名稱或產品型號的升降機或設備，便會安裝品質相若的升降機或設備。

#### Notes:

- The residential floors start from 7/F in all towers of the Development.
- There is no Tower 4 in the Development.
- There are no 4/F, 13/F, 14/F, 24/F and 34/F in all towers of the Development.
- There are no 6/F and 19/F in Tower 1 and Tower 2 and no 20/F and 21/F in Tower 6, Tower 7, Tower 9 and Tower 10.
- There are no 2/F in Tower 3, Tower 5, Tower 6, Tower 7, Tower 8, Tower 9 and Tower 10.
- The symbol “-” as shown in the above table denotes “Not Provided”.
- The cells shaded in grey “■” as shown in the above table denotes “Not Applicable”.

#### 備註：

- 發展項目內所有座樓之住宅由7樓開始。
- 發展項目不設第4座。
- 發展項目內所有座樓均不設4樓、13樓、14樓、24樓及34樓。
- 第1座及第2座均不設6樓及19樓；第6座、第7座、第9座及第10座均不設20樓及21樓。
- 第3座、第5座、第6座、第7座、第8座、第9座及第10座均不設2樓。
- 上表內之“-”符號代表“沒有提供”。
- 上表內填上灰色“■”之部分代表“不適用”。

# FITTINGS, FINISHES AND APPLIANCES

## 裝置、裝修物料及設備

### Appliances Schedule 設備說明表

#### Tower 6 第6座

Location 位置	Appliances 設備	Brand Name 品牌名稱	22/F to 25/F 22樓至25樓		38/F to 39/F 38樓至39樓	38/F & 39/F 38樓及39樓
			A	C	A	C
			Model Number 產品型號			
Ensuite Bedroom 套房	Split Type Air-Conditioner 分體式冷氣機	Panasonic	Indoor Unit 室內機		Indoor Unit 室內機	Indoor Unit 室內機
					CS-E18JD4H	CS-E18JD4H
			Outdoor Unit 室外機		Outdoor Unit 室外機	Outdoor Unit 室外機
					CU-E18JBH	CU-E18JBH
Kitchen 廚房	Split Type Air-Conditioner 分體式冷氣機	Panasonic	Indoor Unit 室內機		Indoor Unit 室內機	Indoor Unit 室內機
			CS-E15HD3EA	-	CS-E15HD3EA	CS-E15HD3EA
			Outdoor Unit 室外機		Outdoor Unit 室外機	Outdoor Unit 室外機
			CU-4E23JBE (Shared Outdoor Unit) (共用室外組件)	-	CU-4E23JBE (Shared Outdoor Unit) (共用室外組件) (39/F only) (只供39樓)	CU-4E23JBE (Shared Outdoor Unit) (共用室外組件)

The vendor undertakes that if lifts and appliances of the specified brand name or model number are not installed in the Development, lifts or appliances of comparable quality will be installed.  
賣方承諾如該發展項目中沒有安裝指明的品牌名稱或產品型號的升降機或設備，便會安裝品質相若的升降機或設備。

#### Notes:

- The residential floors start from 7/F in all towers of the Development.
- There is no Tower 4 in the Development.
- There are no 4/F, 13/F, 14/F, 24/F and 34/F in all towers of the Development.
- There are no 6/F and 19/F in Tower 1 and Tower 2 and no 20/F and 21/F in Tower 6, Tower 7, Tower 9 and Tower 10.
- There are no 2/F in Tower 3, Tower 5, Tower 6, Tower 7, Tower 8, Tower 9 and Tower 10.
- The symbol “-” as shown in the above table denotes “Not Provided”.
- The cells shaded in grey “■” as shown in the above table denotes “Not Applicable”.

#### 備註：

- 發展項目內所有座樓之住宅由7樓開始。
- 發展項目不設第4座。
- 發展項目內所有座樓均不設4樓、13樓、14樓、24樓及34樓。
- 第1座及第2座均不設6樓及19樓；第6座、第7座、第9座及第10座均不設20樓及21樓。
- 第3座、第5座、第6座、第7座、第8座、第9座及第10座均不設2樓。
- 上表內之“-”符號代表“沒有提供”。
- 上表內填上灰色“■”之部分代表“不適用”。

# FITTINGS, FINISHES AND APPLIANCES

## 裝置、裝修物料及設備

### Appliances Schedule 設備說明表

#### Tower 6 第6座

Location 位置	Appliances 設備	Brand Name 品牌名稱	7/F 7樓			8/F to 19/F & 26/F to 37/F 8樓至19樓及26樓至37樓		
			A	B	C	A	B	C
			Model Number 產品型號					
Store 士多房	Split Type Air-Conditioner 分體式冷氣機	Panasonic	Indoor Unit 室內機			Indoor Unit 室內機		
			CS-E9JKEW	CS-E9JKEW	CS-RE9JKA	CS-E9JKEW	CS-E9JKEW	CS-RE9JKA
			Outdoor Unit 室外機			Outdoor Unit 室外機		
			CU-4E23JBE (Shared Outdoor Unit) (共用室外組件)	CU-4E23JBE (Shared Outdoor Unit) (共用室外組件)	CU-RE9JKA	CU-4E23JBE (Shared Outdoor Unit) (共用室外組件)	CU-4E23JBE (Shared Outdoor Unit) (共用室外組件)	CU-RE9JKA
Living Room, Dining Room & Corridor 客廳、飯廳及 走廊	Videophone 視像對講機	Bitron	AV2850/1	AV2850/1	AV2850/1	AV2850/1	AV2850/1	AV2850/1
	Door Bell 門鐘	Hager 海格	XC001	XC001	XC001	XC001	XC001	XC001

The vendor undertakes that if lifts and appliances of the specified brand name or model number are not installed in the Development, lifts or appliances of comparable quality will be installed.  
賣方承諾如該發展項目中沒有安裝指明的品牌名稱或產品型號的升降機或設備，便會安裝品質相若的升降機或設備。

#### Notes:

- The residential floors start from 7/F in all towers of the Development.
- There is no Tower 4 in the Development.
- There are no 4/F, 13/F, 14/F, 24/F and 34/F in all towers of the Development.
- There are no 6/F and 19/F in Tower 1 and Tower 2 and no 20/F and 21/F in Tower 6, Tower 7, Tower 9 and Tower 10.
- There are no 2/F in Tower 3, Tower 5, Tower 6, Tower 7, Tower 8, Tower 9 and Tower 10.
- The symbol “-” as shown in the above table denotes “Not Provided”.
- The cells shaded in grey “■” as shown in the above table denotes “Not Applicable”.

#### 備註：

- 發展項目內所有座樓之住宅由7樓開始。
- 發展項目不設第4座。
- 發展項目內所有座樓均不設4樓、13樓、14樓、24樓及34樓。
- 第1座及第2座均不設6樓及19樓；第6座、第7座、第9座及第10座均不設20樓及21樓。
- 第3座、第5座、第6座、第7座、第8座、第9座及第10座均不設2樓。
- 上表內之“-”符號代表“沒有提供”。
- 上表內填上灰色“■”之部分代表“不適用”。

# FITTINGS, FINISHES AND APPLIANCES

## 裝置、裝修物料及設備

### Appliances Schedule 設備說明表

#### Tower 6 第6座

Location 位置	Appliances 設備	Brand Name 品牌名稱	22/F to 25/F 22樓至25樓		38/F to 39/F 38樓至39樓	38/F & 39/F 38樓及39樓
			A	C	A	C
			Model Number 產品型號			
Store 士多房	Split Type Air-Conditioner 分體式冷氣機	Panasonic	Indoor Unit 室內機		Indoor Unit 室內機	Indoor Unit 室內機
			CS-E9JKEW	CS-RE9JKA	CS-E9JKEW	CS-E9JKEW
			Outdoor Unit 室外機		Outdoor Unit 室外機	Outdoor Unit 室外機
			CU-4E23JBE (Shared Outdoor Unit) (共用室外組件)	CU-RE9JKA	CU-4E23JBE (Shared Outdoor Unit) (共用室外組件) (39/F only) (只供39樓)	CU-4E23JBE (Shared Outdoor Unit) (共用室外組件)
Living Room, Dining Room & Corridor 客廳、飯廳及 走廊	Videophone 視像對講機	Bitron	AV2850/1	AV2850/1	-	-
	Door Bell 門鐘	Hager 海格	XC001	XC001	XC001	-

The vendor undertakes that if lifts and appliances of the specified brand name or model number are not installed in the Development, lifts or appliances of comparable quality will be installed.  
賣方承諾如該發展項目中沒有安裝指明的品牌名稱或產品型號的升降機或設備，便會安裝品質相若的升降機或設備。

#### Notes:

- The residential floors start from 7/F in all towers of the Development.
- There is no Tower 4 in the Development.
- There are no 4/F, 13/F, 14/F, 24/F and 34/F in all towers of the Development.
- There are no 6/F and 19/F in Tower 1 and Tower 2 and no 20/F and 21/F in Tower 6, Tower 7, Tower 9 and Tower 10.
- There are no 2/F in Tower 3, Tower 5, Tower 6, Tower 7, Tower 8, Tower 9 and Tower 10.
- The symbol “-” as shown in the above table denotes “Not Provided”.
- The cells shaded in grey “■” as shown in the above table denotes “Not Applicable”.

#### 備註：

- 發展項目內所有座樓之住宅由7樓開始。
- 發展項目不設第4座。
- 發展項目內所有座樓均不設4樓、13樓、14樓、24樓及34樓。
- 第1座及第2座均不設6樓及19樓；第6座、第7座、第9座及第10座均不設20樓及21樓。
- 第3座、第5座、第6座、第7座、第8座、第9座及第10座均不設2樓。
- 上表內之“-”符號代表“沒有提供”。
- 上表內填上灰色“■”之部分代表“不適用”。

# FITTINGS, FINISHES AND APPLIANCES

## 裝置、裝修物料及設備

### Appliances Schedule 設備說明表

#### Tower 6 第6座

Location 位置	Appliances 設備	Brand Name 品牌名稱	7/F 7樓			8/F to 19/F & 26/F to 37/F 8樓至19樓及26樓至37樓		
			A	B	C	A	B	C
			Model Number 產品型號					
Kitchen 廚房	Cooker Hood 抽油煙機	Miele 美諾	DA3190	DA3190	DA3190	DA3190	DA3190	DA3190
	Gas Cooking Hob 煤氣煮食爐	Miele 美諾	CS1018G CS1013G	CS1018G CS1013G	CS1018G CS1013G	CS1018G CS1013G	CS1018G CS1013G	CS1018G CS1013G
	Gas Water Heater 煤氣熱水爐	TGC	NJW160TFQL <sup>(1)</sup>	NJW160TFQL <sup>(1)</sup>	NJW220TFQL <sup>(2)</sup>	NJW160TFQL <sup>(1)</sup>	NJW160TFQL <sup>(1)</sup>	NJW220TFQL <sup>(2)</sup>
	Microwave Oven 微波爐	Miele 美諾	M8161-2	M8161-2	M8161-2	M8161-2	M8161-2	M8161-2
	Refrigerator 雪櫃	Siemens 西門子	KI38VA/ KU15R	KI38VA/ KU15R	KI38VA	KI38VA/ KU15R	KI38VA/ KU15R	KI38VA
	Washer/Dryer 洗衣/乾衣機	Siemens 西門子	WK16D	WK16D	WK16D	WK16D	WK16D	WK16D
	Exhaust Fan 抽氣扇	Xpelair	GX 6	GX 6	GX 6	GX 6	GX 6	GX 6

The vendor undertakes that if lifts and appliances of the specified brand name or model number are not installed in the Development, lifts or appliances of comparable quality will be installed.  
賣方承諾如該發展項目中沒有安裝指明的品牌名稱或產品型號的升降機或設備，便會安裝品質相若的升降機或設備。

#### Notes:

- The residential floors start from 7/F in all towers of the Development.
  - There is no Tower 4 in the Development.
  - There are no 4/F, 13/F, 14/F, 24/F and 34/F in all towers of the Development.
  - There are no 6/F and 19/F in Tower 1 and Tower 2 and no 20/F and 21/F in Tower 6, Tower 7, Tower 9 and Tower 10.
  - There are no 2/F in Tower 3, Tower 5, Tower 6, Tower 7, Tower 8, Tower 9 and Tower 10.
  - The symbol “-” as shown in the above table denotes “Not Provided”.
  - The cells shaded in grey “■” as shown in the above table denotes “Not Applicable”.
- (1) : The gas water heater located at A/C room & served for Lavatory leading from Kitchen, Kitchen and Bathroom  
(2) : The gas water heater located at A/C room & served for Kitchen and Bathroom  
(3) : The gas water heater located at A/C room & served for Lavatory near to Living Room and Bathroom in Ensuite Bedroom

#### 備註：

- 發展項目內所有座樓之住宅由7樓開始。
  - 發展項目不設第4座。
  - 發展項目內所有座樓均不設4樓、13樓、14樓、24樓及34樓。
  - 第1座及第2座均不設6樓及19樓；第6座、第7座、第9座及第10座均不設20樓及21樓。
  - 第3座、第5座、第6座、第7座、第8座、第9座及第10座均不設2樓。
  - 上表內之“-”符號代表“沒有提供”。
  - 上表內填上灰色“■”之部分代表“不適用”。
- (1) : 該款煤氣熱水爐位於冷氣機房及供應熱水給由廚房通往之洗手間、廚房和浴室  
(2) : 該款煤氣熱水爐位於冷氣機房及供應熱水給廚房和浴室  
(3) : 該款煤氣熱水爐位於冷氣機房及供應熱水給鄰近客廳之洗手間和套房內之浴室

# FITTINGS, FINISHES AND APPLIANCES

## 裝置、裝修物料及設備

### Appliances Schedule 設備說明表

#### Tower 6 第6座

Location 位置	Appliances 設備	Brand Name 品牌名稱	22/F to 25/F 22樓至25樓		38/F to 39/F 38樓至39樓	38/F & 39/F 38樓及39樓
			A	C	A	C
			Model Number 產品型號			
Kitchen 廚房	Cooker Hood 抽油煙機	Miele 美諾	DA3190	DA3190	DA422-4	DA422-4
	Gas Cooking Hob 煤氣煮食爐	Miele 美諾	CS1018G CS1013G	CS1018G CS1013G	CS1018G CS1013G	CS1018G CS1013G
	Gas Water Heater 煤氣熱水爐	TGC	NJW160TFQL <sup>(1)</sup>	NJW220TFQL <sup>(2)</sup>	NJW220TFQL <sup>(1)</sup>	NJW220TFQL <sup>(1)</sup>
	Microwave Oven 微波爐	Miele 美諾	M8161-2	M8161-2	M8161-2	M8161-2
	Refrigerator 雪櫃	Siemens 西門子	KI38VA/ KU15R	KI38VA	-	-
		Sub zero	-	-	ICBBI-42S	ICBBI-42S
	Washer/Dryer 洗衣/乾衣機	Miele 美諾	-	-	WT2789i	WT2789i
		Siemens 西門子	WK16D	WK16D	-	-
Exhaust Fan 抽氣扇	Xpelair	GX 6	GX 6	GX 6	GX 6	

The vendor undertakes that if lifts and appliances of the specified brand name or model number are not installed in the Development, lifts or appliances of comparable quality will be installed.  
賣方承諾如該發展項目中沒有安裝指明的品牌名稱或產品型號的升降機或設備，便會安裝品質相若的升降機或設備。

#### Notes:

- The residential floors start from 7/F in all towers of the Development.
  - There is no Tower 4 in the Development.
  - There are no 4/F, 13/F, 14/F, 24/F and 34/F in all towers of the Development.
  - There are no 6/F and 19/F in Tower 1 and Tower 2 and no 20/F and 21/F in Tower 6, Tower 7, Tower 9 and Tower 10.
  - There are no 2/F in Tower 3, Tower 5, Tower 6, Tower 7, Tower 8, Tower 9 and Tower 10.
  - The symbol “-” as shown in the above table denotes “Not Provided”.
  - The cells shaded in grey “■” as shown in the above table denotes “Not Applicable”.
- (1) : The gas water heater located at A/C room & served for Lavatory leading from Kitchen, Kitchen and Bathroom  
(2) : The gas water heater located at A/C room & served for Kitchen and Bathroom  
(3) : The gas water heater located at A/C room & served for Lavatory near to Living Room and Bathroom in Ensuite Bedroom

#### 備註：

- 發展項目內所有座樓之住宅由7樓開始。
  - 發展項目不設第4座。
  - 發展項目內所有座樓均不設4樓、13樓、14樓、24樓及34樓。
  - 第1座及第2座均不設6樓及19樓；第6座、第7座、第9座及第10座均不設20樓及21樓。
  - 第3座、第5座、第6座、第7座、第8座、第9座及第10座均不設2樓。
  - 上表內之“-”符號代表“沒有提供”。
  - 上表內填上灰色“■”之部分代表“不適用”。
- (1) : 該款煤氣熱水爐位於冷氣機房及供應熱水給由廚房通往之洗手間、廚房和浴室  
(2) : 該款煤氣熱水爐位於冷氣機房及供應熱水給廚房和浴室  
(3) : 該款煤氣熱水爐位於冷氣機房及供應熱水給鄰近客廳之洗手間和套房內之浴室

# FITTINGS, FINISHES AND APPLIANCES

## 裝置、裝修物料及設備

### Appliances Schedule 設備說明表

#### Tower 6 第6座

Location 位置	Appliances 設備	Brand Name 品牌名稱	7/F 7樓			8/F to 19/F & 26/F to 37/F 8樓至19樓及26樓至37樓		
			A	B	C	A	B	C
			Model Number 產品型號					
Kitchen 廚房	Induction Hob 電磁爐	Miele 美諾	CS1212	CS1212	-	CS1212	CS1212	-
	Steam Oven 電蒸爐	Miele 美諾	DGC5051	DGC5051	DGC5051	DGC5051	DGC5051	DGC5051
	Wine Cellar 酒櫃	Miele 美諾	KWT4154UG-1	KWT4154UG-1	KWT4154UG-1	KWT4154UG-1	KWT4154UG-1	KWT4154UG-1
	Door Bell 門鐘	Hager 海格	XC001	XC001	XC001	XC001	XC001	XC001
Bathroom in Master Bedroom 主人房內之浴室	10"LCD TV 10"液晶電視	JSA	TMBG10i	TMBG10i	-	TMBG10i	TMBG10i	-
	Gas Water Heater 煤氣熱水爐	TGC	NJW220TFQL	NJW220TFQL	NJW220TFQL	NJW220TFQL	NJW220TFQL	NJW220TFQL
	Exhaust Fan 抽氣扇	Ostberg 奧斯博格	RFE 140B	RFE 140B	-	RFE 140B	RFE 140B	-
		Xeplair	-	-	GX 6	-	-	GX 6

The vendor undertakes that if lifts and appliances of the specified brand name or model number are not installed in the Development, lifts or appliances of comparable quality will be installed.  
賣方承諾如該發展項目中沒有安裝指明的品牌名稱或產品型號的升降機或設備，便會安裝品質相若的升降機或設備。

#### Notes:

- The residential floors start from 7/F in all towers of the Development.
- There is no Tower 4 in the Development.
- There are no 4/F, 13/F, 14/F, 24/F and 34/F in all towers of the Development.
- There are no 6/F and 19/F in Tower 1 and Tower 2 and no 20/F and 21/F in Tower 6, Tower 7, Tower 9 and Tower 10.
- There are no 2/F in Tower 3, Tower 5, Tower 6, Tower 7, Tower 8, Tower 9 and Tower 10.
- The symbol "-" as shown in the above table denotes "Not Provided".
- The cells shaded in grey "■" as shown in the above table denotes "Not Applicable".

#### 備註：

- 發展項目內所有座樓之住宅由7樓開始。
- 發展項目不設第4座。
- 發展項目內所有座樓均不設4樓、13樓、14樓、24樓及34樓。
- 第1座及第2座均不設6樓及19樓；第6座、第7座、第9座及第10座均不設20樓及21樓。
- 第3座、第5座、第6座、第7座、第8座、第9座及第10座均不設2樓。
- 上表內之“-”符號代表“沒有提供”。
- 上表內填上灰色“■”之部分代表“不適用”。



# FITTINGS, FINISHES AND APPLIANCES

## 裝置、裝修物料及設備

### Appliances Schedule 設備說明表

#### Tower 6 第6座

Location 位置	Appliances 設備	Brand Name 品牌名稱	22/F to 25/F 22樓至25樓		38/F to 39/F 38樓至39樓	
			A	C	A	C
			Model Number 產品型號			
Kitchen 廚房	Induction Hob 電磁爐	Miele 美諾	CS1212	-	CS1212	CS1212
	Steam Oven 電蒸爐	Miele 美諾	DGC5051	DGC5051	DGC5051	DGC5051
	Wine Cellar 酒櫃	Miele 美諾	KWT4154UG-1	KWT4154UG-1	KWT4154UG-1	KWT4154UG-1
	Door Bell 門鐘	Hager 海格	XC001	XC001	XC001	XC001
	Videophone 視像對講機	Bitron	-	-	AV2850/1	AV2850/1
Bathroom in Master Bedroom 主人房內之浴室	15"LCD TV 15"液晶體電視	JSA	-	-	TMBG15	TMBG15
	10"LCD TV 10"液晶體電視	JSA	TMBG10i	-	-	-
	Ceiling Speaker 揚聲器	KEF	-	-	2 x Cs130.2FS	2 x Cs130.2FS
	Gas Water Heater 煤氣熱水爐	TGC	NJW220TFQL	NJW220TFQL	NJW220TFQL	NJW220TFQL
	Exhaust Fan 抽氣扇	Ostberg 奧斯博格	RFE 140B	-	REF-200B	RFE 140B
Xpelair		-	GX 6	-	-	

The vendor undertakes that if lifts and appliances of the specified brand name or model number are not installed in the Development, lifts or appliances of comparable quality will be installed.  
賣方承諾如該發展項目中沒有安裝指明的品牌名稱或產品型號的升降機或設備，便會安裝品質相若的升降機或設備。

#### Notes:

- The residential floors start from 7/F in all towers of the Development.
- There is no Tower 4 in the Development.
- There are no 4/F, 13/F, 14/F, 24/F and 34/F in all towers of the Development.
- There are no 6/F and 19/F in Tower 1 and Tower 2 and no 20/F and 21/F in Tower 6, Tower 7, Tower 9 and Tower 10.
- There are no 2/F in Tower 3, Tower 5, Tower 6, Tower 7, Tower 8, Tower 9 and Tower 10.
- The symbol “-” as shown in the above table denotes “Not Provided”.
- The cells shaded in grey “■” as shown in the above table denotes “Not Applicable”.

#### 備註：

- 發展項目內所有座樓之住宅由7樓開始。
- 發展項目不設第4座。
- 發展項目內所有座樓均不設4樓、13樓、14樓、24樓及34樓。
- 第1座及第2座均不設6樓及19樓；第6座、第7座、第9座及第10座均不設20樓及21樓。
- 第3座、第5座、第6座、第7座、第8座、第9座及第10座均不設2樓。
- 上表內之“-”符號代表“沒有提供”。
- 上表內填上灰色“■”之部分代表“不適用”。

# FITTINGS, FINISHES AND APPLIANCES

## 裝置、裝修物料及設備

### Appliances Schedule 設備說明表

#### Tower 6 第6座

Location 位置	Appliances 設備	Brand Name 品牌名稱	7/F 7樓			8/F to 19/F & 26/F to 37/F 8樓至19樓及26樓至37樓		
			A	B	C	A	B	C
			Model Number 產品型號					
Bathroom 浴室	Gas Water Heater 煤氣熱水爐	TGC	NJW160TFQL <sup>(1)</sup>	NJW160TFQL <sup>(1)</sup>	NJW220TFQL <sup>(2)</sup>	NJW160TFQL <sup>(1)</sup>	NJW160TFQL <sup>(1)</sup>	NJW220TFQL <sup>(2)</sup>
	Exhaust Fan 抽氣扇	Ostberg 奧斯博格	RFE 140B	RFE 140B	RFE 140A	RFE 140A	RFE 140A	RFE 140A
Lavatory leading from Kitchen 由廚房通往之 洗手間	Gas Water Heater 煤氣熱水爐	TGC	NJW160TFQL <sup>(1)</sup>	NJW160TFQL <sup>(1)</sup>		NJW160TFQL <sup>(1)</sup>	NJW160TFQL <sup>(1)</sup>	
	Exhaust Fan 抽氣扇	Xpelair	GX-6	GX-6		GX-6	GX-6	

The vendor undertakes that if lifts and appliances of the specified brand name or model number are not installed in the Development, lifts or appliances of comparable quality will be installed.  
賣方承諾如該發展項目中沒有安裝指明的品牌名稱或產品型號的升降機或設備，便會安裝品質相若的升降機或設備。

#### Notes:

- The residential floors start from 7/F in all towers of the Development.
  - There is no Tower 4 in the Development.
  - There are no 4/F, 13/F, 14/F, 24/F and 34/F in all towers of the Development.
  - There are no 6/F and 19/F in Tower 1 and Tower 2 and no 20/F and 21/F in Tower 6, Tower 7, Tower 9 and Tower 10.
  - There are no 2/F in Tower 3, Tower 5, Tower 6, Tower 7, Tower 8, Tower 9 and Tower 10.
  - The symbol “-” as shown in the above table denotes “Not Provided”.
  - The cells shaded in grey “■” as shown in the above table denotes “Not Applicable”.
- (1) : The gas water heater located at A/C room & served for Lavatory leading from Kitchen, Kitchen and Bathroom  
(2) : The gas water heater located at A/C room & served for Kitchen and Bathroom  
(3) : The gas water heater located at A/C room & served for Lavatory near to Living Room and Bathroom in Ensuite Bedroom

#### 備註：

- 發展項目內所有座樓之住宅由7樓開始。
  - 發展項目不設第4座。
  - 發展項目內所有座樓均不設4樓、13樓、14樓、24樓及34樓。
  - 第1座及第2座均不設6樓及19樓；第6座、第7座、第9座及第10座均不設20樓及21樓。
  - 第3座、第5座、第6座、第7座、第8座、第9座及第10座均不設2樓。
  - 上表內之“-”符號代表“沒有提供”。
  - 上表內填上灰色“■”之部分代表“不適用”。
- (1) : 該款煤氣熱水爐位於冷氣機房及供應熱水給由廚房通往之洗手間、廚房和浴室  
(2) : 該款煤氣熱水爐位於冷氣機房及供應熱水給廚房和浴室  
(3) : 該款煤氣熱水爐位於冷氣機房及供應熱水給鄰近客廳之洗手間和套房內之浴室

# FITTINGS, FINISHES AND APPLIANCES

## 裝置、裝修物料及設備

### Appliances Schedule 設備說明表

#### Tower 6 第6座

Location 位置	Appliances 設備	Brand Name 品牌名稱	22/F to 25/F 22樓至25樓		38/F to 39/F 38樓至39樓	38/F & 39/F 38樓及39樓
			A	C	A	C
			Model Number 產品型號			
Bathroom 浴室	Gas Water Heater 煤氣熱水爐	TGC	NJW160TFQL <sup>(1)</sup>	NJW220TFQL <sup>(2)</sup>	NJW220TFQL <sup>(1)</sup>	NJW220TFQL <sup>(1)</sup>
	Exhaust Fan 抽氣扇	Ostberg 奧斯博格	RFE 140A	RFE 140A	RFE 140A	RFE 140B
Bathroom in Ensuite Bedroom 睡房內之浴室	Gas Water Heater 煤氣熱水爐	TGC			NJW220TFQL <sup>(3)</sup>	NJW160TFQL <sup>(1)</sup>
	Exhaust Fan 抽氣扇	Ostberg 奧斯博格			RFE 140A	RFE 140B
Lavatory near to Living Room 鄰近客廳之 洗手間	Gas Water Heater 煤氣熱水爐	TGC			NJW220TFQL <sup>(3)</sup>	
	Exhaust Fan 抽氣扇	Ostberg 奧斯博格			RFE 140A	
Lavatory leading from Kitchen 由廚房通往之 洗手間	Gas Water Heater 煤氣熱水爐	TGC	NJW160TFQL <sup>(1)</sup>		NJW220TFQL <sup>(1)</sup>	NJW220TFQL <sup>(1)</sup>
	Exhaust Fan 抽氣扇	Xpelair	GX-6		GX-6	-
		Ostberg 奧斯博格	-		-	RFE 140A

The vendor undertakes that if lifts and appliances of the specified brand name or model number are not installed in the Development, lifts or appliances of comparable quality will be installed.  
賣方承諾如該發展項目中沒有安裝指明的品牌名稱或產品型號的升降機或設備，便會安裝品質相若的升降機或設備。

#### Notes:

- The residential floors start from 7/F in all towers of the Development.
  - There is no Tower 4 in the Development.
  - There are no 4/F, 13/F, 14/F, 24/F and 34/F in all towers of the Development.
  - There are no 6/F and 19/F in Tower 1 and Tower 2 and no 20/F and 21/F in Tower 6, Tower 7, Tower 9 and Tower 10.
  - There are no 2/F in Tower 3, Tower 5, Tower 6, Tower 7, Tower 8, Tower 9 and Tower 10.
  - The symbol “-” as shown in the above table denotes “Not Provided”.
  - The cells shaded in grey “■” as shown in the above table denotes “Not Applicable”.
- (1) : The gas water heater located at A/C room & served for Lavatory leading from Kitchen, Kitchen and Bathroom  
(2) : The gas water heater located at A/C room & served for Kitchen and Bathroom  
(3) : The gas water heater located at A/C room & served for Lavatory near to Living Room and Bathroom in Ensuite Bedroom

#### 備註：

- 發展項目內所有座樓之住宅由7樓開始。
  - 發展項目不設第4座。
  - 發展項目內所有座樓均不設4樓、13樓、14樓、24樓及34樓。
  - 第1座及第2座均不設6樓及19樓；第6座、第7座、第9座及第10座均不設20樓及21樓。
  - 第3座、第5座、第6座、第7座、第8座、第9座及第10座均不設2樓。
  - 上表內之“-”符號代表“沒有提供”。
  - 上表內填上灰色“■”之部分代表“不適用”。
- (1) : 該款煤氣熱水爐位於冷氣機房及供應熱水給由廚房通往之洗手間、廚房和浴室  
(2) : 該款煤氣熱水爐位於冷氣機房及供應熱水給廚房和浴室  
(3) : 該款煤氣熱水爐位於冷氣機房及供應熱水給鄰近客廳之洗手間和套房內之浴室

# FITTINGS, FINISHES AND APPLIANCES

## 裝置、裝修物料及設備

### Schedule of Mechanical and Electrical Provisions 機電裝置數量說明表

#### Tower 6 第6座

Location 位置	Exposed Type 外露型	Non-Exposed Type 非外露型	7/F 7樓			8/F to 19/F & 26/F to 37/F 8樓至19樓及26樓至37樓			22/F to 25/F 22樓至25樓		38/F 38樓		39/F 39樓		
			A	B	C	A	B	C	A	C	A	C	A	C	
Living Room, Dining Room & Corridor 客廳、飯廳及 走廊	TV/ FM Outlet 電視/電台天線插座		3	3	2	3	3	2	3	2	2	2	2	-	
	Telephone Outlet 電話插座		2	2	2	2	2	2	2	2	2	2	2	-	
	13A Twin Socket Outlet 13A雙位電插座		5	5	2	6	6	5	6	5	4	4	4	-	
	13A Single Socket Outlet 13A單位電插座		5	5	5	3	3	3	3	3	6	2	5	1	
	Lighting Switch 燈掣		7	7	7	6	6	7	6	7	8	4	8	2	
		Door Bell 門鐘		1	1	1	1	1	1	1	1	1	-	1	1
		Door Phone Handset 對講機		1	1	1	1	1	1	1	1	-	-	-	-
		20A Double Pole Switch with Pilot Lamp 20A 雙極開關掣		2	2	2	2	2	2	2	2	2	1	2	-
	Fused Spur Unit/Connection Unit 接線座		1	1	1	1	1	1	1	1	1	-	1	-	
Master Bedroom 主人房	TV/ FM Outlet 電視/電台天線插座		2	2	1	2	2	1	2	1	2		2	2	
	Telephone Outlet 電話插座		2	2	1	2	2	1	2	1	2		2	2	
	13A Twin Socket Outlet 13A雙位電插座		3	3	3	3	3	3	3	3	6		6	4	
	13A Single Socket Outlet 13A單位電插座		2	1	1	2	2	1	2	1	-		-	3	
	Lighting Switch 燈掣		4	4	2	4	4	2	4	2	3		3	4	
	20A Double Pole Switch with Pilot Lamp 20A 雙極開關掣		1	1	1	1	1	1	1	1	2		2	2	

#### Notes:

- The residential floors start from 7/F in all towers of the Development.
- There is no Tower 4 in the Development.
- There are no 4/F, 13/F, 14/F, 24/F and 34/F in all towers of the Development.
- There are no 6/F and 19/F in Tower 1 and Tower 2 and no 20/F and 21/F in Tower 6, Tower 7, Tower 9 and Tower 10.
- There are no 2/F in Tower 3, Tower 5, Tower 6, Tower 7, Tower 8, Tower 9 and Tower 10.
- The symbol “-” as shown in the above table denotes “Not Provided”.
- The cells shaded in grey “■” as shown in the above table denotes “Not Applicable”.

#### 備註:

- 發展項目內所有座樓之住宅由7樓開始。
- 發展項目不設第4座。
- 發展項目內所有座樓均不設4樓、13樓、14樓、24樓及34樓。
- 第1座及第2座均不設6樓及19樓；第6座、第7座、第9座及第10座均不設20樓及21樓。
- 第3座、第5座、第6座、第7座、第8座、第9座及第10座均不設2樓。
- 上表內之“-”符號代表“沒有提供”。
- 上表內填上灰色“■”之部分代表“不適用”。

# FITTINGS, FINISHES AND APPLIANCES

## 裝置、裝修物料及設備

### Schedule of Mechanical and Electrical Provisions 機電裝置數量說明表

#### Tower 6 第6座

Location 位置	Exposed Type 外露型	Non-Exposed Type 非外露型	7/F 7樓			8/F to 19/F & 26/F to 37/F 8樓至19樓及26樓至37樓			22/F to 25/F 22樓至25樓		38/F 38樓		39/F 39樓	
			A	B	C	A	B	C	A	C	A	C	A	C
Bedroom 1 睡房1	TV/ FM Outlet 電視/電台天線插座				1			1		1	2	2	2	
	Telephone Outlet 電話插座			1			1		1	2	1	2		
	13A Twin Socket Outlet 13A雙位電插座			1			1		1	2	2	2		
	13A Single Socket Outlet 13A單位電插座			1			1		1	-	2	-		
	Lighting Switch 燈掣			1			1		1	2	1	2		
Bedroom 2 睡房2	TV/ FM Outlet 電視/電台天線插座				1			1		1				
	Telephone Outlet 電話插座			1			1		1					
	13A Twin Socket Outlet 13A雙位電插座			2			2		2					
	Lighting Switch 燈掣			1			1		1					

#### Notes:

- The residential floors start from 7/F in all towers of the Development.
- There is no Tower 4 in the Development.
- There are no 4/F, 13/F, 14/F, 24/F and 34/F in all towers of the Development.
- There are no 6/F and 19/F in Tower 1 and Tower 2 and no 20/F and 21/F in Tower 6, Tower 7, Tower 9 and Tower 10.
- There are no 2/F in Tower 3, Tower 5, Tower 6, Tower 7, Tower 8, Tower 9 and Tower 10.
- The symbol “-” as shown in the above table denotes “Not Provided”.
- The cells shaded in grey “■” as shown in the above table denotes “Not Applicable”.

#### 備註：

- 發展項目內所有座樓之住宅由7樓開始。
- 發展項目不設第4座。
- 發展項目內所有座樓均不設4樓、13樓、14樓、24樓及34樓。
- 第1座及第2座均不設6樓及19樓；第6座、第7座、第9座及第10座均不設20樓及21樓。
- 第3座、第5座、第6座、第7座、第8座、第9座及第10座均不設2樓。
- 上表內之“-”符號代表“沒有提供”。
- 上表內填上灰色“■”之部分代表“不適用”。

# FITTINGS, FINISHES AND APPLIANCES

## 裝置、裝修物料及設備

### Schedule of Mechanical and Electrical Provisions 機電裝置數量說明表

#### Tower 6 第6座

Location 位置	Exposed Type 外露型	Non-Exposed Type 非外露型	7/F 7樓			8/F to 19/F & 26/F to 37/F 8樓至19樓及26樓至37樓			22/F to 25/F 22樓至25樓		38/F 38樓		39/F 39樓	
			A	B	C	A	B	C	A	C	A	C	A	C
Ensuite Bedroom 套房	TV/ FM Outlet 電視/電台天線插座										2		2	1
	Telephone Outlet 電話插座										1		1	1
	13A Twin Socket Outlet 13A雙位電插座										4		4	2
	13A Single Socket Outlet 13A單位電插座										2		2	1
	Lighting Switch 燈掣										4		3	2
	20A Double Pole Switch with Pilot Lamp 20A 雙極開關掣										1		1	1
Store 士多房	TV/ FM Outlet 電視/電台天線插座		1	1	1	1	1	1	1	1	1	1	1	
	Telephone Outlet 電話插座		-	-	-	-	-	-	-	-	1	1	1	
	13A Twin Socket Outlet 13A雙位電插座		1	1	1	1	1	1	1	1	1	1	1	
	Lighting Switch 燈掣		1	1	1	1	1	1	1	1	1	1	1	
	20A Double Pole Switch with Pilot Lamp 20A 雙極開關掣		1	1	-	1	1	-	1	-	1	1	1	
Store under Staircase 樓梯下的 士多房	Lighting Switch 燈掣											1		

#### Notes:

- The residential floors start from 7/F in all towers of the Development.
- There is no Tower 4 in the Development.
- There are no 4/F, 13/F, 14/F, 24/F and 34/F in all towers of the Development.
- There are no 6/F and 19/F in Tower 1 and Tower 2 and no 20/F and 21/F in Tower 6, Tower 7, Tower 9 and Tower 10.
- There are no 2/F in Tower 3, Tower 5, Tower 6, Tower 7, Tower 8, Tower 9 and Tower 10.
- The symbol “-” as shown in the above table denotes “Not Provided”.
- The cells shaded in grey “■” as shown in the above table denotes “Not Applicable”.

#### 備註:

- 發展項目內所有座樓之住宅由7樓開始。
- 發展項目不設第4座。
- 發展項目內所有座樓均不設4樓、13樓、14樓、24樓及34樓。
- 第1座及第2座均不設6樓及19樓；第6座、第7座、第9座及第10座均不設20樓及21樓。
- 第3座、第5座、第6座、第7座、第8座、第9座及第10座均不設2樓。
- 上表內之“-”符號代表“沒有提供”。
- 上表內填上灰色“■”之部分代表“不適用”。

# FITTINGS, FINISHES AND APPLIANCES

## 裝置、裝修物料及設備

Schedule of Mechanical and Electrical Provisions  
機電裝置數量說明表

### Tower 6 第6座

Location 位置	Exposed Type 外露型	Non-Exposed Type 非外露型	7/F 7樓			8/F to 19/F & 26/F to 37/F 8樓至19樓及26樓至37樓			22/F to 25/F 22樓至25樓		38/F 38樓		39/F 39樓	
			A	B	C	A	B	C	A	C	A	C	A	C
Bathroom in Master Bedroom 主人房內之浴室	TV / FM Outlet 電視/電台天線插座		1	1	1	1	1	1	1	1	1		1	1
	13A Single Socket Outlet 13A單位電插座		2	2	2	3	2	3	2	2	3		3	3
		Fused Spur Unit/Connection Unit接線座	1	1	1	1	1	1	1	1	1		1	1
Bathroom in Ensuite Bedroom 套房內之浴室	TV / FM Outlet 電視/電台天線插座										-		1	-
	13A Single Socket Outlet 13A單位電插座										1		1	1
		Fused Spur Unit/Connection Unit 接線座									1		1	1
Bathroom 浴室	TV / FM Outlet 電視/電台天線插座		-	-	-	1	-	1	-	-	-	-	1	
	13A Single Socket Outlet 13A單位電插座		1	1	1	3	1	3	1	1	1	1	1	
		Fused Spur Unit/Connection Unit接線座	1	1	1	1	1	1	1	1	1	1	1	
Lavatory near to Living Room 鄰近客廳之 洗手間	13A Single Socket Outlet 13A單位電插座										1		1	
		Fused Spur Unit/Connection Unit 接線座									1		1	
Lavatory leading from Kitchen 由廚房通往之 洗手間		Fused Spur Unit/Connection Unit 接線座	1	1		1	1		1		1	1	1	

Notes:

- The residential floors start from 7/F in all towers of the Development.
- There is no Tower 4 in the Development.
- There are no 4/F, 13/F, 14/F, 24/F and 34/F in all towers of the Development.
- There are no 6/F and 19/F in Tower 1 and Tower 2 and no 20/F and 21/F in Tower 6, Tower 7, Tower 9 and Tower 10.
- There are no 2/F in Tower 3, Tower 5, Tower 6, Tower 7, Tower 8, Tower 9 and Tower 10.
- The symbol “-” as shown in the above table denotes “Not Provided”.
- The cells shaded in grey “■” as shown in the above table denotes “Not Applicable”.

備註：

- 發展項目內所有座樓之住宅由7樓開始。
- 發展項目不設第4座。
- 發展項目內所有座樓均不設4樓、13樓、14樓、24樓及34樓。
- 第1座及第2座均不設6樓及19樓；第6座、第7座、第9座及第10座均不設20樓及21樓。
- 第3座、第5座、第6座、第7座、第8座、第9座及第10座均不設2樓。
- 上表內之“-”符號代表“沒有提供”。
- 上表內填上灰色“■”之部分代表“不適用”。

# FITTINGS, FINISHES AND APPLIANCES

## 裝置、裝修物料及設備

### Schedule of Mechanical and Electrical Provisions

#### 機電裝置數量說明表

#### Tower 6 第6座

Location 位置	Exposed Type 外露型	Non-Exposed Type 非外露型	7/F 7樓			8/F to 19/F & 26/F to 37/F 8樓至19樓及26樓至37樓			22/F to 25/F 22樓至25樓		38/F 38樓		39/F 39樓		
			A	B	C	A	B	C	A	C	A	C	A	C	
Kitchen 廚房	13A Twin Socket Outlet 13A雙位電插座		1	1	1	1	1	1	1	1	3	2	3		
	13A Twin Socket Outlet 13A雙位電插座		1	1	1	1	1	1	1	1	-	-	-		
	13A Single Socket Outlet 13A單位電插座		7	7	6	7	7	6	7	6	7	7	7		
	13A Single Socket Outlet 13A單位電插座		-	-	1	-	-	6	-	6	-	-	-		
	Lighting Switch 燈掣		-	-	-	-	-	-	-	-	1	1	1		
	Door Bell 門鐘		1	1	1	1	1	1	1	1	1	1	1		
	Door Phone Handset 對講機		-	-	-	-	-	-	-	-	1	1	1		
	20A Double Pole Switch with Pilot Lamp 20A 雙極開關掣		1	1	1	1	1	1	1	1	1	1	1	1	
	Fused Spur Unit/Connection Unit 接線座		3	3	2	3	3	2	3	2	3	3	3		
	Drain Point For Washing Machine 去水位供洗衣機		1	1	1	1	1	1	1	1	1	1	1	1	
Water Point For Washing Machine 來水位供洗衣機		1	1	1	1	1	1	1	1	1	1	1	1		
Stairhood 梯屋	Lighting Switch 燈掣												2	2	
Flat Roof 平台	13A Weather Proof Single / Twin Socket Outlet 13A 防水單位/雙位電插座		2	2	1	-(#)					1			1	
Roof 天台	13A Weather Proof Single / Twin Socket Outlet 13A 防水單位/雙位電插座												1	1	

#### Notes:

- The residential floors start from 7/F in all towers of the Development.
- There is no Tower 4 in the Development.
- There are no 4/F, 13/F, 14/F, 24/F and 34/F in all towers of the Development.
- There are no 6/F and 19/F in Tower 1 and Tower 2 and no 20/F and 21/F in Tower 6, Tower 7, Tower 9 and Tower 10.
- There are no 2/F in Tower 3, Tower 5, Tower 6, Tower 7, Tower 8, Tower 9 and Tower 10.
- The symbol “-” as shown in the above table denotes “Not Provided”.
- The cells shaded in grey “■” as shown in the above table denotes “Not Applicable”.
- The provision mark with “#” only apply to Flat A of 16/F. There is no Flat Roof for other floors.

#### 備註:

- 發展項目內所有座樓之住宅由7樓開始。
- 發展項目不設第4座。
- 發展項目內所有座樓均不設4樓、13樓、14樓、24樓及34樓。
- 第1座及第2座均不設6樓及19樓；第6座、第7座、第9座及第10座均不設20樓及21樓。
- 第3座、第5座、第6座、第7座、第8座、第9座及第10座均不設2樓。
- 上表內之“-”符號代表“沒有提供”。
- 上表內填上灰色“■”之部分代表“不適用”。
- 註有“#”的數量只適用於16樓A單位，其餘樓層並沒有平台。



# FITTINGS, FINISHES AND APPLIANCES

## 裝置、裝修物料及設備

### Appliances Schedule 設備說明表

#### Tower 7 第7座

Location 位置	Appliances 設備	Brand Name 品牌名稱	7/F 7樓			8/F to 19/F & 26/F to 37/F 8樓至19樓及26樓至37樓		
			A	B	C	A	B	C
			Model Number 產品型號					
Living Room, Dining Room & Corridor 客廳、飯廳 及走廊	Split Type Air-Conditioner 分體式冷氣機	Panasonic	Indoor Unit 室內機			Indoor Unit 室內機		
			CS-E18JD4H(2NOS.)/ CS-E10HD3EA	CS-E23JD4H/ CS-E10HD3EA/ CS-E18HD3EA	CS-E23JD4H	CS-E18JD4H(2NOS.)/ CS-E10HD3EA	CS-E18JD4H/ CS-E10HD3EA/ CS-E18HD3EA	CS-E23JD4H
			Outdoor Unit 室外機			Outdoor Unit 室外機		
			CU-E18JBH(2NOS.)/ CU-2E18CBPGW (Shared Outdoor Unit) (共用室外組件)	CU-E23JBH/ CU-4E23JBE	CU-E23JBH	CU-E18JBH(2NOS.)/ CU-2E18CBPGW (Shared Outdoor Unit) (共用室外組件)	CS-E18JBH/ CU-4E23JBE	CU-E23JBH
Master Bedroom 主人房	Split Type Air-Conditioner 分體式冷氣機	Panasonic	Indoor Unit 室內機			Indoor Unit 室內機		
			CS-E18JD4H/ CS-E10HD3EA	CS-E18JD4H/ CS-E10HD3EA/ CS-E18HD3EA	CS-E12JD4H	CS-E18JD4H/ CS-E10HD3EA	CS-E18JD4H/ CS-E10HD3EA/ CS-E18HD3EA	CS-E12JD4H
			Outdoor Unit 室外機			Outdoor Unit 室外機		
			CU-E18JBH/ CU-2E18CBPGW (Shared Outdoor Unit) (共用室外組件)	CU-E18JBH/ CU-4E23JBE	CU-E12JBH	CU-E18JBH/ CU-2E18CBPGW (Shared Outdoor Unit) (共用室外組件)	CU-E18JBH/ CU-4E23JBE	CU-E12JBH

The vendor undertakes that if lifts and appliances of the specified brand name or model number are not installed in the Development, lifts or appliances of comparable quality will be installed.  
賣方承諾如該發展項目中沒有安裝指明的品牌名稱或產品型號的升降機或設備，便會安裝品質相若的升降機或設備。

#### Notes:

- The residential floors start from 7/F in all towers of the Development.
- There is no Tower 4 in the Development.
- There are no 4/F, 13/F, 14/F, 24/F and 34/F in all towers of the Development.
- There are no 6/F and 19/F in Tower 1 and Tower 2 and no 20/F and 21/F in Tower 6, Tower 7, Tower 9 and Tower 10.
- There are no 2/F in Tower 3, Tower 5, Tower 6, Tower 7, Tower 8, Tower 9 and Tower 10.
- The symbol “-” as shown in the above table denotes “Not Provided”.
- The cells shaded in grey “■” as shown in the above table denotes “Not Applicable”.

#### 備註：

- 發展項目內所有座樓之住宅由7樓開始。
- 發展項目不設第4座。
- 發展項目內所有座樓均不設4樓、13樓、14樓、24樓及34樓。
- 第1座及第2座均不設6樓及19樓；第6座、第7座、第9座及第10座均不設20樓及21樓。
- 第3座、第5座、第6座、第7座、第8座、第9座及第10座均不設2樓。
- 上表內之“-”符號代表“沒有提供”。
- 上表內填上灰色“■”之部分代表“不適用”。

# FITTINGS, FINISHES AND APPLIANCES

## 裝置、裝修物料及設備

### Appliances Schedule 設備說明表

#### Tower 7 第7座

Location 位置	Appliances 設備	Brand Name 品牌名稱	22/F to 25/F 22樓至25樓		38/F to 39/F 38樓至39樓	38/F to 39/F 38樓至39樓
			B	C	A	C
			Model Number 產品型號			
Living Room, Dining Room & Corridor 客廳、飯廳 及走廊	Split Type Air-Conditioner 分體式冷氣機	Panasonic	Indoor Unit 室內機		Indoor Unit 室內機	Indoor Unit 室內機
			CS-E18JD4H/ CS-E10HD3EA/ CS-E18HD3EA	CS-E23JD4H	CS-E18JD4H(3NOS)	CS-E18JD4H(2NOS)
			Outdoor Unit 室外機		Outdoor Unit 室外機	Outdoor Unit 室外機
			CU-E18JBH/ CU-4E23JBE	CU-E23JBH	CU-E18JBH(3NOS.)	CU-E18JBH(2NOS.)
Master Bedroom 主人房	Split Type Air-Conditioner 分體式冷氣機	Panasonic	Indoor Unit 室內機		Indoor Unit 室內機	Indoor Unit 室內機
			CS-E18JD4H/ CS-E10HD3EA/ CS-E18HD3EA	CS-E12JD4H	CS-E23JD4H	CS-E18JD4H
			Outdoor Unit 室外機		Outdoor Unit 室外機	Outdoor Unit 室外機
			CU-E18JBH/ CU-4E23JBE	CU-E12JBH	CU-E23JBH	CU-E18JBH

The vendor undertakes that if lifts and appliances of the specified brand name or model number are not installed in the Development, lifts or appliances of comparable quality will be installed.  
賣方承諾如該發展項目中沒有安裝指明的品牌名稱或產品型號的升降機或設備，便會安裝品質相若的升降機或設備。

#### Notes:

- The residential floors start from 7/F in all towers of the Development.
- There is no Tower 4 in the Development.
- There are no 4/F, 13/F, 14/F, 24/F and 34/F in all towers of the Development.
- There are no 6/F and 19/F in Tower 1 and Tower 2 and no 20/F and 21/F in Tower 6, Tower 7, Tower 9 and Tower 10.
- There are no 2/F in Tower 3, Tower 5, Tower 6, Tower 7, Tower 8, Tower 9 and Tower 10.
- The symbol “-” as shown in the above table denotes “Not Provided”.
- The cells shaded in grey “■” as shown in the above table denotes “Not Applicable”.

#### 備註：

- 發展項目內所有座樓之住宅由7樓開始。
- 發展項目不設第4座。
- 發展項目內所有座樓均不設4樓、13樓、14樓、24樓及34樓。
- 第1座及第2座均不設6樓及19樓；第6座、第7座、第9座及第10座均不設20樓及21樓。
- 第3座、第5座、第6座、第7座、第8座、第9座及第10座均不設2樓。
- 上表內之“-”符號代表“沒有提供”。
- 上表內填上灰色“■”之部分代表“不適用”。

# FITTINGS, FINISHES AND APPLIANCES

## 裝置、裝修物料及設備

### Appliances Schedule 設備說明表

#### Tower 7 第7座

Location 位置	Appliances 設備	Brand Name 品牌名稱	7/F 7樓			8/F to 19/F & 26/F to 37/F 8樓至19樓及26樓至37樓		
			A	B	C	A	B	C
			Model Number 產品型號					
Bedroom 1 睡房1	Split Type Air-Conditioner 分體式冷氣機	Panasonic	Indoor Unit 室內機			Indoor Unit 室內機		
					CS-E9JKEW			CS-E9JKEW
			Outdoor Unit 室外機			Outdoor Unit 室外機		
					CU-2E18CBPGW (Shared Outdoor Unit) (共用室外組件)			CU-2E18CBPGW (Shared Outdoor Unit) (共用室外組件)
Bedroom 2 睡房2	Split Type Air-Conditioner 分體式冷氣機	Panasonic	Indoor Unit 室內機			Indoor Unit 室內機		
					CS-E9JKEW			CS-E9JKEW
			Outdoor Unit 室外機			Outdoor Unit 室外機		
					CU-2E18CBPGW (Shared Outdoor Unit) (共用室外組件)			CU-2E18CBPGW (Shared Outdoor Unit) (共用室外組件)
	Door Bell 門鐘	Hager 海格			-			-

The vendor undertakes that if lifts and appliances of the specified brand name or model number are not installed in the Development, lifts or appliances of comparable quality will be installed.  
賣方承諾如該發展項目中沒有安裝指明的品牌名稱或產品型號的升降機或設備，便會安裝品質相若的升降機或設備。

#### Notes:

- The residential floors start from 7/F in all towers of the Development.
- There is no Tower 4 in the Development.
- There are no 4/F, 13/F, 14/F, 24/F and 34/F in all towers of the Development.
- There are no 6/F and 19/F in Tower 1 and Tower 2 and no 20/F and 21/F in Tower 6, Tower 7, Tower 9 and Tower 10.
- There are no 2/F in Tower 3, Tower 5, Tower 6, Tower 7, Tower 8, Tower 9 and Tower 10.
- The symbol “-” as shown in the above table denotes “Not Provided”.
- The cells shaded in grey “■” as shown in the above table denotes “Not Applicable”.

#### 備註：

- 發展項目內所有座樓之住宅由7樓開始。
- 發展項目不設4樓。
- 發展項目內所有座樓均不設4樓、13樓、14樓、24樓及34樓。
- 第1座及第2座均不設6樓及19樓；第6座、第7座、第9座及第10座均不設20樓及21樓。
- 第3座、第5座、第6座、第7座、第8座、第9座及第10座均不設2樓。
- 上表內之“-”符號代表“沒有提供”。
- 上表內填上灰色“■”之部分代表“不適用”。

# FITTINGS, FINISHES AND APPLIANCES

## 裝置、裝修物料及設備

### Appliances Schedule 設備說明表

#### Tower 7 第7座

Location 位置	Appliances 設備	Brand Name 品牌名稱	22/F to 25/F 22樓至25樓		38/F to 39/F 38樓至39樓	38/F & 39/F 38樓及39樓
			B	C	A	C
Model Number 產品型號						
Bedroom 1 睡房1	Split Type Air-Conditioner 分體式冷氣機	Panasonic	Indoor Unit 室內機		Indoor Unit 室內機	Indoor Unit 室內機
				CS-E9JKEW	CS-E12JD4H/ CS-E18JD4H	CS-E18JD4H
			Outdoor Unit 室外機		Outdoor Unit 室外機	Outdoor Unit 室外機
				CU-2E18CBPGW (Shared Outdoor Unit) (共用室外組件)	CU-E12JBH/ CU-E18JBH	CU-E18JBH
Bedroom 2 睡房2	Split Type Air-Conditioner 分體式冷氣機	Panasonic	Indoor Unit 室內機		Indoor Unit 室內機	Indoor Unit 室內機
				CS-E9JKEW		
			Outdoor Unit 室外機		Outdoor Unit 室外機	Outdoor Unit 室外機
				CU-2E18CBPGW (Shared Outdoor Unit) (共用室外組件)		

The vendor undertakes that if lifts and appliances of the specified brand name or model number are not installed in the Development, lifts or appliances of comparable quality will be installed.  
賣方承諾如該發展項目中沒有安裝指明的品牌名稱或產品型號的升降機或設備，便會安裝品質相若的升降機或設備。

#### Notes:

- The residential floors start from 7/F in all towers of the Development.
- There is no Tower 4 in the Development.
- There are no 4/F, 13/F, 14/F, 24/F and 34/F in all towers of the Development.
- There are no 6/F and 19/F in Tower 1 and Tower 2 and no 20/F and 21/F in Tower 6, Tower 7, Tower 9 and Tower 10.
- There are no 2/F in Tower 3, Tower 5, Tower 6, Tower 7, Tower 8, Tower 9 and Tower 10.
- The symbol “-” as shown in the above table denotes “Not Provided”.
- The cells shaded in grey “■” as shown in the above table denotes “Not Applicable”.

#### 備註：

- 發展項目內所有座樓之住宅由7樓開始。
- 發展項目不設第4座。
- 發展項目內所有座樓均不設4樓、13樓、14樓、24樓及34樓。
- 第1座及第2座均不設6樓及19樓；第6座、第7座、第9座及第10座均不設20樓及21樓。
- 第3座、第5座、第6座、第7座、第8座、第9座及第10座均不設2樓。
- 上表內之“-”符號代表“沒有提供”。
- 上表內填上灰色“■”之部分代表“不適用”。

# FITTINGS, FINISHES AND APPLIANCES

## 裝置、裝修物料及設備

### Appliances Schedule 設備說明表

#### Tower 7 第7座

Location 位置	Appliances 設備	Brand Name 品牌名稱	7/F 7樓			8/F to 19/F & 26/F to 37/F 8樓至19樓及26樓至37樓		
			A	B	C	A	B	C
			Model Number 產品型號					
Kitchen 廚房	Split Type Air-Conditioner 分體式冷氣機	Panasonic	Indoor Unit 室內機			Indoor Unit 室內機		
			CS-E15HD3EA	CS-E15HD3EA	-	CS-E15HD3EA	CS-E15HD3EA	-
			Outdoor Unit 室外機			Outdoor Unit 室外機		
			CU-4E23JBE (Shared Outdoor Unit) (共用室外組件)	CU -4E23JBE (Shared Outdoor Unit) (共用室外組件)	-	CU-4E23JBE (Shared Outdoor Unit) (共用室外組件)	CU-4E23JBE (Shared Outdoor Unit) (共用室外組件)	-

The vendor undertakes that if lifts and appliances of the specified brand name or model number are not installed in the Development, lifts or appliances of comparable quality will be installed.  
賣方承諾如該發展項目中沒有安裝指明的品牌名稱或產品型號的升降機或設備，便會安裝品質相若的升降機或設備。

#### Notes:

- The residential floors start from 7/F in all towers of the Development.
- There is no Tower 4 in the Development.
- There are no 4/F, 13/F, 14/F, 24/F and 34/F in all towers of the Development.
- There are no 6/F and 19/F in Tower 1 and Tower 2 and no 20/F and 21/F in Tower 6, Tower 7, Tower 9 and Tower 10.
- There are no 2/F in Tower 3, Tower 5, Tower 6, Tower 7, Tower 8, Tower 9 and Tower 10.
- The symbol “-” as shown in the above table denotes “Not Provided”.
- The cells shaded in grey “■” as shown in the above table denotes “Not Applicable”.

#### 備註：

- 發展項目內所有座樓之住宅由7樓開始。
- 發展項目不設第4座。
- 發展項目內所有座樓均不設4樓、13樓、14樓、24樓及34樓。
- 第1座及第2座均不設6樓及19樓；第6座、第7座、第9座及第10座均不設20樓及21樓。
- 第3座、第5座、第6座、第7座、第8座、第9座及第10座均不設2樓。
- 上表內之“-”符號代表“沒有提供”。
- 上表內填上灰色“■”之部分代表“不適用”。

# FITTINGS, FINISHES AND APPLIANCES

## 裝置、裝修物料及設備

### Appliances Schedule 設備說明表

#### Tower 7 第7座

Location 位置	Appliances 設備	Brand Name 品牌名稱	22/F to 25/F 22樓至25樓		38/F to 39/F 38樓至39樓	38/F & 39/F 38樓及39樓	
			B	C	A	C	
Model Number 產品型號							
Ensuite Bedroom 套房	Split Type Air-Conditioner 分體式冷氣機	Panasonic	Indoor Unit 室內機		Indoor Unit 室內機	Indoor Unit 室內機	
					CS-E18JD4H	CS-E18JD4H	
			Outdoor Unit 室外機		Outdoor Unit 室外機	Outdoor Unit 室外機	
			CU-E18JBH	CU-E18JBH			
	Door Bell 門鐘	Hager 海格			-	XC001	
Kitchen 廚房	Split Type Air-Conditioner 分體式冷氣機	Panasonic	Indoor Unit 室內機		Indoor Unit 室內機	Indoor Unit 室內機	
			CS-E15HD3EA			CS-E15HD3EA	CS-E15HD3EA
			Outdoor Unit 室外機		Outdoor Unit 室外機	Outdoor Unit 室外機	
			CU-4E23JBE (Shared Outdoor Unit) (共用室外組件)			CU-4E23JBE (Shared Outdoor Unit) (共用室外組件)	CU-4E23JBE (Shared Outdoor Unit) (共用室外組件)

The vendor undertakes that if lifts and appliances of the specified brand name or model number are not installed in the Development, lifts or appliances of comparable quality will be installed.  
賣方承諾如該發展項目中沒有安裝指明的品牌名稱或產品型號的升降機或設備，便會安裝品質相若的升降機或設備。

#### Notes:

- The residential floors start from 7/F in all towers of the Development.
- There is no Tower 4 in the Development.
- There are no 4/F, 13/F, 14/F, 24/F and 34/F in all towers of the Development.
- There are no 6/F and 19/F in Tower 1 and Tower 2 and no 20/F and 21/F in Tower 6, Tower 7, Tower 9 and Tower 10.
- There are no 2/F in Tower 3, Tower 5, Tower 6, Tower 7, Tower 8, Tower 9 and Tower 10.
- The symbol “-” as shown in the above table denotes “Not Provided”.
- The cells shaded in grey “■” as shown in the above table denotes “Not Applicable”.

#### 備註：

- 發展項目內所有座樓之住宅由7樓開始。
- 發展項目不設第4座。
- 發展項目內所有座樓均不設4樓、13樓、14樓、24樓及34樓。
- 第1座及第2座均不設6樓及19樓；第6座、第7座、第9座及第10座均不設20樓及21樓。
- 第3座、第5座、第6座、第7座、第8座、第9座及第10座均不設2樓。
- 上表內之“-”符號代表“沒有提供”。
- 上表內填上灰色“■”之部分代表“不適用”。

# FITTINGS, FINISHES AND APPLIANCES

## 裝置、裝修物料及設備

### Appliances Schedule 設備說明表

#### Tower 7 第7座

Location 位置	Appliances 設備	Brand Name 品牌名稱	7/F 7樓			8/F to 19/F & 26/F to 37/F 8樓至19樓及26樓至37樓		
			A	B	C	A	B	C
			Model Number 產品型號					
Store 士多房	Split Type Air-Conditioner 分體式冷氣機	Panasonic	Indoor Unit 室內機			Indoor Unit 室內機		
			CS-E9JKEW	CS-E9JKEW	CS-RE9JKA	CS-E9JKEW	CS-E9JKEW	CS-RE9JKA
			Outdoor Unit 室外機			Outdoor Unit 室外機		
			CU-4E23JBE (Shared Outdoor Unit) (共用室外組件)	CU-4E23JBE (Shared Outdoor Unit) (共用室外組件)	CU-RE9JKA	CU-4E23JBE (Shared Outdoor Unit) (共用室外組件)	CU-4E23JBE (Shared Outdoor Unit) (共用室外組件)	CU-RE9JKA
Living Room, Dining Room & Corridor 客廳、飯廳及 走廊	Videophone 視像對講機	Bitron	AV2850/1	AV2850/1	AV2850/1	AV2850/1	AV2850/1	AV2850/1
	Door Bell 門鐘	Hager 海格	XC001	XC001	XC001	XC001	XC001	XC001

The vendor undertakes that if lifts and appliances of the specified brand name or model number are not installed in the Development, lifts or appliances of comparable quality will be installed.  
賣方承諾如該發展項目中沒有安裝指明的品牌名稱或產品型號的升降機或設備，便會安裝品質相若的升降機或設備。

#### Notes:

- The residential floors start from 7/F in all towers of the Development.
- There is no Tower 4 in the Development.
- There are no 4/F, 13/F, 14/F, 24/F and 34/F in all towers of the Development.
- There are no 6/F and 19/F in Tower 1 and Tower 2 and no 20/F and 21/F in Tower 6, Tower 7, Tower 9 and Tower 10.
- There are no 2/F in Tower 3, Tower 5, Tower 6, Tower 7, Tower 8, Tower 9 and Tower 10.
- The symbol “-” as shown in the above table denotes “Not Provided”.
- The cells shaded in grey “■” as shown in the above table denotes “Not Applicable”.

#### 備註：

- 發展項目內所有座樓之住宅由7樓開始。
- 發展項目不設第4座。
- 發展項目內所有座樓均不設4樓、13樓、14樓、24樓及34樓。
- 第1座及第2座均不設6樓及19樓；第6座、第7座、第9座及第10座均不設20樓及21樓。
- 第3座、第5座、第6座、第7座、第8座、第9座及第10座均不設2樓。
- 上表內之“-”符號代表“沒有提供”。
- 上表內填上灰色“■”之部分代表“不適用”。

# FITTINGS, FINISHES AND APPLIANCES

## 裝置、裝修物料及設備

### Appliances Schedule 設備說明表

#### Tower 7 第7座

Location 位置	Appliances 設備	Brand Name 品牌名稱	22/F to 25/F 22樓至25樓		38/F to 39/F 38樓至39樓	38/F & 39/F 38樓及39樓
			B	C	A	C
Model Number 產品型號						
Family Room 家庭室	Split Type Air-Conditioner 分體式冷氣機	Panasonic	Indoor Unit 室內機		Indoor Unit 室內機	Indoor Unit 室內機
						CS-E18JD4H
			Outdoor Unit 室外機		Outdoor Unit 室外機	Outdoor Unit 室外機
						CU-E18JBH
Store 士多房	Split Type Air-Conditioner 分體式冷氣機	Panasonic	Indoor Unit 室內機		Indoor Unit 室內機	Indoor Unit 室內機
			CS-E9JKEW	CS-RE9JKA	CS-E9JKEW	CS-E9JKEW
			Outdoor Unit 室外機		Outdoor Unit 室外機	Outdoor Unit 室外機
			CU-4E23JBE (Shared Outdoor Unit) (共用室外組件)	CU-RE9JKA	CU-4E23JBE (Shared Outdoor Unit) (共用室外組件)	CU-4E23JBE (Shared Outdoor Unit) (共用室外組件)
Living Room, Dining Room & Corridor 客廳、飯廳及 走廊	Videophone 視像對講機	Bitron	AV2850/1	AV2850/1	-	-
	Door Bell 門鐘	Hager 海格	XC001	XC001	XC001	-

The vendor undertakes that if lifts and appliances of the specified brand name or model number are not installed in the Development, lifts or appliances of comparable quality will be installed.  
賣方承諾如該發展項目中沒有安裝指明的品牌名稱或產品型號的升降機或設備，便會安裝品質相若的升降機或設備。

#### Notes:

- The residential floors start from 7/F in all towers of the Development.
- There is no Tower 4 in the Development.
- There are no 4/F, 13/F, 14/F, 24/F and 34/F in all towers of the Development.
- There are no 6/F and 19/F in Tower 1 and Tower 2 and no 20/F and 21/F in Tower 6, Tower 7, Tower 9 and Tower 10.
- There are no 2/F in Tower 3, Tower 5, Tower 6, Tower 7, Tower 8, Tower 9 and Tower 10.
- The symbol “-” as shown in the above table denotes “Not Provided”.
- The cells shaded in grey “■” as shown in the above table denotes “Not Applicable”.

#### 備註：

- 發展項目內所有座樓之住宅由7樓開始。
- 發展項目不設第4座。
- 發展項目內所有座樓均不設4樓、13樓、14樓、24樓及34樓。
- 第1座及第2座均不設6樓及19樓；第6座、第7座、第9座及第10座均不設20樓及21樓。
- 第3座、第5座、第6座、第7座、第8座、第9座及第10座均不設2樓。
- 上表內之“-”符號代表“沒有提供”。
- 上表內填上灰色“■”之部分代表“不適用”。



# FITTINGS, FINISHES AND APPLIANCES

## 裝置、裝修物料及設備

### Appliances Schedule 設備說明表

#### Tower 7 第7座

Location 位置	Appliances 設備	Brand Name 品牌名稱	7/F 7樓			8/F to 19/F & 26/F to 37/F 8樓至19樓及26樓至37樓		
			A	B	C	A	B	C
			Model Number 產品型號					
Kitchen 廚房	Cooker Hood 抽油煙機	Miele 美諾	DA3190	DA3190	DA3190	DA3190	DA3190	DA3190
	Gas Cooking Hob 煤氣煮食爐	Miele 美諾	CS1018G CS1013G	CS1018G CS1013G	CS1018G CS1013G	CS1018G CS1013G	CS1018G CS1013G	CS1018G CS1013G
	Gas Water Heater 煤氣熱水爐	TGC	NJW160TFQL <sup>(1)</sup>	NJW160TFQL <sup>(2)</sup>	NJW160TFQL <sup>(2)</sup>	NJW160TFQL <sup>(1)</sup>	NJW160TFQL <sup>(2)</sup>	NJW220TFQL <sup>(3)</sup>
	Microwave Oven 微波爐	Miele 美諾	M8161-2	M8161-2	M8161-2	M8161-2	M8161-2	M8161-2
	Refrigerator 雪櫃	Siemens 西門子	KI38VA/ KU15R	KI38VA/ KU15R	KI38VA	KI38VA/ KU15R	KI38VA/ KU15R	KI38VA
	Washer/Dryer 洗衣/乾衣機	Siemens 西門子	WK16D	WK16D	WK16D	WK16D	WK16D	WK16D
	Exhaust Fan 抽氣扇	Xpelair	GX 6	GX 6	GX 6	GX 6	GX 6	GX 6

The vendor undertakes that if lifts and appliances of the specified brand name or model number are not installed in the Development, lifts or appliances of comparable quality will be installed.  
賣方承諾如該發展項目中沒有安裝指明的品牌名稱或產品型號的升降機或設備，便會安裝品質相若的升降機或設備。

#### Notes:

- The residential floors start from 7/F in all towers of the Development.
- There is no Tower 4 in the Development.
- There are no 4/F, 13/F, 14/F, 24/F and 34/F in all towers of the Development.
- There are no 6/F and 19/F in Tower 1 and Tower 2 and no 20/F and 21/F in Tower 6, Tower 7, Tower 9 and Tower 10.
- There are no 2/F in Tower 3, Tower 5, Tower 6, Tower 7, Tower 8, Tower 9 and Tower 10.
- The symbol “-” as shown in the above table denotes “Not Provided”.
- The cells shaded in grey “■” as shown in the above table denotes “Not Applicable”.

(1) : The gas water heater located at A/C room & served for Lavatory leading from Kitchen, Kitchen and Bathroom

(2) : The gas water heater located at A/C room & served for Kitchen and Bathroom

(3) : The gas water heater located at A/C room & served for Lavatory leading from Kitchen and Bathroom next to Master Bedroom

#### 備註：

- 發展項目內所有座樓之住宅由7樓開始。
- 發展項目不設第4座。
- 發展項目內所有座樓均不設4樓、13樓、14樓、24樓及34樓。
- 第1座及第2座均不設6樓及19樓；第6座、第7座、第9座及第10座均不設20樓及21樓。
- 第3座、第5座、第6座、第7座、第8座、第9座及第10座均不設2樓。
- 上表內之“-”符號代表“沒有提供”。
- 上表內填上灰色“■”之部分代表“不適用”。

(1) : 該款煤氣熱水爐位於冷氣機房及供應熱水給由廚房通往之洗手間、廚房和浴室

(2) : 該款煤氣熱水爐位於冷氣機房及供應熱水給廚房和浴室

(3) : 該款煤氣熱水爐位於冷氣機房及供應熱水給由廚房通往之洗手間和主人房旁之浴室

# FITTINGS, FINISHES AND APPLIANCES

## 裝置、裝修物料及設備

### Appliances Schedule 設備說明表

#### Tower 7 第7座

Location 位置	Appliances 設備	Brand Name 品牌名稱	22/F to 25/F 22樓至25樓		38/F to 39/F 38樓至39樓	38/F & 39/F 38樓及39樓
			B	C	A	C
			Model Number 產品型號			
Kitchen 廚房	Cooker Hood 抽油煙機	Miele 美諾	DA3190	DA3190	DA422-4	DA422-4
	Gas Cooking Hob 煤氣煮食爐	Miele 美諾	CS1018G CS1013G	CS1018G CS1013G	CS1018G CS1013G	CS1018G CS1013G
	Gas Water Heater 煤氣熱水爐	TGC	NJW160TFQL <sup>(1)</sup>	NJW220TFQL <sup>(2)</sup>	NJW220TFQL <sup>(1)</sup>	NJW220TFQL <sup>(1)</sup>
	Microwave Oven 微波爐	Miele 美諾	M8161-2	M8161-2	M8161-2	M8161-2
	Refrigerator 雪櫃	Siemens 西門子	KI38VA/ KU15R	KI38VA	-	-
		Sub-Zero	-	-	ICBBI-42S	ICBBI-42S
	Washer/Dryer 洗衣/乾衣機	Miele 美諾	-	-	WT2789i	WT2789i
		Siemens 西門子	WK16D	WK16D	-	-
Exhaust Fan 抽氣扇	Xpelair	GX 6	GX 6	GX 6	GX 6	

The vendor undertakes that if lifts and appliances of the specified brand name or model number are not installed in the Development, lifts or appliances of comparable quality will be installed.  
賣方承諾如該發展項目中沒有安裝指明的品牌名稱或產品型號的升降機或設備，便會安裝品質相若的升降機或設備。

#### Notes:

- The residential floors start from 7/F in all towers of the Development.
  - There is no Tower 4 in the Development.
  - There are no 4/F, 13/F, 14/F, 24/F and 34/F in all towers of the Development.
  - There are no 6/F and 19/F in Tower 1 and Tower 2 and no 20/F and 21/F in Tower 6, Tower 7, Tower 9 and Tower 10.
  - There are no 2/F in Tower 3, Tower 5, Tower 6, Tower 7, Tower 8, Tower 9 and Tower 10.
  - The symbol “-” as shown in the above table denotes “Not Provided”.
  - The cells shaded in grey “■” as shown in the above table denotes “Not Applicable”.
- (1) : The gas water heater located at A/C room & served for Lavatory leading from Kitchen, Kitchen and Bathroom  
(2) : The gas water heater located at A/C room & served for Kitchen and Bathroom  
(3) : The gas water heater located at A/C room & served for Lavatory leading from Kitchen and Bathroom next to Master Bedroom

#### 備註:

- 發展項目內所有座樓之住宅由7樓開始。
  - 發展項目不設第4座。
  - 發展項目內所有座樓均不設4樓、13樓、14樓、24樓及34樓。
  - 第1座及第2座均不設6樓及19樓；第6座、第7座、第9座及第10座均不設20樓及21樓。
  - 第3座、第5座、第6座、第7座、第8座、第9座及第10座均不設2樓。
  - 上表內之“-”符號代表“沒有提供”。
  - 上表內填上灰色“■”之部分代表“不適用”。
- (1) : 該款煤氣熱水爐位於冷氣機房及供應熱水給由廚房通往之洗手間、廚房和浴室  
(2) : 該款煤氣熱水爐位於冷氣機房及供應熱水給廚房和浴室  
(3) : 該款煤氣熱水爐位於冷氣機房及供應熱水給由廚房通往之洗手間和主人房旁之浴室

# FITTINGS, FINISHES AND APPLIANCES

## 裝置、裝修物料及設備

### Appliances Schedule 設備說明表

#### Tower 7 第7座

Location 位置	Appliances 設備	Brand Name 品牌名稱	7/F 7樓			8/F to 19/F & 26/F to 37/F 8樓至19樓及26樓至37樓		
			A	B	C	A	B	C
			Model Number 產品型號					
Kitchen 廚房	Induction Hob 電磁爐	Miele 美諾	CS1212	CS1212	-	CS1212	CS1212	-
	Steam Oven 電蒸爐	Miele 美諾	DGC5051	DGC5051	DGC5051	DGC5051	DGC5051	DGC5051
	Wine Cellar 酒櫃	Miele 美諾	KWT4154UG-1	KWT4154UG-1	KWT4154UG-1	KWT4154UG-1	KWT4154UG-1	KWT4154UG-1
	Door Bell 門鐘	Hager 海格	XC001	XC001	XC001	XC001	XC001	XC001

The vendor undertakes that if lifts and appliances of the specified brand name or model number are not installed in the Development, lifts or appliances of comparable quality will be installed.  
賣方承諾如該發展項目中沒有安裝指明的品牌名稱或產品型號的升降機或設備，便會安裝品質相若的升降機或設備。

#### Notes:

- The residential floors start from 7/F in all towers of the Development.
- There is no Tower 4 in the Development.
- There are no 4/F, 13/F, 14/F, 24/F and 34/F in all towers of the Development.
- There are no 6/F and 19/F in Tower 1 and Tower 2 and no 20/F and 21/F in Tower 6, Tower 7, Tower 9 and Tower 10.
- There are no 2/F in Tower 3, Tower 5, Tower 6, Tower 7, Tower 8, Tower 9 and Tower 10.
- The symbol “-” as shown in the above table denotes “Not Provided”.
- The cells shaded in grey “■” as shown in the above table denotes “Not Applicable”.

#### 備註：

- 發展項目內所有座樓之住宅由7樓開始。
- 發展項目不設第4座。
- 發展項目內所有座樓均不設4樓、13樓、14樓、24樓及34樓。
- 第1座及第2座均不設6樓及19樓；第6座、第7座、第9座及第10座均不設20樓及21樓。
- 第3座、第5座、第6座、第7座、第8座、第9座及第10座均不設2樓。
- 上表內之“-”符號代表“沒有提供”。
- 上表內填上灰色“■”之部分代表“不適用”。

# FITTINGS, FINISHES AND APPLIANCES

## 裝置、裝修物料及設備

### Appliances Schedule 設備說明表

#### Tower 7 第7座

Location 位置	Appliances 設備	Brand Name 品牌名稱	22/F to 25/F 22樓至25樓		38/F to 39/F 38樓至39樓	38/F & 39/F 38樓及39樓
			B	C	A	C
			Model Number 產品型號			
Kitchen 廚房	Induction Hob 電磁爐	Miele 美諾	CS1212	-	CS1212	CS1212
	Steam Oven 電蒸爐	Miele 美諾	DGC5051	DGC5051	DGC5051	DGC5051
	Wine Cellar 酒櫃	Miele 美諾	KWT4154UG-1	KWT4154UG-1	KWT4154UG-1	KWT4154UG-1
	Door Bell 門鐘	Hager 海格	XC001	XC001	XC001	XC001
	Videophone 視像對講機	Bitron	-	-	AV2850/1	AV2850/1

The vendor undertakes that if lifts and appliances of the specified brand name or model number are not installed in the Development, lifts or appliances of comparable quality will be installed.  
賣方承諾如該發展項目中沒有安裝指明的品牌名稱或產品型號的升降機或設備，便會安裝品質相若的升降機或設備。

#### Notes:

- The residential floors start from 7/F in all towers of the Development.
- There is no Tower 4 in the Development.
- There are no 4/F, 13/F, 14/F, 24/F and 34/F in all towers of the Development.
- There are no 6/F and 19/F in Tower 1 and Tower 2 and no 20/F and 21/F in Tower 6, Tower 7, Tower 9 and Tower 10.
- There are no 2/F in Tower 3, Tower 5, Tower 6, Tower 7, Tower 8, Tower 9 and Tower 10.
- The symbol “-” as shown in the above table denotes “Not Provided”.
- The cells shaded in grey “■” as shown in the above table denotes “Not Applicable”.

#### 備註：

- 發展項目內所有座樓之住宅由7樓開始。
- 發展項目不設第4座。
- 發展項目內所有座樓均不設4樓、13樓、14樓、24樓及34樓。
- 第1座及第2座均不設6樓及19樓；第6座、第7座、第9座及第10座均不設20樓及21樓。
- 第3座、第5座、第6座、第7座、第8座、第9座及第10座均不設2樓。
- 上表內之“-”符號代表“沒有提供”。
- 上表內填上灰色“■”之部分代表“不適用”。

# FITTINGS, FINISHES AND APPLIANCES

## 裝置、裝修物料及設備

### Appliances Schedule 設備說明表

#### Tower 7 第7座

Location 位置	Appliances 設備	Brand Name 品牌名稱	7/F 7樓			8/F to 19/F & 26/F to 37/F 8樓至19樓及26樓至37樓		
			A	B	C	A	B	C
			Model Number 產品型號					
Bathroom in Master Bedroom 主人房內之浴室	10"LCD TV 10"液晶電視	JSA	TMBG10i	TMBG10i	-	TMBG10i	TMBG10i	-
	Gas Water Heater 煤氣熱水爐	TGC	NJW220TFQL	NJW220TFQL	NJW220TFQL	NJW220TFQL	NJW220TFQL	NJW220TFQL
	Exhaust Fan 抽氣扇	Ostberg 奧斯博格	RFE 140B	RFE 140B	GX 6	RFE 140B	RFE 140B	GX 6
Bathroom 浴室	Gas Water Heater 煤氣熱水爐	TGC	NJW160TFQL <sup>(1)</sup>	NJW160TFQL <sup>(2)</sup>	NJW160TFQL <sup>(2)</sup>	NJW160TFQL <sup>(1)</sup>	NJW160TFQL <sup>(2)</sup>	NJW160TFQL <sup>(2)</sup>
	Exhaust Fan 抽氣扇	Ostberg 奧斯博格	RFE 140A	RFE 140A	REF 140A	RFE 140A	RFE 140A	REF 140A

The vendor undertakes that if lifts and appliances of the specified brand name or model number are not installed in the Development, lifts or appliances of comparable quality will be installed.  
賣方承諾如該發展項目中沒有安裝指明的品牌名稱或產品型號的升降機或設備，便會安裝品質相若的升降機或設備。

#### Notes:

- The residential floors start from 7/F in all towers of the Development.
  - There is no Tower 4 in the Development.
  - There are no 4/F, 13/F, 14/F, 24/F and 34/F in all towers of the Development.
  - There are no 6/F and 19/F in Tower 1 and Tower 2 and no 20/F and 21/F in Tower 6, Tower 7, Tower 9 and Tower 10.
  - There are no 2/F in Tower 3, Tower 5, Tower 6, Tower 7, Tower 8, Tower 9 and Tower 10.
  - The symbol “-” as shown in the above table denotes “Not Provided”.
  - The cells shaded in grey “■” as shown in the above table denotes “Not Applicable”.
- (1) : The gas water heater located at A/C room & served for Lavatory leading from Kitchen, Kitchen and Bathroom  
(2) : The gas water heater located at A/C room & served for Kitchen and Bathroom  
(3) : The gas water heater located at A/C room & served for Lavatory leading from Kitchen and Bathroom next to Master Bedroom

#### 備註：

- 發展項目內所有座樓之住宅由7樓開始。
  - 發展項目不設第4座。
  - 發展項目內所有座樓均不設4樓、13樓、14樓、24樓及34樓。
  - 第1座及第2座均不設6樓及19樓；第6座、第7座、第9座及第10座均不設20樓及21樓。
  - 第3座、第5座、第6座、第7座、第8座、第9座及第10座均不設2樓。
  - 上表內之“-”符號代表“沒有提供”。
  - 上表內填上灰色“■”之部分代表“不適用”。
- (1) : 該款煤氣熱水爐位於冷氣機房及供應熱水給由廚房通往之洗手間、廚房和浴室  
(2) : 該款煤氣熱水爐位於冷氣機房及供應熱水給廚房和浴室  
(3) : 該款煤氣熱水爐位於冷氣機房及供應熱水給由廚房通往之洗手間和主人房旁之浴室

# FITTINGS, FINISHES AND APPLIANCES

## 裝置、裝修物料及設備

### Appliances Schedule 設備說明表

#### Tower 7 第7座

Location 位置	Appliances 設備	Brand Name 品牌名稱	22/F to 25/F 22樓至25樓		38/F to 39/F 38樓至39樓	38/F & 39/F 38樓及39樓
			B	C	A	C
			Model Number 產品型號			
Bathroom in Master Bedroom 主人房內之浴室	15"LCD TV 15"液晶電視	JSA	-	-	TMBG15	TMBG15
	10"LCD TV 10"液晶電視	JSA	TMBG10i	-	-	-
	Ceiling Speaker 揚聲器	KEF	-	-	2 x Cs130.2FS	2 x Cs130.2FS
	Gas Water Heater 煤氣熱水爐	TGC	NJW220TFQL	NJW220TFQL	NJW220TFQL	NJW220TFQL
	Exhaust Fan 抽氣扇	Ostberg 奧斯博格	RFE 140B	GX 6	RFE 200B	RFE 200B
Bathroom 浴室	Gas Water Heater 煤氣熱水爐	TGC	NJW160TFQL <sup>(2)</sup>	NJW160TFQL <sup>(2)</sup>	NJW220TFQL <sup>(1)</sup>	NJW220TFQL <sup>(1)</sup>
	Exhaust Fan 抽氣扇	Ostberg 奧斯博格	RFE 140A	REF 140A	RFE 140A	RFE 140A

The vendor undertakes that if lifts and appliances of the specified brand name or model number are not installed in the Development, lifts or appliances of comparable quality will be installed.  
賣方承諾如該發展項目中沒有安裝指明的品牌名稱或產品型號的升降機或設備，便會安裝品質相若的升降機或設備。

#### Notes:

- The residential floors start from 7/F in all towers of the Development.
  - There is no Tower 4 in the Development.
  - There are no 4/F, 13/F, 14/F, 24/F and 34/F in all towers of the Development.
  - There are no 6/F and 19/F in Tower 1 and Tower 2 and no 20/F and 21/F in Tower 6, Tower 7, Tower 9 and Tower 10.
  - There are no 2/F in Tower 3, Tower 5, Tower 6, Tower 7, Tower 8, Tower 9 and Tower 10.
  - The symbol "-" as shown in the above table denotes "Not Provided".
  - The cells shaded in grey "■" as shown in the above table denotes "Not Applicable".
- (1): The gas water heater located at A/C room & served for Lavatory leading from Kitchen, Kitchen and Bathroom  
(2): The gas water heater located at A/C room & served for Kitchen and Bathroom  
(3): The gas water heater located at A/C room & served for Lavatory leading from Kitchen and Bathroom next to Master Bedroom

#### 備註:

- 發展項目內所有座樓之住宅由7樓開始。
  - 發展項目不設第4座。
  - 發展項目內所有座樓均不設4樓、13樓、14樓、24樓及34樓。
  - 第1座及第2座均不設6樓及19樓；第6座、第7座、第9座及第10座均不設20樓及21樓。
  - 第3座、第5座、第6座、第7座、第8座、第9座及第10座均不設2樓。
  - 上表內之“-”符號代表“沒有提供”。
  - 上表內填上灰色“■”之部分代表“不適用”。
- (1): 該款煤氣熱水爐位於冷氣機房及供應熱水給由廚房通往之洗手間、廚房和浴室  
(2): 該款煤氣熱水爐位於冷氣機房及供應熱水給廚房和浴室  
(3): 該款煤氣熱水爐位於冷氣機房及供應熱水給由廚房通往之洗手間和主人房旁之浴室

# FITTINGS, FINISHES AND APPLIANCES

## 裝置、裝修物料及設備

### Appliances Schedule 設備說明表

#### Tower 7 第7座

Location 位置	Appliances 設備	Brand Name 品牌名稱	7/F 7樓			8/F to 19/F & 26/F to 37/F 8樓至19樓及26樓至37樓		
			A	B	C	A	B	C
			Model Number 產品型號					
Bathroom next to Master Bedroom 主人房旁之浴室	Gas Water Heater 煤氣熱水爐	TGC		NJW160TFQL <sup>(3)</sup>			NJW160TFQL <sup>(3)</sup>	
	Exhaust Fan 抽氣扇	Ostberg 奧斯博格		RFE 140A			RFE 140A	
Lavatory leading from Kitchen 由廚房通往之 洗手間	Gas Water Heater 煤氣熱水爐	TGC	NJW160TFQL <sup>(1)</sup>	NJW160TFQL <sup>(3)</sup>		NJW160TFQL <sup>(1)</sup>	NJW160TFQL <sup>(3)</sup>	
	Exhaust Fan 抽氣扇	Xpelair	GX 6	GX 6		GX 6	GX 6	

The vendor undertakes that if lifts and appliances of the specified brand name or model number are not installed in the Development, lifts or appliances of comparable quality will be installed.  
賣方承諾如該發展項目中沒有安裝指明的品牌名稱或產品型號的升降機或設備，便會安裝品質相若的升降機或設備。

#### Notes:

- The residential floors start from 7/F in all towers of the Development.
  - There is no Tower 4 in the Development.
  - There are no 4/F, 13/F, 14/F, 24/F and 34/F in all towers of the Development.
  - There are no 6/F and 19/F in Tower 1 and Tower 2 and no 20/F and 21/F in Tower 6, Tower 7, Tower 9 and Tower 10.
  - There are no 2/F in Tower 3, Tower 5, Tower 6, Tower 7, Tower 8, Tower 9 and Tower 10.
  - The symbol “-” as shown in the above table denotes “Not Provided”.
  - The cells shaded in grey “■” as shown in the above table denotes “Not Applicable”.
- (1) : The gas water heater located at A/C room & served for Lavatory leading from Kitchen, Kitchen and Bathroom  
(2) : The gas water heater located at A/C room & served for Kitchen and Bathroom  
(3) : The gas water heater located at A/C room & served for Lavatory leading from Kitchen and Bathroom next to Master Bedroom

#### 備註：

- 發展項目內所有座樓之住宅由7樓開始。
  - 發展項目不設第4座。
  - 發展項目內所有座樓均不設4樓、13樓、14樓、24樓及34樓。
  - 第1座及第2座均不設6樓及19樓；第6座、第7座、第9座及第10座均不設20樓及21樓。
  - 第3座、第5座、第6座、第7座、第8座、第9座及第10座均不設2樓。
  - 上表內之“-”符號代表“沒有提供”。
  - 上表內填上灰色“■”之部分代表“不適用”。
- (1) : 該款煤氣熱水爐位於冷氣機房及供應熱水給由廚房通往之洗手間、廚房和浴室  
(2) : 該款煤氣熱水爐位於冷氣機房及供應熱水給廚房和浴室  
(3) : 該款煤氣熱水爐位於冷氣機房及供應熱水給由廚房通往之洗手間和主人房旁之浴室

# FITTINGS, FINISHES AND APPLIANCES

## 裝置、裝修物料及設備

### Appliances Schedule 設備說明表

#### Tower 7 第7座

Location 位置	Appliances 設備	Brand Name 品牌名稱	22/F to 25/F 22樓至25樓		38/F to 39/F 38樓至39樓	38/F & 39/F 38樓及39樓
			B	C	A	C
			Model Number 產品型號			
Bathroom next to Master Bedroom 主人房旁之浴室	Gas Water Heater 煤氣熱水爐	TGC	NJW160TFQL <sup>(3)</sup>			
	Exhaust Fan 抽氣扇	Ostberg 奧斯博格	RFE 140A			
Bathroom in Ensuite Bedroom 套房內之浴室	Gas Water Heater 煤氣熱水爐	TGC			NJW220TFQL <sup>(4)</sup>	NJW220TFQL
	Exhaust Fan 抽氣扇	Ostberg 奧斯博格			RFE 140A	RFE 140A
Lavatory near to Living Room 鄰近客廳之 洗手間	Gas Water Heater 煤氣熱水爐	TGC			NJW220TFQL <sup>(4)</sup>	
	Exhaust Fan 抽氣扇	Ostberg 奧斯博格			RFE-140A	
Lavatory leading from Kitchen 由廚房通往之 洗手間	Gas Water Heater 煤氣熱水爐	TGC	NJW160TFQL <sup>(3)</sup>		NJW220TFQL <sup>(1)</sup>	NJW220TFQL <sup>(1)</sup>
	Exhaust Fan 抽氣扇	Xpelair	GX 6		GX 6	-
		Ostberg 奧斯博格	-		-	RFE 140A

The vendor undertakes that if lifts and appliances of the specified brand name or model number are not installed in the Development, lifts or appliances of comparable quality will be installed.  
賣方承諾如該發展項目中沒有安裝指明的品牌名稱或產品型號的升降機或設備，便會安裝品質相若的升降機或設備。

#### Notes:

- There is no Tower 4 in the Development.
  - There are no 4/F, 13/F, 14/F, 24/F and 34/F in all towers of the Development.
  - There are no 6/F and 19/F in Tower 1 and Tower 2 and no 20/F and 21/F in Tower 6, Tower 7, Tower 9 and Tower 10.
  - The symbol “-” as shown in the above table denotes “Not Provided”.
  - The cells shaded in grey “■” as shown in the above table denotes “Not Applicable”.
- (1): The gas water heater located at A/C room & served for Lavatory leading from Kitchen, Kitchen and Bathroom  
(2): The gas water heater located at A/C room & served for Kitchen and Bathroom  
(3): The gas water heater located at A/C room & served for Lavatory leading from Kitchen and Bathroom next to Master Bedroom  
(4): The gas water heater located at A/C room & served for Lavatory near to Living Room and Bathroom in Ensuite Bedroom

#### 備註:

- 發展項目不設第4座。
  - 發展項目內所有座樓均不設4樓、13樓、14樓、24樓及34樓。
  - 第1座及第2座均不設6樓及19樓；第6座、第7座、第9座及第10座均不設20樓及21樓。
  - 上表內之“-”符號代表“沒有提供”。
  - 上表內填上灰色“■”之部分代表“不適用”。
- (1): 該款煤氣熱水爐位於冷氣機房及供應熱水給由廚房通往之洗手間，廚房和浴室  
(2): 該款煤氣熱水爐位於冷氣機房及供應熱水給廚房和浴室  
(3): 該款煤氣熱水爐位於冷氣機房及供應熱水給由廚房通往之洗手間和主人房旁之浴室  
(4): 該款煤氣熱水爐位於冷氣機房及供應熱水給鄰近客廳之洗手間和套房內之浴室



# FITTINGS, FINISHES AND APPLIANCES

## 裝置、裝修物料及設備

### Schedule of Mechanical and Electrical Provisions 機電裝置數量說明表

#### Tower 7 第7座

Location 位置	Exposed Type 外露型	Non-Exposed Type 非外露型	7/F 7樓			8/F to 19/F & 26/F to 37/F 8樓至19樓及26樓至37樓			22/F to 25/F 22樓至25樓		38/F 38樓		39/F 39樓	
			A	B	C	A	B	C	B	C	A	C	A	C
Living Room, Dining Room & Corridor 客廳、飯廳及 走廊	TV/ FM Outlet 電視/電台天線插座		3	3	2	3	3	2	3	2	2	2	2	
	Telephone Outlet 電話插座		2	2	1	2	2	2	2	2	2	2	2	
	13A Twin Socket Outlet 13A雙位電插座		5	6	4	6	6	5	6	5	4	4	4	
	13A Single Socket Outlet 13A單位電插座		5	4	4	3	3	3	3	3	6	4	6	
	Lighting Switch 燈掣		7	8	7	6	7	7	7	7	9	3	8	
		Door Bell 門鐘		1	1	1	1	1	1	1	1	-	1	
		Door Phone Handset 對講機		1	1	1	1	1	1	1	1	-	-	-
		20A Double Pole Switch with Pilot Lamp 20A 雙極開關掣		2	3	2	2	3	2	3	2	2	1	2
	Fused Spur Unit/Connection Unit 接線座		1	1	1	1	1	1	1	1	1	-	1	
Master Bedroom 主人房	TV/ FM Outlet 電視/電台天線插座		2	3	1	2	3	1	3	1	2		2	2
	Telephone Outlet 電話插座		2	3	2	2	3	1	3	1	2		2	2
	13A Twin Socket Outlet 13A雙位電插座		3	5	4	3	5	3	5	3	6		6	4
	13A Single Socket Outlet 13A單位電插座		2	2	-	2	2	1	2	1	-		-	2
	Lighting Switch 燈掣		4	6	2	4	5	2	5	2	3		3	3
	20A Double Pole Switch with Pilot Lamp 20A 雙極開關掣		1	2	1	1	1	1	1	1	2		2	2

#### Notes:

- The residential floors start from 7/F in all towers of the Development.
- There is no Tower 4 in the Development.
- There are no 4/F, 13/F, 14/F, 24/F and 34/F in all towers of the Development.
- There are no 6/F and 19/F in Tower 1 and Tower 2 and no 20/F and 21/F in Tower 6, Tower 7, Tower 9 and Tower 10.
- There are no 2/F in Tower 3, Tower 5, Tower 6, Tower 7, Tower 8, Tower 9 and Tower 10.
- The symbol “-” as shown in the above table denotes “Not Provided”.
- The cells shaded in grey “■” as shown in the above table denotes “Not Applicable”.

#### 備註:

- 發展項目內所有座樓之住宅由7樓開始。
- 發展項目不設第4座。
- 發展項目內所有座樓均不設4樓、13樓、14樓、24樓及34樓。
- 第1座及第2座均不設6樓及19樓；第6座、第7座、第9座及第10座均不設20樓及21樓。
- 第3座、第5座、第6座、第7座、第8座、第9座及第10座均不設2樓。
- 上表內之“-”符號代表“沒有提供”。
- 上表內填上灰色“■”之部分代表“不適用”。

# FITTINGS, FINISHES AND APPLIANCES

## 裝置、裝修物料及設備

### Schedule of Mechanical and Electrical Provisions 機電裝置數量說明表

#### Tower 7 第7座

Location 位置	Exposed Type 外露型	Non-Exposed Type 非外露型	7/F 7樓			8/F to 19/F & 26/F to 37/F 8樓至19樓及26樓至37樓			22/F to 25/F 22樓至25樓		38/F 38樓		39/F 39樓	
			A	B	C	A	B	C	B	C	A	C	A	C
Bedroom 1 睡房1	TV/ FM Outlet 電視/電台天線插座				1			1		1	2	2	2	
	Telephone Outlet 電話插座			1			1		1	2	1	2		
	13A Twin Socket Outlet 13A雙位電插座			2			1		1	2	3	2		
	13A Single Socket Outlet 13A單位電插座			-			1		1	-	1	-		
	Lighting Switch 燈掣			1			1		1	2	2	2		
Bedroom 2 睡房2	TV/ FM Outlet 電視/電台天線插座			1			1		1					
	Telephone Outlet 電話插座			1			1		1					
	13A Twin Socket Outlet 13A雙位電插座			2			1		1					
	13A Single Socket Outlet 13A單位電插座			-			1		1					
	Lighting Switch 燈掣			1			1		1					

#### Notes:

- The residential floors start from 7/F in all towers of the Development.
- There is no Tower 4 in the Development.
- There are no 4/F, 13/F, 14/F, 24/F and 34/F in all towers of the Development.
- There are no 6/F and 19/F in Tower 1 and Tower 2 and no 20/F and 21/F in Tower 6, Tower 7, Tower 9 and Tower 10.
- There are no 2/F in Tower 3, Tower 5, Tower 6, Tower 7, Tower 8, Tower 9 and Tower 10.
- The symbol “-” as shown in the above table denotes “Not Provided”.
- The cells shaded in grey “■” as shown in the above table denotes “Not Applicable”.

#### 備註：

- 發展項目內所有座樓之住宅由7樓開始。
- 發展項目不設第4座。
- 發展項目內所有座樓均不設4樓、13樓、14樓、24樓及34樓。
- 第1座及第2座均不設6樓及19樓；第6座、第7座、第9座及第10座均不設20樓及21樓。
- 第3座、第5座、第6座、第7座、第8座、第9座及第10座均不設2樓。
- 上表內之“-”符號代表“沒有提供”。
- 上表內填上灰色“■”之部分代表“不適用”。

# FITTINGS, FINISHES AND APPLIANCES

## 裝置、裝修物料及設備

Schedule of Mechanical and Electrical Provisions  
機電裝置數量說明表

### Tower 7 第7座

Location 位置	Exposed Type 外露型	Non-Exposed Type 非外露型	7/F 7樓			8/F to 19/F & 26/F to 37/F 8樓至19樓及26樓至37樓			22/F to 25/F 22樓至25樓		38/F 38樓		39/F 39樓		
			A	B	C	A	B	C	B	C	A	C	A	C	
Ensuite Bedroom 套房	TV/ FM Outlet 電視/電台天線插座										2		2	2	
	Telephone Outlet 電話插座										1		1	1	
	13A Twin Socket Outlet 13A雙位電插座										1		2	3	
	13A Single Socket Outlet 13A單位電插座										3		2	1	
	Lighting Switch 燈掣										4		3	3	
		Door Bell 門鐘										-		-	1
		20A Double Pole Switch with Pilot Lamp 20A 雙極開關掣										1		1	1
		Fused Spur Unit/Connection Unit 接線座										-		-	1
Family Room 家庭室	TV/ FM Outlet 電視/電台天線插座													2	
	Telephone Outlet 電話插座													2	
	13A Twin Socket Outlet 13A雙位電插座													4	
	13A Single Socket Outlet 13A單位電插座													1	
	Lighting Switch 燈掣													1	

Notes:

- The residential floors start from 7/F in all towers of the Development.
- There is no Tower 4 in the Development.
- There are no 4/F, 13/F, 14/F, 24/F and 34/F in all towers of the Development.
- There are no 6/F and 19/F in Tower 1 and Tower 2 and no 20/F and 21/F in Tower 6, Tower 7, Tower 9 and Tower 10.
- There are no 2/F in Tower 3, Tower 5, Tower 6, Tower 7, Tower 8, Tower 9 and Tower 10.
- The symbol “-” as shown in the above table denotes “Not Provided”.
- The cells shaded in grey “■” as shown in the above table denotes “Not Applicable”.

備註：

- 發展項目內所有座樓之住宅由7樓開始。
- 發展項目不設第4座。
- 發展項目內所有座樓均不設4樓、13樓、14樓、24樓及34樓。
- 第1座及第2座均不設6樓及19樓；第6座、第7座、第9座及第10座均不設20樓及21樓。
- 第3座、第5座、第6座、第7座、第8座、第9座及第10座均不設2樓。
- 上表內之“-”符號代表“沒有提供”。
- 上表內填上灰色“■”之部分代表“不適用”。

# FITTINGS, FINISHES AND APPLIANCES

## 裝置、裝修物料及設備

### Schedule of Mechanical and Electrical Provisions

#### 機電裝置數量說明表

#### Tower 7 第7座

Location 位置	Exposed Type 外露型	Non-Exposed Type 非外露型	7/F 7樓			8/F to 19/F & 26/F to 37/F 8樓至19樓及26樓至37樓			22/F to 25/F 22樓至25樓		38/F 38樓		39/F 39樓	
			A	B	C	A	B	C	B	C	A	C	A	C
Store 士多房	TV/ FM Outlet 電視/電台天線插座		1	1	1	1	1	1	1	1	1	1	1	
	Telephone Outlet 電話插座		-	-	-	-	-	-	-	-	1	1	1	
	13A Twin Socket Outlet 13A雙位電插座		1	1	1	1	1	1	1	1	1	-	1	
	13A Single Socket Outlet 13A單位電插座		-	-	-	-	-	-	-	-	-	1	-	
	Lighting Switch 燈掣		1	1	1	1	1	1	1	1	1	2	1	
20A Double Pole Switch with Pilot Lamp 20A 雙極開關掣		2	1	-	1	1	-	1	-	1	1	1		
Bathroom in Master Bedroom 主人房內之浴室	TV / FM Outlet 電視/電台天線插座		1	1	1	1	1	1	1	1	1		1	1
	13A Single Socket Outlet 13A單位電插座		2	2	2	2	2	2	2	2	3		3	3
	Fused Spur Unit/Connection Unit接線座		1	1	1	1	1	1	1	1	1		1	1
Bathroom in Ensuite Bedroom 套房內之浴室	13A Single Socket Outlet 13A單位電插座										1		1	1
	Fused Spur Unit/Connection Unit接線座										1		1	1
Bathroom 浴室	13A Single Socket Outlet 13A單位電插座		1	1	1	1	1	1	1	1	1	1	1	
	Fused Spur Unit/Connection Unit接線座		1	1	1	1	1	1	1	1	1	1	1	
Bathroom next to Master Bedroom 主人房旁之浴室	13A Single Socket Outlet 13A單位電插座			1			1		1					
	Fused Spur Unit/Connection Unit接線座			1			1		1					

#### Notes:

- The residential floors start from 7/F in all towers of the Development.
- There is no Tower 4 in the Development.
- There are no 4/F, 13/F, 14/F, 24/F and 34/F in all towers of the Development.
- There are no 6/F and 19/F in Tower 1 and Tower 2 and no 20/F and 21/F in Tower 6, Tower 7, Tower 9 and Tower 10.
- There are no 2/F in Tower 3, Tower 5, Tower 6, Tower 7, Tower 8, Tower 9 and Tower 10.
- The symbol “-” as shown in the above table denotes “Not Provided”.
- The cells shaded in grey “■” as shown in the above table denotes “Not Applicable”.

#### 備註:

- 發展項目內所有座樓之住宅由7樓開始。
- 發展項目不設第4座。
- 發展項目內所有座樓均不設4樓、13樓、14樓、24樓及34樓。
- 第1座及第2座均不設6樓及19樓；第6座、第7座、第9座及第10座均不設20樓及21樓。
- 第3座、第5座、第6座、第7座、第8座、第9座及第10座均不設2樓。
- 上表內之“-”符號代表“沒有提供”。
- 上表內填上灰色“■”之部分代表“不適用”。

# FITTINGS, FINISHES AND APPLIANCES

## 裝置、裝修物料及設備

### Schedule of Mechanical and Electrical Provisions 機電裝置數量說明表

#### Tower 7 第7座

Location 位置	Exposed Type 外露型	Non-Exposed Type 非外露型	7/F 7樓			8/F to 19/F & 26/F to 37/F 8樓至19樓及26樓至37樓			22/F to 25/F 22樓至25樓		38/F 38樓		39/F 39樓	
			A	B	C	A	B	C	B	C	A	C	A	C
Lavatory near to Living Room 鄰近客廳之 洗手間	13A Single Socket Outlet 13A單位電插座										1		1	
		Fused Spur Unit/Connection Unit 接線座									1		1	
Lavatory leading from Kitchen 由廚房通往之 洗手間		Fused Spur Unit/Connection Unit 接線座	1	1		1	1		1		1	1	1	
Kitchen 廚房	13A Twin Socket Outlet 13A雙位電插座		1	1	1	1	1	1	1	1	2	3	2	
		13A Twin Socket Outlet 13A雙位電插座	1	1	1	1	1	1	1	1	-	-	-	
		13A Single Socket Outlet 13A 單位電插座	7	7	6	7	7	6	7	6	7	7	7	
		Lighting Switch 燈掣	-	-	-	-	-	-	-	-	1	-	1	
		Door Bell 門鐘	1	1	1	1	1	1	1	1	1	1	1	
		Door Phone Handset 對講機	-	-	-	-	-	-	-	-	1	1	1	
		20A Double Pole Switch with Pilot Lamp 20A 雙極開關掣	1	1	1	1	1	1	1	1	2	1	2	
		Fused Spur Unit/Connection Unit 接線座	3	3	1	3	3	1	3	1	3	3	3	
		Drain Point For Washing Machine 去水位供洗衣機	1	1	1	1	1	1	1	1	1	1	1	
	Water Point For Washing Machine 來水位供洗衣機	1	1	1	1	1	1	1	1	1	1	1		

#### Notes:

- The residential floors start from 7/F in all towers of the Development.
- There is no Tower 4 in the Development.
- There are no 4/F, 13/F, 14/F, 24/F and 34/F in all towers of the Development.
- There are no 6/F and 19/F in Tower 1 and Tower 2 and no 20/F and 21/F in Tower 6, Tower 7, Tower 9 and Tower 10.
- There are no 2/F in Tower 3, Tower 5, Tower 6, Tower 7, Tower 8, Tower 9 and Tower 10.
- The symbol “-” as shown in the above table denotes “Not Provided”.
- The cells shaded in grey “■” as shown in the above table denotes “Not Applicable”.

#### 備註：

- 發展項目內所有座樓之住宅由7樓開始。
- 發展項目不設第4座。
- 發展項目內所有座樓均不設4樓、13樓、14樓、24樓及34樓。
- 第1座及第2座均不設6樓及19樓；第6座、第7座、第9座及第10座均不設20樓及21樓。
- 第3座、第5座、第6座、第7座、第8座、第9座及第10座均不設2樓。
- 上表內之“-”符號代表“沒有提供”。
- 上表內填上灰色“■”之部分代表“不適用”。

# FITTINGS, FINISHES AND APPLIANCES

## 裝置、裝修物料及設備

### Schedule of Mechanical and Electrical Provisions 機電裝置數量說明表

#### Tower 7 第7座

Location 位置	Exposed Type 外露型	Non-Exposed Type 非外露型	7/F 7樓			8/F to 19/F & 26/F to 37/F 8樓至19樓及26樓至37樓			22/F to 25/F 22樓至25樓		38/F 38樓		39/F 39樓	
			A	B	C	A	B	C	B	C	A	C	A	C
Stairhood 梯屋	Lighting Switch 燈掣												2	2
Flat Roof 平台	13A Weather Proof Single / Twin Socket Outlet 13A 防水單位/雙位電插座		2	2	1	- <sup>(#)</sup>					1			
Roof 天台	13A Weather Proof Single / Twin Socket Outlet 13A 防水單位/雙位電插座												1	1

#### Notes:

- The residential floors start from 7/F in all towers of the Development.
- There is no Tower 4 in the Development.
- There are no 4/F, 13/F, 14/F, 24/F and 34/F in all towers of the Development.
- There are no 6/F and 19/F in Tower 1 and Tower 2 and no 20/F and 21/F in Tower 6, Tower 7, Tower 9 and Tower 10.
- There are no 2/F in Tower 3, Tower 5, Tower 6, Tower 7, Tower 8, Tower 9 and Tower 10.
- The symbol “-” as shown in the above table denotes “Not Provided”.
- The cells shaded in grey “■” as shown in the above table denotes “Not Applicable”.
- The provision mark with “#” only apply to Flat A of 10/F. There is no Flat Roof for other floors.

#### 備註：

- 發展項目內所有座樓之住宅由7樓開始。
- 發展項目不設第4座。
- 發展項目內所有座樓均不設4樓、13樓、14樓、24樓及34樓。
- 第1座及第2座均不設6樓及19樓；第6座、第7座、第9座及第10座均不設20樓及21樓。
- 第3座、第5座、第6座、第7座、第8座、第9座及第10座均不設2樓。
- 上表內之“-”符號代表“沒有提供”。
- 上表內填上灰色“■”之部分代表“不適用”。
- 註有“#”的數量只適用於10樓A單位，其餘樓層並沒有平台。

# FITTINGS, FINISHES AND APPLIANCES

## 裝置、裝修物料及設備

### Appliances Schedule 設備說明表

#### Tower 8 第8座

Location 位置	Appliances 設備	Brand Name 品牌名稱	7/F 7樓				8/F to 36/F 8樓至36樓			
			A	B	C	D	A	B	C	D
			Model Number 產品型號							
Living Room, Dining Room & Corridor 客廳、飯廳 及走廊	Split Type Air-Conditioner 分體式冷氣機	Panasonic	Indoor Unit 室內機				Indoor Unit 室內機			
			CS- E18JD4H(2NOS.)/ CS-E10HD3EA	CS- E18JD4H(2NOS.)/ CS-E10HD3EA	CS-E23JD4H	CS-E23JD4H	CS- E18JD4H(2NOS.)/ CS-E10HD3EA	CS- E18JD4H(2NOS.)/ CS-E10HD3EA	CS-E23JD4H	CS-E23JD4H
			Outdoor Unit 室外機				Outdoor Unit 室外機			
			CU- E18JBH(2NOS.)/ CU-2E18CBPGW (Shared Outdoor Unit) (共用室外組件)	CU- E18JBH(2NOS.)/ CU-2E18CBPGW (Shared Outdoor Unit) (共用室外組件)	CU-E23JBH	CU-E23JBH	CU- E18JBH(2NOS.)/ CU-2E18CBPGW (Shared Outdoor Unit) (共用室外組件)	CU- E18JBH(2NOS.)/ CU-2E18CBPGW (Shared Outdoor Unit) (共用室外組件)	CU-E23JBH	CU-E23JBH

The vendor undertakes that if lifts and appliances of the specified brand name or model number are not installed in the Development, lifts or appliances of comparable quality will be installed.  
賣方承諾如該發展項目中沒有安裝指明的品牌名稱或產品型號的升降機或設備，便會安裝品質相若的升降機或設備。

#### Notes:

- The residential floors start from 7/F in all towers of the Development.
- There is no Tower 4 in the Development.
- There are no 4/F, 13/F, 14/F, 24/F and 34/F in all towers of the Development.
- There are no 6/F and 19/F in Tower 1 and Tower 2 and no 20/F and 21/F in Tower 6, Tower 7, Tower 9 and Tower 10.
- There are no 2/F in Tower 3, Tower 5, Tower 6, Tower 7, Tower 8, Tower 9 and Tower 10.
- The symbol “-” as shown in the above table denotes “Not Provided”.
- The cells shaded in grey “■” as shown in the above table denotes “Not Applicable”.

#### 備註：

- 發展項目內所有座樓之住宅由7樓開始。
- 發展項目不設第4座。
- 發展項目內所有座樓均不設4樓、13樓、14樓、24樓及34樓。
- 第1座及第2座均不設6樓及19樓；第6座、第7座、第9座及第10座均不設20樓及21樓。
- 第3座、第5座、第6座、第7座、第8座、第9座及第10座均不設2樓。
- 上表內之“-”符號代表“沒有提供”。
- 上表內填上灰色“■”之部分代表“不適用”。

# FITTINGS, FINISHES AND APPLIANCES

## 裝置、裝修物料及設備

### Appliances Schedule 設備說明表

#### Tower 8 第8座

Location 位置	Appliances 設備	Brand Name 品牌名稱	37/F to 38/F 37樓至38樓		
			A	C	D
			Model Number 產品型號		
Living Room, Dining Room & Corridor 客廳、飯廳 及走廊	Split Type Air-Conditioner 分體式冷氣機	Panasonic	Indoor Unit 室內機		
			CS-E18JD4H(3NOS)	CS-E23JD4H	CS-E23JD4H
			Outdoor Unit 室外機		
			CU-E18JBH(3NOS.)	CU-E23JBH	CU-E23JBH

The vendor undertakes that if lifts and appliances of the specified brand name or model number are not installed in the Development, lifts or appliances of comparable quality will be installed.  
賣方承諾如該發展項目中沒有安裝指明的品牌名稱或產品型號的升降機或設備，便會安裝品質相若的升降機或設備。

#### Notes:

- The residential floors start from 7/F in all towers of the Development.
- There is no Tower 4 in the Development.
- There are no 4/F, 13/F, 14/F, 24/F and 34/F in all towers of the Development.
- There are no 6/F and 19/F in Tower 1 and Tower 2 and no 20/F and 21/F in Tower 6, Tower 7, Tower 9 and Tower 10.
- There are no 2/F in Tower 3, Tower 5, Tower 6, Tower 7, Tower 8, Tower 9 and Tower 10.
- The symbol “-” as shown in the above table denotes “Not Provided”.
- The cells shaded in grey “■” as shown in the above table denotes “Not Applicable”.

#### 備註：

- 發展項目內所有座樓之住宅由7樓開始。
- 發展項目不設第4座。
- 發展項目內所有座樓均不設4樓、13樓、14樓、24樓及34樓。
- 第1座及第2座均不設6樓及19樓；第6座、第7座、第9座及第10座均不設20樓及21樓。
- 第3座、第5座、第6座、第7座、第8座、第9座及第10座均不設2樓。
- 上表內之“-”符號代表“沒有提供”。
- 上表內填上灰色“■”之部分代表“不適用”。



# FITTINGS, FINISHES AND APPLIANCES

## 裝置、裝修物料及設備

### Appliances Schedule 設備說明表

#### Tower 8 第8座

Location 位置	Appliances 設備	Brand Name 品牌名稱	7/F 7樓				8/F to 36/F 8樓至36樓			
			A	B	C	D	A	B	C	D
			Model Number 產品型號							
Master Bedroom 主人房	Split Type Air-Conditioner 分體式冷氣機	Panasonic	Indoor Unit 室內機				Indoor Unit 室內機			
			CS-E18JD4H/ CS-E10HD3EA	CS-E18JD4H/ CS-E10HD3EA	CU-E15HD3EA	CU-E15HD3EA	CS-E18JD4H/ CS-E10HD3EA	CS-E18JD4H/ CS-E10HD3EA	CU-E15HD3EA	CU-E15HD3EA
			Outdoor Unit 室外機				Outdoor Unit 室外機			
			CU-E18JBH/ CU-2E18CBPGW (Shared Outdoor Unit) (共用室外組件)	CU-E18JBH/ CU-2E18CBPGW (Shared Outdoor Unit) (共用室外組件)	CU-4E23JBE (Shared Outdoor Unit) (共用室外組件)	CU-4E23JBE (Shared Outdoor Unit) (共用室外組件)	CU-E18JBH/ CU-2E18CBPGW (Shared Outdoor Unit) (共用室外組件)	CU-E18JBH/ CU-2E18CBPGW (Shared Outdoor Unit) (共用室外組件)	CU-4E23JBE (Shared Outdoor Unit) (共用室外組件)	CU-4E23JBE (Shared Outdoor Unit) (共用室外組件)
Bedroom 1 睡房 1	Split Type Air-Conditioner 分體式冷氣機	Panasonic	Indoor Unit 室內機				Indoor Unit 室內機			
					CS-E15JKEW	CS-E15JKEW			CS-E15JKEW	CS-E15JKEW
			Outdoor Unit 室外機				Outdoor Unit 室外機			
					CU-4E23JBE (Shared Outdoor Unit) (共用室外組件)	CU-4E23JBE (Shared Outdoor Unit) (共用室外組件)			CU-4E23JBE (Shared Outdoor Unit) (共用室外組件)	CU-4E23JBE (Shared Outdoor Unit) (共用室外組件)

The vendor undertakes that if lifts and appliances of the specified brand name or model number are not installed in the Development, lifts or appliances of comparable quality will be installed.  
賣方承諾如該發展項目中沒有安裝指明的品牌名稱或產品型號的升降機或設備，便會安裝品質相若的升降機或設備。

#### Notes:

- The residential floors start from 7/F in all towers of the Development.
- There is no Tower 4 in the Development.
- There are no 4/F, 13/F, 14/F, 24/F and 34/F in all towers of the Development.
- There are no 6/F and 19/F in Tower 1 and Tower 2 and no 20/F and 21/F in Tower 6, Tower 7, Tower 9 and Tower 10.
- There are no 2/F in Tower 3, Tower 5, Tower 6, Tower 7, Tower 8, Tower 9 and Tower 10.
- The symbol “-” as shown in the above table denotes “Not Provided”.
- The cells shaded in grey “■” as shown in the above table denotes “Not Applicable”.

#### 備註：

- 發展項目內所有座樓之住宅由7樓開始。
- 發展項目不設第4座。
- 發展項目內所有座樓均不設4樓、13樓、14樓、24樓及34樓。
- 第1座及第2座均不設6樓及19樓；第6座、第7座、第9座及第10座均不設20樓及21樓。
- 第3座、第5座、第6座、第7座、第8座、第9座及第10座均不設2樓。
- 上表內之“-”符號代表“沒有提供”。
- 上表內填上灰色“■”之部分代表“不適用”。

# FITTINGS, FINISHES AND APPLIANCES

## 裝置、裝修物料及設備

### Appliances Schedule 設備說明表

#### Tower 8 第8座

Location 位置	Appliances 設備	Brand Name 品牌名稱	37/F to 38/F 37樓至38樓		
			A	C	D
			Model Number 產品型號		
Master Bedroom 主人房	Split Type Air-Conditioner 分體式冷氣機	Panasonic	Indoor Unit 室內機		
			CS-E23JD4H	CU-E15HD3EA	CU-E15HD3EA
			Outdoor Unit 室外機		
			CU-E23JBH	CU-4E23JBE (Shared Outdoor Unit) (共用室外組件)	CU-4E23JBE (Shared Outdoor Unit) (共用室外組件)
Bedroom 1 睡房 1	Split Type Air-Conditioner 分體式冷氣機	Panasonic	Indoor Unit 室內機		
			CS-E12JD4H/ CS-E18JD4H	CS-E15JKEW	CS-E15JKEW
			Outdoor Unit 室外機		
			CU-E12JBH/ CU-E18JBH	CU-4E23JBE (Shared Outdoor Unit) (共用室外組件)	CU-4E23JBE (Shared Outdoor Unit) (共用室外組件)

The vendor undertakes that if lifts and appliances of the specified brand name or model number are not installed in the Development, lifts or appliances of comparable quality will be installed.  
賣方承諾如該發展項目中沒有安裝指明的品牌名稱或產品型號的升降機或設備，便會安裝品質相若的升降機或設備。

#### Notes:

- The residential floors start from 7/F in all towers of the Development.
- There is no Tower 4 in the Development.
- There are no 4/F, 13/F, 14/F, 24/F and 34/F in all towers of the Development.
- There are no 6/F and 19/F in Tower 1 and Tower 2 and no 20/F and 21/F in Tower 6, Tower 7, Tower 9 and Tower 10.
- There are no 2/F in Tower 3, Tower 5, Tower 6, Tower 7, Tower 8, Tower 9 and Tower 10.
- The symbol “-” as shown in the above table denotes “Not Provided”.
- The cells shaded in grey “■” as shown in the above table denotes “Not Applicable”.

#### 備註：

- 發展項目內所有座樓之住宅由7樓開始。
- 發展項目不設第4座。
- 發展項目內所有座樓均不設4樓、13樓、14樓、24樓及34樓。
- 第1座及第2座均不設6樓及19樓；第6座、第7座、第9座及第10座均不設20樓及21樓。
- 第3座、第5座、第6座、第7座、第8座、第9座及第10座均不設2樓。
- 上表內之“-”符號代表“沒有提供”。
- 上表內填上灰色“■”之部分代表“不適用”。

# FITTINGS, FINISHES AND APPLIANCES

## 裝置、裝修物料及設備

### Appliances Schedule 設備說明表

#### Tower 8 第8座

Location 位置	Appliances 設備	Brand Name 品牌名稱	7/F 7樓				8/F to 36/F 8樓至36樓			
			A	B	C	D	A	B	C	D
			Model Number 產品型號							
Kitchen 廚房	Split Type Air-Conditioner 分體式冷氣機	Panasonic	Indoor Unit 室內機				Indoor Unit 室內機			
			CS-E15HD3EA	CS-E15HD3EA	-	-	CS-E15HD3EA	CS-E15HD3EA	-	-
			Outdoor Unit 室外機				Outdoor Unit 室外機			
			CU-4E23JBE (Shared Outdoor Unit) (共用室外組件)	CU-4E23JBE (Shared Outdoor Unit) (共用室外組件)	-	-	CU-4E23JBE (Shared Outdoor Unit) (共用室外組件)	CU-4E23JBE (Shared Outdoor Unit) (共用室外組件)	-	-

The vendor undertakes that if lifts and appliances of the specified brand name or model number are not installed in the Development, lifts or appliances of comparable quality will be installed.  
賣方承諾如該發展項目中沒有安裝指明的品牌名稱或產品型號的升降機或設備，便會安裝品質相若的升降機或設備。

#### Notes:

- The residential floors start from 7/F in all towers of the Development.
- There is no Tower 4 in the Development.
- There are no 4/F, 13/F, 14/F, 24/F and 34/F in all towers of the Development.
- There are no 6/F and 19/F in Tower 1 and Tower 2 and no 20/F and 21/F in Tower 6, Tower 7, Tower 9 and Tower 10.
- There are no 2/F in Tower 3, Tower 5, Tower 6, Tower 7, Tower 8, Tower 9 and Tower 10.
- The symbol “-” as shown in the above table denotes “Not Provided”.
- The cells shaded in grey “■” as shown in the above table denotes “Not Applicable”.

#### 備註：

- 發展項目內所有座樓之住宅由7樓開始。
- 發展項目不設第4座。
- 發展項目內所有座樓均不設4樓、13樓、14樓、24樓及34樓。
- 第1座及第2座均不設6樓及19樓；第6座、第7座、第9座及第10座均不設20樓及21樓。
- 第3座、第5座、第6座、第7座、第8座、第9座及第10座均不設2樓。
- 上表內之“-”符號代表“沒有提供”。
- 上表內填上灰色“■”之部分代表“不適用”。

# FITTINGS, FINISHES AND APPLIANCES

## 裝置、裝修物料及設備

### Appliances Schedule 設備說明表

#### Tower 8 第8座

Location 位置	Appliances 設備	Brand Name 品牌名稱	37/F to 38/F 37樓至38樓		
			A	C	D
			Model Number 產品型號		
Ensuite Bedroom 套房	Split Type Air-Conditioner 分體式冷氣機	Panasonic	Indoor Unit 室內機		
			CS-E18JD4H		
			Outdoor Unit 室外機		
			CU-E18JBH		
Kitchen 廚房	Split Type Air-Conditioner 分體式冷氣機	Panasonic	Indoor Unit 室內機		
			CS-E15HD3EA	-	-
			Outdoor Unit 室外機		
			CU-4E23JBE (Shared Outdoor Unit) (共用室外組件)	-	-

The vendor undertakes that if lifts and appliances of the specified brand name or model number are not installed in the Development, lifts or appliances of comparable quality will be installed.  
賣方承諾如該發展項目中沒有安裝指明的品牌名稱或產品型號的升降機或設備，便會安裝品質相若的升降機或設備。

#### Notes:

- The residential floors start from 7/F in all towers of the Development.
- There is no Tower 4 in the Development.
- There are no 4/F, 13/F, 14/F, 24/F and 34/F in all towers of the Development.
- There are no 6/F and 19/F in Tower 1 and Tower 2 and no 20/F and 21/F in Tower 6, Tower 7, Tower 9 and Tower 10.
- There are no 2/F in Tower 3, Tower 5, Tower 6, Tower 7, Tower 8, Tower 9 and Tower 10.
- The symbol “-” as shown in the above table denotes “Not Provided”.
- The cells shaded in grey “■” as shown in the above table denotes “Not Applicable”.

#### 備註：

- 發展項目內所有座樓之住宅由7樓開始。
- 發展項目不設第4座。
- 發展項目內所有座樓均不設4樓、13樓、14樓、24樓及34樓。
- 第1座及第2座均不設6樓及19樓；第6座、第7座、第9座及第10座均不設20樓及21樓。
- 第3座、第5座、第6座、第7座、第8座、第9座及第10座均不設2樓。
- 上表內之“-”符號代表“沒有提供”。
- 上表內填上灰色“■”之部分代表“不適用”。

# FITTINGS, FINISHES AND APPLIANCES

## 裝置、裝修物料及設備

### Appliances Schedule 設備說明表

#### Tower 8 第8座

Location 位置	Appliances 設備	Brand Name 品牌名稱	7/F 7樓				8/F to 36/F 8樓至36樓			
			A	B	C	D	A	B	C	D
			Model Number 產品型號							
Store leading from Kitchen 由廚房通往之 士多房	Split Type Air-Conditioner 分體式冷氣機	Panasonic	Indoor Unit 室內機				Indoor Unit 室內機			
			CS-E9JKEW	CS-E9JKEW			CS-E9JKEW	CS-E9JKEW		
			Outdoor Unit 室外機				Outdoor Unit 室外機			
			CU-4E23JBE (Shared Outdoor Unit) (共用室外組件)	CU-4E23JBE (Shared Outdoor Unit) (共用室外組件)			CU-4E23JBE (Shared Outdoor Unit) (共用室外組件)	CU-4E23JBE (Shared Outdoor Unit) (共用室外組件)		
Living Room, Dining Room & Corridor 客廳、飯廳及 走廊	Videophone 視像對講機	Bitron	AV2850/1	AV2850/1	AV2850/1	AV2850/1	AV2850/1	AV2850/1	AV2850/1	AV2850/1
	Door Bell 門鐘	Hager 海格	XC001	XC001	-	-	XC001	XC001	-	-

The vendor undertakes that if lifts and appliances of the specified brand name or model number are not installed in the Development, lifts or appliances of comparable quality will be installed.  
賣方承諾如該發展項目中沒有安裝指明的品牌名稱或產品型號的升降機或設備，便會安裝品質相若的升降機或設備。

#### Notes:

- The residential floors start from 7/F in all towers of the Development.
- There is no Tower 4 in the Development.
- There are no 4/F, 13/F, 14/F, 24/F and 34/F in all towers of the Development.
- There are no 6/F and 19/F in Tower 1 and Tower 2 and no 20/F and 21/F in Tower 6, Tower 7, Tower 9 and Tower 10.
- There are no 2/F in Tower 3, Tower 5, Tower 6, Tower 7, Tower 8, Tower 9 and Tower 10.
- The symbol “-” as shown in the above table denotes “Not Provided”.
- The cells shaded in grey “■” as shown in the above table denotes “Not Applicable”.

#### 備註：

- 發展項目內所有座樓之住宅由7樓開始。
- 發展項目不設第4座。
- 發展項目內所有座樓均不設4樓、13樓、14樓、24樓及34樓。
- 第1座及第2座均不設6樓及19樓；第6座、第7座、第9座及第10座均不設20樓及21樓。
- 第3座、第5座、第6座、第7座、第8座、第9座及第10座均不設2樓。
- 上表內之“-”符號代表“沒有提供”。
- 上表內填上灰色“■”之部分代表“不適用”。

# FITTINGS, FINISHES AND APPLIANCES

## 裝置、裝修物料及設備

### Appliances Schedule 設備說明表

#### Tower 8 第8座

Location 位置	Appliances 設備	Brand Name 品牌名稱	37/F to 38/F 37樓至38樓		
			A	C	D
			Model Number 產品型號		
Store leading from Kitchen 由廚房通往之 士多房	Split Type Air-Conditioner 分體式冷氣機	Panasonic	Indoor Unit 室內機		
			CS-E9JKEW		
			Outdoor Unit 室外機		
			CU-4E23JBE (Shared Outdoor Unit) (共用室外組件)		
Living Room, Dining Room & Corridor 客廳、飯廳及 走廊	Door Bell 門鐘	Hager 海格	XC001	-	-

The vendor undertakes that if lifts and appliances of the specified brand name or model number are not installed in the Development, lifts or appliances of comparable quality will be installed.  
賣方承諾如該發展項目中沒有安裝指明的品牌名稱或產品型號的升降機或設備，便會安裝品質相若的升降機或設備。

#### Notes:

- The residential floors start from 7/F in all towers of the Development.
- There is no Tower 4 in the Development.
- There are no 4/F, 13/F, 14/F, 24/F and 34/F in all towers of the Development.
- There are no 6/F and 19/F in Tower 1 and Tower 2 and no 20/F and 21/F in Tower 6, Tower 7, Tower 9 and Tower 10.
- There are no 2/F in Tower 3, Tower 5, Tower 6, Tower 7, Tower 8, Tower 9 and Tower 10.
- The symbol “-” as shown in the above table denotes “Not Provided”.
- The cells shaded in grey “■” as shown in the above table denotes “Not Applicable”.

#### 備註：

- 發展項目內所有座樓之住宅由7樓開始。
- 發展項目不設第4座。
- 發展項目內所有座樓均不設4樓、13樓、14樓、24樓及34樓。
- 第1座及第2座均不設6樓及19樓；第6座、第7座、第9座及第10座均不設20樓及21樓。
- 第3座、第5座、第6座、第7座、第8座、第9座及第10座均不設2樓。
- 上表內之“-”符號代表“沒有提供”。
- 上表內填上灰色“■”之部分代表“不適用”。

# FITTINGS, FINISHES AND APPLIANCES

## 裝置、裝修物料及設備

### Appliances Schedule 設備說明表

#### Tower 8 第8座

Location 位置	Appliances 設備	Brand Name 品牌名稱	7/F 7樓				8/F to 36/F 8樓至36樓			
			A	B	C	D	A	B	C	D
			Model Number 產品型號							
Kitchen 廚房	Cooker Hood 抽油煙機	Miele 美諾	DA3190	DA3190	DA3190	DA3190	DA3190	DA3190	DA3190	DA3190
	Gas Cooking Hob 煤氣煮食爐	Miele 美諾	CS1018G CS1013G	CS1018G CS1013G	CS1018G CS1013G	CS1018G CS1013G	CS1018G CS1013G	CS1018G CS1013G	CS1018G CS1013G	CS1018G CS1013G
	Gas Water Heater 煤氣熱水爐	TGC	NJW160TFQL <sup>(1)</sup>	NJW160TFQL <sup>(1)</sup>	NJW160TFQL <sup>(2)</sup>	NJW160TFQL <sup>(2)</sup>	NJW160TFQL <sup>(1)</sup>	NJW160TFQL <sup>(1)</sup>	NJW160TFQL <sup>(2)</sup>	NJW160TFQL <sup>(2)</sup>
	Microwave Oven 微波爐	Miele 美諾	M8161-2	M8161-2	M8161-2	M8161-2	M8161-2	M8161-2	M8161-2	M8161-2
	Refrigerator 雪櫃	Siemens 西門子	KI38VA/ KU15R	KI38VA/ KU15R	KI38VA	KI38VA	KI38VA/ KU15R	KI38VA/ KU15R	KI38VA	KI38VA
	Washer/Dryer 洗衣/乾衣機	Siemens 西門子	WK16D	WK16D	WK16D	WK16D	WK16D	WK16D	WK16D	WK16D
	Exhaust Fan 抽氣扇	Xpelair	GX 6	GX 6	GX 6	GX 6	GX 6	GX 6	GX 6	GX 6

The vendor undertakes that if lifts and appliances of the specified brand name or model number are not installed in the Development, lifts or appliances of comparable quality will be installed.  
賣方承諾如該發展項目中沒有安裝指明的品牌名稱或產品型號的升降機或設備，便會安裝品質相若的升降機或設備。

#### Notes:

- The residential floors start from 7/F in all towers of the Development.
  - There is no Tower 4 in the Development.
  - There are no 4/F, 13/F, 14/F, 24/F and 34/F in all towers of the Development.
  - There are no 6/F and 19/F in Tower 1 and Tower 2 and no 20/F and 21/F in Tower 6, Tower 7, Tower 9 and Tower 10.
  - There are no 2/F in Tower 3, Tower 5, Tower 6, Tower 7, Tower 8, Tower 9 and Tower 10.
  - The symbol “-” as shown in the above table denotes “Not Provided”.
  - The cells shaded in grey “■” as shown in the above table denotes “Not Applicable”.
- (1) :The gas water heater located at A/C room & served for Lavatory leading from Kitchen, Kitchen and Bathroom  
(2) :The gas water heater located at A/C room & served for Kitchen and Bathroom  
(3) :The gas water heater located at A/C room & served for Lavatory leading from Kitchen and Bathroom next to Ensuite Bedroom

#### 備註：

- 發展項目內所有座樓之住宅由7樓開始。
  - 發展項目不設第4座。
  - 發展項目內所有座樓均不設4樓、13樓、14樓、24樓及34樓。
  - 第1座及第2座均不設6樓及19樓；第6座、第7座、第9座及第10座均不設20樓及21樓。
  - 第3座、第5座、第6座、第7座、第8座、第9座及第10座均不設2樓。
  - 上表內之“-”符號代表“沒有提供”。
  - 上表內填上灰色“■”之部分代表“不適用”。
- (1) : 該款煤氣熱水爐位於冷氣機房及供應熱水給由廚房通往之洗手間、廚房和浴室  
(2) : 該款煤氣熱水爐位於冷氣機房及供應熱水給廚房和浴室  
(3) : 該款煤氣熱水爐位於冷氣機房及供應熱水給由廚房通往之洗手間和套房旁之浴室

# FITTINGS, FINISHES AND APPLIANCES

## 裝置、裝修物料及設備

### Appliances Schedule 設備說明表

#### Tower 8 第8座

Location 位置	Appliances 設備	Brand Name 品牌名稱	37/F to 38/F 37樓至38樓		
			A	C	D
			Model Number 產品型號		
Kitchen 廚房	Cooker Hood 抽油煙機	Miele 美諾	DA422-4	DA3190	DA3190
	Gas Cooking Hob 煤氣煮食爐	Miele 美諾	CS1018G CS1013G	CS1018G CS1013G	CS1018G CS1013G
	Gas Water Heater 煤氣熱水爐	TGC	NJW220TFQL <sup>(2)</sup>	NJW160TFQL <sup>(2)</sup>	NJW160TFQL <sup>(2)</sup>
	Microwave Oven 微波爐	Miele 美諾	M8161-2	M8161-2	M8161-2
	Refrigerator 雪櫃	Siemens 西門子	-	KI38VA	KI38VA
Sub-Zero		ICBBI-42S	-	-	

The vendor undertakes that if lifts and appliances of the specified brand name or model number are not installed in the Development, lifts or appliances of comparable quality will be installed.  
賣方承諾如該發展項目中沒有安裝指明的品牌名稱或產品型號的升降機或設備，便會安裝品質相若的升降機或設備。

#### Notes:

- The residential floors start from 7/F in all towers of the Development.
  - There is no Tower 4 in the Development.
  - There are no 4/F, 13/F, 14/F, 24/F and 34/F in all towers of the Development.
  - There are no 6/F and 19/F in Tower 1 and Tower 2 and no 20/F and 21/F in Tower 6, Tower 7, Tower 9 and Tower 10.
  - There are no 2/F in Tower 3, Tower 5, Tower 6, Tower 7, Tower 8, Tower 9 and Tower 10.
  - The symbol “-” as shown in the above table denotes “Not Provided”.
  - The cells shaded in grey “■” as shown in the above table denotes “Not Applicable”.
- (1): The gas water heater located at A/C room & served for Lavatory leading from Kitchen, Kitchen and Bathroom  
(2): The gas water heater located at A/C room & served for Kitchen and Bathroom  
(3): The gas water heater located at A/C room & served for Lavatory leading from Kitchen and Bathroom next to Ensuite Bedroom

#### 備註:

- 發展項目內所有座樓之住宅由7樓開始。
  - 發展項目不設第4座。
  - 發展項目內所有座樓均不設4樓、13樓、14樓、24樓及34樓。
  - 第1座及第2座均不設6樓及19樓；第6座、第7座、第9座及第10座均不設20樓及21樓。
  - 第3座、第5座、第6座、第7座、第8座、第9座及第10座均不設2樓。
  - 上表內之“-”符號代表“沒有提供”。
  - 上表內填上灰色“■”之部分代表“不適用”。
- (1): 該款煤氣熱水爐位於冷氣機房及供應熱水給由廚房通往之洗手間、廚房和浴室  
(2): 該款煤氣熱水爐位於冷氣機房及供應熱水給廚房和浴室  
(3): 該款煤氣熱水爐位於冷氣機房及供應熱水給由廚房通往之洗手間和套房旁之浴室



# FITTINGS, FINISHES AND APPLIANCES

## 裝置、裝修物料及設備

### Appliances Schedule 設備說明表

#### Tower 8 第8座

Location 位置	Appliances 設備	Brand Name 品牌名稱	7/F 7樓				8/F to 36/F 8樓至36樓			
			A	B	C	D	A	B	C	D
			Model Number 產品型號							
Kitchen 廚房	Induction Hob 電磁爐	Miele 美諾	CS1212	CS1212	-	-	CS1212	CS1212	-	-
	Steam Oven 電蒸爐	Miele 美諾	DGC5051	DGC5051	-	-	DGC5051	DGC5051	-	-
	Wine Cellar 酒櫃	Miele 美諾	KWT4154UG-1	KWT4154UG-1	-	-	KWT4154UG-1	KWT4154UG-1	-	-
	Door Bell 門鐘	Hager 海格	XC001	XC001	XC001	XC001	XC001	XC001	XC001	XC001

The vendor undertakes that if lifts and appliances of the specified brand name or model number are not installed in the Development, lifts or appliances of comparable quality will be installed.  
賣方承諾如該發展項目中沒有安裝指明的品牌名稱或產品型號的升降機或設備，便會安裝品質相若的升降機或設備。

#### Notes:

- The residential floors start from 7/F in all towers of the Development.
- There is no Tower 4 in the Development.
- There are no 4/F, 13/F, 14/F, 24/F and 34/F in all towers of the Development.
- There are no 6/F and 19/F in Tower 1 and Tower 2 and no 20/F and 21/F in Tower 6, Tower 7, Tower 9 and Tower 10.
- There are no 2/F in Tower 3, Tower 5, Tower 6, Tower 7, Tower 8, Tower 9 and Tower 10.
- The symbol “-” as shown in the above table denotes “Not Provided”.
- The cells shaded in grey “■” as shown in the above table denotes “Not Applicable”.

#### 備註：

- 發展項目內所有座樓之住宅由7樓開始。
- 發展項目不設第4座。
- 發展項目內所有座樓均不設4樓、13樓、14樓、24樓及34樓。
- 第1座及第2座均不設6樓及19樓；第6座、第7座、第9座及第10座均不設20樓及21樓。
- 第3座、第5座、第6座、第7座、第8座、第9座及第10座均不設2樓。
- 上表內之“-”符號代表“沒有提供”。
- 上表內填上灰色“■”之部分代表“不適用”。

# FITTINGS, FINISHES AND APPLIANCES

## 裝置、裝修物料及設備

### Appliances Schedule 設備說明表

#### Tower 8 第8座

Location 位置	Appliances 設備	Brand Name 品牌名稱	37/F to 38/F 37樓至38樓		
			A	C	D
			Model Number 產品型號		
Kitchen 廚房	Washer/Dryer 洗衣/乾衣機	Miele 美諾	WT2789i	-	-
		Siemens 西門子	-	WK16D	WK16D
	Exhaust Fan 抽氣扇	Xpelair	GX 6	GX 6	GX 6
	Induction Hob 電磁爐	Miele 美諾	CS1212	-	-
	Steam Oven 電蒸爐	Miele 美諾	DGC5051	-	-
	Wine Cellar 酒櫃	Miele 美諾	KWT4154UG-1	-	-
	Door Bell 門鐘	Hager 海格	XC001	XC001	XC001
	Videophone 視像對講機	Bitron	AV2850/1	AV2850/1	AV2850/1

The vendor undertakes that if lifts and appliances of the specified brand name or model number are not installed in the Development, lifts or appliances of comparable quality will be installed.  
賣方承諾如該發展項目中沒有安裝指明的品牌名稱或產品型號的升降機或設備，便會安裝品質相若的升降機或設備。

#### Notes:

- The residential floors start from 7/F in all towers of the Development.
- There is no Tower 4 in the Development.
- There are no 4/F, 13/F, 14/F, 24/F and 34/F in all towers of the Development.
- There are no 6/F and 19/F in Tower 1 and Tower 2 and no 20/F and 21/F in Tower 6, Tower 7, Tower 9 and Tower 10.
- There are no 2/F in Tower 3, Tower 5, Tower 6, Tower 7, Tower 8, Tower 9 and Tower 10.
- The symbol “-” as shown in the above table denotes “Not Provided”.
- The cells shaded in grey “■” as shown in the above table denotes “Not Applicable”.

#### 備註：

- 發展項目內所有座樓之住宅由7樓開始。
- 發展項目不設第4座。
- 發展項目內所有座樓均不設4樓、13樓、14樓、24樓及34樓。
- 第1座及第2座均不設6樓及19樓；第6座、第7座、第9座及第10座均不設20樓及21樓。
- 第3座、第5座、第6座、第7座、第8座、第9座及第10座均不設2樓。
- 上表內之“-”符號代表“沒有提供”。
- 上表內填上灰色“■”之部分代表“不適用”。

# FITTINGS, FINISHES AND APPLIANCES

## 裝置、裝修物料及設備

### Appliances Schedule 設備說明表

#### Tower 8 第8座

Location 位置	Appliances 設備	Brand Name 品牌名稱	7/F 7樓				8/F to 36/F 8樓至36樓			
			A	B	C	D	A	B	C	D
			Model Number 產品型號							
Bathroom in Master Bedroom 主人房內之浴室	10"LCD TV 10"液晶電視	JSA	TMBG10i	TMBG10i	-	-	TMBG10i	TMBG10i	-	-
	Gas Water Heater 煤氣熱水爐	TGC	NJW220TFQL	NJW220TFQL	NJW220TFQL	NJW220TFQL	NJW220TFQL	NJW220TFQL	NJW220TFQL	NJW220TFQL
	Exhaust Fan 抽氣扇	Xpelair	-	-	GX 6	GX 6	-	-	GX 6	GX 6
Ostberg 奧斯博格		RFE 140B	RFE 140B	-	-	RFE 140A	RFE 140A	-	-	
Bathroom 浴室	Gas Water Heater 煤氣熱水爐	TGC	NJW160TFQL <sup>(1)</sup>	NJW160TFQL <sup>(1)</sup>	NJW160TFQL <sup>(2)</sup>	NJW160TFQL <sup>(2)</sup>	NJW160TFQL <sup>(1)</sup>	NJW160TFQL <sup>(1)</sup>	NJW160TFQL <sup>(2)</sup>	NJW160TFQL <sup>(2)</sup>
	Exhaust Fan 抽氣扇	Ostberg 奧斯博格	RFE 140B	RFE 140B	RFE 140A	RFE 140A	RFE 140A	RFE 140A	RFE 140A	RFE 140A

The vendor undertakes that if lifts and appliances of the specified brand name or model number are not installed in the Development, lifts or appliances of comparable quality will be installed.  
賣方承諾如該發展項目中沒有安裝指明的品牌名稱或產品型號的升降機或設備，便會安裝品質相若的升降機或設備。

#### Notes:

- The residential floors start from 7/F in all towers of the Development.
  - There is no Tower 4 in the Development.
  - There are no 4/F, 13/F, 14/F, 24/F and 34/F in all towers of the Development.
  - There are no 6/F and 19/F in Tower 1 and Tower 2 and no 20/F and 21/F in Tower 6, Tower 7, Tower 9 and Tower 10.
  - There are no 2/F in Tower 3, Tower 5, Tower 6, Tower 7, Tower 8, Tower 9 and Tower 10.
  - The symbol "-" as shown in the above table denotes "Not Provided".
  - The cells shaded in grey "■" as shown in the above table denotes "Not Applicable".
- (1) :The gas water heater located at A/C room & served for Lavatory leading from Kitchen, Kitchen and Bathroom  
(2) :The gas water heater located at A/C room & served for Kitchen and Bathroom  
(3) :The gas water heater located at A/C room & served for Lavatory leading from Kitchen and Bathroom next to Ensuite Bedroom

#### 備註：

- 發展項目內所有座樓之住宅由7樓開始。
  - 發展項目不設第4座。
  - 發展項目內所有座樓均不設4樓、13樓、14樓、24樓及34樓。
  - 第1座及第2座均不設6樓及19樓；第6座、第7座、第9座及第10座均不設20樓及21樓。
  - 第3座、第5座、第6座、第7座、第8座、第9座及第10座均不設2樓。
  - 上表內之“-”符號代表“沒有提供”。
  - 上表內填上灰色“■”之部分代表“不適用”。
- (1) : 該款煤氣熱水爐位於冷氣機房及供應熱水給由廚房通往之洗手間、廚房和浴室  
(2) : 該款煤氣熱水爐位於冷氣機房及供應熱水給廚房和浴室  
(3) : 該款煤氣熱水爐位於冷氣機房及供應熱水給由廚房通往之洗手間和套房旁之浴室

# FITTINGS, FINISHES AND APPLIANCES

## 裝置、裝修物料及設備

### Appliances Schedule 設備說明表

#### Tower 8 第8座

Location 位置	Appliances 設備	Brand Name 品牌名稱	37/F to 38/F 37樓至38樓		
			A	C	D
			Model Number 產品型號		
Bathroom in Master Bedroom 主人房內之浴室	15"LCD TV 15"液晶體電視	JSA	TMBG15	-	-
	Ceiling Speaker 揚聲器	KEF	2 x Cs130.2FS	-	-
	Gas Water Heater 煤氣熱水爐	TGC	NJW220TFQL	NJW220TFQL	NJW220TFQL
	Exhaust Fan 抽氣扇	Xpelair	-	GX 6	GX 6
Ostberg 奧斯博格		RFE 200B	-	-	
Bathroom 浴室	Gas Water Heater 煤氣熱水爐	TGC	NJW220TFQL <sup>(2)</sup>	NJW160TFQL <sup>(2)</sup>	NJW160TFQL <sup>(2)</sup>
	Exhaust Fan 抽氣扇	Ostberg 奧斯博格	RFE 140A	RFE 140A	RFE 140A

The vendor undertakes that if lifts and appliances of the specified brand name or model number are not installed in the Development, lifts or appliances of comparable quality will be installed.  
賣方承諾如該發展項目中沒有安裝指明的品牌名稱或產品型號的升降機或設備，便會安裝品質相若的升降機或設備。

#### Notes:

- The residential floors start from 7/F in all towers of the Development.
  - There is no Tower 4 in the Development.
  - There are no 4/F, 13/F, 14/F, 24/F and 34/F in all towers of the Development.
  - There are no 6/F and 19/F in Tower 1 and Tower 2 and no 20/F and 21/F in Tower 6, Tower 7, Tower 9 and Tower 10.
  - There are no 2/F in Tower 3, Tower 5, Tower 6, Tower 7, Tower 8, Tower 9 and Tower 10.
  - The symbol “-” as shown in the above table denotes “Not Provided”.
  - The cells shaded in grey “■” as shown in the above table denotes “Not Applicable”.
- (1): The gas water heater located at A/C room & served for Lavatory leading from Kitchen, Kitchen and Bathroom  
(2): The gas water heater located at A/C room & served for Kitchen and Bathroom  
(3): The gas water heater located at A/C room & served for Lavatory leading from Kitchen and Bathroom next to Ensuite Bedroom

#### 備註:

- 發展項目內所有座樓之住宅由7樓開始。
  - 發展項目不設第4座。
  - 發展項目內所有座樓均不設4樓、13樓、14樓、24樓及34樓。
  - 第1座及第2座均不設6樓及19樓；第6座、第7座、第9座及第10座均不設20樓及21樓。
  - 第3座、第5座、第6座、第7座、第8座、第9座及第10座均不設2樓。
  - 上表內之“-”符號代表“沒有提供”。
  - 上表內填上灰色“■”之部分代表“不適用”。
- (1): 該款煤氣熱水爐位於冷氣機房及供應熱水給由廚房通往之洗手間、廚房和浴室  
(2): 該款煤氣熱水爐位於冷氣機房及供應熱水給廚房和浴室  
(3): 該款煤氣熱水爐位於冷氣機房及供應熱水給由廚房通往之洗手間和套房旁之浴室

# FITTINGS, FINISHES AND APPLIANCES

## 裝置、裝修物料及設備

### Appliances Schedule 設備說明表

#### Tower 8 第8座

Location 位置	Appliances 設備	Brand Name 品牌名稱	7/F 7樓				8/F to 36/F 8樓至36樓			
			A	B	C	D	A	B	C	D
			Model Number 產品型號							
Lavatory leading from Kitchen 由廚房通往之洗手間	Gas Water Heater 煤氣熱水爐	TGC	NJW160TFQL <sup>(1)</sup>	NJW160TFQL <sup>(1)</sup>			NJW160TFQL <sup>(1)</sup>	NJW160TFQL <sup>(1)</sup>		

The vendor undertakes that if lifts and appliances of the specified brand name or model number are not installed in the Development, lifts or appliances of comparable quality will be installed.  
賣方承諾如該發展項目中沒有安裝指明的品牌名稱或產品型號的升降機或設備，便會安裝品質相若的升降機或設備。

#### Notes:

- The residential floors start from 7/F in all towers of the Development.
  - There is no Tower 4 in the Development.
  - There are no 4/F, 13/F, 14/F, 24/F and 34/F in all towers of the Development.
  - There are no 6/F and 19/F in Tower 1 and Tower 2 and no 20/F and 21/F in Tower 6, Tower 7, Tower 9 and Tower 10.
  - There are no 2/F in Tower 3, Tower 5, Tower 6, Tower 7, Tower 8, Tower 9 and Tower 10.
  - The symbol “-” as shown in the above table denotes “Not Provided”.
  - The cells shaded in grey “■” as shown in the above table denotes “Not Applicable”.
- (1) :The gas water heater located at A/C room & served for Lavatory leading from Kitchen, Kitchen and Bathroom  
(2) :The gas water heater located at A/C room & served for Kitchen and Bathroom  
(3) :The gas water heater located at A/C room & served for Lavatory leading from Kitchen and Bathroom next to Ensuite Bedroom

#### 備註：

- 發展項目內所有座樓之住宅由7樓開始。
  - 發展項目不設第4座。
  - 發展項目內所有座樓均不設4樓、13樓、14樓、24樓及34樓。
  - 第1座及第2座均不設6樓及19樓；第6座、第7座、第9座及第10座均不設20樓及21樓。
  - 第3座、第5座、第6座、第7座、第8座、第9座及第10座均不設2樓。
  - 上表內之“-”符號代表“沒有提供”。
  - 上表內填上灰色“■”之部分代表“不適用”。
- (1) : 該款煤氣熱水爐位於冷氣機房及供應熱水給由廚房通往之洗手間、廚房和浴室  
(2) : 該款煤氣熱水爐位於冷氣機房及供應熱水給廚房和浴室  
(3) : 該款煤氣熱水爐位於冷氣機房及供應熱水給由廚房通往之洗手間和套房旁之浴室

# FITTINGS, FINISHES AND APPLIANCES

## 裝置、裝修物料及設備

### Appliances Schedule 設備說明表

#### Tower 8 第8座

Location 位置	Appliances 設備	Brand Name 品牌名稱	37/F to 38/F 37樓至38樓		
			A	C	D
			Model Number 產品型號		
Bathroom next to Ensuite Bedroom 套房旁之浴室	Gas Water Heater 煤氣熱水爐	TGC	NJW220TFQL <sup>(3)</sup>		
	Exhaust Fan 抽氣扇	Ostberg 奧斯博格	RFE 140A		
Lavatory leading from Kitchen 由廚房通往之 洗手間	Gas Water Heater 煤氣熱水爐	TGC	NJW220TFQL <sup>(3)</sup>		
	Exhaust Fan 抽氣扇	Xpelair	GX 6		

The vendor undertakes that if lifts and appliances of the specified brand name or model number are not installed in the Development, lifts or appliances of comparable quality will be installed.  
賣方承諾如該發展項目中沒有安裝指明的品牌名稱或產品型號的升降機或設備，便會安裝品質相若的升降機或設備。

#### Notes:

- The residential floors start from 7/F in all towers of the Development.
  - There is no Tower 4 in the Development.
  - There are no 4/F, 13/F, 14/F, 24/F and 34/F in all towers of the Development.
  - There are no 6/F and 19/F in Tower 1 and Tower 2 and no 20/F and 21/F in Tower 6, Tower 7, Tower 9 and Tower 10.
  - There are no 2/F in Tower 3, Tower 5, Tower 6, Tower 7, Tower 8, Tower 9 and Tower 10.
  - The symbol “-” as shown in the above table denotes “Not Provided”.
  - The cells shaded in grey “■” as shown in the above table denotes “Not Applicable”.
- (1): The gas water heater located at A/C room & served for Lavatory leading from Kitchen, Kitchen and Bathroom  
(2): The gas water heater located at A/C room & served for Kitchen and Bathroom  
(3): The gas water heater located at A/C room & served for Lavatory leading from Kitchen and Bathroom next to Ensuite Bedroom

#### 備註:

- 發展項目內所有座樓之住宅由7樓開始。
  - 發展項目不設第4座。
  - 發展項目內所有座樓均不設4樓、13樓、14樓、24樓及34樓。
  - 第1座及第2座均不設6樓及19樓；第6座、第7座、第9座及第10座均不設20樓及21樓。
  - 第3座、第5座、第6座、第7座、第8座、第9座及第10座均不設2樓。
  - 上表內之“-”符號代表“沒有提供”。
  - 上表內填上灰色“■”之部分代表“不適用”。
- (1): 該款煤氣熱水爐位於冷氣機房及供應熱水給由廚房通往之洗手間、廚房和浴室  
(2): 該款煤氣熱水爐位於冷氣機房及供應熱水給廚房和浴室  
(3): 該款煤氣熱水爐位於冷氣機房及供應熱水給由廚房通往之洗手間和套房旁之浴室

# FITTINGS, FINISHES AND APPLIANCES

## 裝置、裝修物料及設備

### Schedule of Mechanical and Electrical Provisions 機電裝置數量說明表

#### Tower 8 第8座

Location 位置	Exposed Type 外露型	Non-Exposed Type 非外露型	7/F 7樓				8/F to 36/F 8樓至36樓				37/F 37樓			38/F 38樓			
			A	B	C	D	A	B	C	D	A	C	D	A	C	D	
Living Room, Dining Room & Corridor 客廳、飯廳及 走廊	TV/ FM Outlet 電視/電台天線插座		3	3	2	2	3	3	2	2	2	2	2	2	2	2	
	Telephone Outlet 電話插座		2	2	1	1	2	2	1	1	2	1	1	2	1	1	
	13A Twin Socket Outlet 13A雙位電插座		5	5	2	2	6	6	4	4	5	4	4	5	4	4	
	13A Single Socket Outlet 13A單位電插座		5	5	5	5	3	3	5	5	5	5	5	4	5	5	
	Lighting Switch 燈掣		7	7	5	5	6	6	5	5	10	5	5	10	5	5	
		Door Bell 門鐘		1	1	-	-	1	1	-	-	1	-	-	1	-	-
		Door Phone Handset 對講機		1	1	1	1	1	1	1	1	-	1	1	-	1	1
		20A Double Pole Switch with Pilot Lamp 20A 雙極開關掣		2	2	2	2	2	2	2	2	3	2	2	3	2	2
	Fused Spur Unit/Connection Unit 接線座		1	1	-	-	1	1	-	-	1	-	-	1	-	-	
Master Bedroom 主人房	TV/ FM Outlet 電視/電台天線插座		2	2	1	1	2	2	1	1	2	1	1	2	1	1	
	Telephone Outlet 電話插座		2	2	1	1	2	2	1	1	2	1	1	2	1	1	
	13A Twin Socket Outlet 13A雙位電插座		3	3	2	2	3	3	2	2	4	2	2	4	2	2	
	13A Single Socket Outlet 13A單位電插座		1	1	1	1	1	1	1	1	2	1	1	2	1	1	
	Lighting Switch 燈掣		4	4	2	2	3	3	2	2	3	2	2	3	2	2	
	20A Double Pole Switch with Pilot Lamp 20A 雙極開關掣		1	1	1	1	1	1	1	1	2	1	1	2	1	1	

#### Notes:

- The residential floors start from 7/F in all towers of the Development.
- There is no Tower 4 in the Development.
- There are no 4/F, 13/F, 14/F, 24/F and 34/F in all towers of the Development.
- There are no 6/F and 19/F in Tower 1 and Tower 2 and no 20/F and 21/F in Tower 6, Tower 7, Tower 9 and Tower 10.
- There are no 2/F in Tower 3, Tower 5, Tower 6, Tower 7, Tower 8, Tower 9 and Tower 10.
- The symbol “-” as shown in the above table denotes “Not Provided”.
- The cells shaded in grey “■” as shown in the above table denotes “Not Applicable”.

#### 備註：

- 發展項目內所有座樓之住宅由7樓開始。
- 發展項目不設第4座。
- 發展項目內所有座樓均不設4樓、13樓、14樓、24樓及34樓。
- 第1座及第2座均不設6樓及19樓；第6座、第7座、第9座及第10座均不設20樓及21樓。
- 第3座、第5座、第6座、第7座、第8座、第9座及第10座均不設2樓。
- 上表內之“-”符號代表“沒有提供”。
- 上表內填上灰色“■”之部分代表“不適用”。

# FITTINGS, FINISHES AND APPLIANCES

## 裝置、裝修物料及設備

### Schedule of Mechanical and Electrical Provisions 機電裝置數量說明表

#### Tower 8 第8座

Location 位置	Exposed Type 外露型	Non-Exposed Type 非外露型	7/F 7樓				8/F to 36/F 8樓至36樓				37/F 37樓			38/F 38樓		
			A	B	C	D	A	B	C	D	A	C	D	A	C	D
Bedroom 1 睡房 1	TV/ FM Outlet 電視/電台天線插座				1	1			1	1	2	1	1	2	1	1
	Telephone Outlet 電話插座			1	1			1	1	2	1	1	2	1	1	
	13A Twin Socket Outlet 13A雙位電插座			2	2			2	2	2	2	2	2	2	2	
	13A Single Socket Outlet 13A單位電插座			-	-			-	-	1	-	-	1	-	-	
	Lighting Switch 燈掣			1	1			1	1	2	1	1	2	1	1	
Ensuite Bedroom 套房	TV/ FM Outlet 電視/電台天線插座									2			2			
	Telephone Outlet 電話插座									1			1			
	13A Twin Socket Outlet 13A雙位電插座									4			4			
	13A Single Socket Outlet 13A單位電插座									2			2			
	Lighting Switch 燈掣									3			2			

#### Notes:

- The residential floors start from 7/F in all towers of the Development.
- There is no Tower 4 in the Development.
- There are no 4/F, 13/F, 14/F, 24/F and 34/F in all towers of the Development.
- There are no 6/F and 19/F in Tower 1 and Tower 2 and no 20/F and 21/F in Tower 6, Tower 7, Tower 9 and Tower 10.
- There are no 2/F in Tower 3, Tower 5, Tower 6, Tower 7, Tower 8, Tower 9 and Tower 10.
- The symbol “-” as shown in the above table denotes “Not Provided”.
- The cells shaded in grey “■” as shown in the above table denotes “Not Applicable”.

#### 備註：

- 發展項目內所有座樓之住宅由7樓開始。
- 發展項目不設第4座。
- 發展項目內所有座樓均不設4樓、13樓、14樓、24樓及34樓。
- 第1座及第2座均不設6樓及19樓；第6座、第7座、第9座及第10座均不設20樓及21樓。
- 第3座、第5座、第6座、第7座、第8座、第9座及第10座均不設2樓。
- 上表內之“-”符號代表“沒有提供”。
- 上表內填上灰色“■”之部分代表“不適用”。



# FITTINGS, FINISHES AND APPLIANCES

## 裝置、裝修物料及設備

Schedule of Mechanical and Electrical Provisions  
機電裝置數量說明表

### Tower 8 第8座

Location 位置	Exposed Type 外露型	Non-Exposed Type 非外露型	7/F 7樓				8/F to 36/F 8樓至36樓				37/F 37樓			38/F 38樓		
			A	B	C	D	A	B	C	D	A	C	D	A	C	D
Store leading from Kitchen 由廚房通往之 士多房	TV/ FM Outlet 電視/電台天線插座		1	1			1	1			1			1		
	Telephone Outlet 電話插座		-	-			-	-			1			1		
	13A Twin Socket Outlet 13A雙位電插座		1	1			1	1			1			1		
	Lighting Switch 燈掣		1	1			1	1			2			2		
	20A Double Pole Switch with Pilot Lamp 20A 雙極開關掣		1	1			1	1			1			1		
Store near to Living Room 鄰近客廳之 士多房	13A Single Socket Outlet 13A單位電插座									1			1			
	Lighting Switch 燈掣									1			-			
Bathroom in Master Bedroom 主人房內之浴室	TV/ FM Outlet 電視/電台天線插座		1	1	1	1	1	1	1	1	1	1	1	1	1	
	13A Single Socket Outlet 13A單位電插座		3	3	2	2	3	3	2	2	3	2	2	3	2	2
	Fused Spur Unit/Connection Unit 接線座		1	1	1	1	1	1	1	1	1	1	1	1	1	1
Bathroom 浴室	13A Single Socket Outlet 13A單位電插座		1	1	1	1	1	1	1	1	1	1	1	1	1	1
	Fused Spur Unit/Connection Unit 接線座		1	1	1	1	1	1	1	1	1	1	1	1	1	1
Bathroom next to Ensuite Bedroom 套房旁之浴室	13A Single Socket Outlet 13A單位電插座										1			1		
	Fused Spur Unit/Connection Unit 接線座										1			1		

Notes:

- The residential floors start from 7/F in all towers of the Development.
- There is no Tower 4 in the Development.
- There are no 4/F, 13/F, 14/F, 24/F and 34/F in all towers of the Development.
- There are no 6/F and 19/F in Tower 1 and Tower 2 and no 20/F and 21/F in Tower 6, Tower 7, Tower 9 and Tower 10.
- There are no 2/F in Tower 3, Tower 5, Tower 6, Tower 7, Tower 8, Tower 9 and Tower 10.
- The symbol “-” as shown in the above table denotes “Not Provided”.
- The cells shaded in grey “■” as shown in the above table denotes “Not Applicable”.

備註：

- 發展項目內所有座樓之住宅由7樓開始。
- 發展項目不設第4座。
- 發展項目內所有座樓均不設4樓、13樓、14樓、24樓及34樓。
- 第1座及第2座均不設6樓及19樓；第6座、第7座、第9座及第10座均不設20樓及21樓。
- 第3座、第5座、第6座、第7座、第8座、第9座及第10座均不設2樓。
- 上表內之“-”符號代表“沒有提供”。
- 上表內填上灰色“■”之部分代表“不適用”。

# FITTINGS, FINISHES AND APPLIANCES

## 裝置、裝修物料及設備

### Schedule of Mechanical and Electrical Provisions 機電裝置數量說明表

#### Tower 8 第8座

Location 位置	Exposed Type 外露型	Non-Exposed Type 非外露型	7/F 7樓				8/F to 36/F 8樓至36樓				37/F 37樓			38/F 38樓		
			A	B	C	D	A	B	C	D	A	C	D	A	C	D
Lavatory leading from Kitchen 由廚房通往之洗手間		Fused Spur Unit/Connection Unit 接線座	1	1			1	1			1			1		
Kitchen 廚房	13A Twin Socket Outlet 13A雙位電插座		1	1	1	1	1	1	1	1	4	1	1	4	1	1
	13A Twin Socket Outlet 13A雙位電插座		1	1	-	-	1	1	-	-	-	-	-	-	-	-
	13A Single Socket Outlet 13A單位電插座		7	7	6	6	7	7	6	6	7	6	6	7	6	6
	Door Bell 門鐘		1	1	1	1	1	1	1	1	1	1	1	1	1	1
	Door Phone Handset 對講機		-	-	-	-	-	-	-	-	1	-	-	1	-	-
	20A Double Pole Switch with Pilot Lamp 20A 雙極開關掣		1	1	-	-	1	1	-	-	1	-	-	1	-	-
	Fused Spur Unit/Connection Unit 接線座		3	3	2	2	3	3	2	2	3	2	2	3	2	2
	Drain Point For Washing Machine 去水位供洗衣機		1	1	1	1	1	1	1	1	1	1	1	1	1	1
	Water Point For Washing Machine 來水位供洗衣機		1	1	1	1	1	1	1	1	1	1	1	1	1	1
Stairhood 梯屋	Lighting Switch 燈掣													2		
Flat Roof 平台	13A Weather Proof Single / Twin Socket Outlet 13A 防水單位/雙位電插座		2	2	1	1					1					
Roof 天台	13A Weather Proof Single / Twin Socket Outlet 13A 防水單位/雙位電插座													2		

#### Notes:

- The residential floors start from 7/F in all towers of the Development.
- There is no Tower 4 in the Development.
- There are no 4/F, 13/F, 14/F, 24/F and 34/F in all towers of the Development.
- There are no 6/F and 19/F in Tower 1 and Tower 2 and no 20/F and 21/F in Tower 6, Tower 7, Tower 9 and Tower 10.
- There are no 2/F in Tower 3, Tower 5, Tower 6, Tower 7, Tower 8, Tower 9 and Tower 10.
- The symbol “-” as shown in the above table denotes “Not Provided”.
- The cells shaded in grey “■” as shown in the above table denotes “Not Applicable”.

#### 備註:

- 發展項目內所有座樓之住宅由7樓開始。
- 發展項目不設第4座。
- 發展項目內所有座樓均不設4樓、13樓、14樓、24樓及34樓。
- 第1座及第2座均不設6樓及19樓；第6座、第7座、第9座及第10座均不設20樓及21樓。
- 第3座、第5座、第6座、第7座、第8座、第9座及第10座均不設2樓。
- 上表內之“-”符號代表“沒有提供”。
- 上表內填上灰色“■”之部分代表“不適用”。

# FITTINGS, FINISHES AND APPLIANCES

## 裝置、裝修物料及設備

### Appliances Schedule 設備說明表

#### Tower 9 第9座

Location 位置	Appliances 設備	Brand Name 品牌名稱	7/F 7樓				8/F to 19/F & 26/F to 35/F 8樓至19樓及26樓至35樓			
			A	B	C	D	A	B	C	D
			Model Number 產品型號							
Living Room, Dining Room & Corridor 客廳、飯廳 及走廊	Split Type Air-Conditioner 分體式冷氣機	Panasonic	Indoor Unit 室內機				Indoor Unit 室內機			
			CS- E18JD4H(2NOS.)/ CS-E10HD3EA	CS- E18JD4H(2NOS.)/ CS-E10HD3EA	CS-E23JD4H	CS-E23JD4H	CS- E18JD4H(2NOS.)/ CS-E10HD3EA	CS- E18JD4H(2NOS.)/ CS-E10HD3EA	CS-E23JD4H	CS-E23JD4H
			Outdoor Unit 室外機				Outdoor Unit 室外機			
			CU- E18JBH(2NOS.)/ CU-2E18CBPGW (Shared Outdoor Unit) (共用室外組件)	CU- E18JBH(2NOS.)/ CU-2E18CBPGW (Shared Outdoor Unit) (共用室外組件)	CU-E23JBH	CU-E23JBH	CU- E18JBH(2NOS.)/ CU-2E18CBPGW (Shared Outdoor Unit) (共用室外組件)	CU- E18JBH(2NOS.)/ CU-2E18CBPGW (Shared Outdoor Unit) (共用室外組件)	CU-E23JBH	CU-E23JBH

The vendor undertakes that if lifts and appliances of the specified brand name or model number are not installed in the Development, lifts or appliances of comparable quality will be installed.  
賣方承諾如該發展項目中沒有安裝指明的品牌名稱或產品型號的升降機或設備，便會安裝品質相若的升降機或設備。

#### Notes:

- The residential floors start from 7/F in all towers of the Development.
- There is no Tower 4 in the Development.
- There are no 4/F, 13/F, 14/F, 24/F and 34/F in all towers of the Development.
- There are no 6/F and 19/F in Tower 1 and Tower 2 and no 20/F and 21/F in Tower 6, Tower 7, Tower 9 and Tower 10.
- There are no 2/F in Tower 3, Tower 5, Tower 6, Tower 7, Tower 8, Tower 9 and Tower 10.
- The symbol “-” as shown in the above table denotes “Not Provided”.
- The cells shaded in grey “■” as shown in the above table denotes “Not Applicable”.

#### 備註：

- 發展項目內所有座樓之住宅由7樓開始。
- 發展項目不設第4座。
- 發展項目內所有座樓均不設4樓、13樓、14樓、24樓及34樓。
- 第1座及第2座均不設6樓及19樓；第6座、第7座、第9座及第10座均不設20樓及21樓。
- 第3座、第5座、第6座、第7座、第8座、第9座及第10座均不設2樓。
- 上表內之“-”符號代表“沒有提供”。
- 上表內填上灰色“■”之部分代表“不適用”。

# FITTINGS, FINISHES AND APPLIANCES

## 裝置、裝修物料及設備

### Appliances Schedule 設備說明表

#### Tower 9 第9座

Location 位置	Appliances 設備	Brand Name 品牌名稱	22/F to 25/F 22樓至25樓			36/F to 37/F 36樓至37樓		
			A	C	D	A	C	D
			Model Number 產品型號					
Living Room, Dining Room & Corridor 客廳、飯廳 及走廊	Split Type Air-Conditioner 分體式冷氣機	Panasonic	Indoor Unit 室內機			Indoor Unit 室內機		
			CS-E18JD4H(2NOS.)/ CS-E10HD3EA	CS-E23JD4H	CS-E23JD4H	CS-E18JD4H(3NOS)	CS-E23JD4H	CS-E23JD4H
			Outdoor Unit 室外機			Outdoor Unit 室外機		
			CU-E18JBH(2NOS.)/ CU-2E18CBPGW (Shared Outdoor Unit) (共用室外組件)	CU-E23JBH	CU-E23JBH	CU-E18JBH(3NOS.)	CU-E23JBH	CU-E23JBH

The vendor undertakes that if lifts and appliances of the specified brand name or model number are not installed in the Development, lifts or appliances of comparable quality will be installed.  
賣方承諾如該發展項目中沒有安裝指明的品牌名稱或產品型號的升降機或設備，便會安裝品質相若的升降機或設備。

#### Notes:

- The residential floors start from 7/F in all towers of the Development.
- There is no Tower 4 in the Development.
- There are no 4/F, 13/F, 14/F, 24/F and 34/F in all towers of the Development.
- There are no 6/F and 19/F in Tower 1 and Tower 2 and no 20/F and 21/F in Tower 6, Tower 7, Tower 9 and Tower 10.
- There are no 2/F in Tower 3, Tower 5, Tower 6, Tower 7, Tower 8, Tower 9 and Tower 10.
- The symbol “-” as shown in the above table denotes “Not Provided”.
- The cells shaded in grey “■” as shown in the above table denotes “Not Applicable”.

#### 備註：

- 發展項目內所有座樓之住宅由7樓開始。
- 發展項目不設第4座。
- 發展項目內所有座樓均不設4樓、13樓、14樓、24樓及34樓。
- 第1座及第2座均不設6樓及19樓；第6座、第7座、第9座及第10座均不設20樓及21樓。
- 第3座、第5座、第6座、第7座、第8座、第9座及第10座均不設2樓。
- 上表內之“-”符號代表“沒有提供”。
- 上表內填上灰色“■”之部分代表“不適用”。

# FITTINGS, FINISHES AND APPLIANCES

## 裝置、裝修物料及設備

### Appliances Schedule 設備說明表

#### Tower 9 第9座

Location 位置	Appliances 設備	Brand Name 品牌名稱	7/F 7樓				8/F to 19/F & 26/F to 35/F 8樓至19樓及26樓至35樓			
			A	B	C	D	A	B	C	D
			Model Number 產品型號							
Master Bedroom 主人房	Split Type Air-Conditioner 分體式冷氣機	Panasonic	Indoor Unit 室內機				Indoor Unit 室內機			
			CS-E18JD4H/ CS-E10HD3EA	CS-E18JD4H/ CS-E10HD3EA	CU-E15HD3EA		CS-E18JD4H/ CS-E10HD3EA	CS-E18JD4H/ CS-E10HD3EA	CU-E15HD3EA	
			Outdoor Unit 室外機				Outdoor Unit 室外機			
			CU-E18JBH/ CU-2E18CBPGW (Shared Outdoor Unit) (共用室外組件)	CU-E18JBH/ CU-2E18CBPGW (Shared Outdoor Unit) (共用室外組件)	CU-4E23JBE (Shared Outdoor Unit) (共用室外組件)		CU-E18JBH/ CU-2E18CBPGW (Shared Outdoor Unit) (共用室外組件)	CU-E18JBH/ CU-2E18CBPGW (Shared Outdoor Unit) (共用室外組件)	CU-4E23JBE (Shared Outdoor Unit) (共用室外組件)	
Bedroom 1 睡房1	Split Type Air-Conditioner 分體式冷氣機	Panasonic	Indoor Unit 室內機				Indoor Unit 室內機			
					CS-E15JKEW	CS-E12JD4H			CS-E15JKEW	CS-E12JD4H
			Outdoor Unit 室外機				Outdoor Unit 室外機			
					CU-4E23JBE (Shared Outdoor Unit) (共用室外組件)	CU-E12JBH			CU-4E23JBE (Shared Outdoor Unit) (共用室外組件)	CU-E12JBH

The vendor undertakes that if lifts and appliances of the specified brand name or model number are not installed in the Development, lifts or appliances of comparable quality will be installed.  
賣方承諾如該發展項目中沒有安裝指明的品牌名稱或產品型號的升降機或設備，便會安裝品質相若的升降機或設備。

#### Notes:

- The residential floors start from 7/F in all towers of the Development.
- There is no Tower 4 in the Development.
- There are no 4/F, 13/F, 14/F, 24/F and 34/F in all towers of the Development.
- There are no 6/F and 19/F in Tower 1 and Tower 2 and no 20/F and 21/F in Tower 6, Tower 7, Tower 9 and Tower 10.
- There are no 2/F in Tower 3, Tower 5, Tower 6, Tower 7, Tower 8, Tower 9 and Tower 10.
- The symbol “-” as shown in the above table denotes “Not Provided”.
- The cells shaded in grey “■” as shown in the above table denotes “Not Applicable”.

#### 備註：

- 發展項目內所有座樓之住宅由7樓開始。
- 發展項目不設第4座。
- 發展項目內所有座樓均不設4樓、13樓、14樓、24樓及34樓。
- 第1座及第2座均不設6樓及19樓；第6座、第7座、第9座及第10座均不設20樓及21樓。
- 第3座、第5座、第6座、第7座、第8座、第9座及第10座均不設2樓。
- 上表內之“-”符號代表“沒有提供”。
- 上表內填上灰色“■”之部分代表“不適用”。

# FITTINGS, FINISHES AND APPLIANCES

## 裝置、裝修物料及設備

### Appliances Schedule 設備說明表

#### Tower 9 第9座

Location 位置	Appliances 設備	Brand Name 品牌名稱	22/F to 25/F 22樓至25樓			36/F to 37/F 36樓至37樓		
			A	C	D	A	C	D
			Model Number 產品型號					
Master Bedroom 主人房	Split Type Air-Conditioner 分體式冷氣機	Panasonic	Indoor Unit 室內機			Indoor Unit 室內機		
			CS-E18JD4H/ CS-E10HD3EA	CU-E15HD3EA		CS-E23JD4H	CU-E15HD3EA	
			Outdoor Unit 室外機			Outdoor Unit 室外機		
			CU-E18JBH/ CU-2E18CBPGW (Shared Outdoor Unit) (共用室外組件)	CU-4E23JBE (Shared Outdoor Unit) (共用室外組件)		CU-E23JBH	CU-4E23JBE (Shared Outdoor Unit) (共用室外組件)	
Bedroom 1 睡房1	Split Type Air-Conditioner 分體式冷氣機	Panasonic	Indoor Unit 室內機			Indoor Unit 室內機		
				CS-E15JKEW	CS-E12JD4H	CS-E12JD4H/ CS-E18JD4H	CS-E15JKEW	CS-E12JD4H
			Outdoor Unit 室外機			Outdoor Unit 室外機		
				CU-4E23JBE (Shared Outdoor Unit) (共用室外組件)	CU-E12JBH	CU-E12JBH/ CU-E18JBH	CU-4E23JBE (Shared Outdoor Unit) (共用室外組件)	CU-E12JBH

The vendor undertakes that if lifts and appliances of the specified brand name or model number are not installed in the Development, lifts or appliances of comparable quality will be installed.  
賣方承諾如該發展項目中沒有安裝指明的品牌名稱或產品型號的升降機或設備，便會安裝品質相若的升降機或設備。

#### Notes:

- The residential floors start from 7/F in all towers of the Development.
- There is no Tower 4 in the Development.
- There are no 4/F, 13/F, 14/F, 24/F and 34/F in all towers of the Development.
- There are no 6/F and 19/F in Tower 1 and Tower 2 and no 20/F and 21/F in Tower 6, Tower 7, Tower 9 and Tower 10.
- There are no 2/F in Tower 3, Tower 5, Tower 6, Tower 7, Tower 8, Tower 9 and Tower 10.
- The symbol “-” as shown in the above table denotes “Not Provided”.
- The cells shaded in grey “■” as shown in the above table denotes “Not Applicable”.

#### 備註：

- 發展項目內所有座樓之住宅由7樓開始。
- 發展項目不設第4座。
- 發展項目內所有座樓均不設4樓、13樓、14樓、24樓及34樓。
- 第1座及第2座均不設6樓及19樓；第6座、第7座、第9座及第10座均不設20樓及21樓。
- 第3座、第5座、第6座、第7座、第8座、第9座及第10座均不設2樓。
- 上表內之“-”符號代表“沒有提供”。
- 上表內填上灰色“■”之部分代表“不適用”。

# FITTINGS, FINISHES AND APPLIANCES

## 裝置、裝修物料及設備

### Appliances Schedule 設備說明表

#### Tower 9 第9座

Location 位置	Appliances 設備	Brand Name 品牌名稱	7/F 7樓				8/F to 19/F & 26/F to 35/F 8樓至19樓及26樓至35樓			
			A	B	C	D	A	B	C	D
			Model Number 產品型號							
Kitchen 廚房	Split Type Air-Conditioner 分體式冷氣機	Panasonic	Indoor Unit 室內機				Indoor Unit 室內機			
			CS-E15HD3EA	CS-E15HD3EA	-	-	CS-E15HD3EA	CS-E15HD3EA	-	-
			Outdoor Unit 室外機				Outdoor Unit 室外機			
			CU-4E23JBE (Shared Outdoor Unit) (共用室外組件)	CU-4E23JBE (Shared Outdoor Unit) (共用室外組件)	-	-	CU-4E23JBE (Shared Outdoor Unit) (共用室外組件)	CU-4E23JBE (Shared Outdoor Unit) (共用室外組件)	-	-

The vendor undertakes that if lifts and appliances of the specified brand name or model number are not installed in the Development, lifts or appliances of comparable quality will be installed.  
賣方承諾如該發展項目中沒有安裝指明的品牌名稱或產品型號的升降機或設備，便會安裝品質相若的升降機或設備。

#### Notes:

- The residential floors start from 7/F in all towers of the Development.
- There is no Tower 4 in the Development.
- There are no 4/F, 13/F, 14/F, 24/F and 34/F in all towers of the Development.
- There are no 6/F and 19/F in Tower 1 and Tower 2 and no 20/F and 21/F in Tower 6, Tower 7, Tower 9 and Tower 10.
- There are no 2/F in Tower 3, Tower 5, Tower 6, Tower 7, Tower 8, Tower 9 and Tower 10.
- The symbol “-” as shown in the above table denotes “Not Provided”.
- The cells shaded in grey “■” as shown in the above table denotes “Not Applicable”.

#### 備註：

- 發展項目內所有座樓之住宅由7樓開始。
- 發展項目不設第4座。
- 發展項目內所有座樓均不設4樓、13樓、14樓、24樓及34樓。
- 第1座及第2座均不設6樓及19樓；第6座、第7座、第9座及第10座均不設20樓及21樓。
- 第3座、第5座、第6座、第7座、第8座、第9座及第10座均不設2樓。
- 上表內之“-”符號代表“沒有提供”。
- 上表內填上灰色“■”之部分代表“不適用”。

# FITTINGS, FINISHES AND APPLIANCES

## 裝置、裝修物料及設備

### Appliances Schedule 設備說明表

#### Tower 9 第9座

Location 位置	Appliances 設備	Brand Name 品牌名稱	22/F to 25/F 22樓至25樓			36/F to 37/F 36樓至37樓		
			A	C	D	A	C	D
			Model Number 產品型號					
Ensuite Bedroom 套房	Split Type Air-Conditioner 分體式冷氣機	Panasonic	Indoor Unit 室內機			Indoor Unit 室內機		
						CS-E18JD4H		
			Outdoor Unit 室外機			Outdoor Unit 室外機		
						CU-E18JBH		
Kitchen 廚房	Split Type Air-Conditioner 分體式冷氣機	Panasonic	Indoor Unit 室內機			Indoor Unit 室內機		
			CS-E15HD3EA	-	-	CS-E15HD3EA	-	-
			Outdoor Unit 室外機			Outdoor Unit 室外機		
			CU-4E23JBE (Shared Outdoor Unit) (共用室外組件)	-	-	CU-4E23JBE (Shared Outdoor Unit) (共用室外組件)	-	-

The vendor undertakes that if lifts and appliances of the specified brand name or model number are not installed in the Development, lifts or appliances of comparable quality will be installed.  
賣方承諾如該發展項目中沒有安裝指明的品牌名稱或產品型號的升降機或設備，便會安裝品質相若的升降機或設備。

#### Notes:

- The residential floors start from 7/F in all towers of the Development.
- There is no Tower 4 in the Development.
- There are no 4/F, 13/F, 14/F, 24/F and 34/F in all towers of the Development.
- There are no 6/F and 19/F in Tower 1 and Tower 2 and no 20/F and 21/F in Tower 6, Tower 7, Tower 9 and Tower 10.
- There are no 2/F in Tower 3, Tower 5, Tower 6, Tower 7, Tower 8, Tower 9 and Tower 10.
- The symbol “-” as shown in the above table denotes “Not Provided”.
- The cells shaded in grey “■” as shown in the above table denotes “Not Applicable”.

#### 備註：

- 發展項目內所有座樓之住宅由7樓開始。
- 發展項目不設第4座。
- 發展項目內所有座樓均不設4樓、13樓、14樓、24樓及34樓。
- 第1座及第2座均不設6樓及19樓；第6座、第7座、第9座及第10座均不設20樓及21樓。
- 第3座、第5座、第6座、第7座、第8座、第9座及第10座均不設2樓。
- 上表內之“-”符號代表“沒有提供”。
- 上表內填上灰色“■”之部分代表“不適用”。



# FITTINGS, FINISHES AND APPLIANCES

## 裝置、裝修物料及設備

### Appliances Schedule 設備說明表

#### Tower 9 第9座

Location 位置	Appliances 設備	Brand Name 品牌名稱	7/F 7樓				8/F to 19/F & 26/F to 35/F 8樓至19樓及26樓至35樓			
			A	B	C	D	A	B	C	D
			Model Number 產品型號							
Store leading from Kitchen 由廚房通往之 士多房	Split Type Air-Conditioner 分體式冷氣機	Panasonic	Indoor Unit 室內機				Indoor Unit 室內機			
			CS-E9JKEW	CS-E9JKEW			CS-E9JKEW	CS-E9JKEW		
			Outdoor Unit 室外機				Outdoor Unit 室外機			
			CU-4E23JBE (Shared Outdoor Unit) (共用室外組件)	CU-4E23JBE (Shared Outdoor Unit) (共用室外組件)			CU-4E23JBE (Shared Outdoor Unit) (共用室外組件)	CU-4E23JBE (Shared Outdoor Unit) (共用室外組件)		
Living Room, Dining Room & Corridor 客廳、飯廳及 走廊	Videophone 視像對講機	Bitron	AV2850/1	AV2850/1	AV2850/1	AV2850/1	AV2850/1	AV2850/1	AV2850/1	AV2850/1
	Door Bell 門鐘	Hager 海格	XC001	XC001	-	-	XC001	XC001	-	-

The vendor undertakes that if lifts and appliances of the specified brand name or model number are not installed in the Development, lifts or appliances of comparable quality will be installed.  
賣方承諾如該發展項目中沒有安裝指明的品牌名稱或產品型號的升降機或設備，便會安裝品質相若的升降機或設備。

#### Notes:

- The residential floors start from 7/F in all towers of the Development.
- There is no Tower 4 in the Development.
- There are no 4/F, 13/F, 14/F, 24/F and 34/F in all towers of the Development.
- There are no 6/F and 19/F in Tower 1 and Tower 2 and no 20/F and 21/F in Tower 6, Tower 7, Tower 9 and Tower 10.
- There are no 2/F in Tower 3, Tower 5, Tower 6, Tower 7, Tower 8, Tower 9 and Tower 10.
- The symbol “-” as shown in the above table denotes “Not Provided”.
- The cells shaded in grey “■” as shown in the above table denotes “Not Applicable”.

#### 備註：

- 發展項目內所有座樓之住宅由7樓開始。
- 發展項目不設第4座。
- 發展項目內所有座樓均不設4樓、13樓、14樓、24樓及34樓。
- 第1座及第2座均不設6樓及19樓；第6座、第7座、第9座及第10座均不設20樓及21樓。
- 第3座、第5座、第6座、第7座、第8座、第9座及第10座均不設2樓。
- 上表內之“-”符號代表“沒有提供”。
- 上表內填上灰色“■”之部分代表“不適用”。

# FITTINGS, FINISHES AND APPLIANCES

## 裝置、裝修物料及設備

### Appliances Schedule 設備說明表

#### Tower 9 第9座

Location 位置	Appliances 設備	Brand Name 品牌名稱	22/F to 25/F 22樓至25樓			36/F to 37/F 36樓至37樓		
			A	C	D	A	C	D
			Model Number 產品型號					
Store leading from Kitchen 由廚房通往之 士多房	Split Type Air-Conditioner 分體式冷氣機	Panasonic	Indoor Unit 室內機			Indoor Unit 室內機		
			CS-E9JKEW			CS-E9JKEW		
			Outdoor Unit 室外機			Outdoor Unit 室外機		
			CU-4E23JBE (Shared Outdoor Unit) (共用室外組件)			CU-4E23JBE (Shared Outdoor Unit) (共用室外組件)		
Living Room, Dining Room & Corridor 客廳、飯廳及 走廊	Videophone 視像對講機	Bitron	AV2850/1	AV2850/1	AV2850/1	-	-	-
	Door Bell 門鐘	Hager 海格	XC001	-	-	XC001	-	-

The vendor undertakes that if lifts and appliances of the specified brand name or model number are not installed in the Development, lifts or appliances of comparable quality will be installed.  
賣方承諾如該發展項目中沒有安裝指明的品牌名稱或產品型號的升降機或設備，便會安裝品質相若的升降機或設備。

#### Notes:

- The residential floors start from 7/F in all towers of the Development.
- There is no Tower 4 in the Development.
- There are no 4/F, 13/F, 14/F, 24/F and 34/F in all towers of the Development.
- There are no 6/F and 19/F in Tower 1 and Tower 2 and no 20/F and 21/F in Tower 6, Tower 7, Tower 9 and Tower 10.
- There are no 2/F in Tower 3, Tower 5, Tower 6, Tower 7, Tower 8, Tower 9 and Tower 10.
- The symbol “-” as shown in the above table denotes “Not Provided”.
- The cells shaded in grey “■” as shown in the above table denotes “Not Applicable”.

#### 備註：

- 發展項目內所有座樓之住宅由7樓開始。
- 發展項目不設第4座。
- 發展項目內所有座樓均不設4樓、13樓、14樓、24樓及34樓。
- 第1座及第2座均不設6樓及19樓；第6座、第7座、第9座及第10座均不設20樓及21樓。
- 第3座、第5座、第6座、第7座、第8座、第9座及第10座均不設2樓。
- 上表內之“-”符號代表“沒有提供”。
- 上表內填上灰色“■”之部分代表“不適用”。

# FITTINGS, FINISHES AND APPLIANCES

## 裝置、裝修物料及設備

### Appliances Schedule 設備說明表

#### Tower 9 第9座

Location 位置	Appliances 設備	Brand Name 品牌名稱	7/F 7樓				8/F to 19/F & 26/F to 35/F 8樓至19樓及26樓至35樓			
			A	B	C	D	A	B	C	D
			Model Number 產品型號							
Kitchen 廚房	Cooker Hood 抽油煙機	Miele 美諾	DA3190	DA3190	DA3190	DA3190	DA3190	DA3190	DA3190	DA3190
	Gas Cooking Hob 煤氣煮食爐	Miele 美諾	CS1018G CS1013G	CS1018G CS1013G	CS1018G CS1013G	CS1018G CS1013G	CS1018G CS1013G	CS1018G CS1013G	CS1018G CS1013G	CS1018G CS1013G
	Gas Water Heater 煤氣熱水爐	TGC	NJW160TFQL <sup>(1)</sup>	NJW160TFQL <sup>(1)</sup>	NJW160TFQL <sup>(2)</sup>	NJW160TFQL <sup>(2)</sup>	NJW160TFQL <sup>(1)</sup>	NJW160TFQL <sup>(1)</sup>	NJW160TFQL <sup>(2)</sup>	NJW160TFQL <sup>(2)</sup>
	Microwave Oven 微波爐	Miele 美諾	M8161-2	M8161-2	M8161-2	M8161-2	M8161-2	M8161-2	M8161-2	M8161-2
	Refrigerator 雪櫃	Siemens 西門子	KI38VA/ KU15R	KI38VA/ KU15R	KI38VA	KI38VA	KI38VA/ KU15R	KI38VA/ KU15R	KI38VA	KI38VA
	Washer/Dryer 洗衣/乾衣機	Siemens 西門子	WK16D	WK16D	WK16D	WK16D	WK16D	WK16D	WK16D	WK16D
	Exhaust Fan 抽氣扇	Xpelair	GX 6	GX 6	GX 6	GX 6	GX 6	GX 6	GX 6	GX 6

The vendor undertakes that if lifts and appliances of the specified brand name or model number are not installed in the Development, lifts or appliances of comparable quality will be installed.

賣方承諾如該發展項目中沒有安裝指明的品牌名稱或產品型號的升降機或設備，便會安裝品質相若的升降機或設備。

#### Notes:

- The residential floors start from 7/F in all towers of the Development.
- There is no Tower 4 in the Development.
- There are no 4/F, 13/F, 14/F, 24/F and 34/F in all towers of the Development.
- There are no 6/F and 19/F in Tower 1 and Tower 2 and no 20/F and 21/F in Tower 6, Tower 7, Tower 9 and Tower 10.
- There are no 2/F in Tower 3, Tower 5, Tower 6, Tower 7, Tower 8, Tower 9 and Tower 10.
- The symbol “-” as shown in the above table denotes “Not Provided”.
- The cells shaded in grey “■” as shown in the above table denotes “Not Applicable”.

(1) : The gas water heater located at A/C room & served for Lavatory leading from Kitchen, Kitchen and Bathroom

(2) : The gas water heater located at A/C room & served for Kitchen and Bathroom

(3) : The gas water heater located at A/C room & served for Lavatory leading from Kitchen and Bathroom next to Ensuite Bedroom

#### 備註：

- 發展項目內所有座樓之住宅由7樓開始。
- 發展項目不設第4座。
- 發展項目內所有座樓均不設4樓、13樓、14樓、24樓及34樓。
- 第1座及第2座均不設6樓及19樓；第6座、第7座、第9座及第10座均不設20樓及21樓。
- 第3座、第5座、第6座、第7座、第8座、第9座及第10座均不設2樓。
- 上表內之“-”符號代表“沒有提供”。
- 上表內填上灰色“■”之部分代表“不適用”。

(1) : 該款煤氣熱水爐位於冷氣機房及供應熱水給由廚房通往之洗手間、廚房和浴室

(2) : 該款煤氣熱水爐位於冷氣機房及供應熱水給廚房和浴室

(3) : 該款煤氣熱水爐位於冷氣機房及供應熱水給由廚房通往之洗手間和套房旁之浴室

# FITTINGS, FINISHES AND APPLIANCES

## 裝置、裝修物料及設備

### Appliances Schedule 設備說明表

#### Tower 9 第9座

Location 位置	Appliances 設備	Brand Name 品牌名稱	22/F to 25/F 22樓至25樓			36/F to 37/F 36樓至37樓		
			A	C	D	A	C	D
			Model Number 產品型號					
Kitchen 廚房	Cooker Hood 抽油煙機	Miele 美諾	DA3190	DA3190	DA3190	DA422-4	DA3190	DA3190
	Gas Cooking Hob 煤氣煮食爐	Miele 美諾	CS1018G CS1013G	CS1018G CS1013G	CS1018G CS1013G	CS1018G CS1013G	CS1018G CS1013G	CS1018G CS1013G
	Gas Water Heater 煤氣熱水爐	TGC	NJW160TFQL <sup>(1)</sup>	NJW160TFQL <sup>(2)</sup>	NJW160TFQL <sup>(2)</sup>	NJW220TFQL <sup>(2)</sup>	NJW160TFQL <sup>(2)</sup>	NJW160TFQL
	Microwave Oven 微波爐	Miele 美諾	M8161-2	M8161-2	M8161-2	M8161-2	M8161-2	M8161-2
	Refrigerator 雪櫃	Siemens 西門子	KI38VA/ KU15R	KI38VA	KI38VA	-	KI38VA	KI38VA
		Sub-Zero	-	-	-	ICBBI-42S	-	-
	Washer/Dryer 洗衣/乾衣機	Miele 美諾	-	-	-	WT2789i	-	-
Siemens 西門子		WK16D	WK16D	WK16D	-	WK16D	WK16D	

The vendor undertakes that if lifts and appliances of the specified brand name or model number are not installed in the Development, lifts or appliances of comparable quality will be installed.  
賣方承諾如該發展項目中沒有安裝指明的品牌名稱或產品型號的升降機或設備，便會安裝品質相若的升降機或設備。

#### Notes:

- The residential floors start from 7/F in all towers of the Development.
  - There is no Tower 4 in the Development.
  - There are no 4/F, 13/F, 14/F, 24/F and 34/F in all towers of the Development.
  - There are no 6/F and 19/F in Tower 1 and Tower 2 and no 20/F and 21/F in Tower 6, Tower 7, Tower 9 and Tower 10.
  - There are no 2/F in Tower 3, Tower 5, Tower 6, Tower 7, Tower 8, Tower 9 and Tower 10.
  - The symbol “-” as shown in the above table denotes “Not Provided”.
  - The cells shaded in grey “■” as shown in the above table denotes “Not Applicable”.
- (1): The gas water heater located at A/C room & served for Lavatory leading from Kitchen, Kitchen and Bathroom  
(2): The gas water heater located at A/C room & served for Kitchen and Bathroom  
(3): The gas water heater located at A/C room & served for Lavatory leading from Kitchen and Bathroom next to Ensuite Bedroom

#### 備註:

- 發展項目內所有座樓之住宅由7樓開始。
  - 發展項目不設第4座。
  - 發展項目內所有座樓均不設4樓、13樓、14樓、24樓及34樓。
  - 第1座及第2座均不設6樓及19樓；第6座、第7座、第9座及第10座均不設20樓及21樓。
  - 第3座、第5座、第6座、第7座、第8座、第9座及第10座均不設2樓。
  - 上表內之“-”符號代表“沒有提供”。
  - 上表內填上灰色“■”之部分代表“不適用”。
- (1): 該款煤氣熱水爐位於冷氣機房及供應熱水給由廚房通往之洗手間、廚房和浴室  
(2): 該款煤氣熱水爐位於冷氣機房及供應熱水給廚房和浴室  
(3): 該款煤氣熱水爐位於冷氣機房及供應熱水給由廚房通往之洗手間和套房旁之浴室

# FITTINGS, FINISHES AND APPLIANCES

## 裝置、裝修物料及設備

### Appliances Schedule 設備說明表

#### Tower 9 第9座

Location 位置	Appliances 設備	Brand Name 品牌名稱	7/F 7樓				8/F to 19/F & 26/F to 35/F 8樓至19樓及26樓至35樓			
			A	B	C	D	A	B	C	D
			Model Number 產品型號							
Kitchen 廚房	Induction Hob 電磁爐	Miele 美諾	CS1212	CS1212	-	-	CS1212	CS1212	-	-
	Steam Oven 電蒸爐	Miele 美諾	DGC5051	DGC5051	-	-	DGC5051	DGC5051	-	-
	Wine Cellar 酒櫃	Miele 美諾	KWT4154UG-1	KWT4154UG-1	-	-	KWT4154UG-1	KWT4154UG-1	-	-
	Door Bell 門鐘	Hager 海格	XC001	XC001	XC001	XC001	XC001	XC001	XC001	XC001

The vendor undertakes that if lifts and appliances of the specified brand name or model number are not installed in the Development, lifts or appliances of comparable quality will be installed.  
賣方承諾如該發展項目中沒有安裝指明的品牌名稱或產品型號的升降機或設備，便會安裝品質相若的升降機或設備。

#### Notes:

- The residential floors start from 7/F in all towers of the Development.
- There is no Tower 4 in the Development.
- There are no 4/F, 13/F, 14/F, 24/F and 34/F in all towers of the Development.
- There are no 6/F and 19/F in Tower 1 and Tower 2 and no 20/F and 21/F in Tower 6, Tower 7, Tower 9 and Tower 10.
- There are no 2/F in Tower 3, Tower 5, Tower 6, Tower 7, Tower 8, Tower 9 and Tower 10.
- The symbol “-” as shown in the above table denotes “Not Provided”.
- The cells shaded in grey “■” as shown in the above table denotes “Not Applicable”.

#### 備註：

- 發展項目內所有座樓之住宅由7樓開始。
- 發展項目不設第4座。
- 發展項目內所有座樓均不設4樓、13樓、14樓、24樓及34樓。
- 第1座及第2座均不設6樓及19樓；第6座、第7座、第9座及第10座均不設20樓及21樓。
- 第3座、第5座、第6座、第7座、第8座、第9座及第10座均不設2樓。
- 上表內之“-”符號代表“沒有提供”。
- 上表內填上灰色“■”之部分代表“不適用”。

# FITTINGS, FINISHES AND APPLIANCES

## 裝置、裝修物料及設備

### Appliances Schedule 設備說明表

#### Tower 9 第9座

Location 位置	Appliances 設備	Brand Name 品牌名稱	22/F to 25/F 22樓至25樓			36/F to 37/F 36樓至37樓		
			A	C	D	A	C	D
			Model Number 產品型號					
Kitchen 廚房	Exhaust Fan 抽氣扇	Xpelair	GX 6	GX 6	GX 6	GX 6	GX 6	GX 6
	Induction Hob 電磁爐	Miele 美諾	CS1212	-	-	CS1212	-	-
	Steam Oven 電蒸爐	Miele 美諾	DGC5051	-	-	DGC5051	-	-
	Wine Cellar 酒櫃	Miele 美諾	KWT4154UG-1	-	-	KWT4154UG-1	-	-
	Door Bell 門鐘	Hager 海格	XC001	XC001	XC001	XC001	XC001	XC001
	Videophone 視像對講機	Bitron	-	-	-	AV2850/1	AV2850/1	AV2850/1

The vendor undertakes that if lifts and appliances of the specified brand name or model number are not installed in the Development, lifts or appliances of comparable quality will be installed.  
賣方承諾如該發展項目中沒有安裝指明的品牌名稱或產品型號的升降機或設備，便會安裝品質相若的升降機或設備。

#### Notes:

- The residential floors start from 7/F in all towers of the Development.
- There is no Tower 4 in the Development.
- There are no 4/F, 13/F, 14/F, 24/F and 34/F in all towers of the Development.
- There are no 6/F and 19/F in Tower 1 and Tower 2 and no 20/F and 21/F in Tower 6, Tower 7, Tower 9 and Tower 10.
- There are no 2/F in Tower 3, Tower 5, Tower 6, Tower 7, Tower 8, Tower 9 and Tower 10.
- The symbol “-” as shown in the above table denotes “Not Provided”.
- The cells shaded in grey “■” as shown in the above table denotes “Not Applicable”.

#### 備註：

- 發展項目內所有座樓之住宅由7樓開始。
- 發展項目不設第4座。
- 發展項目內所有座樓均不設4樓、13樓、14樓、24樓及34樓。
- 第1座及第2座均不設6樓及19樓；第6座、第7座、第9座及第10座均不設20樓及21樓。
- 第3座、第5座、第6座、第7座、第8座、第9座及第10座均不設2樓。
- 上表內之“-”符號代表“沒有提供”。
- 上表內填上灰色“■”之部分代表“不適用”。

# FITTINGS, FINISHES AND APPLIANCES

## 裝置、裝修物料及設備

### Appliances Schedule 設備說明表

#### Tower 9 第9座

Location 位置	Appliances 設備	Brand Name 品牌名稱	7/F 7樓				8/F to 19/F & 26/F to 35/F 8樓至19樓及26樓至35樓			
			A	B	C	D	A	B	C	D
			Model Number 產品型號							
Bathroom in Master Bedroom 主人房內之浴室	10"LCD TV 10"液晶電視	JSA	TMBG10i	TMBG10i	-	-	TMBG10i	TMBG10i	-	-
	Gas Water Heater 煤氣熱水爐	TGC	NJW220TFQL	NJW220TFQL	NJW220TFQL	-	NJW220TFQL	NJW220TFQL	NJW220TFQL	-
	Exhaust Fan 抽氣扇	Xpelair	-	-	GX 6	-	-	-	GX 6	-
		Ostberg 奧斯博格	RFE 140B	RFE 140B	-	-	RFE 140A	RFE 140A	-	-
Bathroom 浴室	Gas Water Heater 煤氣熱水爐	TGC	NJW160TFQL <sup>(1)</sup>	NJW160TFQL <sup>(1)</sup>	NJW160TFQL <sup>(2)</sup>	NJW160TFQL <sup>(2)</sup>	NJW160TFQL <sup>(1)</sup>	NJW160TFQL <sup>(1)</sup>	NJW160TFQL <sup>(2)</sup>	NJW160TFQL <sup>(2)</sup>
	Exhaust Fan 抽氣扇	Xpelair	-	-	-	GX 6	-	-	-	GX 6
		Ostberg 奧斯博格	RFE 140B	RFE 140B	RFE 140A	-	RFE 140B	RFE 140B	RFE 140A	-

The vendor undertakes that if lifts and appliances of the specified brand name or model number are not installed in the Development, lifts or appliances of comparable quality will be installed.

賣方承諾如該發展項目中沒有安裝指明的品牌名稱或產品型號的升降機或設備，便會安裝品質相若的升降機或設備。

#### Notes:

- The residential floors start from 7/F in all towers of the Development.
  - There is no Tower 4 in the Development.
  - There are no 4/F, 13/F, 14/F, 24/F and 34/F in all towers of the Development.
  - There are no 6/F and 19/F in Tower 1 and Tower 2 and no 20/F and 21/F in Tower 6, Tower 7, Tower 9 and Tower 10.
  - There are no 2/F in Tower 3, Tower 5, Tower 6, Tower 7, Tower 8, Tower 9 and Tower 10.
  - The symbol "-" as shown in the above table denotes "Not Provided".
  - The cells shaded in grey "■" as shown in the above table denotes "Not Applicable".
- (1) : The gas water heater located at A/C room & served for Lavatory leading from Kitchen, Kitchen and Bathroom  
 (2) : The gas water heater located at A/C room & served for Kitchen and Bathroom  
 (3) : The gas water heater located at A/C room & served for Lavatory leading from Kitchen and Bathroom next to Ensuite Bedroom

#### 備註：

- 發展項目內所有座樓之住宅由7樓開始。
  - 發展項目不設第4座。
  - 發展項目內所有座樓均不設4樓、13樓、14樓、24樓及34樓。
  - 第1座及第2座均不設6樓及19樓；第6座、第7座、第9座及第10座均不設20樓及21樓。
  - 第3座、第5座、第6座、第7座、第8座、第9座及第10座均不設2樓。
  - 上表內之“-”符號代表“沒有提供”。
  - 上表內填上灰色“■”之部分代表“不適用”。
- (1) : 該款煤氣熱水爐位於冷氣機房及供應熱水給由廚房通往之洗手間、廚房和浴室  
 (2) : 該款煤氣熱水爐位於冷氣機房及供應熱水給廚房和浴室  
 (3) : 該款煤氣熱水爐位於冷氣機房及供應熱水給由廚房通往之洗手間和套房旁之浴室

# FITTINGS, FINISHES AND APPLIANCES

## 裝置、裝修物料及設備

### Appliances Schedule 設備說明表

#### Tower 9 第9座

Location 位置	Appliances 設備	Brand Name 品牌名稱	22/F to 25/F 22樓至25樓			36/F to 37/F 36樓至37樓		
			A	C	D	A	C	D
			Model Number 產品型號					
Bathroom in Master Bedroom 主人房內之浴室	15"LCD TV 15"液晶體電視	JSA	-	-	-	TMBG15	-	-
	10"LCD TV 10"液晶體電視	JSA	TMBG10i	-	-	-	-	-
	Ceiling Speaker 揚聲器	KEF	-	-	-	2 x Cs130.2FS	-	-
	Gas Water Heater 煤氣熱水爐	TGC	NJW220TFQL	NJW220TFQL	-	NJW220TFQL	NJW220TFQL	-
	Exhaust Fan 抽氣扇	Xpelair	-	GX 6	-	-	GX 6	-
Ostberg 奧斯博格		RFE 140A	-	-	-	RFE 200B	-	-

The vendor undertakes that if lifts and appliances of the specified brand name or model number are not installed in the Development, lifts or appliances of comparable quality will be installed.  
賣方承諾如該發展項目中沒有安裝指明的品牌名稱或產品型號的升降機或設備，便會安裝品質相若的升降機或設備。

#### Notes:

- The residential floors start from 7/F in all towers of the Development.
  - There is no Tower 4 in the Development.
  - There are no 4/F, 13/F, 14/F, 24/F and 34/F in all towers of the Development.
  - There are no 6/F and 19/F in Tower 1 and Tower 2 and no 20/F and 21/F in Tower 6, Tower 7, Tower 9 and Tower 10.
  - There are no 2/F in Tower 3, Tower 5, Tower 6, Tower 7, Tower 8, Tower 9 and Tower 10.
  - The symbol "-" as shown in the above table denotes "Not Provided".
  - The cells shaded in grey "■" as shown in the above table denotes "Not Applicable".
- (1): The gas water heater located at A/C room & served for Lavatory leading from Kitchen, Kitchen and Bathroom  
(2): The gas water heater located at A/C room & served for Kitchen and Bathroom  
(3): The gas water heater located at A/C room & served for Lavatory leading from Kitchen and Bathroom next to Ensuite Bedroom

#### 備註:

- 發展項目內所有座樓之住宅由7樓開始。
  - 發展項目不設第4座。
  - 發展項目內所有座樓均不設4樓、13樓、14樓、24樓及34樓。
  - 第1座及第2座均不設6樓及19樓；第6座、第7座、第9座及第10座均不設20樓及21樓。
  - 第3座、第5座、第6座、第7座、第8座、第9座及第10座均不設2樓。
  - 上表內之“-”符號代表“沒有提供”。
  - 上表內填上灰色“■”之部分代表“不適用”。
- (1): 該款煤氣熱水爐位於冷氣機房及供應熱水給由廚房通往之洗手間、廚房和浴室  
(2): 該款煤氣熱水爐位於冷氣機房及供應熱水給廚房和浴室  
(3): 該款煤氣熱水爐位於冷氣機房及供應熱水給由廚房通往之洗手間和套房旁之浴室



# FITTINGS, FINISHES AND APPLIANCES

## 裝置、裝修物料及設備

### Appliances Schedule 設備說明表

#### Tower 9 第9座

Location 位置	Appliances 設備	Brand Name 品牌名稱	7/F 7樓				8/F to 19/F & 26/F to 35/F 8樓至19樓及26樓至35樓			
			A	B	C	D	A	B	C	D
			Model Number 產品型號							
Lavatory leading from Kitchen 由廚房通往之 洗手間	Gas Water Heater 煤氣熱水爐	TGC	NJW160TFQL <sup>(1)</sup>	NJW160TFQL <sup>(1)</sup>			NJW160TFQL <sup>(1)</sup>	NJW160TFQL <sup>(1)</sup>		
	Exhaust Fan 抽氣扇	Xpelair	GX 6	GX 6			GX 6	GX 6		

The vendor undertakes that if lifts and appliances of the specified brand name or model number are not installed in the Development, lifts or appliances of comparable quality will be installed.  
賣方承諾如該發展項目中沒有安裝指明的品牌名稱或產品型號的升降機或設備，便會安裝品質相若的升降機或設備。

#### Notes:

- The residential floors start from 7/F in all towers of the Development.
  - There is no Tower 4 in the Development.
  - There are no 4/F, 13/F, 14/F, 24/F and 34/F in all towers of the Development.
  - There are no 6/F and 19/F in Tower 1 and Tower 2 and no 20/F and 21/F in Tower 6, Tower 7, Tower 9 and Tower 10.
  - There are no 2/F in Tower 3, Tower 5, Tower 6, Tower 7, Tower 8, Tower 9 and Tower 10.
  - The symbol “-” as shown in the above table denotes “Not Provided”.
  - The cells shaded in grey “■” as shown in the above table denotes “Not Applicable”.
- (1) : The gas water heater located at A/C room & served for Lavatory leading from Kitchen, Kitchen and Bathroom  
(2) : The gas water heater located at A/C room & served for Kitchen and Bathroom  
(3) : The gas water heater located at A/C room & served for Lavatory leading from Kitchen and Bathroom next to Ensuite Bedroom

#### 備註：

- 發展項目內所有座樓之住宅由7樓開始。
  - 發展項目不設第4座。
  - 發展項目內所有座樓均不設4樓、13樓、14樓、24樓及34樓。
  - 第1座及第2座均不設6樓及19樓；第6座、第7座、第9座及第10座均不設20樓及21樓。
  - 第3座、第5座、第6座、第7座、第8座、第9座及第10座均不設2樓。
  - 上表內之“-”符號代表“沒有提供”。
  - 上表內填上灰色“■”之部分代表“不適用”。
- (1) : 該款煤氣熱水爐位於冷氣機房及供應熱水給由廚房通往之洗手間、廚房和浴室  
(2) : 該款煤氣熱水爐位於冷氣機房及供應熱水給廚房和浴室  
(3) : 該款煤氣熱水爐位於冷氣機房及供應熱水給由廚房通往之洗手間和套房旁之浴室

# FITTINGS, FINISHES AND APPLIANCES

## 裝置、裝修物料及設備

### Appliances Schedule 設備說明表

#### Tower 9 第9座

Location 位置	Appliances 設備	Brand Name 品牌名稱	22/F to 25/F 22樓至25樓			36/F to 37/F 36樓至37樓		
			A	C	D	A	C	D
			Model Number 產品型號					
Bathroom 浴室	Gas Water Heater 煤氣熱水爐	TGC	NJW160TFQL <sup>(1)</sup>	NJW160TFQL <sup>(2)</sup>	NJW160TFQL <sup>(2)</sup>	NJW220TFQL <sup>(2)</sup>	NJW160TFQL <sup>(2)</sup>	NJW160TFQL
	Exhaust Fan 抽氣扇	Xpelair	-	-	GX 6	-	-	GX 6
		Ostberg 奧斯博格	RFE 140B	RFE 140A	-	RFE 140A	RFE 140A	-
Bathroom next to Ensuite Bedroom 套房旁之浴室	Gas Water Heater 煤氣熱水爐	TGC				NJW220TFQL <sup>(3)</sup>		
	Exhaust Fan 抽氣扇	Ostberg 奧斯博格				RFE 140A		
Lavatory leading from Kitchen 由廚房通往之 洗手間	Gas Water Heater 煤氣熱水爐	TGC	NJW160TFQL <sup>(1)</sup>			NJW220TFQL <sup>(3)</sup>		
	Exhaust Fan 抽氣扇	Xpelair	GX 6			GX 6		

The vendor undertakes that if lifts and appliances of the specified brand name or model number are not installed in the Development, lifts or appliances of comparable quality will be installed.  
賣方承諾如該發展項目中沒有安裝指明的品牌名稱或產品型號的升降機或設備，便會安裝品質相若的升降機或設備。

#### Notes:

- The residential floors start from 7/F in all towers of the Development.
  - There is no Tower 4 in the Development.
  - There are no 4/F, 13/F, 14/F, 24/F and 34/F in all towers of the Development.
  - There are no 6/F and 19/F in Tower 1 and Tower 2 and no 20/F and 21/F in Tower 6, Tower 7, Tower 9 and Tower 10.
  - There are no 2/F in Tower 3, Tower 5, Tower 6, Tower 7, Tower 8, Tower 9 and Tower 10.
  - The symbol “-” as shown in the above table denotes “Not Provided”.
  - The cells shaded in grey “■” as shown in the above table denotes “Not Applicable”.
- (1): The gas water heater located at A/C room & served for Lavatory leading from Kitchen, Kitchen and Bathroom  
(2): The gas water heater located at A/C room & served for Kitchen and Bathroom  
(3): The gas water heater located at A/C room & served for Lavatory leading from Kitchen and Bathroom next to Ensuite Bedroom

#### 備註:

- 發展項目內所有座樓之住宅由7樓開始。
  - 發展項目不設第4座。
  - 發展項目內所有座樓均不設4樓、13樓、14樓、24樓及34樓。
  - 第1座及第2座均不設6樓及19樓；第6座、第7座、第9座及第10座均不設20樓及21樓。
  - 第3座、第5座、第6座、第7座、第8座、第9座及第10座均不設2樓。
  - 上表內之“-”符號代表“沒有提供”。
  - 上表內填上灰色“■”之部分代表“不適用”。
- (1): 該款煤氣熱水爐位於冷氣機房及供應熱水給由廚房通往之洗手間、廚房和浴室  
(2): 該款煤氣熱水爐位於冷氣機房及供應熱水給廚房和浴室  
(3): 該款煤氣熱水爐位於冷氣機房及供應熱水給由廚房通往之洗手間和套房旁之浴室

# FITTINGS, FINISHES AND APPLIANCES

## 裝置、裝修物料及設備

### Schedule of Mechanical and Electrical Provisions 機電裝置數量說明表

#### Tower 9 第9座

Location 位置	Exposed Type 外露型	Non-Exposed Type 非外露型	7/F 7樓				8/F to 19/F & 26/F to 35/F 8樓至19樓及 26樓至35樓				22/F to 25/F 22樓至25樓			36/F 36樓			37/F 37樓			
			A	B	C	D	A	B	C	D	A	C	D	A	C	D	A	C	D	
Living Room, Dining Room & Corridor 客廳、飯廳及 走廊	TV/ FM Outlet 電視/電台天線插座		3	3	2	2	3	3	2	2	3	2	2	2	2	2	2	2	2	
	Telephone Outlet 電話插座		2	2	1	1	2	2	1	2	2	1	2	2	1	2	2	1	2	
	13A Twin Socket Outlet 13A雙位電插座		5	5	2	2	6	6	4	4	6	4	4	5	4	4	5	4	4	
	13A Single Socket Outlet 13A單位電插座		4	4	5	5	3	3	5	5	3	5	5	5	5	5	4	5	5	
	Lighting Switch 燈掣		7	7	6	6	6	6	5	5	6	5	5	11	5	5	9	5	5	
		Door Bell 門鐘		1	1	-	-	1	1	-	-	1	-	-	1	-	-	1	-	-
		Door Phone Handset 對講機		1	1	1	1	1	1	1	1	1	1	1	-	1	1	-	1	1
		20A Double Pole Switch with Pilot Lamp 20A 雙極開關掣		2	2	2	2	2	2	2	2	2	2	2	3	2	2	3	2	2
	Fused Spur Unit/Connection Unit 接線座		1	1	-	-	1	1	-	-	1	-	-	1	-	-	1	-	-	
Master Bedroom 主人房	TV/ FM Outlet 電視/電台天線插座		2	2	1		2	2	1		2	1		2	1		2	1		
	Telephone Outlet 電話插座		2	2	1		2	2	1		2	1		2	1		2	1		
	13A Twin Socket Outlet 13A雙位電插座		3	3	2		3	3	2		3	2		4	2		4	2		
	13A Single Socket Outlet 13A單位電插座		1	1	1		1	1	1		1	1		2	1		2	1		
	Lighting Switch 燈掣		4	4	2		3	3	2		3	2		3	2		3	2		
	20A Double Pole Switch with Pilot Lamp 20A 雙極開關掣		1	1	1		1	1	1		1	1		2	1		2	1		

#### Notes:

- The residential floors start from 7/F in all towers of the Development.
- There is no Tower 4 in the Development.
- There are no 4/F, 13/F, 14/F, 24/F and 34/F in all towers of the Development.
- There are no 6/F and 19/F in Tower 1 and Tower 2 and no 20/F and 21/F in Tower 6, Tower 7, Tower 9 and Tower 10.
- There are no 2/F in Tower 3, Tower 5, Tower 6, Tower 7, Tower 8, Tower 9 and Tower 10.
- The symbol “-” as shown in the above table denotes “Not Provided”.
- The cells shaded in grey “■” as shown in the above table denotes “Not Applicable”.

#### 備註:

- 發展項目內所有座樓之住宅由7樓開始。
- 發展項目不設第4座。
- 發展項目內所有座樓均不設4樓、13樓、14樓、24樓及34樓。
- 第1座及第2座均不設6樓及19樓；第6座、第7座、第9座及第10座均不設20樓及21樓。
- 第3座、第5座、第6座、第7座、第8座、第9座及第10座均不設2樓。
- 上表內之“-”符號代表“沒有提供”。
- 上表內填上灰色“■”之部分代表“不適用”。

# FITTINGS, FINISHES AND APPLIANCES

## 裝置、裝修物料及設備

### Schedule of Mechanical and Electrical Provisions 機電裝置數量說明表

#### Tower 9 第9座

Location 位置	Exposed Type 外露型	Non-Exposed Type 非外露型	7/F 7樓				8/F to 19/F & 26/F to 35/F 8樓至19樓及 26樓至35樓				22/F to 25/F 22樓至25樓			36/F 36樓			37/F 37樓		
			A	B	C	D	A	B	C	D	A	C	D	A	C	D	A	C	D
Bedroom 1 睡房1	TV/ FM Outlet 電視/電台天線插座				1	1			1	1		1	1	2	1	1	2	1	1
	Telephone Outlet 電話插座				1	1			1	1		1	1	2	1	1	2	1	1
	13A Twin Socket Outlet 13A雙位電插座				2	2			2	2		2	2	2	2	2	2	2	2
	13A Single Socket Outlet 13A單位電插座				-	1			-	1		-	1	1	-	1	1	-	1
	Lighting Switch 燈掣				1	1			1	1		1	1	2	1	1	2	1	1
Ensuite Bedroom 套房	TV/ FM Outlet 電視/電台天線插座													2			2		
	Telephone Outlet 電話插座													1			1		
	13A Twin Socket Outlet 13A雙位電插座													4			4		
	13A Single Socket Outlet 13A單位電插座													2			2		
	Lighting Switch 燈掣													3			2		

#### Notes:

- The residential floors start from 7/F in all towers of the Development.
- There is no Tower 4 in the Development.
- There are no 4/F, 13/F, 14/F, 24/F and 34/F in all towers of the Development.
- There are no 6/F and 19/F in Tower 1 and Tower 2 and no 20/F and 21/F in Tower 6, Tower 7, Tower 9 and Tower 10.
- There are no 2/F in Tower 3, Tower 5, Tower 6, Tower 7, Tower 8, Tower 9 and Tower 10.
- The symbol “-” as shown in the above table denotes “Not Provided”.
- The cells shaded in grey “■” as shown in the above table denotes “Not Applicable”.

#### 備註：

- 發展項目內所有座樓之住宅由7樓開始。
- 發展項目不設第4座。
- 發展項目內所有座樓均不設4樓、13樓、14樓、24樓及34樓。
- 第1座及第2座均不設6樓及19樓；第6座、第7座、第9座及第10座均不設20樓及21樓。
- 第3座、第5座、第6座、第7座、第8座、第9座及第10座均不設2樓。
- 上表內之“-”符號代表“沒有提供”。
- 上表內填上灰色“■”之部分代表“不適用”。

# FITTINGS, FINISHES AND APPLIANCES

## 裝置、裝修物料及設備

### Schedule of Mechanical and Electrical Provisions 機電裝置數量說明表

#### Tower 9 第9座

Location 位置	Exposed Type 外露型	Non-Exposed Type 非外露型	7/F 7樓				8/F to 19/F & 26/F to 35/F 8樓至19樓及 26樓至35樓				22/F to 25/F 22樓至25樓			36/F 36樓			37/F 37樓		
			A	B	C	D	A	B	C	D	A	C	D	A	C	D	A	C	D
Store leading from Kitchen 由廚房通往之 士多房	TV/ FM Outlet 電視/電台天線插座		1	1			1	1			1			1			1		
	Telephone Outlet 電話插座		-	-			-	-			-			1			1		
	13A Twin Socket Outlet 13A雙位電插座		1	1			1	1			1			1			1		
	Lighting Switch 燈掣		1	1			1	1			1			2			2		
	20A Double Pole Switch with Pilot Lamp 20A 雙極開關掣		1	1			1	1			1			1			1		
Store near to Living Room 鄰近客廳之 士多房	13A Single Socket Outlet 13A單位電插座												1			1			
Bathroom in Master Bedroom 主人房內之浴室	TV/ FM Outlet 電視/電台天線插座		1	1	1		1	1	1		1	1		1	1		1	1	
	13A Single Socket Outlet 13A單位電插座		3	3	2		3	3	2		3	2		3	2		3	2	
	Fused Spur Unit/Connection Unit 接線座		1	1	1		1	1	1		1	1		1	1		1	1	
Bathroom 浴室	TV/ FM Outlet 電視/電台天線插座		-	-	-	1	-	-	-	1	-	-	1	-	-	1	-	-	1
	13A Single Socket Outlet 13A單位電插座		1	1	1	2	1	1	1	2	1	1	2	1	1	2	1	1	2
	Fused Spur Unit/Connection Unit 接線座		1	1	1	1	1	1	1	1	1	1	1	1	1	1	1	1	1
Bathroom next to Ensuite Bedroom 套房旁之浴室	13A Single Socket Outlet 13A單位電插座													1			1		
	Fused Spur Unit/Connection Unit 接線座													1			1		

#### Notes:

- The residential floors start from 7/F in all towers of the Development.
- There is no Tower 4 in the Development.
- There are no 4/F, 13/F, 14/F, 24/F and 34/F in all towers of the Development.
- There are no 6/F and 19/F in Tower 1 and Tower 2 and no 20/F and 21/F in Tower 6, Tower 7, Tower 9 and Tower 10.
- There are no 2/F in Tower 3, Tower 5, Tower 6, Tower 7, Tower 8, Tower 9 and Tower 10.
- The symbol “-” as shown in the above table denotes “Not Provided”.
- The cells shaded in grey “■” as shown in the above table denotes “Not Applicable”.

#### 備註:

- 發展項目內所有座樓之住宅由7樓開始。
- 發展項目不設第4座。
- 發展項目內所有座樓均不設4樓、13樓、14樓、24樓及34樓。
- 第1座及第2座均不設6樓及19樓；第6座、第7座、第9座及第10座均不設20樓及21樓。
- 第3座、第5座、第6座、第7座、第8座、第9座及第10座均不設2樓。
- 上表內之“-”符號代表“沒有提供”。
- 上表內填上灰色“■”之部分代表“不適用”。

# FITTINGS, FINISHES AND APPLIANCES

## 裝置、裝修物料及設備

### Schedule of Mechanical and Electrical Provisions 機電裝置數量說明表

#### Tower 9 第9座

Location 位置	Exposed Type 外露型	Non-Exposed Type 非外露型	7/F 7樓				8/F to 19/F & 26/F to 35/F 8樓至19樓及 26樓至35樓				22/F to 25/F 22樓至25樓			36/F 36樓			37/F 37樓		
			A	B	C	D	A	B	C	D	A	C	D	A	C	D	A	C	D
Lavatory leading from Kitchen 由廚房通往之 洗手間		Fused Spur Unit/Connection Unit 接線座	1	1			1	1			1			1			1		
Kitchen 廚房	13A Twin Socket Outlet 13A雙位電插座		1	1	1	1	1	1	1	1	1	1	1	4	1	1	4	1	1
	13A Twin Socket Outlet 13A雙位電插座		1	1	-	-	1	1	-	-	1	-	-	-	-	-	-	-	-
	13A Single Socket Outlet 13A單位電插座		7	7	6	6	7	7	6	6	7	6	6	7	6	6	7	6	6
	Door Bell 門鐘		1	1	1	1	1	1	1	1	1	1	1	1	1	1	1	1	1
	Door Phone Handset 對講機		-	-	-	-	-	-	-	-	-	-	-	1	-	-	1	-	-
	20A Double Pole Switch with Pilot Lamp 20A 雙極開關掣		1	1	-	-	1	1	-	-	1	-	-	1	-	-	1	-	-
	Fused Spur Unit/Connection Unit 接線座		3	3	2	2	3	3	2	2	3	2	2	3	2	2	3	2	2
	Drain Point For Washing Machine 去水位供洗衣機		1	1	1	1	1	1	1	1	1	1	1	1	1	1	1	1	1
	Water Point For Washing Machine 來水位供洗衣機		1	1	1	1	1	1	1	1	1	1	1	1	1	1	1	1	1
Stairhood 梯屋	Lighting Switch 燈掣																2		
Flat Roof 平台	13A Weather Proof Single / Twin Socket Outlet 13A 防水單位/雙位電插座		2	2	1	1								1					
Roof 天台	13A Weather Proof Single / Twin Socket Outlet 13A 防水單位/雙位電插座																2	-	-

#### Notes:

- The residential floors start from 7/F in all towers of the Development.
- There is no Tower 4 in the Development.
- There are no 4/F, 13/F, 14/F, 24/F and 34/F in all towers of the Development.
- There are no 6/F and 19/F in Tower 1 and Tower 2 and no 20/F and 21/F in Tower 6, Tower 7, Tower 9 and Tower 10.
- There are no 2/F in Tower 3, Tower 5, Tower 6, Tower 7, Tower 8, Tower 9 and Tower 10.
- The symbol “-” as shown in the above table denotes “Not Provided”.
- The cells shaded in grey “■” as shown in the above table denotes “Not Applicable”.

#### 備註:

- 發展項目內所有座樓之住宅由7樓開始。
- 發展項目不設第4座。
- 發展項目內所有座樓均不設4樓、13樓、14樓、24樓及34樓。
- 第1座及第2座均不設6樓及19樓；第6座、第7座、第9座及第10座均不設20樓及21樓。
- 第3座、第5座、第6座、第7座、第8座、第9座及第10座均不設2樓。
- 上表內之“-”符號代表“沒有提供”。
- 上表內填上灰色“■”之部分代表“不適用”。

# FITTINGS, FINISHES AND APPLIANCES

## 裝置、裝修物料及設備

### Appliances Schedule 設備說明表

#### Tower 10 第10座

Location 位置	Appliances 設備	Brand Name 品牌名稱	7/F 7樓				8/F to 19/F & 26/F to 35/F 8樓至19樓及26樓至35樓			
			A	B	C	D	A	B	C	D
			Model Number 產品型號							
Living Room, Dining Room & Corridor 客廳、飯廳 及走廊	Split Type Air-Conditioner 分體式冷氣機	Panasonic	Indoor Unit 室內機				Indoor Unit 室內機			
			CS- E18JD4H(2NOS.)/ CS-E10HD3EA	CS-E18JD4H/ CS-E23JD4H CS-E10HD3EA	CS-E23JD4H	CS-E23JD4H	CS- E18JD4H(2NOS.)/ CS-E10HD3EA	CS- E18JD4H(2NOS.)/ CS-E10HD3EA	CS-E23JD4H	CS-E23JD4H
			Outdoor Unit 室外機				Outdoor Unit 室外機			
			CU- E18JBH(2NOS.)/ CU-2E18CBPGW (Shared Outdoor Unit) (共用室外組件)	CU-E18JBH/ CU-E23JBH/ CU-2E18CBPGW (Shared Outdoor Unit) (共用室外組件)	CU-E23JBH	CU-E23JBH	CU- E18JBH(2NOS.)/ CU-2E18CBPGW (Shared Outdoor Unit) (共用室外組件)	CU- E18JBH(2NOS.)/ CU-2E18CBPGW (Shared Outdoor Unit) (共用室外組件)	CU-E23JBH	CU-E23JBH

The vendor undertakes that if lifts and appliances of the specified brand name or model number are not installed in the Development, lifts or appliances of comparable quality will be installed.  
賣方承諾如該發展項目中沒有安裝指明的品牌名稱或產品型號的升降機或設備，便會安裝品質相若的升降機或設備。

#### Notes:

- The residential floors start from 7/F in all towers of the Development.
- There is no Tower 4 in the Development.
- There are no 4/F, 13/F, 14/F, 24/F and 34/F in all towers of the Development.
- There are no 6/F and 19/F in Tower 1 and Tower 2 and no 20/F and 21/F in Tower 6, Tower 7, Tower 9 and Tower 10.
- There are no 2/F in Tower 3, Tower 5, Tower 6, Tower 7, Tower 8, Tower 9 and Tower 10.
- The symbol “-” as shown in the above table denotes “Not Provided”.
- The cells shaded in grey “■” as shown in the above table denotes “Not Applicable”.

#### 備註：

- 發展項目內所有座樓之住宅由7樓開始。
- 發展項目不設第4座。
- 發展項目內所有座樓均不設4樓、13樓、14樓、24樓及34樓。
- 第1座及第2座均不設6樓及19樓；第6座、第7座、第9座及第10座均不設20樓及21樓。
- 第3座、第5座、第6座、第7座、第8座、第9座及第10座均不設2樓。
- 上表內之“-”符號代表“沒有提供”。
- 上表內填上灰色“■”之部分代表“不適用”。

# FITTINGS, FINISHES AND APPLIANCES

## 裝置、裝修物料及設備

### Appliances Schedule 設備說明表

#### Tower 10 第10座

Location 位置	Appliances 設備	Brand Name 品牌名稱	22/F to 25/F 22樓至25樓			36/F to 37/F 36樓至37樓		
			B	C	D	A	C	D
			Model Number 產品型號					
Living Room, Dining Room & Corridor 客廳、飯廳 及走廊	Split Type Air-Conditioner 分體式冷氣機	Panasonic	Indoor Unit 室內機			Indoor Unit 室內機		
			CS-E18JD4H(2NOS.)/ CS-E10HD3EA	CS-E23JD4H	CS-E23JD4H	CS-E18JD4H(3NOS)	CS-E23JD4H	CS-E23JD4H
			Outdoor Unit 室外機			Outdoor Unit 室外機		
			CU-E18JBH(2NOS.)/ CU-2E18CBPGW (Shared Outdoor Unit) (共用室外組件)	CU-E23JBH	CU-E23JBH	CU-E18JBH(3NOS.)	CU-E23JBH	CU-E23JBH

The vendor undertakes that if lifts and appliances of the specified brand name or model number are not installed in the Development, lifts or appliances of comparable quality will be installed.  
賣方承諾如該發展項目中沒有安裝指明的品牌名稱或產品型號的升降機或設備，便會安裝品質相若的升降機或設備。

#### Notes:

- The residential floors start from 7/F in all towers of the Development.
- There is no Tower 4 in the Development.
- There are no 4/F, 13/F, 14/F, 24/F and 34/F in all towers of the Development.
- There are no 6/F and 19/F in Tower 1 and Tower 2 and no 20/F and 21/F in Tower 6, Tower 7, Tower 9 and Tower 10.
- There are no 2/F in Tower 3, Tower 5, Tower 6, Tower 7, Tower 8, Tower 9 and Tower 10.
- The symbol “-” as shown in the above table denotes “Not Provided”.
- The cells shaded in grey “■” as shown in the above table denotes “Not Applicable”.

#### 備註：

- 發展項目內所有座樓之住宅由7樓開始。
- 發展項目不設第4座。
- 發展項目內所有座樓均不設4樓、13樓、14樓、24樓及34樓。
- 第1座及第2座均不設6樓及19樓；第6座、第7座、第9座及第10座均不設20樓及21樓。
- 第3座、第5座、第6座、第7座、第8座、第9座及第10座均不設2樓。
- 上表內之“-”符號代表“沒有提供”。
- 上表內填上灰色“■”之部分代表“不適用”。



# FITTINGS, FINISHES AND APPLIANCES

## 裝置、裝修物料及設備

### Appliances Schedule 設備說明表

#### Tower 10 第10座

Location 位置	Appliances 設備	Brand Name 品牌名稱	7/F 7樓				8/F to 19/F & 26/F to 35/F 8樓至19樓及26樓至35樓			
			A	B	C	D	A	B	C	D
			Model Number 產品型號							
Master Bedroom 主人房	Split Type Air-Conditioner 分體式冷氣機	Panasonic	Indoor Unit 室內機				Indoor Unit 室內機			
			CS-E18JD4H/ CS-E10HD3EA	CS-E18JD4H/ CS-E10HD3EA			CS-E18JD4H/ CS-E10HD3EA	CS-E18JD4H/ CS-E10HD3EA		
			Outdoor Unit 室外機				Outdoor Unit 室外機			
			CU-E18JBH/ CU-2E18CBPGW (Shared Outdoor Unit) (共用室外組件)	CU-E18JBH/ CU-2E18CBPGW (Shared Outdoor Unit) (共用室外組件)			CU-E18JBH/ CU-2E18CBPGW (Shared Outdoor Unit) (共用室外組件)	CU-E18JBH/ CU-2E18CBPGW (Shared Outdoor Unit) (共用室外組件)		
Bedroom 1 睡房 1	Split Type Air-Conditioner 分體式冷氣機	Panasonic	Indoor Unit 室內機				Indoor Unit 室內機			
					CS-E12JD4H	CS-E12JD4H			CS-E12JD4H	CS-E12JD4H
			Outdoor Unit 室外機				Outdoor Unit 室外機			
					CU-E12JBH	CU-E12JBH			CU-E12JBH	CU-E12JBH

The vendor undertakes that if lifts and appliances of the specified brand name or model number are not installed in the Development, lifts or appliances of comparable quality will be installed.  
賣方承諾如該發展項目中沒有安裝指明的品牌名稱或產品型號的升降機或設備，便會安裝品質相若的升降機或設備。

#### Notes:

- The residential floors start from 7/F in all towers of the Development.
- There is no Tower 4 in the Development.
- There are no 4/F, 13/F, 14/F, 24/F and 34/F in all towers of the Development.
- There are no 6/F and 19/F in Tower 1 and Tower 2 and no 20/F and 21/F in Tower 6, Tower 7, Tower 9 and Tower 10.
- There are no 2/F in Tower 3, Tower 5, Tower 6, Tower 7, Tower 8, Tower 9 and Tower 10.
- The symbol “-” as shown in the above table denotes “Not Provided”.
- The cells shaded in grey “■” as shown in the above table denotes “Not Applicable”.

#### 備註：

- 發展項目內所有座樓之住宅由7樓開始。
- 發展項目不設第4座。
- 發展項目內所有座樓均不設4樓、13樓、14樓、24樓及34樓。
- 第1座及第2座均不設6樓及19樓；第6座、第7座、第9座及第10座均不設20樓及21樓。
- 第3座、第5座、第6座、第7座、第8座、第9座及第10座均不設2樓。
- 上表內之“-”符號代表“沒有提供”。
- 上表內填上灰色“■”之部分代表“不適用”。

# FITTINGS, FINISHES AND APPLIANCES

## 裝置、裝修物料及設備

### Appliances Schedule 設備說明表

#### Tower 10 第10座

Location 位置	Appliances 設備	Brand Name 品牌名稱	22/F to 25/F 22樓至25樓			36/F to 37/F 36樓至37樓		
			B	C	D	A	C	D
			Model Number 產品型號					
Master Bedroom 主人房	Split Type Air-Conditioner 分體式冷氣機	Panasonic	Indoor Unit 室內機			Indoor Unit 室內機		
			CS-E18JD4H/ CS-E10HD3EA			CS-E23JD4H		
			Outdoor Unit 室外機			Outdoor Unit 室外機		
			CU-E18JBH/ CU-2E18CBPGW (Shared Outdoor Unit) (共用室外組件)			CU-E23JBH		
Bedroom 1 睡房1	Split Type Air-Conditioner 分體式冷氣機	Panasonic	Indoor Unit 室內機			Indoor Unit 室內機		
				CS-E12JD4H	CS-E12JD4H	CS-E12JD4H/ CS-E18JD4H	CS-E12JD4H	CS-E12JD4H
			Outdoor Unit 室外機			Outdoor Unit 室外機		
				CU-E12JBH	CU-E12JBH	CU-E12JBH/ CU-E18JBH	CU-E12JBH	CU-E12JBH

The vendor undertakes that if lifts and appliances of the specified brand name or model number are not installed in the Development, lifts or appliances of comparable quality will be installed.  
賣方承諾如該發展項目中沒有安裝指明的品牌名稱或產品型號的升降機或設備，便會安裝品質相若的升降機或設備。

#### Notes:

- The residential floors start from 7/F in all towers of the Development.
- There is no Tower 4 in the Development.
- There are no 4/F, 13/F, 14/F, 24/F and 34/F in all towers of the Development.
- There are no 6/F and 19/F in Tower 1 and Tower 2 and no 20/F and 21/F in Tower 6, Tower 7, Tower 9 and Tower 10.
- There are no 2/F in Tower 3, Tower 5, Tower 6, Tower 7, Tower 8, Tower 9 and Tower 10.
- The symbol “-” as shown in the above table denotes “Not Provided”.
- The cells shaded in grey “■” as shown in the above table denotes “Not Applicable”.

#### 備註：

- 發展項目內所有座樓之住宅由7樓開始。
- 發展項目不設第4座。
- 發展項目內所有座樓均不設4樓、13樓、14樓、24樓及34樓。
- 第1座及第2座均不設6樓及19樓；第6座、第7座、第9座及第10座均不設20樓及21樓。
- 第3座、第5座、第6座、第7座、第8座、第9座及第10座均不設2樓。
- 上表內之“-”符號代表“沒有提供”。
- 上表內填上灰色“■”之部分代表“不適用”。

# FITTINGS, FINISHES AND APPLIANCES

## 裝置、裝修物料及設備

### Appliances Schedule 設備說明表

#### Tower 10 第10座

Location 位置	Appliances 設備	Brand Name 品牌名稱	7/F 7樓				8/F to 19/F & 26/F to 35/F 8樓至19樓及26樓至35樓			
			A	B	C	D	A	B	C	D
			Model Number 產品型號							
Kitchen 廚房	Split Type Air-Conditioner 分體式冷氣機	Panasonic	Indoor Unit 室內機				Indoor Unit 室內機			
			CS-E15HD3EA	CS-E15HD3EA	-	-	CS-E15HD3EA	CS-E15HD3EA	-	-
			Outdoor Unit 室外機				Outdoor Unit 室外機			
			CU-4E23JBE (Shared Outdoor Unit) (共用室外組件)	CU-4E23JBE (Shared Outdoor Unit) (共用室外組件)	-	-	CU-4E23JBE (Shared Outdoor Unit) (共用室外組件)	CU-4E23JBE (Shared Outdoor Unit) (共用室外組件)	-	-

The vendor undertakes that if lifts and appliances of the specified brand name or model number are not installed in the Development, lifts or appliances of comparable quality will be installed.  
賣方承諾如該發展項目中沒有安裝指明的品牌名稱或產品型號的升降機或設備，便會安裝品質相若的升降機或設備。

#### Notes:

- The residential floors start from 7/F in all towers of the Development.
- There is no Tower 4 in the Development.
- There are no 4/F, 13/F, 14/F, 24/F and 34/F in all towers of the Development.
- There are no 6/F and 19/F in Tower 1 and Tower 2 and no 20/F and 21/F in Tower 6, Tower 7, Tower 9 and Tower 10.
- There are no 2/F in Tower 3, Tower 5, Tower 6, Tower 7, Tower 8, Tower 9 and Tower 10.
- The symbol “-” as shown in the above table denotes “Not Provided”.
- The cells shaded in grey “■” as shown in the above table denotes “Not Applicable”.

#### 備註：

- 發展項目內所有座樓之住宅由7樓開始。
- 發展項目不設第4座。
- 發展項目內所有座樓均不設4樓、13樓、14樓、24樓及34樓。
- 第1座及第2座均不設6樓及19樓；第6座、第7座、第9座及第10座均不設20樓及21樓。
- 第3座、第5座、第6座、第7座、第8座、第9座及第10座均不設2樓。
- 上表內之“-”符號代表“沒有提供”。
- 上表內填上灰色“■”之部分代表“不適用”。

# FITTINGS, FINISHES AND APPLIANCES

## 裝置、裝修物料及設備

### Appliances Schedule 設備說明表

#### Tower 10 第10座

Location 位置	Appliances 設備	Brand Name 品牌名稱	22/F to 25/F 22樓至25樓			36/F to 37/F 36樓至37樓		
			B	C	D	A	C	D
			Model Number 產品型號					
Ensuite Bedroom 套房	Split Type Air-Conditioner 分體式冷氣機	Panasonic	Indoor Unit 室內機			Indoor Unit 室內機		
						CS-E18JD4H		
			Outdoor Unit 室外機			Outdoor Unit 室外機		
						CU-E18JBH		
Kitchen 廚房	Split Type Air-Conditioner 分體式冷氣機	Panasonic	Indoor Unit 室內機			Indoor Unit 室內機		
			CS-E15HD3EA	-	-	CS-E15HD3EA	-	-
			Outdoor Unit 室外機			Outdoor Unit 室外機		
			CU-4E23JBE (Shared Outdoor Unit) (共用室外組件)	-	-	CU-4E23JBE (Shared Outdoor Unit) (共用室外組件)	-	-

The vendor undertakes that if lifts and appliances of the specified brand name or model number are not installed in the Development, lifts or appliances of comparable quality will be installed.  
賣方承諾如該發展項目中沒有安裝指明的品牌名稱或產品型號的升降機或設備，便會安裝品質相若的升降機或設備。

#### Notes:

- The residential floors start from 7/F in all towers of the Development.
- There is no Tower 4 in the Development.
- There are no 4/F, 13/F, 14/F, 24/F and 34/F in all towers of the Development.
- There are no 6/F and 19/F in Tower 1 and Tower 2 and no 20/F and 21/F in Tower 6, Tower 7, Tower 9 and Tower 10.
- There are no 2/F in Tower 3, Tower 5, Tower 6, Tower 7, Tower 8, Tower 9 and Tower 10.
- The symbol “-” as shown in the above table denotes “Not Provided”.
- The cells shaded in grey “■” as shown in the above table denotes “Not Applicable”.

#### 備註：

- 發展項目內所有座樓之住宅由7樓開始。
- 發展項目不設第4座。
- 發展項目內所有座樓均不設4樓、13樓、14樓、24樓及34樓。
- 第1座及第2座均不設6樓及19樓；第6座、第7座、第9座及第10座均不設20樓及21樓。
- 第3座、第5座、第6座、第7座、第8座、第9座及第10座均不設2樓。
- 上表內之“-”符號代表“沒有提供”。
- 上表內填上灰色“■”之部分代表“不適用”。

# FITTINGS, FINISHES AND APPLIANCES

## 裝置、裝修物料及設備

### Appliances Schedule 設備說明表

#### Tower 10 第10座

Location 位置	Appliances 設備	Brand Name 品牌名稱	7/F 7樓				8/F to 19/F & 26/F to 35/F 8樓至19樓及26樓至35樓			
			A	B	C	D	A	B	C	D
			Model Number 產品型號							
Store leading from Kitchen 由廚房通往之 士多房	Split Type Air-Conditioner 分體式冷氣機	Panasonic	Indoor Unit 室內機				Indoor Unit 室內機			
			CS-E9JKEW	CS-E9JKEW			CS-E9JKEW	CS-E9JKEW		
			Outdoor Unit 室外機				Outdoor Unit 室外機			
			CU-4E23JBE (Shared Outdoor Unit) (共用室外組件)	CU-4E23JBE (Shared Outdoor Unit) (共用室外組件)			CU-4E23JBE (Shared Outdoor Unit) (共用室外組件)	CU-4E23JBE (Shared Outdoor Unit) (共用室外組件)		
Living Room, Dining Room & Corridor 客廳、飯廳及 走廊	Videophone 視像對講機	Bitron	AV2850/1	AV2850/1	AV2850/1	AV2850/1	AV2850/1	AV2850/1	AV2850/1	AV2850/1
	Door Bell 門鐘	Hager 海格	XC001	XC001	-	-	XC001	XC001	-	-

The vendor undertakes that if lifts and appliances of the specified brand name or model number are not installed in the Development, lifts or appliances of comparable quality will be installed.  
賣方承諾如該發展項目中沒有安裝指明的品牌名稱或產品型號的升降機或設備，便會安裝品質相若的升降機或設備。

#### Notes:

- The residential floors start from 7/F in all towers of the Development.
- There is no Tower 4 in the Development.
- There are no 4/F, 13/F, 14/F, 24/F and 34/F in all towers of the Development.
- There are no 6/F and 19/F in Tower 1 and Tower 2 and no 20/F and 21/F in Tower 6, Tower 7, Tower 9 and Tower 10.
- There are no 2/F in Tower 3, Tower 5, Tower 6, Tower 7, Tower 8, Tower 9 and Tower 10.
- The symbol “-” as shown in the above table denotes “Not Provided”.
- The cells shaded in grey “■” as shown in the above table denotes “Not Applicable”.

#### 備註：

- 發展項目內所有座樓之住宅由7樓開始。
- 發展項目不設第4座。
- 發展項目內所有座樓均不設4樓、13樓、14樓、24樓及34樓。
- 第1座及第2座均不設6樓及19樓；第6座、第7座、第9座及第10座均不設20樓及21樓。
- 第3座、第5座、第6座、第7座、第8座、第9座及第10座均不設2樓。
- 上表內之“-”符號代表“沒有提供”。
- 上表內填上灰色“■”之部分代表“不適用”。

# FITTINGS, FINISHES AND APPLIANCES

## 裝置、裝修物料及設備

### Appliances Schedule 設備說明表

#### Tower 10 第10座

Location 位置	Appliances 設備	Brand Name 品牌名稱	22/F to 25/F 22樓至25樓			36/F to 37/F 36樓至37樓		
			B	C	D	A	C	D
			Model Number 產品型號					
Store leading from Kitchen 由廚房通往之 士多房	Split Type Air-Conditioner 分體式冷氣機	Panasonic	Indoor Unit 室內機			Indoor Unit 室內機		
			CS-E9JKEW			CS-E9JKEW		
			Outdoor Unit 室外機			Outdoor Unit 室外機		
			CU-4E23JBE (Shared Outdoor Unit) (共用室外組件)			CU-4E23JBE (Shared Outdoor Unit) (共用室外組件)		
Living Room, Dining Room & Corridor 客廳、飯廳及 走廊	Videophone 視像對講機	Bitron	AV2850/1	AV2850/1	AV2850/1	-	-	-
	Door Bell 門鐘	Hager 海格	XC001	-	-	XC001	-	-

The vendor undertakes that if lifts and appliances of the specified brand name or model number are not installed in the Development, lifts or appliances of comparable quality will be installed.  
賣方承諾如該發展項目中沒有安裝指明的品牌名稱或產品型號的升降機或設備，便會安裝品質相若的升降機或設備。

#### Notes:

- The residential floors start from 7/F in all towers of the Development.
- There is no Tower 4 in the Development.
- There are no 4/F, 13/F, 14/F, 24/F and 34/F in all towers of the Development.
- There are no 6/F and 19/F in Tower 1 and Tower 2 and no 20/F and 21/F in Tower 6, Tower 7, Tower 9 and Tower 10.
- There are no 2/F in Tower 3, Tower 5, Tower 6, Tower 7, Tower 8, Tower 9 and Tower 10.
- The symbol “-” as shown in the above table denotes “Not Provided”.
- The cells shaded in grey “■” as shown in the above table denotes “Not Applicable”.

#### 備註：

- 發展項目內所有座樓之住宅由7樓開始。
- 發展項目不設第4座。
- 發展項目內所有座樓均不設4樓、13樓、14樓、24樓及34樓。
- 第1座及第2座均不設6樓及19樓；第6座、第7座、第9座及第10座均不設20樓及21樓。
- 第3座、第5座、第6座、第7座、第8座、第9座及第10座均不設2樓。
- 上表內之“-”符號代表“沒有提供”。
- 上表內填上灰色“■”之部分代表“不適用”。

# FITTINGS, FINISHES AND APPLIANCES

## 裝置、裝修物料及設備

### Appliances Schedule 設備說明表

#### Tower 10 第10座

Location 位置	Appliances 設備	Brand Name 品牌名稱	7/F 7樓				8/F to 19/F & 26/F to 35/F 8樓至19樓及26樓至35樓			
			A	B	C	D	A	B	C	D
			Model Number 產品型號							
Kitchen 廚房	Cooker Hood 抽油煙機	Miele 美諾	DA3190	DA3190	DA3190	DA3190	DA3190	DA3190	DA3190	DA3190
	Gas Cooking Hob 煤氣煮食爐	Miele 美諾	CS1018G CS1013G	CS1018G CS1013G	CS1018G CS1013G	CS1018G CS1013G	CS1018G CS1013G	CS1018G CS1013G	CS1018G CS1013G	CS1018G CS1013G
	Gas Water Heater 煤氣熱水爐	TGC	NJW160TFQL <sup>(1)</sup>	NJW160TFQL <sup>(1)</sup>	NJW160TFQL <sup>(2)</sup>	NJW160TFQL <sup>(2)</sup>	NJW160TFQL <sup>(1)</sup>	NJW160TFQL <sup>(1)</sup>	NJW160TFQL <sup>(2)</sup>	NJW160TFQL <sup>(2)</sup>
	Microwave Oven 微波爐	Miele 美諾	M8161-2	M8161-2	M8161-2	M8161-2	M8161-2	M8161-2	M8161-2	M8161-2
	Refrigerator 雪櫃	Siemens 西門子	KI38VA/ KU15R	KI38VA/ KU15R	KI38VA	KI38VA	KI38VA/ KU15R	KI38VA/ KU15R	KI38VA	KI38VA
	Washer/Dryer 洗衣/乾衣機	Siemens 西門子	WK16D	WK16D	WK16D	WK16D	WK16D	WK16D	WK16D	WK16D
	Exhaust Fan 抽氣扇	Xpelair	GX 6	GX 6	GX 6	GX 6	GX 6	GX 6	GX 6	GX 6

The vendor undertakes that if lifts and appliances of the specified brand name or model number are not installed in the Development, lifts or appliances of comparable quality will be installed.  
賣方承諾如該發展項目中沒有安裝指明的品牌名稱或產品型號的升降機或設備，便會安裝品質相若的升降機或設備。

#### Notes:

- The residential floors start from 7/F in all towers of the Development.
  - There is no Tower 4 in the Development.
  - There are no 4/F, 13/F, 14/F, 24/F and 34/F in all towers of the Development.
  - There are no 6/F and 19/F in Tower 1 and Tower 2 and no 20/F and 21/F in Tower 6, Tower 7, Tower 9 and Tower 10.
  - There are no 2/F in Tower 3, Tower 5, Tower 6, Tower 7, Tower 8, Tower 9 and Tower 10.
  - The symbol “-” as shown in the above table denotes “Not Provided”.
  - The cells shaded in grey “■” as shown in the above table denotes “Not Applicable”.
- (1) : The gas water heater located at A/C room & served for Lavatory leading from Kitchen, Kitchen and Bathroom  
(2) : The gas water heater located at A/C room & served for Kitchen and Bathroom  
(3) : The gas water heater located at A/C room & served for Lavatory leading from Kitchen and Bathroom next to Ensuite Bedroom

#### 備註：

- 發展項目內所有座樓之住宅由7樓開始。
  - 發展項目不設第4座。
  - 發展項目內所有座樓均不設4樓、13樓、14樓、24樓及34樓。
  - 第1座及第2座均不設6樓及19樓；第6座、第7座、第9座及第10座均不設20樓及21樓。
  - 第3座、第5座、第6座、第7座、第8座、第9座及第10座均不設2樓。
  - 上表內之“-”符號代表“沒有提供”。
  - 上表內填上灰色“■”之部分代表“不適用”。
- (1) : 該款煤氣熱水爐位於冷氣機房及供應熱水給由廚房通往之洗手間、廚房和浴室  
(2) : 該款煤氣熱水爐位於冷氣機房及供應熱水給廚房和浴室  
(3) : 該款煤氣熱水爐位於冷氣機房及供應熱水給由廚房通往之洗手間和套房旁之浴室

# FITTINGS, FINISHES AND APPLIANCES

## 裝置、裝修物料及設備

### Appliances Schedule 設備說明表

#### Tower 10 第10座

Location 位置	Appliances 設備	Brand Name 品牌名稱	22/F to 25/F 22樓至25樓			36/F to 37/F 36樓至37樓		
			B	C	D	A	C	D
			Model Number 產品型號					
Kitchen 廚房	Cooker Hood 抽油煙機	Miele 美諾	DA3190	DA3190	DA3190	DA422-4	DA3190	DA3190
	Gas Cooking Hob 煤氣煮食爐	Miele 美諾	CS1018G CS1013G	CS1018G CS1013G	CS1018G CS1013G	CS1018G CS1013G	CS1018G CS1013G	CS1018G CS1013G
	Gas Water Heater 煤氣熱水爐	TGC	NJW160TFQL <sup>(1)</sup>	NJW160TFQL <sup>(2)</sup>	NJW160TFQL <sup>(2)</sup>	NJW220TFQL <sup>(2)</sup>	NJW160TFQL <sup>(2)</sup>	NJW160TFQL <sup>(2)</sup>
	Microwave Oven 微波爐	Miele 美諾	M8161-2	M8161-2	M8161-2	M8161-2	M8161-2	M8161-2
	Refrigerator 雪櫃	Siemens 西門子	KI38VA/ KU15R	KI38VA	KI38VA	-	KI38VA	KI38VA
		Sub-Zero	-	-	-	ICBBI-42S	-	-
	Washer/Dryer 洗衣/乾衣機	Miele 美諾	-	-	-	WT2789i	-	-
Siemens 西門子		WK16D	WK16D	WK16D	-	WK16D	WK16D	

The vendor undertakes that if lifts and appliances of the specified brand name or model number are not installed in the Development, lifts or appliances of comparable quality will be installed.  
賣方承諾如該發展項目中沒有安裝指明的品牌名稱或產品型號的升降機或設備，便會安裝品質相若的升降機或設備。

#### Notes:

- The residential floors start from 7/F in all towers of the Development.
  - There is no Tower 4 in the Development.
  - There are no 4/F, 13/F, 14/F, 24/F and 34/F in all towers of the Development.
  - There are no 6/F and 19/F in Tower 1 and Tower 2 and no 20/F and 21/F in Tower 6, Tower 7, Tower 9 and Tower 10.
  - There are no 2/F in Tower 3, Tower 5, Tower 6, Tower 7, Tower 8, Tower 9 and Tower 10.
  - The symbol “-” as shown in the above table denotes “Not Provided”.
  - The cells shaded in grey “■” as shown in the above table denotes “Not Applicable”.
- (1) : The gas water heater located at A/C room & served for Lavatory leading from Kitchen, Kitchen and Bathroom  
(2) : The gas water heater located at A/C room & served for Kitchen and Bathroom  
(3) : The gas water heater located at A/C room & served for Lavatory leading from Kitchen and Bathroom next to Ensuite Bedroom

#### 備註:

- 發展項目內所有座樓之住宅由7樓開始。
  - 發展項目不設第4座。
  - 發展項目內所有座樓均不設4樓、13樓、14樓、24樓及34樓。
  - 第1座及第2座均不設6樓及19樓；第6座、第7座、第9座及第10座均不設20樓及21樓。
  - 第3座、第5座、第6座、第7座、第8座、第9座及第10座均不設2樓。
  - 上表內之“-”符號代表“沒有提供”。
  - 上表內填上灰色“■”之部分代表“不適用”。
- (1) : 該款煤氣熱水爐位於冷氣機房及供應熱水給由廚房通往之洗手間、廚房和浴室  
(2) : 該款煤氣熱水爐位於冷氣機房及供應熱水給廚房和浴室  
(3) : 該款煤氣熱水爐位於冷氣機房及供應熱水給由廚房通往之洗手間和套房旁之浴室



# FITTINGS, FINISHES AND APPLIANCES

## 裝置、裝修物料及設備

### Appliances Schedule 設備說明表

#### Tower 10 第10座

Location 位置	Appliances 設備	Brand Name 品牌名稱	7/F 7樓				8/F to 19/F & 26/F to 35/F 8樓至19樓及26樓至35樓			
			A	B	C	D	A	B	C	D
			Model Number 產品型號							
Kitchen 廚房	Induction Hob 電磁爐	Miele 美諾	CS1212	CS1212	-	-	CS1212	CS1212	-	-
	Steam Oven 電蒸爐	Miele 美諾	DGC5051	DGC5051	-	-	DGC5051	DGC5051	-	-
	Wine Cellar 酒櫃	Miele 美諾	KWT4154UG-1	KWT4154UG-1	-	-	KWT4154UG-1	KWT4154UG-1	-	-
	Door Bell 門鐘	Hager 海格	XC001	XC001	XC001	XC001	XC001	XC001	XC001	XC001

The vendor undertakes that if lifts and appliances of the specified brand name or model number are not installed in the Development, lifts or appliances of comparable quality will be installed.  
賣方承諾如該發展項目中沒有安裝指明的品牌名稱或產品型號的升降機或設備，便會安裝品質相若的升降機或設備。

#### Notes:

- The residential floors start from 7/F in all towers of the Development.
- There is no Tower 4 in the Development.
- There are no 4/F, 13/F, 14/F, 24/F and 34/F in all towers of the Development.
- There are no 6/F and 19/F in Tower 1 and Tower 2 and no 20/F and 21/F in Tower 6, Tower 7, Tower 9 and Tower 10.
- There are no 2/F in Tower 3, Tower 5, Tower 6, Tower 7, Tower 8, Tower 9 and Tower 10.
- The symbol “-” as shown in the above table denotes “Not Provided”.
- The cells shaded in grey “■” as shown in the above table denotes “Not Applicable”.

#### 備註：

- 發展項目內所有座樓之住宅由7樓開始。
- 發展項目不設第4座。
- 發展項目內所有座樓均不設4樓、13樓、14樓、24樓及34樓。
- 第1座及第2座均不設6樓及19樓；第6座、第7座、第9座及第10座均不設20樓及21樓。
- 第3座、第5座、第6座、第7座、第8座、第9座及第10座均不設2樓。
- 上表內之“-”符號代表“沒有提供”。
- 上表內填上灰色“■”之部分代表“不適用”。

# FITTINGS, FINISHES AND APPLIANCES

## 裝置、裝修物料及設備

### Appliances Schedule 設備說明表

#### Tower 10 第10座

Location 位置	Appliances 設備	Brand Name 品牌名稱	22/F to 25/F 22樓至25樓			36/F to 37/F 36樓至37樓		
			B	C	D	A	C	D
			Model Number 產品型號					
Kitchen 廚房	Exhaust Fan 抽氣扇	Xpelair	GX 6	GX 6	GX 6	GX 6	GX 6	GX 6
	Induction Hob 電磁爐	Miele 美諾	CS1212	-	-	CS1212	-	-
	Steam Oven 電蒸爐	Miele 美諾	DGC5051	-	-	DGC5051	-	-
	Wine Cellar 酒櫃	Miele 美諾	KWT4154UG-1	-	-	KWT4154UG-1	-	-
	Door Bell 門鐘	Hager 海格	XC001	XC001	XC001	XC001	XC001	XC001
	Videophone 視像對講機	Bitron	-	-	-	AV2850/1	AV2850/1	AV2850/1

The vendor undertakes that if lifts and appliances of the specified brand name or model number are not installed in the Development, lifts or appliances of comparable quality will be installed.  
賣方承諾如該發展項目中沒有安裝指明的品牌名稱或產品型號的升降機或設備，便會安裝品質相若的升降機或設備。

#### Notes:

- The residential floors start from 7/F in all towers of the Development.
- There is no Tower 4 in the Development.
- There are no 4/F, 13/F, 14/F, 24/F and 34/F in all towers of the Development.
- There are no 6/F and 19/F in Tower 1 and Tower 2 and no 20/F and 21/F in Tower 6, Tower 7, Tower 9 and Tower 10.
- There are no 2/F in Tower 3, Tower 5, Tower 6, Tower 7, Tower 8, Tower 9 and Tower 10.
- The symbol “-” as shown in the above table denotes “Not Provided”.
- The cells shaded in grey “■” as shown in the above table denotes “Not Applicable”.

#### 備註：

- 發展項目內所有座樓之住宅由7樓開始。
- 發展項目不設第4座。
- 發展項目內所有座樓均不設4樓、13樓、14樓、24樓及34樓。
- 第1座及第2座均不設6樓及19樓；第6座、第7座、第9座及第10座均不設20樓及21樓。
- 第3座、第5座、第6座、第7座、第8座、第9座及第10座均不設2樓。
- 上表內之“-”符號代表“沒有提供”。
- 上表內填上灰色“■”之部分代表“不適用”。

# FITTINGS, FINISHES AND APPLIANCES

## 裝置、裝修物料及設備

### Appliances Schedule 設備說明表

#### Tower 10 第10座

Location 位置	Appliances 設備	Brand Name 品牌名稱	7/F 7樓				8/F to 19/F & 26/F to 35/F 8樓至19樓及26樓至35樓			
			A	B	C	D	A	B	C	D
			Model Number 產品型號							
Bathroom in Master Bedroom 主人房內之浴室	10" LCD TV 10"液晶體電視	JSA	TMBG10i	TMBG10i			TMBG10i	TMBG10i		
	Gas Water Heater 煤氣熱水爐	TGC	NJW220TFQL	NJW220TFQL			NJW220TFQL	NJW220TFQL		
	Exhaust Fan 抽氣扇	Ostberg 奧斯博格	RFE 140A	RFE 140A			RFE 140A	RFE 140A		
Bathroom 浴室	Gas Water Heater 煤氣熱水爐	TGC	NJW160TFQL <sup>(1)</sup>	NJW160TFQL <sup>(1)</sup>	NJW160TFQL <sup>(2)</sup>	NJW160TFQL <sup>(2)</sup>	NJW160TFQL <sup>(1)</sup>	NJW160TFQL <sup>(1)</sup>	NJW160TFQL <sup>(2)</sup>	NJW160TFQL <sup>(2)</sup>
	Exhaust Fan 抽氣扇	Xpelair	-	-	-	GX 6	-	-	-	GX 6
		Ostberg 奧斯博格	RFE 140B	RFE 140B	RFE 140A	-	RFE 140B	RFE 140B	RFE 140A	-

The vendor undertakes that if lifts and appliances of the specified brand name or model number are not installed in the Development, lifts or appliances of comparable quality will be installed.  
賣方承諾如該發展項目中沒有安裝指明的品牌名稱或產品型號的升降機或設備，便會安裝品質相若的升降機或設備。

#### Notes:

- The residential floors start from 7/F in all towers of the Development.
  - There is no Tower 4 in the Development.
  - There are no 4/F, 13/F, 14/F, 24/F and 34/F in all towers of the Development.
  - There are no 6/F and 19/F in Tower 1 and Tower 2 and no 20/F and 21/F in Tower 6, Tower 7, Tower 9 and Tower 10.
  - There are no 2/F in Tower 3, Tower 5, Tower 6, Tower 7, Tower 8, Tower 9 and Tower 10.
  - The symbol “-” as shown in the above table denotes “Not Provided”.
  - The cells shaded in grey “■” as shown in the above table denotes “Not Applicable”.
- (1) : The gas water heater located at A/C room & served for Lavatory leading from Kitchen, Kitchen and Bathroom  
(2) : The gas water heater located at A/C room & served for Kitchen and Bathroom  
(3) : The gas water heater located at A/C room & served for Lavatory leading from Kitchen and Bathroom next to Ensuite Bedroom

#### 備註:

- 發展項目內所有座樓之住宅由7樓開始。
  - 發展項目不設第4座。
  - 發展項目內所有座樓均不設4樓、13樓、14樓、24樓及34樓。
  - 第1座及第2座均不設6樓及19樓；第6座、第7座、第9座及第10座均不設20樓及21樓。
  - 第3座、第5座、第6座、第7座、第8座、第9座及第10座均不設2樓。
  - 上表內之“-”符號代表“沒有提供”。
  - 上表內填上灰色“■”之部分代表“不適用”。
- (1) : 該款煤氣熱水爐位於冷氣機房及供應熱水給由廚房通往之洗手間、廚房和浴室  
(2) : 該款煤氣熱水爐位於冷氣機房及供應熱水給廚房和浴室  
(3) : 該款煤氣熱水爐位於冷氣機房及供應熱水給由廚房通往之洗手間和套房旁之浴室

# FITTINGS, FINISHES AND APPLIANCES

## 裝置、裝修物料及設備

### Appliances Schedule 設備說明表

#### Tower 10 第10座

Location 位置	Appliances 設備	Brand Name 品牌名稱	22/F to 25/F 22樓至25樓			36/F to 37/F 36樓至37樓		
			B	C	D	A	C	D
			Model Number 產品型號					
Bathroom in Master Bedroom 主人房內之浴室	15"LCD TV 15"液晶電視	JSA	-			TMBG15		
	10"LCD TV 10"液晶電視	JSA	TMBG10i			-		
	Ceiling Speaker 揚聲器	OBT	-			-		
		KEF	-			2 x Cs130.2FS		
	Gas Water Heater 煤氣熱水爐	TGC	NJW220TFQL			NJW220TFQL		
	Exhaust Fan 抽氣扇	Ostberg 奧斯博格	RFE 140A			RFE 200B		
Bathroom 浴室	Gas Water Heater 煤氣熱水爐	TGC	NJW160TFQL <sup>(1)</sup>	NJW160TFQL <sup>(2)</sup>	NJW160TFQL <sup>(2)</sup>	NJW220TFQL <sup>(2)</sup>	NJW160TFQL <sup>(2)</sup>	NJW160TFQL
	Exhaust Fan 抽氣扇	Xpelair	-	-	GX 6	-	-	GX 6
		Ostberg 奧斯博格	RFE 140B	RFE 140A	-	RFE 140A	RFE 140A	-

The vendor undertakes that if lifts and appliances of the specified brand name or model number are not installed in the Development, lifts or appliances of comparable quality will be installed.  
賣方承諾如該發展項目中沒有安裝指明的品牌名稱或產品型號的升降機或設備，便會安裝品質相若的升降機或設備。

#### Notes:

- The residential floors start from 7/F in all towers of the Development.
  - There is no Tower 4 in the Development.
  - There are no 4/F, 13/F, 14/F, 24/F and 34/F in all towers of the Development.
  - There are no 6/F and 19/F in Tower 1 and Tower 2 and no 20/F and 21/F in Tower 6, Tower 7, Tower 9 and Tower 10.
  - There are no 2/F in Tower 3, Tower 5, Tower 6, Tower 7, Tower 8, Tower 9 and Tower 10.
  - The symbol "-" as shown in the above table denotes "Not Provided".
  - The cells shaded in grey "■" as shown in the above table denotes "Not Applicable".
- (1): The gas water heater located at A/C room & served for Lavatory leading from Kitchen, Kitchen and Bathroom  
(2): The gas water heater located at A/C room & served for Kitchen and Bathroom  
(3): The gas water heater located at A/C room & served for Lavatory leading from Kitchen and Bathroom next to Ensuite Bedroom

#### 備註:

- 發展項目內所有座樓之住宅由7樓開始。
  - 發展項目不設第4座。
  - 發展項目內所有座樓均不設4樓、13樓、14樓、24樓及34樓。
  - 第1座及第2座均不設6樓及19樓；第6座、第7座、第9座及第10座均不設20樓及21樓。
  - 第3座、第5座、第6座、第7座、第8座、第9座及第10座均不設2樓。
  - 上表內之“-”符號代表“沒有提供”。
  - 上表內填上灰色“■”之部分代表“不適用”。
- (1): 該款煤氣熱水爐位於冷氣機房及供應熱水給由廚房通往之洗手間、廚房和浴室  
(2): 該款煤氣熱水爐位於冷氣機房及供應熱水給廚房和浴室  
(3): 該款煤氣熱水爐位於冷氣機房及供應熱水給由廚房通往之洗手間和套房旁之浴室

# FITTINGS, FINISHES AND APPLIANCES

## 裝置、裝修物料及設備

### Appliances Schedule 設備說明表

#### Tower 10 第10座

Location 位置	Appliances 設備	Brand Name 品牌名稱	7/F 7樓				8/F to 19/F & 26/F to 35/F 8樓至19樓及26樓至35樓			
			A	B	C	D	A	B	C	D
			Model Number 產品型號							
Lavatory leading from Kitchen 由廚房通往之 洗手間	Gas Water Heater 煤氣熱水爐	TGC	NJW160TFQL <sup>(1)</sup>	NJW160TFQL <sup>(1)</sup>			NJW160TFQL <sup>(1)</sup>	NJW160TFQL <sup>(1)</sup>		
	Exhaust Fan 抽氣扇	Xpelair	GX 6	GX 6			GX 6	GX 6		

The vendor undertakes that if lifts and appliances of the specified brand name or model number are not installed in the Development, lifts or appliances of comparable quality will be installed.  
賣方承諾如該發展項目中沒有安裝指明的品牌名稱或產品型號的升降機或設備，便會安裝品質相若的升降機或設備。

#### Notes:

- The residential floors start from 7/F in all towers of the Development.
  - There is no Tower 4 in the Development.
  - There are no 4/F, 13/F, 14/F, 24/F and 34/F in all towers of the Development.
  - There are no 6/F and 19/F in Tower 1 and Tower 2 and no 20/F and 21/F in Tower 6, Tower 7, Tower 9 and Tower 10.
  - There are no 2/F in Tower 3, Tower 5, Tower 6, Tower 7, Tower 8, Tower 9 and Tower 10.
  - The symbol “-” as shown in the above table denotes “Not Provided”.
  - The cells shaded in grey “■” as shown in the above table denotes “Not Applicable”.
- (1) : The gas water heater located at A/C room & served for Lavatory leading from Kitchen, Kitchen and Bathroom  
(2) : The gas water heater located at A/C room & served for Kitchen and Bathroom  
(3) : The gas water heater located at A/C room & served for Lavatory leading from Kitchen and Bathroom next to Ensuite Bedroom

#### 備註：

- 發展項目內所有座樓之住宅由7樓開始。
  - 發展項目不設第4座。
  - 發展項目內所有座樓均不設4樓、13樓、14樓、24樓及34樓。
  - 第1座及第2座均不設6樓及19樓；第6座、第7座、第9座及第10座均不設20樓及21樓。
  - 第3座、第5座、第6座、第7座、第8座、第9座及第10座均不設2樓。
  - 上表內之“-”符號代表“沒有提供”。
  - 上表內填上灰色“■”之部分代表“不適用”。
- (1) : 該款煤氣熱水爐位於冷氣機房及供應熱水給由廚房通往之洗手間、廚房和浴室  
(2) : 該款煤氣熱水爐位於冷氣機房及供應熱水給廚房和浴室  
(3) : 該款煤氣熱水爐位於冷氣機房及供應熱水給由廚房通往之洗手間和套房旁之浴室

# FITTINGS, FINISHES AND APPLIANCES

## 裝置、裝修物料及設備

### Appliances Schedule 設備說明表

#### Tower 10 第10座

Location 位置	Appliances 設備	Brand Name 品牌名稱	22/F to 25/F 22樓至25樓			36/F to 37/F 36樓至37樓		
			B	C	D	A	C	D
			Model Number 產品型號					
Bathroom next to Ensuite Bedroom 套房旁之浴室	Gas Water Heater 煤氣熱水爐	TGC				NJW220TFQL <sup>(3)</sup>		
	Exhaust Fan 抽氣扇	Ostberg 奧斯博格				RFE 140A		
Lavatory leading from Kitchen 由廚房通往之 洗手間	Gas Water Heater 煤氣熱水爐	TGC	NJW160TFQL <sup>(1)</sup>			NJW220TFQL <sup>(3)</sup>		
	Exhaust Fan 抽氣扇	Xpelair	GX 6			GX 6		

The vendor undertakes that if lifts and appliances of the specified brand name or model number are not installed in the Development, lifts or appliances of comparable quality will be installed.  
賣方承諾如該發展項目中沒有安裝指明的品牌名稱或產品型號的升降機或設備，便會安裝品質相若的升降機或設備。

#### Notes:

- The residential floors start from 7/F in all towers of the Development.
  - There is no Tower 4 in the Development.
  - There are no 4/F, 13/F, 14/F, 24/F and 34/F in all towers of the Development.
  - There are no 6/F and 19/F in Tower 1 and Tower 2 and no 20/F and 21/F in Tower 6, Tower 7, Tower 9 and Tower 10.
  - There are no 2/F in Tower 3, Tower 5, Tower 6, Tower 7, Tower 8, Tower 9 and Tower 10.
  - The symbol “-” as shown in the above table denotes “Not Provided”.
  - The cells shaded in grey “■” as shown in the above table denotes “Not Applicable”.
- (1): The gas water heater located at A/C room & served for Lavatory leading from Kitchen, Kitchen and Bathroom  
(2): The gas water heater located at A/C room & served for Kitchen and Bathroom  
(3): The gas water heater located at A/C room & served for Lavatory leading from Kitchen and Bathroom next to Ensuite Bedroom

#### 備註:

- 發展項目內所有座樓之住宅由7樓開始。
  - 發展項目不設第4座。
  - 發展項目內所有座樓均不設4樓、13樓、14樓、24樓及34樓。
  - 第1座及第2座均不設6樓及19樓；第6座、第7座、第9座及第10座均不設20樓及21樓。
  - 第3座、第5座、第6座、第7座、第8座、第9座及第10座均不設2樓。
  - 上表內之“-”符號代表“沒有提供”。
  - 上表內填上灰色“■”之部分代表“不適用”。
- (1): 該款煤氣熱水爐位於冷氣機房及供應熱水給由廚房通往之洗手間、廚房和浴室  
(2): 該款煤氣熱水爐位於冷氣機房及供應熱水給廚房和浴室  
(3): 該款煤氣熱水爐位於冷氣機房及供應熱水給由廚房通往之洗手間和套房旁之浴室

# FITTINGS, FINISHES AND APPLIANCES

## 裝置、裝修物料及設備

### Schedule of Mechanical and Electrical Provisions 機電裝置數量說明表

#### Tower 10 第10座

Location 位置	Exposed Type 外露型	Non-Exposed Type 非外露型	7/F 7樓				8/F to 19/F & 26/F to 35/F 8樓至19樓及 26樓至35樓				22/F to 25/F 22樓至25樓			36/F 36樓			37/F 37樓			
			A	B	C	D	A	B	C	D	B	C	D	A	C	D	A	C	D	
Living Room, Dining Room & Corridor 客廳、飯廳及 走廊	TV/ FM Outlet 電視/電台天線插座		3	3	1	1	3	3	2	2	3	2	2	2	2	2	2	2	2	
	Telephone Outlet 電話插座		2	2	2	2	2	2	2	2	2	2	2	2	2	2	2	2	2	
	13A Twin Socket Outlet 13A雙位電插座		5	5	2	2	6	6	4	4	6	4	4	5	4	4	5	4	4	
	13A Single Socket Outlet 13A單位電插座		5	5	5	5	3	3	5	5	3	5	5	5	5	5	4	5	5	
	Lighting Switch 燈掣		7	7	5	5	6	6	5	5	6	5	5	11	5	5	9	5	5	
		Door Bell 門鐘		1	1	-	-	1	1	-	-	1	-	-	1	-	-	1	-	-
		Door Phone Handset 對講機		1	1	1	1	1	1	1	1	1	1	1	-	1	1	-	1	1
		20A Double Pole Switch with Pilot Lamp 20A 雙極開關掣		2	2	2	2	2	2	2	2	2	2	2	3	2	2	3	2	2
	Fused Spur Unit/Connection Unit 接線座		1	1	-	-	1	1	-	-	1	-	-	1	-	-	1	-	-	
Master Bedroom 主人房	TV/ FM Outlet 電視/電台天線插座		2	2			2	2			2			2			2			
	Telephone Outlet 電話插座		2	2			2	2			2			2			2			
	13A Twin Socket Outlet 13A雙位電插座		3	3			3	3			3			4			4			
	13A Single Socket Outlet 13A單位電插座		1	1			1	1			1			2			2			
	Lighting Switch 燈掣		4	4			4	4			4			3			3			
	20A Double Pole Switch with Pilot Lamp 20A 雙極開關掣		1	1			1	1			1			2			2			

#### Notes:

- The residential floors start from 7/F in all towers of the Development.
- There is no Tower 4 in the Development.
- There are no 4/F, 13/F, 14/F, 24/F and 34/F in all towers of the Development.
- There are no 6/F and 19/F in Tower 1 and Tower 2 and no 20/F and 21/F in Tower 6, Tower 7, Tower 9 and Tower 10.
- There are no 2/F in Tower 3, Tower 5, Tower 6, Tower 7, Tower 8, Tower 9 and Tower 10.
- The symbol “-” as shown in the above table denotes “Not Provided”.
- The cells shaded in grey “■” as shown in the above table denotes “Not Applicable”.

#### 備註:

- 發展項目內所有座樓之住宅由7樓開始。
- 發展項目不設第4座。
- 發展項目內所有座樓均不設4樓、13樓、14樓、24樓及34樓。
- 第1座及第2座均不設6樓及19樓；第6座、第7座、第9座及第10座均不設20樓及21樓。
- 第3座、第5座、第6座、第7座、第8座、第9座及第10座均不設2樓。
- 上表內之“-”符號代表“沒有提供”。
- 上表內填上灰色“■”之部分代表“不適用”。

# FITTINGS, FINISHES AND APPLIANCES

## 裝置、裝修物料及設備

### Schedule of Mechanical and Electrical Provisions 機電裝置數量說明表

#### Tower 10 第10座

Location 位置	Exposed Type 外露型	Non-Exposed Type 非外露型	7/F 7樓				8/F to 19/F & 26/F to 35/F 8樓至19樓及 26樓至35樓				22/F to 25/F 22樓至25樓			36/F 36樓			37/F 37樓		
			A	B	C	D	A	B	C	D	B	C	D	A	C	D	A	C	D
Bedroom 1 睡房1	TV/ FM Outlet 電視/電台天線插座				1	1			1	1		1	1	2	1	1	2	1	1
	Telephone Outlet 電話插座				1	1			1	1		1	1	2	1	1	2	1	1
	13A Twin Socket Outlet 13A雙位電插座				2	2			2	2		2	2	2	2	2	2	2	2
	13A Single Socket Outlet 13A單位電插座				1	1			1	1		1	1	1	1	1	1	1	1
	Lighting Switch 燈掣				1	1			1	1		1	1	2	1	1	2	1	1
Ensuite Bedroom 套房	TV/ FM Outlet 電視/電台天線插座													2			2		
	Telephone Outlet 電話插座													1			1		
	13A Twin Socket Outlet 13A雙位電插座													4			4		
	13A Single Socket Outlet 13A單位電插座													2			2		
	Lighting Switch 燈掣													3			2		

#### Notes:

- The residential floors start from 7/F in all towers of the Development.
- There is no Tower 4 in the Development.
- There are no 4/F, 13/F, 14/F, 24/F and 34/F in all towers of the Development.
- There are no 6/F and 19/F in Tower 1 and Tower 2 and no 20/F and 21/F in Tower 6, Tower 7, Tower 9 and Tower 10.
- There are no 2/F in Tower 3, Tower 5, Tower 6, Tower 7, Tower 8, Tower 9 and Tower 10.
- The symbol “-” as shown in the above table denotes “Not Provided”.
- The cells shaded in grey “■” as shown in the above table denotes “Not Applicable”.

#### 備註:

- 發展項目內所有座樓之住宅由7樓開始。
- 發展項目不設第4座。
- 發展項目內所有座樓均不設4樓、13樓、14樓、24樓及34樓。
- 第1座及第2座均不設6樓及19樓；第6座、第7座、第9座及第10座均不設20樓及21樓。
- 第3座、第5座、第6座、第7座、第8座、第9座及第10座均不設2樓。
- 上表內之“-”符號代表“沒有提供”。
- 上表內填上灰色“■”之部分代表“不適用”。



# FITTINGS, FINISHES AND APPLIANCES

## 裝置、裝修物料及設備

### Schedule of Mechanical and Electrical Provisions

#### 機電裝置數量說明表

#### Tower 10 第10座

Location 位置	Exposed Type 外露型	Non-Exposed Type 非外露型	7/F 7樓				8/F to 19/F & 26/F to 35/F 8樓至19樓及 26樓至35樓				22/F to 25/F 22樓至25樓			36/F 36樓			37/F 37樓		
			A	B	C	D	A	B	C	D	B	C	D	A	C	D	A	C	D
Store leading from Kitchen 由廚房通往之 士多房	TV/ FM Outlet 電視/電台天線插座		1	1			1	1			1			1			1		
	Telephone Outlet 電話插座		-	-			-	-			-			1			1		
	13A Twin Socket Outlet 13A雙位電插座		2	2			1	1			1			1			1		
	Lighting Switch 燈掣		1	1			1	1			1			2			2		
20A Double Pole Switch with Pilot Lamp 20A 雙極開關掣		2	2			1	1			1			2			2			
Store near to Living Room 鄰近客廳之 士多房	13A Single Socket Outlet 13A單位電插座												1			1			
	Lighting Switch 燈掣												1			-			
Bathroom in Master Bedroom 主人房內之浴室	TV/ FM Outlet 電視/電台天線插座		1	1			1	1			1			1			1		
	13A Single Socket Outlet 13A單位電插座		3	3			3	3			3			2			2		
	Fused Spur Unit/Connection Unit 接線座		1	1			1	1			1			1			1		
Bathroom 浴室	TV/ FM Outlet 電視/電台天線插座		-	-	1	1	-	-	1	1	-	1	1	-	-	-	-	-	-
	13A Single Socket Outlet 13A單位電插座		1	1	2	2	1	1	2	2	1	2	2	1	2	2	1	2	2
	Fused Spur Unit/Connection Unit 接線座		1	1	1	1	1	1	1	1	1	1	1	1	1	1	1	1	1
Bathroom next to Ensuite Bedroom 套房旁之浴室	13A Single Socket Outlet 13A單位電插座													1			1		
	Fused Spur Unit/Connection Unit 接線座													1			1		

#### Notes:

- The residential floors start from 7/F in all towers of the Development.
- There is no Tower 4 in the Development.
- There are no 4/F, 13/F, 14/F, 24/F and 34/F in all towers of the Development.
- There are no 6/F and 19/F in Tower 1 and Tower 2 and no 20/F and 21/F in Tower 6, Tower 7, Tower 9 and Tower 10.
- There are no 2/F in Tower 3, Tower 5, Tower 6, Tower 7, Tower 8, Tower 9 and Tower 10.
- The symbol “-” as shown in the above table denotes “Not Provided”.
- The cells shaded in grey “■” as shown in the above table denotes “Not Applicable”.

#### 備註:

- 發展項目內所有座樓之住宅由7樓開始。
- 發展項目不設第4座。
- 發展項目內所有座樓均不設4樓、13樓、14樓、24樓及34樓。
- 第1座及第2座均不設6樓及19樓；第6座、第7座、第9座及第10座均不設20樓及21樓。
- 第3座、第5座、第6座、第7座、第8座、第9座及第10座均不設2樓。
- 上表內之“-”符號代表“沒有提供”。
- 上表內填上灰色“■”之部分代表“不適用”。

# FITTINGS, FINISHES AND APPLIANCES

## 裝置、裝修物料及設備

### Schedule of Mechanical and Electrical Provisions 機電裝置數量說明表

#### Tower 10 第10座

Location 位置	Exposed Type 外露型	Non-Exposed Type 非外露型	7/F 7樓				8/F to 19/F & 26/F to 35/F 8樓至19樓及 26樓至35樓				22/F to 25/F 22樓至25樓			36/F 36樓			37/F 37樓		
			A	B	C	D	A	B	C	D	B	C	D	A	C	D	A	C	D
Lavatory leading from Kitchen 由廚房通往之 洗手間		Fused Spur Unit/Connection Unit 接線座	1	1			1	1			1			1			1		
Kitchen 廚房	13A Twin Socket Outlet 13A雙位電插座		1	1	1	1	1	1	1	1	1	1	1	4	1	1	4	1	1
	13A Twin Socket Outlet 13A雙位電插座		1	1	-	-	1	1	-	-	1	-	-	-	-	-	-	-	-
	13A Single Socket Outlet 13A單位電插座		7	7	6	6	7	7	6	6	7	6	6	7	6	6	7	6	6
	Door Bell 門鐘		1	1	1	1	1	1	1	1	1	1	1	1	1	1	1	1	1
	Door Phone Handset 對講機		-	-	-	-	-	-	-	-	-	-	-	1	-	-	1	-	-
	20A Double Pole Switch with Pilot Lamp 20A 雙極開關掣		1	1	-	-	1	1	-	-	1	-	-	1	-	-	1	-	-
	Fused Spur Unit/Connection Unit 接線座		3	3	2	2	3	3	2	2	3	2	2	3	2	2	3	2	2
	Drain Point For Washing Machine 去水位供洗衣機		1	1	1	1	1	1	1	1	1	1	1	1	1	1	1	1	1
	Water Point For Washing Machine 來水位供洗衣機		1	1	1	1	1	1	1	1	1	1	1	1	1	1	1	1	1
Stairhood 梯屋	Lighting Switch 燈掣																2		
Flat Roof 平台	13A Weather Proof Single / Twin Socket Outlet 13A 防水單位/雙位電插座		2	2	-	-								1					
Roof 天台	13A Weather Proof Single / Twin Socket Outlet 13A 防水單位/雙位電插座																2	-	-

Notes:

- The residential floors start from 7/F in all towers of the Development.
- There is no Tower 4 in the Development.
- There are no 4/F, 13/F, 14/F, 24/F and 34/F in all towers of the Development.
- There are no 6/F and 19/F in Tower 1 and Tower 2 and no 20/F and 21/F in Tower 6, Tower 7, Tower 9 and Tower 10.
- There are no 2/F in Tower 3, Tower 5, Tower 6, Tower 7, Tower 8, Tower 9 and Tower 10.
- The symbol “-” as shown in the above table denotes “Not Provided”.
- The cells shaded in grey “■” as shown in the above table denotes “Not Applicable”.
- The provision mark with “#” only apply to Flat B of 15/F. There is no Flat Roof for other floors.

備註:

- 發展項目內所有座樓之住宅由7樓開始。
- 發展項目不設第4座。
- 發展項目內所有座樓均不設4樓、13樓、14樓、24樓及34樓。
- 第1座及第2座均不設6樓及19樓；第6座、第7座、第9座及第10座均不設20樓及21樓。
- 第3座、第5座、第6座、第7座、第8座、第9座及第10座均不設2樓。
- 上表內之“-”符號代表“沒有提供”。
- 上表內填上灰色“■”之部分代表“不適用”。
- 註有“#”的數量只適用於15樓B單位，其餘樓層並沒有平台。

## SERVICE AGREEMENTS

### 服務協議

Potable and flushing water is supplied by Water Supplies Department.

Electricity is supplied by The Hongkong Electric Company Limited.

Towngas is supplied by The Hong Kong and China Gas Company Limited.

食水及沖廁水由水務署供應。

電力由香港電燈有限公司供應。

煤氣由香港中華煤氣有限公司供應。

## GOVERNMENT RENT

### 地稅

The Vendor will pay/has paid (as the case may be) all outstanding Government rent in respect of the Land on which the Development is in the course of being erected up to and including the date of the assignment of the residential property.

賣方將會繳付/已繳付(視情況而定)就發展項目所興建於之該地段之地租直至包括住宅物業之買賣成交日期。

## MISCELLANEOUS PAYMENTS BY PURCHASER

### 買方的雜項付款

1. On the delivery of the vacant possession of the residential property to the purchaser, the purchaser is liable to reimburse the owner for the deposits for water, electricity and gas.
2. On that delivery, the purchaser is not liable to pay to the owner a debris removal fee.

Remark:

1. The purchaser shall in fact pay the deposits for water, electricity and gas to the manager of the Development.
2. The purchaser shall in fact pay the debris removal fee to the manager of the Development.

1. 在向買方交付住宅物業在空置情況下的管有權時，買方須負責向擁有人補還水、電力及氣體的按金。
2. 在交付時，買方無須向擁有人支付清理廢料的費用。

備註：

1. 買方事實上須向發展項目的管理人支付水、電力及氣體的按金。
2. 買方事實上須向發展項目的管理人支付清理廢料的費用。

## DEFECT LIABILITY WARRANTY PERIOD

### 欠妥之處的保養責任期

Defect liability warranty period for the residential property and the fittings, finishes and appliances as provided in the agreement for sale and purchase is within six (6) months from the date of completion of the sale and purchase.

按買賣合約規定，住宅物業及其內裝置、裝修物料及設備之欠妥之處的保養責任期為住宅物業之成交日期起計為期六(6)個月內。

### A. The Land Grant requires the Owners of the residential properties in the Development to maintain slope at their own cost

#### 1. The terms of the requirement:

##### (a) Special Conditions No. (18) of the Land Grant stipulates that:-

“(a) Where there is or has been any cutting away, removal or setting back of any land, or any building-up or filling-in or any slope treatment works of any kind whatsoever, whether with or without the prior written consent of the Director, either within the lot or on any Government land, which is or was done for the purpose of or in connection with the formation, levelling or development of the lot or any part thereof or any other works required to be done by the Purchaser under these Conditions, or for any other purpose, the Purchaser shall at his own expense carry out and construct such slope treatment works, retaining walls or other support, protection, drainage or ancillary or other works as shall or may then or at any time thereafter be necessary to protect and support such land within the lot and also any adjacent or adjoining Government or leased land and to obviate and prevent any falling away, landslip or subsidence occurring thereafter. The Purchaser shall at all times during the term hereby agreed to be granted maintain at his own expense the said land, slope treatment works, retaining walls or other support, protection, drainage or ancillary or other works in good and substantial repair and condition to the satisfaction of the Director.

(b) Nothing in sub-clause (a) of this Special Condition shall prejudice the Government’s rights under these Conditions, in particular Special Condition No. (17) hereof.

(c) In the event that as a result of or arising out of any formation, levelling, development or other works done by the Purchaser or owing to any other reason, any falling away, landslip or subsidence occurs at any time, whether in or from any land within the lot or from any adjacent or adjoining Government or leased land, the Purchaser shall at his own expense reinstate and make good the same to the satisfaction of the Director and shall indemnify the Government, its agents and contractors from and against all costs, charges, damages, demands and claims whatsoever which shall or may be made, suffered or incurred through or by reason of such falling away, landslip or subsidence.

(d) In addition to any other rights or remedies herein provided for breach of any of these Conditions, the Director shall be entitled by notice in writing to call upon the Purchaser to carry out, construct and maintain the said land, slope treatment works, retaining walls, or other support, protection, and drainage or ancillary or other works or to reinstate and make good any falling away, landslip or subsidence, and if the Purchaser shall neglect or fail to comply with the notice to the satisfaction of the Director within the period specified therein, the Director may forthwith execute and carry out any necessary works and the Purchaser shall on demand repay to the Government the cost thereof, together with any administrative and professional fees and charges.”

##### (b) Special Conditions No. (23) of the Land Grant stipulates that:-

“(a) The Purchaser shall at his own expense carry out and complete to the satisfaction of the Director such geotechnical investigations and such slope treatment, landslide preventive, mitigation and remedial works on the areas shown coloured green hatched black on the plan marked “PLAN A” annexed hereto (here inafter referred to as “the Green Hatched Black Areas”) as the Director in his absolute discretion may require and shall, at all times during the term hereby agreed to be granted, at his own expense, maintain in good and substantial repair and condition to the satisfaction of the Director the Green Hatched Black Areas including all land, slope treatment works, earth-retaining structures, drainage and any other works therein and thereon. In the event that any landslip, subsidence or falling away occurs within the Green Hatched Black Areas at any time during the term hereby agreed to be granted, the Purchaser shall at his own expense reinstate and make good the same to the satisfaction of the Director together with any adjacent or adjoining areas which, in the opinion of the Director (whose decision shall be final and binding on the Purchaser), have also been affected. The Purchaser shall indemnify the Government, its agents and contractors against all claims, proceedings, costs, damages and expenses whatsoever incurred by reason of such landslip, subsidence or falling away. The Purchaser shall ensure at all times that there shall be no illegal excavation or dumping on the Green Hatched Black Areas and, subject to the prior written approval of the Director, the Purchaser may erect fences or other barriers for the prevention of such illegal excavation or dumping. In addition to any other rights or remedies the Director may have in respect of any breach of these Conditions, the Director may at any time by notice in writing call upon the Purchaser to carry out such geotechnical investigations, slope treatment, landslip preventive, mitigation and remedial works and to maintain, reinstate and make good any land, structure or works affected by such landslip, subsidence or falling away, and if the Purchaser shall neglect or fail to comply with such notice to the satisfaction of the Director within the period specified therein, the Director may, after the expiry of such period, execute and carry out the required works and the Purchaser shall on demand repay to the Government the cost thereof.

(b) Notwithstanding sub-clause (a) of this Special Condition, the obligations and rights of the Purchaser in respect of the Green Hatched Black Areas or any part thereof under this Special Condition shall absolutely determine upon the Government giving to the Purchaser notice to that effect, and no claim for compensation shall be made against the Government or the Director or his authorized officer by the Purchaser in respect of any loss, damage or disturbance suffered or any expense incurred as a result of such determination. However, such determination shall be without prejudice to any rights or remedies of the Government in respect of any antecedent breach, non-performance or non-observance of the said sub-clause (a).”

##### (c) Special Conditions No. (60) of the Land Grant stipulates that:-

“(a) (i) The Purchaser hereby acknowledges that the lot may be affected by landslip hazards including boulder falls arising from the areas to the west of the lot (hereinafter referred to as “the Landslip Hazards Study Areas”) due to the nature of the natural terrain. The location, nature and extent of the Landslip Hazards Study Areas shall be decided by the Director of Civil Engineering and Development whose decision shall be final and binding on the Purchaser. The Purchaser shall on or before the 31st day of December 2008, at his own expense carry out and complete to the satisfaction of the Director geotechnical investigation (hereinafter referred to as “the Investigation”) within the lot and on the Landslip Hazards Study Areas for such hazards. No ground investigation shall be carried out on any Government land outside the Landslip Hazards Study Areas without the prior written consent of the Director.

# MAINTENANCE OF SLOPES

## 斜坡維修

- (ii) A plan approved by the Director of Civil Engineering and Development indicating the location, nature and extent of the Landslip Hazards Study Areas shall be duly registered in the Land Registry against the lot. No transaction (except a tenancy or lease or an agreement for a tenancy or lease permitted by Special Condition No. (9)(c) hereof, a building mortgage under Special Condition No. (9)(d) hereof or such other transactions as the Director may approve) affecting the lot or any part thereof or any building or part of any building erected or to be erected on the lot shall be entered into until after one calendar month from such registration.
- (b) On completion of the Investigation, the Purchaser shall at his own expense carry out any necessary mitigation and stabilisation works within the lot as the Director in his absolute discretion shall require (hereinafter referred to as “the Works”) to protect any building or buildings erected or to be erected on the lot or any part thereof and any residents or occupiers therein and their bona fide guests, visitors and invitees from landslip hazards including boulder falls arising from the Landslip Hazards Study Areas.
- (c) Where it is deemed necessary by the Government or the Purchaser or both to carry out mitigation and stabilisation works (hereinafter referred to as “the Outside Works”) on any Government land including the Landslip Hazards Study Areas (any Government land on or in relation to which the Outside Works are carried out are hereinafter referred to as “the Outside Areas”), the Purchaser shall, upon receipt of the Director’s approval to or request for the Outside Works, at his own expense carry out and complete the Outside Works to the satisfaction of the Director. The Purchaser shall register at his own expense in the Land Registry against the lot a record plan accepted by the Director indicating the location, nature and extent of the Outside Areas and the Outside Works.
- (d) The Purchaser shall at all times during the term hereby agreed to be granted, maintain at his own expense the Works, the Outside Works and the Outside Areas in good substantial repair and conditions to the satisfaction of the Director to ensure the continuing functioning of the Works and the Outside Works. In addition to any rights or remedies the Government may have against the Purchaser for breach of the Purchaser’s obligations to maintain the Works, the Outside Works and the Outside Areas as herein provided, the Director shall be entitled by notice in writing to call upon the Purchaser to carry out such maintenance works as the Director shall in his absolute discretion deem fit. If the Purchaser shall neglect or fail to comply with such notice to the satisfaction of the Director within the period specified therein, the Director may forthwith execute and carry out the required maintenance works and the Purchaser shall on demand repay the Government the cost thereof, together with any administrative and professional fees and charges.
- (e) The Investigation, the Works and the Outside Works shall in all respects comply with the Buildings Ordinance, any regulations made thereunder, any amending legislation and any other relevant Government legislation.
- (f) For the purpose only of carrying out the Investigation, the Works and the Outside Works and inspecting and maintaining the Works, the Outside Works and the Outside Areas, the Purchaser shall have the right of ingress or egress to and from the Outside Areas subject to such terms and conditions as may be imposed by the Director at his sole discretion.

- (g) In the event that as a result of or arising out of any works being carried out or having been carried out pursuant to the terms of this Special Condition any damage is done to any Government land including the Outside Areas or any land outside the lot, the Purchaser shall make good such damage at his own expense and in all respects to the satisfaction of the Director.
  - (h) The Purchaser hereby indemnifies and shall keep indemnified the Government from and against all actions, proceedings, liabilities, claims, costs and demands whatsoever arising out of or incidental to any works being carried out or having been carried out pursuant to the terms of this Special Condition or the omission, neglect or default by the Purchaser to carry out any such works or any landslip hazard including boulder falls from the Outside Areas including but without limitation to any damage to or loss of properties and life or personal injuries or any interference or damage to the graves adjoining or within the Outside Areas.”
2. Each of the owners of the Development is obliged to contribute towards the costs of the maintenance work of the items mentioned in paragraph 1 above.

### B. A plan that shows the slope



**C. Owner's undertaking to maintain any slope in relation to the Development at the owner's own costs**

Not applicable.

**D. The Manager of the Development has the owners' authority to carry out the maintenance work**

Under the DMC, the manager of the Development has the owners' authority to engage suitable qualified personnel to inspect keep and maintain in good substantial repair and condition the Slope Structures (as defined in the DMC) as required by the Land Grant in accordance with "Geoguide 5 - Guide to Slope Maintenance" issued by the Geotechnical Engineering Office as amended from time to time and the Slope Maintenance Manual and with such other guidelines issued from time to time by appropriate Government departments regarding the maintenance of slopes, retaining walls and related structures and to carry out any necessary works in relation thereto and to collect from the Owners in proportion to the Management Shares allocated to their parts of the Lot and the Development such additional sums (in case of insufficient management funds) from time to time to cover all costs lawfully incurred or to be incurred in carrying out such maintenance and repair.

Note: The location of the referred "green hatched black area" is indicated in a plan shown in Section AR of this Sales Brochure.

### A. 批地文件規定發展項目內住宅物業的業主自費維修保養斜坡

#### 1. 該項規定的條款：

##### (a) 批地文件特別條件第(18)條規定：

「(a) 如果現有或曾經作出任何土地切割、移除或退入，或堆積、堆填或任何種類的斜坡處理工程，不論有否經署長事先書面同意，亦不論是在該地段內或任何政府土地內，旨在或有關於該地段或其任何部分之構建、平整或開發，或買方按批地條件須進行的任何其他工程，或作任何其他用途，買方須自費進行與建設為了保護及承托該地段內的土地和任何相鄰或毗連政府土地或已出租土地和為了避免及防止其後發生任何塌方、山泥傾瀉或地陷而在當時或其後任何時間必要的斜坡處理工程、護土牆或其他承托、保護、排水或輔助工程或其他工程。買方須在本批地文件同意授予的年期內一切時候自費維修保養該土地、斜坡處理工程、護土牆或其他承托、保護、排水或輔助工程或其他工程處於修葺良好堅固的狀況，達至署長滿意程度。」

(b) 本特別條件(a)款的任何規定，不影響政府在批地條件下的權利，尤其是特別條件第(17)條下的權利。

(c) 倘若因為任何構建、平整、開發或買方進行的其他工程或任何其他原因而在任何時候導致或引起任何塌方、山泥傾瀉或地陷，不論發生在或來自該地段任何土地或任何相鄰或毗連政府土地或已出租土地，買方須自費復原和修復相關土地以達至署長滿意程度，並對上述塌方、山泥傾瀉或地陷造成政府、其代理人及承判商承受、遭受或產生一切費用、收費、損害、要求及索償作出彌償。

(d) 除了就任何批地條件遭違反而享有批地文件規定的任何其他權利或補救方法外，署長有權發出書面通知要求買方進行、建設及維修保養該土地、斜坡處理工程、護土牆或其他承托、保護及排水或輔助工程或其他工程，或復原和修復任何塌方、山泥傾瀉或地陷。如買方忽視或未能在該通知指定的期限內遵從該通知的要求以達至署長滿意程度，署長可立即執行及進行任何必要工程，而買方須按要項向政府償付該費用連同任何行政費和專業費用及開支。」

##### (b) 批地文件特別條件第(23)條規定：

「(a) 買方須在隨附於本批地文件標明為「圖則A」的圖則上綠色間黑斜線顯示的範圍(下稱「綠色間黑斜線範圍」)，自費進行與完成署長按其絕對酌情權要求的土力勘察、斜坡處理、山泥傾瀉之防止、緩解及補救工程，達至署長滿意程度；並且在本批地文件同意授予的年期內一切時候自費維修保養綠色間黑斜線範圍，包括該範圍之內及之上的一切土地、斜坡處理工程、護土構築物、排水渠及任何其他工程，處於修葺良好堅固的狀況，達至署長滿意程度。如於本批地文件同意授予的年期內任何時候，綠色間黑斜線範圍內發生任何山泥傾瀉、地陷或塌方，買方須自費復原及修復該範圍以及署長認為(其決定為終論並對買方有約束力)亦受影響的任何相鄰或毗連範圍，達至署長滿意程度。對於因上述山泥傾瀉、地陷或塌方而招致的一切索償、法律程序、費用、須付損害賠償及開支，買方須向政府、其代理人及承判商作出彌償。買方須確保在一切時候綠色間黑斜線範圍之上沒有非法挖掘或傾倒之情況。在取得署長事先書面批准的前提下，買方可豎設圍牆或其他障礙物以防止出現上述非法挖掘或傾倒情況。若有違反批地條件的情況發生，署長除就該等違反情況而享有任何其他權利或補救方法之外，可於任何時候以書面通知方式要求買方進行上述土力勘察、斜坡處理、山泥傾瀉之防止、緩解及補救工程，並維修保養、復原及修復受上述山泥傾瀉、地陷或塌方影響的任何土地、構築物或工程。如買方忽視或未能在該通知指定的期限內遵從該通知的要求以達至署長滿意程度，署長可於該期限屆滿後執行及進行必要工程，而買方須按要項向政府償付該費用。」

(b) 儘管有本特別條件(a)款的規定，但買方在本特別條件之下就綠色間黑斜線範圍或其任何部分而有的義務和權利將於政府向買方發出相關通知時完全終止，而買方不得就該項終止導致其遭受的任何損失、損害或干擾或招致的任何開支向政府或署長或其授權人員提出索償。然而，該項終止並不影響政府因買方對上述(a)款的任何先前違反、不履行或不遵守情況而享有的任何權利或補救方法。」

##### (c) 批地文件特別條件第(60)條規定：

「(a) (i) 買方承認因天然地勢的性質，該地段可能受來自該地段以西地方(下稱「山泥傾瀉危害研究區」)的山泥傾瀉(包括巨石下墜)影響。山泥傾瀉研究區的位置、性質及範圍由土木工程拓展署署長決定，其決定為終論並對買方有約束力。買方須在2008年12月31日或之前自費就該等危害在該地段及山泥傾瀉研究區內進行及完成土力勘察(下稱「該勘察」)，達至署長滿意程度。未經署長事先書面同意，不得在山泥傾瀉研究區以外的任何政府土地進行任何土地勘測。」

(ii) 須於土地註冊處就該地段妥為登記一份經由土木工程拓展署署長批准的顯示山泥傾瀉危害研究區的位置、性質及範圍的圖則。任何影響該地段或其任何部分或該地段已建或擬建建築物或其部分的交易(但本批地文件的特別條件第(9)(c)條允許的租賃或租約，或租賃或租約的協議，或本批地文件的特別條件第(9)(d)條之下的建築按揭，或署長批准的其他交易除外)，在上述登記的一個曆月之後方可訂立。

(b) 完成該勘察後，買方須自費於該地段內進行署長按其絕對酌情權要求的任何必要的緩解及鞏固工程(下稱「該等工程」)，以保護該地段或其任何部分的已建或擬建建築物，及其內之任何住戶或佔用人及其真正客人、訪客或受邀人免於來自山泥傾瀉危害研究區的山泥傾瀉危害，包括巨石下墜。

(c) 如政府或買方或兩者均認為有必要於任何政府土地(包括山泥傾瀉研究區)進行緩解及鞏固工程(下稱「外區工程」)(須於其上進行或須就其進行外區工程的任何政府土地下稱「外區」)，買方須於收到署長就進行外區工程的批准或要求後，自費進行及完成外區工程以達至署長滿意程度。買方須自費於土地註冊處就該地段註冊一份獲署長接納的顯示外區及外區工程的位置、性質及範圍的圖則。

(d) 買方須於本批地文件同意授予的年期內一切時候自費維修保養該等工程、外區工程及外區處於修葺良好堅固的狀況，達至署長滿意程度，以確保該等工程及外區工程持續運作。若買方違反本條規定的關於維修保養該等工程、外區工程及外區的義務，政府除就該等違反情況而享有的任何權利或補救方法之外，署長可透過書面通知方式要求買方進行署長按其絕對酌情權認為適當的維修保養工程。如買方忽視或未能在該通知指定的期限內遵從該項通知的要求以達至署長滿意程度，署長可立即執行及進行必要的維修保養工程，而買方須按要項向政府償付該費用，連同任何行政和專業費用及收費。

(e) 該勘察、該等工程及外區工程須在各方面遵守《建築物條例》、根據該條例制定的任何規例、任何修訂立法以及任何其他有關的政府立法。

(f) 僅就進行該勘察、該等工程及外區工程和檢查及維修保養該等工程、外區工程及外區而言，買方有權進出外區，惟須受署長按其獨自酌情權施加的條款及條件之制約。

(g) 如由於按照本特別條件的條款正在進行或已經進行的任何工程，導致或引起任何政府土地(包括外區)或該地段範圍外任何土地受到任何損害，買方須自費修復該等損害並於各方面達至署長滿意程度。



- (h) 對於按照本特別條件的條款正在進行或已經進行的任何工程，或買方遺漏、忽視或沒有進行任何該工程，或來自外區的任何山泥傾瀉危害(包括巨石下墜)，包括但不限於對財產及人命造成的任何損害或損失或人身傷害，或對與外區毗連或在外區之內的墳墓造成的任何干擾或損害，因而引起或附帶的一切訴訟、法律程序、責任、索償、費用和要求，買方特此向政府作出彌償並保持政府獲得彌償。」

2. 發展項目的每名業主均有義務分擔以上第1段所述項目的維修保養工作費用。

## B. 顯示斜坡的圖則

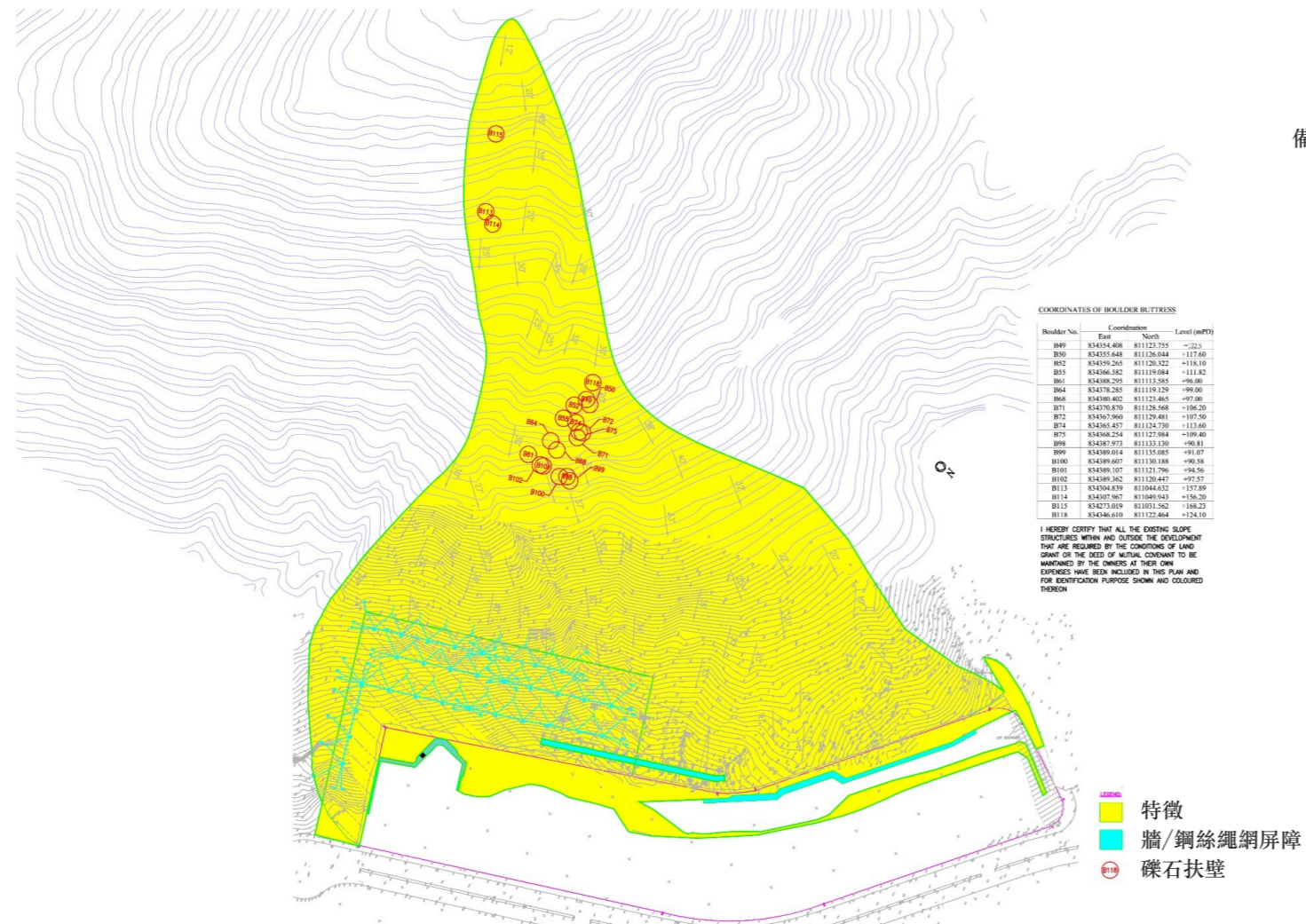

## C. 業主自費就發展項目維修保養任何斜坡的承諾

不適用。

## D. 發展項目的管理人獲得業主授權進行維修保養工作

根據大廈公契，發展項目的管理人獲得業主授權聘請適當合資格的人士，根據土木工程處發出的岩土指南第五冊《斜坡維修指南》(以不時修訂的版本為準)，以及《斜坡維修手冊》和相關政府部門就斜坡、護土牆及相關構築物不時發出的其他指引，按照批地文件的規定檢查、保持和維修保養斜坡結構(定義見公契)，使之處於修葺良好堅固的狀況，並對斜坡結構進行任何必要的工程，且根據業主就其在該地段及發展項目所佔部分而獲分配的管理份數之比例不時向業主收取額外款項(如果管理基金出現不足)，從而彌補由於進行上述維修保養及修理而合法地發生或將會發生的一切費用。

備註：以上提及的“綠色間黑斜線顯示的範圍”之位置於本售樓說明書AR節中以圖則顯示。

# MODIFICATION 修訂

No application to the Government for a modification of the Land Grant for this Development is underway.

本發展項目現時並沒有向政府提出申請修訂批地文件。

### 1. Industrial Noise Impact Assessment and Mitigation Measures Proposed at the Development

The Development at Ap Lei Chau Inland Lot 129 is situated to the west of the Ap Lei Chau Boatyards (“Boatyards”) separated by the Ap Lei Chau Praya Road. Industrial noise generated by the daily operations of Boatyards is hereby obligatorily addressed. Industrial noise impact assessment has been carried out by the Developer and noise mitigation measures (as mentioned below) are provided at the habitable rooms of the Development.

1. 1.5m long vertical fin for mitigating the noise level at Tower 2 of the Development;
2. Non-openable window/curtain wall on the whole frontage of the Development directly facing the Boatyards, except for the units at simplex levels to be provided with the mitigation measures mentioned at item 3 below; and
3. Provision of 1.5m high solid parapet wall at lower simplex unit of all towers.

The residents of the Development should not alter the noise mitigation measures mentioned above of your own unit which will adversely affect the noise mitigating performance and should be responsible for any subsequent liability of such alteration.

For details of such noise mitigation measures and related units in the Development, prospective purchasers should refer to the Noise Impact Assessment Report dated April 2010 (Reference Number: SHKALCREEI00) (the “NIAR”). Copy of the NIAR will be annexed to the Deed of Mutual Covenant Incorporating Management Agreement and will also be available for free inspection upon request by prospective purchasers at the sales office during its opening hours (photocopies will be available on payment of photocopying charges).

### 2. Gondola Systems

Gondola systems of the residential towers in the Development may operate in the airspace above the flat roof, roof or stairhood (and the top of stairhood) forming part of a residential property.

### 3. Lift Lobby

The lift lobby to the following residential properties (the “Lobby” which is bound by yellow broken lines on the floor plans for the following floors in this Sales Brochure), which form part of the corresponding residential properties, also serves as a fireman’s lift lobby :-

Tower 1 : Flat A on 7th to 12th, 15th to 18th, 20th to 23rd, 25th to 33rd and 35th to 38th floors;  
Flat B on 7th to 12th, 15th to 18th, 22nd to 23rd, 25th to 33rd and 35th to 36th floors;

Tower 2: Flat A on 7th to 12th, 15th to 18th, 20th to 23rd, 25th to 33rd and 35th to 38th floors; and  
Flat B on 7th to 12th, 15th to 18th, 22nd to 23rd, 25th to 33rd and 35th to 36th floors.

The use and enjoyment of the Lobby may be subject to the applicable laws and regulations with respect to the use of the fireman’s lift lobby (such as to allow the firemen to access the Lobby for the purposes of fire fighting and rescue).

### 1. 發展項目的工業噪音影響評估及噪音緩解措施

鴨脷洲內地第129段的發展項目位於鴨脷洲海傍道的鴨脷洲船廠(「船廠」)的西面。因此，船廠於日間所產生的工業噪音必須加以處理。發展商已為此進行工業噪音影響評估，並於發展項目的可居住房間提供噪音緩解措施(如下所述)。

1. 提供1.5米長豎向鰭以減輕發展項目第二座的噪音水平；
2. 除了於發展項目的特色層單位內提供下列第3項所述的噪音緩解措施外，還於直接面向船廠的整個發展項目臨街面上設有不可開啟的窗戶/玻璃幕牆；及
3. 於發展項目的所有座數低層特色戶單位提供1.5米高實心護牆。

本發展項目的居民不應更改其擁有單位的上述噪音緩解措施，這會對噪音緩解表現構成不良影響，並須對該等變更負上相關法律責任。

為了解噪音緩解措施詳情及發展項目內相關單位，準買家應參閱2010年4月的噪音影響評估報告(參考編號：SHKALCREEI00)(「NIAR」)。噪音影響評估報告副本將隨附於大廈公契及管理協議，準買家並可於售樓處在其關於時間內要求免費查閱(可於支付影印費後取得影印本)。

### 2. 吊船系統

發展項目住宅大樓之吊船系統可能會在屬於住宅物業一部分之平台、天台或梯屋(及梯屋頂)上空操作。

### 3. 升降機大堂

以下住宅物業的升降機大堂(「該大堂」)，其面積在本售樓說明書中以下樓層的樓面平面圖上以黃色斷線包圍)，構成相應住宅物業的一部分，亦同時用作為消防員升降機大堂：

第1座：A室於7樓至12樓、15樓至18樓、20樓至23樓、25樓至33樓、35樓至38樓；  
B室於7樓至12樓、15樓至18樓、22樓至23樓、25樓至33樓、35樓至36樓；

第2座：A室於7樓至12樓、15樓至18樓、20樓至23樓、25樓至33樓、35樓至38樓；及  
B室於7樓至12樓、15樓至18樓、22樓至23樓、25樓至33樓、35樓至36樓。

該大堂的使用與享用須受涉及消防員升降機大堂之使用(例如讓消防員進出該大堂以便進行救火救援工作)的適用法律及規例所制約。

## WEBSITE ADDRESS 互聯網網站的網址

The website address designated by the Vendor for the Development :  
[www.larvotto.com.hk](http://www.larvotto.com.hk)

賣方就發展項目指定的互聯網網站的網址：  
[www.larvotto.com.hk](http://www.larvotto.com.hk)

# INFORMATION IN APPLICATION FOR CONCESSION ON GROSS FLOOR AREA OF BUILDING

## 申請建築物總樓面面積寬免的資料

### Breakdown of GFA Concessions Obtained for All Features

- Latest information on breakdown of GFA concessions as shown on the general building plans submitted to and approved by the Building Authority (BA) prior to the printing of the sales brochure is tabulated below. Information marked (#) may be based on information provided by the authorized person if the sales brochure is printed prior to submission of the final amendment plans to the BA. The breakdown of GFA concessions may be subject to further changes until final amendment plans are submitted to and approved by the BA prior to the issuance of the occupation permit for the development.

		Area (m <sup>2</sup> )
Disregarded GFA under Building (Planning) Regulations 23(3)(b)		
1.(#)	Carpark and loading/ unloading area excluding public transport terminus	22,921.539
2.	<b>Plant rooms and similar services</b>	
2.1	Mandatory feature or essential plant room, area of which is limited by respective Practice Notes for Authorized Persons, Registered Structural Engineers and Registered Geotechnical Engineers (PNAP) or regulation such as lift machine room, telecommunications and broadcasting (TBE) room, refuse storage and material recovery chamber, etc.	372.627
2.2(#)	Mandatory feature or essential plant room, area of which is NOT limited by any PNAP or regulation such as room occupied solely by fire services installations (FSI) and equipment, meter room, transformer room, potable and flushing water tank, etc.	6120.102
2.3	Non-mandatory or non-essential plant room such as air-conditioning plant room, air handling flat (AHU) room, etc.	337.877
Green Features under Joint Practice Notes 1 and 2		
3.	Balcony	1960.469
4.	Wider common corridor and lift lobby	751.678
5.	Communal sky garden	584.898
6.	Acoustic fin	-
7.	Wing wall, wind catcher and funnel	-
8.	Non-structure prefabricated external wall	-
9.	Utility Platform	520.5
10.	Noise barrier	12.6
Amenity Features		
11.	Counter, office, store, guard room and lavatory for watchman and management staff, Owners' Corporation Office	119.887
12.	Residential Recreational facilities including void, plant room, swimming pool filtration plant room, covered walkway etc serving solely the recreational facilities	4857.718
13.	Covered landscaped and play area	3047.375
14.	Horizontal screens/ cover walkways, trellis	-
15.	Larger lift shaft	3644.296

		Area (m <sup>2</sup> )
Amenity Features		
16.	Chimney shaft	-
17.	Other non-mandatory or non-essential plant room, such as boiler room, satellite master antenna television (SMATV) room	71.791
18.(#)	Pipe duct, air duct for mandatory feature or essential plant room	568.666
19.	Pipe duct, air duct for non-mandatory or non-essential plant room	4.704
20.	Plant room, pipe duct, air duct for environmentally friendly system and feature	-
21.	Void in duplex domestic flat and house	-
22.	Projections such as air-conditioning box and platform with a projection of more than 750mm from the external wall	-
Other Exempted Items		
23.(#)	Refuge floor including refuge floor cum sky garden	1734.69
24.(#)	Other projections	-
25.	Public transport terminus	-
26.(#)	Party structure and common staircase	-
27.(#)	Horizontal area of staircase, lift shaft and vertical duct solely serving floor accepted as not being accountable for GFA.	-
28.(#)	Public passage	-
29.	Covered set back area	-
Bonus GFA		
30.	Bonus GFA	-

**Note:**

The above table is based on the requirements as stipulated in the Practice Note for Authorized Persons, Registered Structural Engineers and Registered Geotechnical Engineers ADM-2 issued by the Building Department. The Buildings Department may revise such requirements from time to time as appropriate.

The environmental assessment of building and information on the estimated energy performance or consumption for the common parts of the development.

The approved general building plans of this development are not subject to the requirements stipulated in the Practice Note for Authorized Persons, Registered Structural Engineers and Registered Geotechnical Engineers APP-151 issued by the Building Authority. Environmental Assessment and information on the estimated energy performance or consumption for the common parts of this development were not required to be submitted to the Building Authority as a prerequisite for the granting of gross floor area concessions.

# INFORMATION IN APPLICATION FOR CONCESSION ON GROSS FLOOR AREA OF BUILDING

## 申請建築物總樓面面積寬免的資料

### 獲寬免總樓面面積的設施分項

- 於印製售樓說明書前呈交予並已獲建築事務監督批准的建築圖則上有關總樓面面積寬免的分項的最新資料，請見下表。如印製售樓說明書時尚未呈交最終修訂圖則予建築事務監督，則有(#)號的資料可以由認可人士提供的資料作為基礎。直至最終修訂圖則於發出佔用許可證前呈交予並獲建築事務監督批准前，以下分項資料仍可能有所修改。

		面積(平方米)
根據《建築物(規劃)規例》第23(3)(b)條不計算的總樓面面積		
1.(#)	停車場及上落客貨地方(公共交通總站除外)	22,921.539
2.	<b>機房及相類設施</b>	
2.1	所佔面積受相關《認可人士、註冊結構工程師及註冊岩土工程師作業備考》或規例限制的強制性設施或必要機房，例如升降機機房、電訊及廣播設備室、垃圾及物料回收房等	372.627
2.2(#)	所佔面積不受任何《認可人士、註冊結構工程師及註冊岩土工程師作業備考》或規例限制的強制性設施或必要機房，例如僅供消防裝置及設備佔用的房間、電錶房、電力變壓房、食水及鹹水缸等	6120.102
2.3	非強制性或非必要機房，例如空調機房、風櫃房等	337.877
根據聯合作業備考第1號及第2號提供的環保設施		
3.	露台	1960.469
4.	加闊的公用走廊及升降機大堂	751.678
5.	公用空中花園	584.898
6.	隔聲牆	-
7.	翼牆、捕風器及風斗	-
8.	非結構預製外牆	-
9.	工作平台	520.5
10.	隔音屏障	12.6

註：

上述表格是根據屋宇署所發出的《認可人士、註冊結構工程師及註冊岩土工程師作業備考》ADM-2規定的要求而制訂的。屋宇署會按實際需要不時更改有關要求。

有關建築物的環境評估及發展項目的公用部份的預計能量表現或消耗資料。

本發展項目的經批准一般建築圖則不受由建築事務監督發出的《認可人士、註冊結構工程師及註冊岩土工程師作業備考》APP-151規定所規限。本發展項目的環境評估及公用部份的預計能量表現或消耗的資料無須呈交建築事務監督，以作為批予總樓面面積寬免的先決條件。

		面積(平方米)
適意設施		
11.	供保安人員和管理處員工使用的櫃枱、辦公室、儲物室、警衛室和廁所、業主立案法團辦公室	119.887
12.	住宅康樂設施，包括僅供康樂設施使用的中空、機房、游泳池的濾水器機房、有蓋人行道等	4857.718
13.	有上蓋的園景區及遊樂場	3047.375
14.	橫向屏障/有蓋人行道、花棚	-
15.	擴大升降機井道	3644.296
16.	煙囪管道	-
17.	其他非強制性或非必要機房、例如鍋爐房、衛星電視共用天線房	71.791
18.(#)	強制性設施或必要機房所需的管槽、氣槽	568.666
19.	非強制性設施或非必要機房所需的管槽、氣槽	4.704
20.	環保系統及設施所需的機房、管槽及氣槽	-
21.	複式住宅單位及洋房的中空	-
22.	伸出物，如空調機箱及伸出外牆超過750毫米的平台	-
其他寬面項目		
23.(#)	庇護層，包括庇護層兼空中花園	1734.69
24.(#)	其他伸出物	-
25.	公共交通總站	-
26.(#)	共用構築物及樓梯	-
27.(#)	僅供獲接納不計入總樓面面積的樓層使用的樓梯、升降機槽及垂直管道的水平面積	-
28.(#)	公眾通道	-
29.	因建築物後移導致的覆蓋面積	-
額外總樓面面積		
30.	額外總樓面面積	-

## DATE OF PRINTING OF SALES BROCHURE 售樓說明書印製日期

Date of printing of this Sales Brochure : 7 August 2017.

本售樓說明書印製日期：2017年8月7日。

## POSSIBLE FUTURE CHANGE 日後可能出現的改變

There may be future changes to the Development and the surrounding areas.

發展項目及其周邊地區日後可能出現改變。

# EXAMINATION RECORD

## 檢視紀錄

Examination/Revision Date 檢視/修改日期	Revision Made (If no revision is required, please state "no revision made") 所作修改 (如無須作出修改，請註明「並無作出修改」)	
	Page Number 頁次	Revision Made 所作修改
1 <sup>st</sup> November, 2017 2017年11月1日	AH	Location Plan of The Development is updated. 更新發展項目的所在位置圖。
	AJ	Outline Zoning Plan Relating to The Development is updated. 更新關乎發展項目的分區計劃大綱圖。



EXAMINATION RECORD  
檢視紀錄



