

Area of residential properties in the development

發展項目中的住宅物業的面積

Description of Residential Property 物業的描述			Saleable Area (including balcony, utility platform and verandah, if any) sq. metre (sq. ft.) 實用面積 (包括露台、工作平台及陽台(如有))平方米(平方呎)	Area of other specified items (Not included in the Saleable Area) sq. metre (sq. ft.) 其他指明項目的面積(不計算入實用面積) 平方米(平方呎)									
Tower Number 座號	Floor 樓層	Flat 單位		Air-conditioning Plant Room 空調機房	Bay Window 窗台	Cockloft 閣樓	Flat Roof 平台	Garden 花園	Parking Space 停車位	Roof 天台	Stairhood 梯屋	Terrace 前庭	Yard 庭院
Tower 1 座	G/F 地下	A	163.472 (1,760) (Balcony 露台: -(-))(Utility Platform 工作平台: -(-))(Verandah 陽台: -(-))	-	-	-	4,094 (44)	81,727 (880)	-	-	-	-	-
		B	141.519 (1,523) (Balcony 露台: -(-))(Utility Platform 工作平台: -(-))(Verandah 陽台: -(-))	-	-	-	3,067 (33)	59,348 (639)	-	-	-	-	-
		C	109.789 (1,182) (Balcony 露台: -(-))(Utility Platform 工作平台: -(-))(Verandah 陽台: -(-))	-	-	-	-	25,413 (274)	-	-	-	-	-
		D	39.254 (423) (Balcony 露台: -(-))(Utility Platform 工作平台: -(-))(Verandah 陽台: -(-))	-	-	-	-	-	-	-	-	-	-
	1/F 1樓	A	180.707 (1,945) (Balcony 露台: 17.228(185))(Utility Platform 工作平台: -(-))(Verandah 陽台: -(-))	-	-	-	-	-	-	-	-	-	-
		B	148.550 (1,599) (Balcony 露台: 5.634(61))(Utility Platform 工作平台: 1.724(19))(Verandah 陽台: -(-))	-	-	-	-	-	-	-	-	-	-
		C	101.015 (1,087) (Balcony 露台: -(-))(Utility Platform 工作平台: 1.680(18))(Verandah 陽台: -(-))	-	-	-	4,085 (44)	-	-	-	-	-	-
		D	87.384 (941) (Balcony 露台: -(-))(Utility Platform 工作平台: -(-))(Verandah 陽台: -(-))	-	-	-	3,816 (41)	-	-	-	-	-	-
	2/F - 3/F, 5/F & 6/F 2樓-3樓、 5樓及6樓	A	180.707 (1,945) (Balcony 露台: 17.228(185))(Utility Platform 工作平台: -(-))(Verandah 陽台: -(-))	-	-	-	-	-	-	-	-	-	-
		B	148.550 (1,599) (Balcony 露台: 5.634(61))(Utility Platform 工作平台: 1.724(19))(Verandah 陽台: -(-))	-	-	-	-	-	-	-	-	-	-
		C	104.667 (1,127) (Balcony 露台: 3.652(39))(Utility Platform 工作平台: 1.680(18))(Verandah 陽台: -(-))	-	-	-	-	-	-	-	-	-	-
		D	91.284 (983) (Balcony 露台: 3.421(37))(Utility Platform 工作平台: -(-))(Verandah 陽台: -(-))	-	-	-	-	-	-	-	-	-	-
	7/F 7樓	A	178.374 (1,920) (Balcony 露台: 17.229(185))(Utility Platform 工作平台: -(-))(Verandah 陽台: -(-))	-	-	-	-	-	-	137,345 (1,478)	-	-	-
		B	148.748 (1,601) (Balcony 露台: 5.634(61))(Utility Platform 工作平台: 1.724(19))(Verandah 陽台: -(-))	-	-	-	-	-	-	124,549 (1,341)	-	-	-
		C	99.874 (1,075) (Balcony 露台: 3.652(39))(Utility Platform 工作平台: -(-))(Verandah 陽台: -(-))	-	-	-	-	-	-	67,698 (729)	-	-	-
		D	91.284 (983) (Balcony 露台: 3.421(37))(Utility Platform 工作平台: -(-))(Verandah 陽台: -(-))	-	-	-	-	-	-	56,078 (604)	-	-	-

- Remarks:
- The areas in square feet have been converted from square metres based on a conversion rate of 1 square metre = 10.764 square feet and rounded off to the nearest integer.
 - 4/F is omitted.

- 住宅物業的實用面積是按《一手住宅物業銷售條例》第8條計算得出的。
- 在構成住宅物業的一部分的範圍內的每一露台、工作平台及陽台(如有)之樓面面積是按《一手住宅物業銷售條例》第8條計算得出的。
- 其他指明項目的面積(不計算入實用面積)是按《一手住宅物業銷售條例》附表2第2部計算得出的。

備註:

- 以平方呎列出的面積由以平方米列出的面積以1平方米=10.764平方呎換算,並以四捨五入至整數。
- 不設4樓。

Area of residential properties in the development

發展項目中的住宅物業的面積

Description of Residential Property 物業的描述			Saleable Area (including balcony, utility platform and verandah, if any) sq. metre (sq. ft.) 實用面積 (包括露台、工作平台及陽台(如有))平方米(平方呎)	Area of other specified items (Not included in the Saleable Area) sq. metre (sq. ft.) 其他指明項目的面積(不計算入實用面積) 平方米(平方呎)									
Tower Number 座號	Floor 樓層	Flat 單位		Air-conditioning Plant Room 空調機房	Bay Window 窗台	Cockloft 閣樓	Flat Roof 平台	Garden 花園	Parking Space 停車位	Roof 天台	Stairhood 梯屋	Terrace 前庭	Yard 庭院
Tower 2 座	G/F 地下	A	161.271 (1,736) (Balcony 露台: -(-))(Utility Platform 工作平台: -(-))(Verandah 陽台: -(-))	-	-	-	-	81.800 (880)	-	-	-	-	-
		B	161.175 (1,735) (Balcony 露台: -(-))(Utility Platform 工作平台: -(-))(Verandah 陽台: -(-))	-	-	-	-	52.790 (568)	-	-	-	-	-
		C	123.910 (1,334) (Balcony 露台: -(-))(Utility Platform 工作平台: -(-))(Verandah 陽台: -(-))	-	-	-	-	24.660 (265)	-	-	-	-	-
		D	157.807 (1,699) (Balcony 露台: -(-))(Utility Platform 工作平台: -(-))(Verandah 陽台: -(-))	-	-	-	-	28.785 (310)	-	-	-	-	-
	1/F 1樓	A	170.255 (1,833) (Balcony 露台: 6.834(74))(Utility Platform 工作平台: 2.004(22))(Verandah 陽台: -(-))	-	-	-	-	-	-	-	-	-	-
		B	170.367 (1,834) (Balcony 露台: 6.834(74))(Utility Platform 工作平台: 2.004(22))(Verandah 陽台: -(-))	-	-	-	-	-	-	-	-	-	-
		C	102.866 (1,107) (Balcony 露台: -(-))(Utility Platform 工作平台: 1.760(19))(Verandah 陽台: -(-))	-	-	-	6.285 (68)	-	-	-	-	-	-
		D	105.236 (1,133) (Balcony 露台: -(-))(Utility Platform 工作平台: 1.760(19))(Verandah 陽台: -(-))	-	-	-	9.780 (105)	-	-	-	-	-	-
		E	83.054 (894) (Balcony 露台: -(-))(Utility Platform 工作平台: -(-))(Verandah 陽台: -(-))	-	-	-	11.816 (127)	-	-	-	-	-	-
	2/F - 3/F, 5/F & 6/F 2樓-3樓、 5樓及6樓	A	170.255 (1,833) (Balcony 露台: 6.834(74))(Utility Platform 工作平台: 2.004(22))(Verandah 陽台: -(-))	-	-	-	-	-	-	-	-	-	-
		B	170.367 (1,834) (Balcony 露台: 6.834(74))(Utility Platform 工作平台: 2.004(22))(Verandah 陽台: -(-))	-	-	-	-	-	-	-	-	-	-
		C	106.472 (1,146) (Balcony 露台: 3.606(39))(Utility Platform 工作平台: 1.760(19))(Verandah 陽台: -(-))	-	-	-	-	-	-	-	-	-	-
		D	108.890 (1,172) (Balcony 露台: 3.654(39))(Utility Platform 工作平台: 1.760(19))(Verandah 陽台: -(-))	-	-	-	-	-	-	-	-	-	-
		E	89.899 (968) (Balcony 露台: 3.097(33))(Utility Platform 工作平台: 3.748(40))(Verandah 陽台: -(-))	-	-	-	-	-	-	-	-	-	-
	7/F 7樓	A	170.627 (1,837) (Balcony 露台: 6.834(74))(Utility Platform 工作平台: 2.004(22))(Verandah 陽台: -(-))	-	-	-	-	-	-	130.305 (1,403)	-	-	-
		B	170.444 (1,835) (Balcony 露台: 6.834(74))(Utility Platform 工作平台: 2.004(22))(Verandah 陽台: -(-))	-	-	-	-	-	-	153.399 (1,651)	-	-	-
		C	140.260 (1,510) (Balcony 露台: 3.606(39))(Utility Platform 工作平台: -(-))(Verandah 陽台: -(-))	-	-	-	-	-	-	104.059 (1,120)	-	-	-
		D	137.712 (1,482) (Balcony 露台: 3.654(39))(Utility Platform 工作平台: -(-))(Verandah 陽台: -(-))	-	-	-	5.241 (56)	-	-	106.004 (1,141)	-	-	-

- The saleable area of the residential properties is calculated in accordance with Section 8 of the Residential Properties (First-hand Sales) Ordinance.
- The floor area of each of the balcony, utility platform and verandah, if any, to the extent that it forms part of a residential property, is calculated in accordance with Section 8 of the Residential Properties (First-hand Sales) Ordinance.
- The areas of other specified items (not included in the saleable area) are calculated in accordance with Part 2 of Schedule 2 to the Residential Properties (First-hand Sales) Ordinance.

Remarks:

- The areas in square feet have been converted from square metres based on a conversion rate of 1 square metre = 10.764 square feet and rounded off to the nearest integer.
- 4/F is omitted.

- 住宅物業的實用面積是按《一手住宅物業銷售條例》第8條計算得出的。
- 在構成住宅物業的一部分的範圍內的每一露台、工作平台及陽台(如有)之樓面面積是按《一手住宅物業銷售條例》第8條計算得出的。
- 其他指明項目的面積(不計算入實用面積)是按《一手住宅物業銷售條例》附表2第2部計算得出的。

備註:

- 以平方呎列出的面積由以平方米列出的面積以1平方米=10.764平方呎換算,並以四捨五入至整數。
- 不設4樓。

Area of residential properties in the development

發展項目中的住宅物業的面積

Description of Residential Property 物業的描述			Saleable Area (including balcony, utility platform and verandah, if any) sq. metre (sq. ft.) 實用面積 (包括露台、工作平台及陽台(如有))平方米(平方呎)	Area of other specified items (Not included in the Saleable Area) sq. metre (sq. ft.) 其他指明項目的面積(不計算入實用面積) 平方米(平方呎)									
Tower Number 座號	Floor 樓層	Flat 單位		Air-conditioning Plant Room 空調機房	Bay Window 窗台	Cockloft 閣樓	Flat Roof 平台	Garden 花園	Parking Space 停車位	Roof 天台	Stairhood 梯屋	Terrace 前庭	Yard 庭院
Tower 3 座	G/F 地下	A	161.347 (1,737) (Balcony 露台: -)(Utility Platform 工作平台: -)(Verandah 陽台: -)	-	-	-	-	72.738 (783)	-	-	-	-	-
		B	168.971 (1,819) (Balcony 露台: -)(Utility Platform 工作平台: -)(Verandah 陽台: -)	-	-	-	-	96.151 (1,035)	-	-	-	-	-
		C	120.406 (1,296) (Balcony 露台: -)(Utility Platform 工作平台: -)(Verandah 陽台: -)	-	-	-	-	52.949 (570)	-	-	-	-	-
		D	157.086 (1,691) (Balcony 露台: -)(Utility Platform 工作平台: -)(Verandah 陽台: -)	-	-	-	-	26.176 (282)	-	-	-	-	-
	1/F 1樓	A	170.332 (1,833) (Balcony 露台: 6.834(74))(Utility Platform 工作平台: 2.004(22))(Verandah 陽台: -)	-	-	-	-	-	-	-	-	-	-
		B	177.162 (1,907) (Balcony 露台: 6.894(74))(Utility Platform 工作平台: 1.584(17))(Verandah 陽台: -)	-	-	-	-	-	-	-	-	-	-
		C	101.853 (1,096) (Balcony 露台: -)(Utility Platform 工作平台: -)(Verandah 陽台: -)	-	-	-	4.913 (53)	-	-	-	-	-	-
		D	105.236 (1,133) (Balcony 露台: -)(Utility Platform 工作平台: 1.760(19))(Verandah 陽台: -)	-	-	-	9.780 (105)	-	-	-	-	-	-
		E	83.054 (894) (Balcony 露台: -)(Utility Platform 工作平台: -)(Verandah 陽台: -)	-	-	-	11.702 (126)	-	-	-	-	-	-
	2/F - 3/F, 5/F & 6/F 2樓-3樓、 5樓及6樓	A	170.332 (1,833) (Balcony 露台: 6.834(74))(Utility Platform 工作平台: 2.004(22))(Verandah 陽台: -)	-	-	-	-	-	-	-	-	-	-
		B	177.162 (1,907) (Balcony 露台: 6.894(74))(Utility Platform 工作平台: 1.584(17))(Verandah 陽台: -)	-	-	-	-	-	-	-	-	-	-
		C	108.930 (1,173) (Balcony 露台: 3.814(41))(Utility Platform 工作平台: 3.263(35))(Verandah 陽台: -)	-	-	-	-	-	-	-	-	-	-
		D	108.890 (1,172) (Balcony 露台: 3.654(39))(Utility Platform 工作平台: 1.760(19))(Verandah 陽台: -)	-	-	-	-	-	-	-	-	-	-
		E	89.899 (968) (Balcony 露台: 3.097(33))(Utility Platform 工作平台: 3.748(40))(Verandah 陽台: -)	-	-	-	-	-	-	-	-	-	-
	7/F 7樓	A	170.702 (1,837) (Balcony 露台: 6.834(74))(Utility Platform 工作平台: 2.004(22))(Verandah 陽台: -)	-	-	-	-	-	-	122.396 (1,317)	-	-	-
		B	175.181 (1,886) (Balcony 露台: 6.893(74))(Utility Platform 工作平台: 1.584(17))(Verandah 陽台: -)	-	-	-	-	-	-	143.426 (1,544)	-	-	-
		C	146.463 (1,577) (Balcony 露台: 3.814(41))(Utility Platform 工作平台: 3.262(35))(Verandah 陽台: -)	-	-	-	-	-	-	114.117 (1,228)	-	-	-
		D	137.713 (1,482) (Balcony 露台: 3.654(39))(Utility Platform 工作平台: -)(Verandah 陽台: -)	-	-	-	5.241 (56)	-	-	106.004 (1,141)	-	-	-

- The saleable area of the residential properties is calculated in accordance with Section 8 of the Residential Properties (First-hand Sales) Ordinance.
- The floor area of each of the balcony, utility platform and verandah, if any, to the extent that it forms part of a residential property, is calculated in accordance with Section 8 of the Residential Properties (First-hand Sales) Ordinance.
- The areas of other specified items (not included in the saleable area) are calculated in accordance with Part 2 of Schedule 2 to the Residential Properties (First-hand Sales) Ordinance.

Remarks:

- The areas in square feet have been converted from square metres based on a conversion rate of 1 square metre = 10.764 square feet and rounded off to the nearest integer.
- 4/F is omitted.

- 住宅物業的實用面積是按《一手住宅物業銷售條例》第8條計算得出的。
- 在構成住宅物業的一部分的範圍內的每一露台、工作平台及陽台(如有)之樓面面積是按《一手住宅物業銷售條例》第8條計算得出的。
- 其他指明項目的面積(不計算入實用面積)是按《一手住宅物業銷售條例》附表2第2部計算得出的。

備註:

- 以平方呎列出的面積由以平方米列出的面積以1平方米=10.764平方呎換算,並以四捨五入至整數。
- 不設4樓。

Area of residential properties in the development

發展項目中的住宅物業的面積

Description of Residential Property 物業的描述			Saleable Area (including balcony, utility platform and verandah, if any) sq. metre (sq. ft.) 實用面積 (包括露台、工作平台及陽台(如有))平方米(平方呎)	Area of other specified items (Not included in the Saleable Area) sq. metre (sq. ft.) 其他指明項目的面積(不計算入實用面積) 平方米(平方呎)									
Tower Number 座號	Floor 樓層	Flat 單位		Air-conditioning Plant Room 空調機房	Bay Window 窗台	Cockloft 閣樓	Flat Roof 平台	Garden 花園	Parking Space 停車位	Roof 天台	Stairhood 梯屋	Terrace 前庭	Yard 庭院
Tower 5 座	G/F 地下	A	168.970 (1,819) (Balcony 露台: -(-))(Utility Platform 工作平台: -(-))(Verandah 陽台: -(-))	-	-	-	-	125.552 (1,351)	-	-	-	-	-
		B	160.877 (1,732) (Balcony 露台: -(-))(Utility Platform 工作平台: -(-))(Verandah 陽台: -(-))	-	-	-	-	100.764 (1,085)	-	-	-	-	-
		C	157.087 (1,691) (Balcony 露台: -(-))(Utility Platform 工作平台: -(-))(Verandah 陽台: -(-))	-	-	-	-	78.298 (843)	-	-	-	-	-
		D	120.405 (1,296) (Balcony 露台: -(-))(Utility Platform 工作平台: -(-))(Verandah 陽台: -(-))	-	-	-	-	63.225 (681)	-	-	-	-	-
	1/F 1樓	A	177.161 (1,907) (Balcony 露台: 6.894(74))(Utility Platform 工作平台: 1.583(17))(Verandah 陽台: -(-))	-	-	-	-	-	-	-	-	-	-
		B	170.618 (1,837) (Balcony 露台: 6.834(74))(Utility Platform 工作平台: 2.761(30))(Verandah 陽台: -(-))	-	-	-	-	-	-	-	-	-	-
		C	105.235 (1,133) (Balcony 露台: -(-))(Utility Platform 工作平台: 1.760(19))(Verandah 陽台: -(-))	-	-	-	9.780 (105)	-	-	-	-	-	-
		D	101.854 (1,096) (Balcony 露台: -(-))(Utility Platform 工作平台: -(-))(Verandah 陽台: -(-))	-	-	-	4.913 (53)	-	-	-	-	-	-
		E	83.053 (894) (Balcony 露台: -(-))(Utility Platform 工作平台: -(-))(Verandah 陽台: -(-))	-	-	-	11.702 (126)	-	-	-	-	-	-
	2/F - 3/F, 5/F & 6/F 2樓-3樓、 5樓及6樓	A	177.161 (1,907) (Balcony 露台: 6.894(74))(Utility Platform 工作平台: 1.583(17))(Verandah 陽台: -(-))	-	-	-	-	-	-	-	-	-	-
		B	170.618 (1,837) (Balcony 露台: 6.834(74))(Utility Platform 工作平台: 2.761(30))(Verandah 陽台: -(-))	-	-	-	-	-	-	-	-	-	-
		C	108.889 (1,172) (Balcony 露台: 3.654(39))(Utility Platform 工作平台: 1.760(19))(Verandah 陽台: -(-))	-	-	-	-	-	-	-	-	-	-
		D	108.930 (1,173) (Balcony 露台: 3.814(41))(Utility Platform 工作平台: 3.262(35))(Verandah 陽台: -(-))	-	-	-	-	-	-	-	-	-	-
		E	89.898 (968) (Balcony 露台: 3.097(33))(Utility Platform 工作平台: 3.748(40))(Verandah 陽台: -(-))	-	-	-	-	-	-	-	-	-	-
	7/F 7樓	A	175.179 (1,886) (Balcony 露台: 6.894(74))(Utility Platform 工作平台: 1.583(17))(Verandah 陽台: -(-))	-	-	-	-	-	-	143.426 (1,544)	-	-	-
		B	170.987 (1,841) (Balcony 露台: 6.834(74))(Utility Platform 工作平台: 2.761(30))(Verandah 陽台: -(-))	-	-	-	-	-	-	121.989 (1,313)	-	-	-
		C	137.712 (1,482) (Balcony 露台: 3.654(39))(Utility Platform 工作平台: -(-))(Verandah 陽台: -(-))	-	-	-	5.241 (56)	-	-	106.005 (1,141)	-	-	-
		D	146.461 (1,577) (Balcony 露台: 3.814(41))(Utility Platform 工作平台: 3.262(35))(Verandah 陽台: -(-))	-	-	-	-	-	-	114.117 (1,228)	-	-	-

- The saleable area of the residential properties is calculated in accordance with Section 8 of the Residential Properties (First-hand Sales) Ordinance.
- The floor area of each of the balcony, utility platform and verandah, if any, to the extent that it forms part of a residential property, is calculated in accordance with Section 8 of the Residential Properties (First-hand Sales) Ordinance.
- The areas of other specified items (not included in the saleable area) are calculated in accordance with Part 2 of Schedule 2 to the Residential Properties (First-hand Sales) Ordinance.

Remarks:

- The areas in square feet have been converted from square metres based on a conversion rate of 1 square metre = 10.764 square feet and rounded off to the nearest integer.
- 4/F is omitted.

- 住宅物業的實用面積是按《一手住宅物業銷售條例》第8條計算得出的。
- 在構成住宅物業的一部分的範圍內的每一露台、工作平台及陽台(如有)之樓面面積是按《一手住宅物業銷售條例》第8條計算得出的。
- 其他指明項目的面積(不計算入實用面積)是按《一手住宅物業銷售條例》附表2第2部計算得出的。

備註:

- 以平方呎列出的面積由以平方米列出的面積以1平方米=10.764平方呎換算,並以四捨五入至整數。
- 不設4樓。

Area of residential properties in the development

發展項目中的住宅物業的面積

Description of Residential Property 物業的描述			Saleable Area (including balcony, utility platform and verandah, if any) sq. metre (sq. ft.) 實用面積 (包括露台、工作平台及陽台(如有))平方米(平方呎)	Area of other specified items (Not included in the Saleable Area) sq. metre (sq. ft.) 其他指明項目的面積(不計算入實用面積) 平方米(平方呎)									
Tower Number 座號	Floor 樓層	Flat 單位		Air-conditioning Plant Room 空調機房	Bay Window 窗台	Cockloft 閣樓	Flat Roof 平台	Garden 花園	Parking Space 停車位	Roof 天台	Stairhood 梯屋	Terrace 前庭	Yard 庭院
Tower 6 座	G/F 地下	A	160.876 (1,732) (Balcony 露台: -)(Utility Platform 工作平台: -)(Verandah 陽台: -)	-	-	-	-	100.764 (1,085)	-	-	-	-	-
		B	160.667 (1,729) (Balcony 露台: -)(Utility Platform 工作平台: -)(Verandah 陽台: -)	-	-	-	-	100.764 (1,085)	-	-	-	-	-
		C	123.882 (1,333) (Balcony 露台: -)(Utility Platform 工作平台: -)(Verandah 陽台: -)	-	-	-	-	52.894 (569)	-	-	-	-	-
		D	158.031 (1,701) (Balcony 露台: -)(Utility Platform 工作平台: -)(Verandah 陽台: -)	-	-	-	-	82.326 (886)	-	-	-	-	-
	1/F 1樓	A	170.617 (1,837) (Balcony 露台: 6.834(74))(Utility Platform 工作平台: 2.761(30))(Verandah 陽台: -)	-	-	-	-	-	-	-	-	-	-
		B	170.617 (1,837) (Balcony 露台: 6.834(74))(Utility Platform 工作平台: 2.761(30))(Verandah 陽台: -)	-	-	-	-	-	-	-	-	-	-
		C	102.867 (1,107) (Balcony 露台: -)(Utility Platform 工作平台: 1.760(19))(Verandah 陽台: -)	-	-	-	6.285 (68)	-	-	-	-	-	-
		D	105.236 (1,133) (Balcony 露台: -)(Utility Platform 工作平台: 1.760(19))(Verandah 陽台: -)	-	-	-	9.780 (105)	-	-	-	-	-	-
		E	83.053 (894) (Balcony 露台: -)(Utility Platform 工作平台: -)(Verandah 陽台: -)	-	-	-	11.816 (127)	-	-	-	-	-	-
	2/F - 3/F, 5/F & 6/F 2樓-3樓、 5樓及6樓	A	170.617 (1,837) (Balcony 露台: 6.834(74))(Utility Platform 工作平台: 2.761(30))(Verandah 陽台: -)	-	-	-	-	-	-	-	-	-	-
		B	170.617 (1,837) (Balcony 露台: 6.834(74))(Utility Platform 工作平台: 2.761(30))(Verandah 陽台: -)	-	-	-	-	-	-	-	-	-	-
		C	106.472 (1,146) (Balcony 露台: 3.606(39))(Utility Platform 工作平台: 1.760(19))(Verandah 陽台: -)	-	-	-	-	-	-	-	-	-	-
		D	108.890 (1,172) (Balcony 露台: 3.654(39))(Utility Platform 工作平台: 1.760(19))(Verandah 陽台: -)	-	-	-	-	-	-	-	-	-	-
		E	89.898 (968) (Balcony 露台: 3.097(33))(Utility Platform 工作平台: 3.748(40))(Verandah 陽台: -)	-	-	-	-	-	-	-	-	-	-
	7/F 7樓	A	170.989 (1,841) (Balcony 露台: 6.834(74))(Utility Platform 工作平台: 2.761(30))(Verandah 陽台: -)	-	-	-	-	-	-	129.951 (1,399)	-	-	-
		B	170.696 (1,837) (Balcony 露台: 6.834(74))(Utility Platform 工作平台: 2.761(30))(Verandah 陽台: -)	-	-	-	-	-	-	152.945 (1,646)	-	-	-
		C	140.260 (1,510) (Balcony 露台: 3.606(39))(Utility Platform 工作平台: -)(Verandah 陽台: -)	-	-	-	-	-	-	104.059 (1,120)	-	-	-
		D	137.713 (1,482) (Balcony 露台: 3.654(39))(Utility Platform 工作平台: -)(Verandah 陽台: -)	-	-	-	5.241 (56)	-	-	106.004 (1,141)	-	-	-

- The saleable area of the residential properties is calculated in accordance with Section 8 of the Residential Properties (First-hand Sales) Ordinance.
- The floor area of each of the balcony, utility platform and verandah, if any, to the extent that it forms part of a residential property, is calculated in accordance with Section 8 of the Residential Properties (First-hand Sales) Ordinance.
- The areas of other specified items (not included in the saleable area) are calculated in accordance with Part 2 of Schedule 2 to the Residential Properties (First-hand Sales) Ordinance.

Remarks:

- The areas in square feet have been converted from square metres based on a conversion rate of 1 square metre = 10.764 square feet and rounded off to the nearest integer.
- 4/F is omitted.

- 住宅物業的實用面積是按《一手住宅物業銷售條例》第8條計算得出的。
- 在構成住宅物業的一部分的範圍內的每一露台、工作平台及陽台(如有)之樓面面積是按《一手住宅物業銷售條例》第8條計算得出的。
- 其他指明項目的面積(不計算入實用面積)是按《一手住宅物業銷售條例》附表2第2部計算得出的。

備註:

- 以平方呎列出的面積由以平方米列出的面積以1平方米=10.764平方呎換算,並以四捨五入至整數。
- 不設4樓。

Area of residential properties in the development

發展項目中的住宅物業的面積

Description of Residential Property 物業的描述			Saleable Area (including balcony, utility platform and verandah, if any) sq. metre (sq. ft.) 實用面積 (包括露台、工作平台及陽台(如有))平方米(平方呎)	Area of other specified items (Not included in the Saleable Area) sq. metre (sq. ft.) 其他指明項目的面積(不計算入實用面積) 平方米(平方呎)									
Tower Number 座號	Floor 樓層	Flat 單位		Air-conditioning Plant Room 空調機房	Bay Window 窗台	Cockloft 閣樓	Flat Roof 平台	Garden 花園	Parking Space 停車位	Roof 天台	Stairhood 梯屋	Terrace 前庭	Yard 庭院
Tower 7 座	G/F 地下	A	160.876 (1,732) (Balcony 露台: -(-))(Utility Platform 工作平台: -(-))(Verandah 陽台: -(-))	-	-	-	-	100.764 (1,085)	-	-	-	-	-
		B	160.667 (1,729) (Balcony 露台: -(-))(Utility Platform 工作平台: -(-))(Verandah 陽台: -(-))	-	-	-	-	100.764 (1,085)	-	-	-	-	-
		C	123.882 (1,333) (Balcony 露台: -(-))(Utility Platform 工作平台: -(-))(Verandah 陽台: -(-))	-	-	-	-	30.520 (329)	-	-	-	-	-
		D	158.031 (1,701) (Balcony 露台: -(-))(Utility Platform 工作平台: -(-))(Verandah 陽台: -(-))	-	-	-	-	45.675 (492)	-	-	-	-	-
	1/F 1樓	A	170.617 (1,837) (Balcony 露台: 6.834(74))(Utility Platform 工作平台: 2.761(30))(Verandah 陽台: -(-))	-	-	-	-	-	-	-	-	-	-
		B	170.617 (1,837) (Balcony 露台: 6.834(74))(Utility Platform 工作平台: 2.761(30))(Verandah 陽台: -(-))	-	-	-	-	-	-	-	-	-	-
		C	102.867 (1,107) (Balcony 露台: -(-))(Utility Platform 工作平台: 1.760(19))(Verandah 陽台: -(-))	-	-	-	6.285 (68)	-	-	-	-	-	-
		D	105.236 (1,133) (Balcony 露台: -(-))(Utility Platform 工作平台: 1.760(19))(Verandah 陽台: -(-))	-	-	-	9.780 (105)	-	-	-	-	-	-
		E	83.053 (894) (Balcony 露台: -(-))(Utility Platform 工作平台: -(-))(Verandah 陽台: -(-))	-	-	-	11.816 (127)	-	-	-	-	-	-
	2/F - 3/F, 5/F & 6/F 2樓-3樓、 5樓及6樓	A	170.617 (1,837) (Balcony 露台: 6.834(74))(Utility Platform 工作平台: 2.761(30))(Verandah 陽台: -(-))	-	-	-	-	-	-	-	-	-	-
		B	170.617 (1,837) (Balcony 露台: 6.834(74))(Utility Platform 工作平台: 2.761(30))(Verandah 陽台: -(-))	-	-	-	-	-	-	-	-	-	-
		C	106.472 (1,146) (Balcony 露台: 3.606(39))(Utility Platform 工作平台: 1.760(19))(Verandah 陽台: -(-))	-	-	-	-	-	-	-	-	-	-
		D	108.890 (1,172) (Balcony 露台: 3.654(39))(Utility Platform 工作平台: 1.760(19))(Verandah 陽台: -(-))	-	-	-	-	-	-	-	-	-	-
		E	89.898 (968) (Balcony 露台: 3.097(33))(Utility Platform 工作平台: 3.748(40))(Verandah 陽台: -(-))	-	-	-	-	-	-	-	-	-	-
	7/F 7樓	A	170.989 (1,841) (Balcony 露台: 6.834(74))(Utility Platform 工作平台: 2.761(30))(Verandah 陽台: -(-))	-	-	-	-	-	-	129.952 (1,399)	-	-	-
		B	170.696 (1,837) (Balcony 露台: 6.834(74))(Utility Platform 工作平台: 2.761(30))(Verandah 陽台: -(-))	-	-	-	-	-	-	152.945 (1,646)	-	-	-
		C	140.260 (1,510) (Balcony 露台: 3.606(39))(Utility Platform 工作平台: -(-))(Verandah 陽台: -(-))	-	-	-	-	-	-	104.059 (1,120)	-	-	-
		D	137.713 (1,482) (Balcony 露台: 3.654(39))(Utility Platform 工作平台: -(-))(Verandah 陽台: -(-))	-	-	-	5.241 (56)	-	-	106.004 (1,141)	-	-	-

- The saleable area of the residential properties is calculated in accordance with Section 8 of the Residential Properties (First-hand Sales) Ordinance.
- The floor area of each of the balcony, utility platform and verandah, if any, to the extent that it forms part of a residential property, is calculated in accordance with Section 8 of the Residential Properties (First-hand Sales) Ordinance.
- The areas of other specified items (not included in the saleable area) are calculated in accordance with Part 2 of Schedule 2 to the Residential Properties (First-hand Sales) Ordinance.

Remarks:

- The areas in square feet have been converted from square metres based on a conversion rate of 1 square metre = 10.764 square feet and rounded off to the nearest integer.
- 4/F is omitted.

- 住宅物業的實用面積是按《一手住宅物業銷售條例》第8條計算得出的。
- 在構成住宅物業的一部分的範圍內的每一露台、工作平台及陽台(如有)之樓面面積是按《一手住宅物業銷售條例》第8條計算得出的。
- 其他指明項目的面積(不計算入實用面積)是按《一手住宅物業銷售條例》附表2第2部計算得出的。

備註:

- 以平方呎列出的面積由以平方米列出的面積以1平方米=10.764平方呎換算,並以四捨五入至整數。
- 不設4樓。

Area of residential properties in the development

發展項目中的住宅物業的面積

Description of Residential Property 物業的描述			Saleable Area (including balcony, utility platform and verandah, if any) sq. metre (sq. ft.) 實用面積 (包括露台、工作平台及陽台(如有))平方米(平方呎)	Area of other specified items (Not included in the Saleable Area) sq. metre (sq. ft.) 其他指明項目的面積(不計算入實用面積) 平方米(平方呎)									
Tower Number 座號	Floor 樓層	Flat 單位		Air-conditioning Plant Room 空調機房	Bay Window 窗台	Cockloft 閣樓	Flat Roof 平台	Garden 花園	Parking Space 停車位	Roof 天台	Stairhood 梯屋	Terrace 前庭	Yard 庭院
Tower 8 座	G/F 地下	A	160.876 (1,732) (Balcony 露台: -)(Utility Platform 工作平台: -)(Verandah 陽台: -)	-	-	-	-	100.764 (1,085)	-	-	-	-	-
		B	160.667 (1,729) (Balcony 露台: -)(Utility Platform 工作平台: -)(Verandah 陽台: -)	-	-	-	-	100.764 (1,085)	-	-	-	-	-
		C	124.000 (1,335) (Balcony 露台: -)(Utility Platform 工作平台: -)(Verandah 陽台: -)	-	-	-	-	28.390 (306)	-	-	-	-	-
		D	158.031 (1,701) (Balcony 露台: -)(Utility Platform 工作平台: -)(Verandah 陽台: -)	-	-	-	-	28.770 (310)	-	-	-	-	-
	1/F 1樓	A	170.617 (1,837) (Balcony 露台: 6.834(74))(Utility Platform 工作平台: 2.761(30))(Verandah 陽台: -)	-	-	-	-	-	-	-	-	-	-
		B	170.617 (1,837) (Balcony 露台: 6.834(74))(Utility Platform 工作平台: 2.761(30))(Verandah 陽台: -)	-	-	-	-	-	-	-	-	-	-
		C	102.984 (1,109) (Balcony 露台: -)(Utility Platform 工作平台: 1.760(19))(Verandah 陽台: -)	-	-	-	6.285 (68)	-	-	-	-	-	-
		D	105.236 (1,133) (Balcony 露台: -)(Utility Platform 工作平台: 1.760(19))(Verandah 陽台: -)	-	-	-	9.780 (105)	-	-	-	-	-	-
		E	83.053 (894) (Balcony 露台: -)(Utility Platform 工作平台: -)(Verandah 陽台: -)	-	-	-	11.816 (127)	-	-	-	-	-	-
	2/F - 3/F, 5/F & 6/F 2樓-3樓、 5樓及6樓	A	170.617 (1,837) (Balcony 露台: 6.834(74))(Utility Platform 工作平台: 2.761(30))(Verandah 陽台: -)	-	-	-	-	-	-	-	-	-	-
		B	170.617 (1,837) (Balcony 露台: 6.834(74))(Utility Platform 工作平台: 2.761(30))(Verandah 陽台: -)	-	-	-	-	-	-	-	-	-	-
		C	106.590 (1,147) (Balcony 露台: 3.606(39))(Utility Platform 工作平台: 1.760(19))(Verandah 陽台: -)	-	-	-	-	-	-	-	-	-	-
		D	108.890 (1,172) (Balcony 露台: 3.654(39))(Utility Platform 工作平台: 1.760(19))(Verandah 陽台: -)	-	-	-	-	-	-	-	-	-	-
		E	89.898 (968) (Balcony 露台: 3.097(33))(Utility Platform 工作平台: 3.748(40))(Verandah 陽台: -)	-	-	-	-	-	-	-	-	-	-
	7/F 7樓	A	170.989 (1,841) (Balcony 露台: 6.834(74))(Utility Platform 工作平台: 2.761(30))(Verandah 陽台: -)	-	-	-	-	-	-	129.951 (1,399)	-	-	-
		B	170.696 (1,837) (Balcony 露台: 6.834(74))(Utility Platform 工作平台: 2.761(30))(Verandah 陽台: -)	-	-	-	-	-	-	152.945 (1,646)	-	-	-
		C	140.378 (1,511) (Balcony 露台: 3.606(39))(Utility Platform 工作平台: -)(Verandah 陽台: -)	-	-	-	-	-	-	104.283 (1,123)	-	-	-
		D	137.713 (1,482) (Balcony 露台: 3.654(39))(Utility Platform 工作平台: -)(Verandah 陽台: -)	-	-	-	5.241 (56)	-	-	106.004 (1,141)	-	-	-

- The saleable area of the residential properties is calculated in accordance with Section 8 of the Residential Properties (First-hand Sales) Ordinance.
- The floor area of each of the balcony, utility platform and verandah, if any, to the extent that it forms part of a residential property, is calculated in accordance with Section 8 of the Residential Properties (First-hand Sales) Ordinance.
- The areas of other specified items (not included in the saleable area) are calculated in accordance with Part 2 of Schedule 2 to the Residential Properties (First-hand Sales) Ordinance.

Remarks:

- The areas in square feet have been converted from square metres based on a conversion rate of 1 square metre = 10.764 square feet and rounded off to the nearest integer.
- 4/F is omitted.

- 住宅物業的實用面積是按《一手住宅物業銷售條例》第8條計算得出的。
- 在構成住宅物業的一部分的範圍內的每一露台、工作平台及陽台(如有)之樓面面積是按《一手住宅物業銷售條例》第8條計算得出的。
- 其他指明項目的面積(不計算入實用面積)是按《一手住宅物業銷售條例》附表2第2部計算得出的。

備註:

- 以平方呎列出的面積由以平方米列出的面積以1平方米=10.764平方呎換算,並以四捨五入至整數。
- 不設4樓。

Area of residential properties in the development

發展項目中的住宅物業的面積

Description of Residential Property 物業的描述			Saleable Area (including balcony, utility platform and verandah, if any) sq. metre (sq. ft.) 實用面積 (包括露台、工作平台及陽台(如有))平方米(平方呎)	Area of other specified items (Not included in the Saleable Area) sq. metre (sq. ft.) 其他指明項目的面積(不計算入實用面積) 平方米(平方呎)									
Tower Number 座號	Floor 樓層	Flat 單位		Air-conditioning Plant Room 空調機房	Bay Window 窗台	Cockloft 閣樓	Flat Roof 平台	Garden 花園	Parking Space 停車位	Roof 天台	Stairhood 梯屋	Terrace 前庭	Yard 庭院
Tower 9 座	G/F 地下	A	160.919 (1,732) (Balcony 露台: -(-))(Utility Platform 工作平台: -(-))(Verandah 陽台: -(-))	-	-	-	-	100.728 (1,084)	-	-	-	-	-
		B	160.710 (1,730) (Balcony 露台: -(-))(Utility Platform 工作平台: -(-))(Verandah 陽台: -(-))	-	-	-	-	100.728 (1,084)	-	-	-	-	-
		C	124.917 (1,345) (Balcony 露台: -(-))(Utility Platform 工作平台: -(-))(Verandah 陽台: -(-))	-	-	-	-	39.981 (430)	-	-	-	-	-
		D	157.924 (1,700) (Balcony 露台: -(-))(Utility Platform 工作平台: -(-))(Verandah 陽台: -(-))	-	-	-	-	39.410 (424)	-	-	-	-	-
	1/F 1樓	A	170.616 (1,837) (Balcony 露台: 6.834(74))(Utility Platform 工作平台: 2.719(29))(Verandah 陽台: -(-))	-	-	-	-	-	-	-	-	-	-
		B	170.616 (1,837) (Balcony 露台: 6.834(74))(Utility Platform 工作平台: 2.719(29))(Verandah 陽台: -(-))	-	-	-	-	-	-	-	-	-	-
		C	103.900 (1,118) (Balcony 露台: -(-))(Utility Platform 工作平台: 1.760(19))(Verandah 陽台: -(-))	-	-	-	6.285 (68)	-	-	-	-	-	-
		D	105.353 (1,134) (Balcony 露台: -(-))(Utility Platform 工作平台: 1.760(19))(Verandah 陽台: -(-))	-	-	-	9.780 (105)	-	-	-	-	-	-
		E	83.053 (894) (Balcony 露台: -(-))(Utility Platform 工作平台: -(-))(Verandah 陽台: -(-))	-	-	-	11.816 (127)	-	-	-	-	-	-
	2/F - 3/F, 5/F & 6/F 2樓-3樓、 5樓及6樓	A	170.616 (1,837) (Balcony 露台: 6.834(74))(Utility Platform 工作平台: 2.719(29))(Verandah 陽台: -(-))	-	-	-	-	-	-	-	-	-	-
		B	170.616 (1,837) (Balcony 露台: 6.834(74))(Utility Platform 工作平台: 2.719(29))(Verandah 陽台: -(-))	-	-	-	-	-	-	-	-	-	-
		C	107.506 (1,157) (Balcony 露台: 3.606(39))(Utility Platform 工作平台: 1.760(19))(Verandah 陽台: -(-))	-	-	-	-	-	-	-	-	-	-
		D	109.007 (1,173) (Balcony 露台: 3.654(39))(Utility Platform 工作平台: 1.760(19))(Verandah 陽台: -(-))	-	-	-	-	-	-	-	-	-	-
		E	89.898 (968) (Balcony 露台: 3.097(33))(Utility Platform 工作平台: 3.748(40))(Verandah 陽台: -(-))	-	-	-	-	-	-	-	-	-	-
	7/F 7樓	A	170.988 (1,841) (Balcony 露台: 6.834(74))(Utility Platform 工作平台: 2.719(29))(Verandah 陽台: -(-))	-	-	-	-	-	-	129.951 (1,399)	-	-	-
		B	170.695 (1,837) (Balcony 露台: 6.834(74))(Utility Platform 工作平台: 2.719(29))(Verandah 陽台: -(-))	-	-	-	-	-	-	152.945 (1,646)	-	-	-
		C	141.295 (1,521) (Balcony 露台: 3.606(39))(Utility Platform 工作平台: -(-))(Verandah 陽台: -(-))	-	-	-	-	-	-	105.405 (1,135)	-	-	-
		D	137.830 (1,484) (Balcony 露台: 3.654(39))(Utility Platform 工作平台: -(-))(Verandah 陽台: -(-))	-	-	-	5.241 (56)	-	-	106.228 (1,143)	-	-	-

- The saleable area of the residential properties is calculated in accordance with Section 8 of the Residential Properties (First-hand Sales) Ordinance.
- The floor area of each of the balcony, utility platform and verandah, if any, to the extent that it forms part of a residential property, is calculated in accordance with Section 8 of the Residential Properties (First-hand Sales) Ordinance.
- The areas of other specified items (not included in the saleable area) are calculated in accordance with Part 2 of Schedule 2 to the Residential Properties (First-hand Sales) Ordinance.

Remarks:

- The areas in square feet have been converted from square metres based on a conversion rate of 1 square metre = 10.764 square feet and rounded off to the nearest integer.
- 4/F is omitted.

- 住宅物業的實用面積是按《一手住宅物業銷售條例》第8條計算得出的。
- 在構成住宅物業的一部分的範圍內的每一露台、工作平台及陽台(如有)之樓面面積是按《一手住宅物業銷售條例》第8條計算得出的。
- 其他指明項目的面積(不計算入實用面積)是按《一手住宅物業銷售條例》附表2第2部計算得出的。

備註:

- 以平方呎列出的面積由以平方米列出的面積以1平方米=10.764平方呎換算,並以四捨五入至整數。
- 不設4樓。

Area of residential properties in the development

發展項目中的住宅物業的面積

Description of Residential Property 物業的描述			Saleable Area (including balcony, utility platform and verandah, if any) sq. metre (sq. ft.) 實用面積 (包括露台、工作平台及陽台(如有))平方米(平方呎)	Area of other specified items (Not included in the Saleable Area) sq. metre (sq. ft.) 其他指明項目的面積(不計算入實用面積) 平方米(平方呎)									
Tower Number 座號	Floor 樓層	Flat 單位		Air-conditioning Plant Room 空調機房	Bay Window 窗台	Cockloft 閣樓	Flat Roof 平台	Garden 花園	Parking Space 停車位	Roof 天台	Stairhood 梯屋	Terrace 前庭	Yard 庭院
Tower 10 座	G/F 地下	A	160.918 (1,732) (Balcony 露台: -(-))(Utility Platform 工作平台: -(-))(Verandah 陽台: -(-))	-	-	-	-	100.728 (1,084)	-	-	-	-	-
		B	160.709 (1,730) (Balcony 露台: -(-))(Utility Platform 工作平台: -(-))(Verandah 陽台: -(-))	-	-	-	-	100.728 (1,084)	-	-	-	-	-
		C	124.917 (1,345) (Balcony 露台: -(-))(Utility Platform 工作平台: -(-))(Verandah 陽台: -(-))	-	-	-	-	33.315 (359)	-	-	-	-	-
		D	158.840 (1,710) (Balcony 露台: -(-))(Utility Platform 工作平台: -(-))(Verandah 陽台: -(-))	-	-	-	-	45.373 (488)	-	-	-	-	-
	1/F 1樓	A	170.616 (1,837) (Balcony 露台: 6.834(74))(Utility Platform 工作平台: 2.719(29))(Verandah 陽台: -(-))	-	-	-	-	-	-	-	-	-	-
		B	170.616 (1,837) (Balcony 露台: 6.834(74))(Utility Platform 工作平台: 2.719(29))(Verandah 陽台: -(-))	-	-	-	-	-	-	-	-	-	-
		C	103.900 (1,118) (Balcony 露台: -(-))(Utility Platform 工作平台: 1.760(19))(Verandah 陽台: -(-))	-	-	-	6.285 (68)	-	-	-	-	-	-
		D	106.269 (1,144) (Balcony 露台: -(-))(Utility Platform 工作平台: 1.760(19))(Verandah 陽台: -(-))	-	-	-	9.780 (105)	-	-	-	-	-	-
		E	83.053 (894) (Balcony 露台: -(-))(Utility Platform 工作平台: -(-))(Verandah 陽台: -(-))	-	-	-	11.816 (127)	-	-	-	-	-	-
	2/F - 3/F, 5/F & 6/F 2樓-3樓、 5樓及6樓	A	170.616 (1,837) (Balcony 露台: 6.834(74))(Utility Platform 工作平台: 2.719(29))(Verandah 陽台: -(-))	-	-	-	-	-	-	-	-	-	-
		B	170.616 (1,837) (Balcony 露台: 6.834(74))(Utility Platform 工作平台: 2.719(29))(Verandah 陽台: -(-))	-	-	-	-	-	-	-	-	-	-
		C	107.506 (1,157) (Balcony 露台: 3.606(39))(Utility Platform 工作平台: 1.760(19))(Verandah 陽台: -(-))	-	-	-	-	-	-	-	-	-	-
		D	109.923 (1,183) (Balcony 露台: 3.654(39))(Utility Platform 工作平台: 1.760(19))(Verandah 陽台: -(-))	-	-	-	-	-	-	-	-	-	-
		E	89.898 (968) (Balcony 露台: 3.097(33))(Utility Platform 工作平台: 3.748(40))(Verandah 陽台: -(-))	-	-	-	-	-	-	-	-	-	-
	7/F 7樓	A	170.988 (1,841) (Balcony 露台: 6.834(74))(Utility Platform 工作平台: 2.719(29))(Verandah 陽台: -(-))	-	-	-	-	-	-	129.951 (1,399)	-	-	-
		B	170.695 (1,837) (Balcony 露台: 6.834(74))(Utility Platform 工作平台: 2.719(29))(Verandah 陽台: -(-))	-	-	-	-	-	-	152.945 (1,646)	-	-	-
		C	141.295 (1,521) (Balcony 露台: 3.606(39))(Utility Platform 工作平台: -(-))(Verandah 陽台: -(-))	-	-	-	-	-	-	105.500 (1,136)	-	-	-
		D	138.746 (1,493) (Balcony 露台: 3.654(39))(Utility Platform 工作平台: -(-))(Verandah 陽台: -(-))	-	-	-	5.241 (56)	-	-	107.454 (1,157)	-	-	-

- The saleable area of the residential properties is calculated in accordance with Section 8 of the Residential Properties (First-hand Sales) Ordinance.
- The floor area of each of the balcony, utility platform and verandah, if any, to the extent that it forms part of a residential property, is calculated in accordance with Section 8 of the Residential Properties (First-hand Sales) Ordinance.
- The areas of other specified items (not included in the saleable area) are calculated in accordance with Part 2 of Schedule 2 to the Residential Properties (First-hand Sales) Ordinance.

Remarks:

- The areas in square feet have been converted from square metres based on a conversion rate of 1 square metre = 10.764 square feet and rounded off to the nearest integer.
- 4/F is omitted.

- 住宅物業的實用面積是按《一手住宅物業銷售條例》第8條計算得出的。
- 在構成住宅物業的一部分的範圍內的每一露台、工作平台及陽台(如有)之樓面面積是按《一手住宅物業銷售條例》第8條計算得出的。
- 其他指明項目的面積(不計算入實用面積)是按《一手住宅物業銷售條例》附表2第2部計算得出的。

備註:

- 以平方呎列出的面積由以平方米列出的面積以1平方米=10.764平方呎換算,並以四捨五入至整數。
- 不設4樓。

Area of residential properties in the development

發展項目中的住宅物業的面積

Description of Residential Property 物業的描述			Saleable Area (including balcony, utility platform and verandah, if any) sq. metre (sq. ft.) 實用面積 (包括露台、工作平台及陽台(如有))平方米(平方呎)	Area of other specified items (Not included in the Saleable Area) sq. metre (sq. ft.) 其他指明項目的面積(不計算入實用面積) 平方米(平方呎)									
Tower Number 座號	Floor 樓層	Flat 單位		Air-conditioning Plant Room 空調機房	Bay Window 窗台	Cockloft 閣樓	Flat Roof 平台	Garden 花園	Parking Space 停車位	Roof 天台	Stairhood 梯屋	Terrace 前庭	Yard 庭院
Tower 11 座	G/F 地下	A	160.918 (1,732) (Balcony 露台: -(-))(Utility Platform 工作平台: -(-))(Verandah 陽台: -(-))	-	-	-	-	100.728 (1,084)	-	-	-	-	-
		B	160.709 (1,730) (Balcony 露台: -(-))(Utility Platform 工作平台: -(-))(Verandah 陽台: -(-))	-	-	-	-	100.728 (1,084)	-	-	-	-	-
		C	124.953 (1,345) (Balcony 露台: -(-))(Utility Platform 工作平台: -(-))(Verandah 陽台: -(-))	-	-	-	-	32.724 (352)	-	-	-	-	-
		D	158.840 (1,710) (Balcony 露台: -(-))(Utility Platform 工作平台: -(-))(Verandah 陽台: -(-))	-	-	-	-	33.563 (361)	-	-	-	-	-
	1/F 1樓	A	170.616 (1,837) (Balcony 露台: 6.834(74))(Utility Platform 工作平台: 2.719(29))(Verandah 陽台: -(-))	-	-	-	-	-	-	-	-	-	-
		B	170.616 (1,837) (Balcony 露台: 6.834(74))(Utility Platform 工作平台: 2.719(29))(Verandah 陽台: -(-))	-	-	-	-	-	-	-	-	-	-
		C	103.936 (1,119) (Balcony 露台: -(-))(Utility Platform 工作平台: 1.760(19))(Verandah 陽台: -(-))	-	-	-	6.285 (68)	-	-	-	-	-	-
		D	106.269 (1,144) (Balcony 露台: -(-))(Utility Platform 工作平台: 1.760(19))(Verandah 陽台: -(-))	-	-	-	9.780 (105)	-	-	-	-	-	-
		E	83.053 (894) (Balcony 露台: -(-))(Utility Platform 工作平台: -(-))(Verandah 陽台: -(-))	-	-	-	11.816 (127)	-	-	-	-	-	-
	2/F - 3/F, 5/F & 6/F 2樓-3樓、 5樓及6樓	A	170.616 (1,837) (Balcony 露台: 6.834(74))(Utility Platform 工作平台: 2.719(29))(Verandah 陽台: -(-))	-	-	-	-	-	-	-	-	-	-
		B	170.616 (1,837) (Balcony 露台: 6.834(74))(Utility Platform 工作平台: 2.719(29))(Verandah 陽台: -(-))	-	-	-	-	-	-	-	-	-	-
		C	107.542 (1,158) (Balcony 露台: 3.606(39))(Utility Platform 工作平台: 1.760(19))(Verandah 陽台: -(-))	-	-	-	-	-	-	-	-	-	-
		D	109.923 (1,183) (Balcony 露台: 3.654(39))(Utility Platform 工作平台: 1.760(19))(Verandah 陽台: -(-))	-	-	-	-	-	-	-	-	-	-
		E	89.898 (968) (Balcony 露台: 3.097(33))(Utility Platform 工作平台: 3.748(40))(Verandah 陽台: -(-))	-	-	-	-	-	-	-	-	-	-
	7/F 7樓	A	170.988 (1,841) (Balcony 露台: 6.834(74))(Utility Platform 工作平台: 2.719(29))(Verandah 陽台: -(-))	-	-	-	-	-	-	129.951 (1,399)	-	-	-
		B	170.695 (1,837) (Balcony 露台: 6.834(74))(Utility Platform 工作平台: 2.719(29))(Verandah 陽台: -(-))	-	-	-	-	-	-	152.945 (1,646)	-	-	-
		C	141.331 (1,521) (Balcony 露台: 3.606(39))(Utility Platform 工作平台: -(-))(Verandah 陽台: -(-))	-	-	-	-	-	-	105.455 (1,135)	-	-	-
		D	138.746 (1,493) (Balcony 露台: 3.654(39))(Utility Platform 工作平台: -(-))(Verandah 陽台: -(-))	-	-	-	5.241 (56)	-	-	107.445 (1,157)	-	-	-

- The saleable area of the residential properties is calculated in accordance with Section 8 of the Residential Properties (First-hand Sales) Ordinance.
- The floor area of each of the balcony, utility platform and verandah, if any, to the extent that it forms part of a residential property, is calculated in accordance with Section 8 of the Residential Properties (First-hand Sales) Ordinance.
- The areas of other specified items (not included in the saleable area) are calculated in accordance with Part 2 of Schedule 2 to the Residential Properties (First-hand Sales) Ordinance.

Remarks:

- The areas in square feet have been converted from square metres based on a conversion rate of 1 square metre = 10.764 square feet and rounded off to the nearest integer.
- 4/F is omitted.

- 住宅物業的實用面積是按《一手住宅物業銷售條例》第8條計算得出的。
- 在構成住宅物業的一部分的範圍內的每一露台、工作平台及陽台(如有)之樓面面積是按《一手住宅物業銷售條例》第8條計算得出的。
- 其他指明項目的面積(不計算入實用面積)是按《一手住宅物業銷售條例》附表2第2部計算得出的。

備註:

- 以平方呎列出的面積由以平方米列出的面積以1平方米=10.764平方呎換算,並以四捨五入至整數。
- 不設4樓。

Area of residential properties in the development

發展項目中的住宅物業的面積

Description of Residential Property 物業的描述			Saleable Area (including balcony, utility platform and verandah, if any) sq. metre (sq. ft.) 實用面積 (包括露台、工作平台及陽台(如有))平方米(平方呎)	Area of other specified items (Not included in the Saleable Area) sq. metre (sq. ft.) 其他指明項目的面積(不計算入實用面積) 平方米(平方呎)									
Tower Number 座號	Floor 樓層	Flat 單位		Air-conditioning Plant Room 空調機房	Bay Window 窗台	Cockloft 閣樓	Flat Roof 平台	Garden 花園	Parking Space 停車位	Roof 天台	Stairhood 梯屋	Terrace 前庭	Yard 庭院
Tower 12 座	G/F 地下	A	160.918 (1,732) (Balcony 露台: -(-))(Utility Platform 工作平台: -(-))(Verandah 陽台: -(-))	-	-	-	-	100.728 (1,084)	-	-	-	-	-
		B	160.709 (1,730) (Balcony 露台: -(-))(Utility Platform 工作平台: -(-))(Verandah 陽台: -(-))	-	-	-	-	100.728 (1,084)	-	-	-	-	-
		C	124.917 (1,345) (Balcony 露台: -(-))(Utility Platform 工作平台: -(-))(Verandah 陽台: -(-))	-	-	-	-	24.748 (266)	-	-	-	-	-
		D	158.876 (1,710) (Balcony 露台: -(-))(Utility Platform 工作平台: -(-))(Verandah 陽台: -(-))	-	-	-	-	30.499 (328)	-	-	-	-	-
	1/F 1樓	A	170.616 (1,837) (Balcony 露台: 6.834(74))(Utility Platform 工作平台: 2.719(29))(Verandah 陽台: -(-))	-	-	-	-	-	-	-	-	-	-
		B	170.616 (1,837) (Balcony 露台: 6.834(74))(Utility Platform 工作平台: 2.719(29))(Verandah 陽台: -(-))	-	-	-	-	-	-	-	-	-	-
		C	103.900 (1,118) (Balcony 露台: -(-))(Utility Platform 工作平台: 1.760(19))(Verandah 陽台: -(-))	-	-	-	6.285 (68)	-	-	-	-	-	-
		D	106.305 (1,144) (Balcony 露台: -(-))(Utility Platform 工作平台: 1.760(19))(Verandah 陽台: -(-))	-	-	-	9.780 (105)	-	-	-	-	-	-
		E	83.053 (894) (Balcony 露台: -(-))(Utility Platform 工作平台: -(-))(Verandah 陽台: -(-))	-	-	-	11.816 (127)	-	-	-	-	-	-
	2/F - 3/F, 5/F & 6/F 2樓-3樓、 5樓及6樓	A	170.616 (1,837) (Balcony 露台: 6.834(74))(Utility Platform 工作平台: 2.719(29))(Verandah 陽台: -(-))	-	-	-	-	-	-	-	-	-	-
		B	170.616 (1,837) (Balcony 露台: 6.834(74))(Utility Platform 工作平台: 2.719(29))(Verandah 陽台: -(-))	-	-	-	-	-	-	-	-	-	-
		C	107.506 (1,157) (Balcony 露台: 3.606(39))(Utility Platform 工作平台: 1.760(19))(Verandah 陽台: -(-))	-	-	-	-	-	-	-	-	-	-
		D	109.959 (1,184) (Balcony 露台: 3.654(39))(Utility Platform 工作平台: 1.760(19))(Verandah 陽台: -(-))	-	-	-	-	-	-	-	-	-	-
		E	89.898 (968) (Balcony 露台: 3.097(33))(Utility Platform 工作平台: 3.748(40))(Verandah 陽台: -(-))	-	-	-	-	-	-	-	-	-	-
	7/F 7樓	A	170.988 (1,841) (Balcony 露台: 6.834(74))(Utility Platform 工作平台: 2.719(29))(Verandah 陽台: -(-))	-	-	-	-	-	-	129.951 (1,399)	-	-	-
		B	170.695 (1,837) (Balcony 露台: 6.834(74))(Utility Platform 工作平台: 2.719(29))(Verandah 陽台: -(-))	-	-	-	-	-	-	152.945 (1,646)	-	-	-
		C	141.295 (1,521) (Balcony 露台: 3.606(39))(Utility Platform 工作平台: -(-))(Verandah 陽台: -(-))	-	-	-	-	-	-	105.455 (1,135)	-	-	-
		D	138.782 (1,494) (Balcony 露台: 3.654(39))(Utility Platform 工作平台: -(-))(Verandah 陽台: -(-))	-	-	-	5.241 (56)	-	-	107.445 (1,157)	-	-	-

- The saleable area of the residential properties is calculated in accordance with Section 8 of the Residential Properties (First-hand Sales) Ordinance.
- The floor area of each of the balcony, utility platform and verandah, if any, to the extent that it forms part of a residential property, is calculated in accordance with Section 8 of the Residential Properties (First-hand Sales) Ordinance.
- The areas of other specified items (not included in the saleable area) are calculated in accordance with Part 2 of Schedule 2 to the Residential Properties (First-hand Sales) Ordinance.

Remarks:

- The areas in square feet have been converted from square metres based on a conversion rate of 1 square metre = 10.764 square feet and rounded off to the nearest integer.
- 4/F is omitted.

- 住宅物業的實用面積是按《一手住宅物業銷售條例》第8條計算得出的。
- 在構成住宅物業的一部分的範圍內的每一露台、工作平台及陽台(如有)之樓面面積是按《一手住宅物業銷售條例》第8條計算得出的。
- 其他指明項目的面積(不計算入實用面積)是按《一手住宅物業銷售條例》附表2第2部計算得出的。

備註:

- 以平方呎列出的面積由以平方米列出的面積以1平方米=10.764平方呎換算,並以四捨五入至整數。
- 不設4樓。

Area of residential properties in the development

發展項目中的住宅物業的面積

Description of Residential Property 物業的描述			Saleable Area (including balcony, utility platform and verandah, if any) sq. metre (sq. ft.) 實用面積 (包括露台、工作平台及陽台(如有))平方米(平方呎)	Area of other specified items (Not included in the Saleable Area) sq. metre (sq. ft.) 其他指明項目的面積(不計算入實用面積) 平方米(平方呎)									
Tower Number 座號	Floor 樓層	Flat 單位		Air-conditioning Plant Room 空調機房	Bay Window 窗台	Cockloft 閣樓	Flat Roof 平台	Garden 花園	Parking Space 停車位	Roof 天台	Stairhood 梯屋	Terrace 前庭	Yard 庭院
Tower 15 座	G/F 地下	A	160.918 (1,732) (Balcony 露台: -(-))(Utility Platform 工作平台: -(-))(Verandah 陽台: -(-))	-	-	-	-	100.728 (1,084)	-	-	-	-	-
		B	160.709 (1,730) (Balcony 露台: -(-))(Utility Platform 工作平台: -(-))(Verandah 陽台: -(-))	-	-	-	-	100.728 (1,084)	-	-	-	-	-
		C	124.917 (1,345) (Balcony 露台: -(-))(Utility Platform 工作平台: -(-))(Verandah 陽台: -(-))	-	-	-	-	27.460 (296)	-	-	-	-	-
		D	158.840 (1,710) (Balcony 露台: -(-))(Utility Platform 工作平台: -(-))(Verandah 陽台: -(-))	-	-	-	-	24.535 (264)	-	-	-	-	-
	1/F 1樓	A	170.616 (1,837) (Balcony 露台: 6.834(74))(Utility Platform 工作平台: 2.719(29))(Verandah 陽台: -(-))	-	-	-	-	-	-	-	-	-	-
		B	170.616 (1,837) (Balcony 露台: 6.834(74))(Utility Platform 工作平台: 2.719(29))(Verandah 陽台: -(-))	-	-	-	-	-	-	-	-	-	-
		C	103.900 (1,118) (Balcony 露台: -(-))(Utility Platform 工作平台: 1.760(19))(Verandah 陽台: -(-))	-	-	-	6.285 (68)	-	-	-	-	-	-
		D	106.269 (1,144) (Balcony 露台: -(-))(Utility Platform 工作平台: 1.760(19))(Verandah 陽台: -(-))	-	-	-	9.780 (105)	-	-	-	-	-	-
		E	83.053 (894) (Balcony 露台: -(-))(Utility Platform 工作平台: -(-))(Verandah 陽台: -(-))	-	-	-	11.816 (127)	-	-	-	-	-	-
	2/F - 3/F, 5/F & 6/F 2樓-3樓、 5樓及6樓	A	170.616 (1,837) (Balcony 露台: 6.834(74))(Utility Platform 工作平台: 2.719(29))(Verandah 陽台: -(-))	-	-	-	-	-	-	-	-	-	-
		B	170.616 (1,837) (Balcony 露台: 6.834(74))(Utility Platform 工作平台: 2.719(29))(Verandah 陽台: -(-))	-	-	-	-	-	-	-	-	-	-
		C	107.506 (1,157) (Balcony 露台: 3.606(39))(Utility Platform 工作平台: 1.760(19))(Verandah 陽台: -(-))	-	-	-	-	-	-	-	-	-	-
		D	109.923 (1,183) (Balcony 露台: 3.654(39))(Utility Platform 工作平台: 1.760(19))(Verandah 陽台: -(-))	-	-	-	-	-	-	-	-	-	-
		E	89.898 (968) (Balcony 露台: 3.097(33))(Utility Platform 工作平台: 3.748(40))(Verandah 陽台: -(-))	-	-	-	-	-	-	-	-	-	-
	7/F 7樓	A	170.988 (1,841) (Balcony 露台: 6.834(74))(Utility Platform 工作平台: 2.719(29))(Verandah 陽台: -(-))	-	-	-	-	-	-	129.950 (1,399)	-	-	-
		B	170.695 (1,837) (Balcony 露台: 6.834(74))(Utility Platform 工作平台: 2.719(29))(Verandah 陽台: -(-))	-	-	-	-	-	-	152.945 (1,646)	-	-	-
		C	141.295 (1,521) (Balcony 露台: 3.606(39))(Utility Platform 工作平台: -(-))(Verandah 陽台: -(-))	-	-	-	-	-	-	105.455 (1,135)	-	-	-
		D	138.746 (1,493) (Balcony 露台: 3.654(39))(Utility Platform 工作平台: -(-))(Verandah 陽台: -(-))	-	-	-	5.241 (56)	-	-	107.445 (1,157)	-	-	-

- The saleable area of the residential properties is calculated in accordance with Section 8 of the Residential Properties (First-hand Sales) Ordinance.
- The floor area of each of the balcony, utility platform and verandah, if any, to the extent that it forms part of a residential property, is calculated in accordance with Section 8 of the Residential Properties (First-hand Sales) Ordinance.
- The areas of other specified items (not included in the saleable area) are calculated in accordance with Part 2 of Schedule 2 to the Residential Properties (First-hand Sales) Ordinance.

Remarks:

- The areas in square feet have been converted from square metres based on a conversion rate of 1 square metre = 10.764 square feet and rounded off to the nearest integer.
- 4/F is omitted.

- 住宅物業的實用面積是按《一手住宅物業銷售條例》第8條計算得出的。
- 在構成住宅物業的一部分的範圍內的每一露台、工作平台及陽台(如有)之樓面面積是按《一手住宅物業銷售條例》第8條計算得出的。
- 其他指明項目的面積(不計算入實用面積)是按《一手住宅物業銷售條例》附表2第2部計算得出的。

備註:

- 以平方呎列出的面積由以平方米列出的面積以1平方米=10.764平方呎換算,並以四捨五入至整數。
- 不設4樓。

Area of residential properties in the development

發展項目中的住宅物業的面積

Description of Residential Property 物業的描述			Saleable Area (including balcony, utility platform and verandah, if any) sq. metre (sq. ft.) 實用面積 (包括露台、工作平台及陽台(如有))平方米(平方呎)	Area of other specified items (Not included in the Saleable Area) sq. metre (sq. ft.) 其他指明項目的面積(不計算入實用面積) 平方米(平方呎)									
Tower Number 座號	Floor 樓層	Flat 單位		Air-conditioning Plant Room 空調機房	Bay Window 窗台	Cockloft 閣樓	Flat Roof 平台	Garden 花園	Parking Space 停車位	Roof 天台	Stairhood 梯屋	Terrace 前庭	Yard 庭院
Tower 16 座	G/F 地下	A	160.918 (1,732) (Balcony 露台: -(-))(Utility Platform 工作平台: -(-))(Verandah 陽台: -(-))	-	-	-	-	103.534 (1,114)	-	-	-	-	-
		B	149.445 (1,609) (Balcony 露台: -(-))(Utility Platform 工作平台: -(-))(Verandah 陽台: -(-))	-	-	-	-	72.210 (777)	-	-	-	-	-
		C	154.083 (1,659) (Balcony 露台: -(-))(Utility Platform 工作平台: -(-))(Verandah 陽台: -(-))	-	-	-	-	41.541 (447)	-	-	-	-	-
		D	158.840 (1,710) (Balcony 露台: -(-))(Utility Platform 工作平台: -(-))(Verandah 陽台: -(-))	-	-	-	-	30.453 (328)	-	-	-	-	-
	1/F 1樓	A	170.616 (1,837) (Balcony 露台: 6.834(74))(Utility Platform 工作平台: 2.719(29))(Verandah 陽台: -(-))	-	-	-	-	-	-	-	-	-	-
		B	159.265 (1,714) (Balcony 露台: 9.820(106))(Utility Platform 工作平台: -(-))(Verandah 陽台: -(-))	-	-	-	-	-	-	-	-	-	-
		C	129.241 (1,391) (Balcony 露台: -(-))(Utility Platform 工作平台: 3.268(35))(Verandah 陽台: -(-))	-	-	-	8.616 (93)	-	-	-	-	-	-
		D	106.269 (1,144) (Balcony 露台: -(-))(Utility Platform 工作平台: 1.760(19))(Verandah 陽台: -(-))	-	-	-	9.780 (105)	-	-	-	-	-	-
		E	83.053 (894) (Balcony 露台: -(-))(Utility Platform 工作平台: -(-))(Verandah 陽台: -(-))	-	-	-	11.816 (127)	-	-	-	-	-	-
	2/F - 3/F, 5/F & 6/F 2樓-3樓、 5樓及6樓	A	170.616 (1,837) (Balcony 露台: 6.834(74))(Utility Platform 工作平台: 2.719(29))(Verandah 陽台: -(-))	-	-	-	-	-	-	-	-	-	-
		B	159.265 (1,714) (Balcony 露台: 9.820(106))(Utility Platform 工作平台: -(-))(Verandah 陽台: -(-))	-	-	-	-	-	-	-	-	-	-
		C	133.402 (1,436) (Balcony 露台: 4.161(45))(Utility Platform 工作平台: 3.268(35))(Verandah 陽台: -(-))	-	-	-	-	-	-	-	-	-	-
		D	109.923 (1,183) (Balcony 露台: 3.654(39))(Utility Platform 工作平台: 1.760(19))(Verandah 陽台: -(-))	-	-	-	-	-	-	-	-	-	-
		E	89.898 (968) (Balcony 露台: 3.097(33))(Utility Platform 工作平台: 3.748(40))(Verandah 陽台: -(-))	-	-	-	-	-	-	-	-	-	-
	7/F 7樓	A	170.988 (1,841) (Balcony 露台: 6.834(74))(Utility Platform 工作平台: 2.719(29))(Verandah 陽台: -(-))	-	-	-	-	-	-	129.951 (1,399)	-	-	-
		B	159.191 (1,714) (Balcony 露台: 9.820(106))(Utility Platform 工作平台: -(-))(Verandah 陽台: -(-))	-	-	-	-	-	-	153.045 (1,647)	-	-	-
		C	171.059 (1,841) (Balcony 露台: 4.137(45))(Utility Platform 工作平台: 3.268(35))(Verandah 陽台: -(-))	-	-	-	-	-	-	123.848 (1,333)	-	-	-
		D	138.746 (1,493) (Balcony 露台: 3.654(39))(Utility Platform 工作平台: -(-))(Verandah 陽台: -(-))	-	-	-	5.241 (56)	-	-	107.447 (1,157)	-	-	-

- The saleable area of the residential properties is calculated in accordance with Section 8 of the Residential Properties (First-hand Sales) Ordinance.
- The floor area of each of the balcony, utility platform and verandah, if any, to the extent that it forms part of a residential property, is calculated in accordance with Section 8 of the Residential Properties (First-hand Sales) Ordinance.
- The areas of other specified items (not included in the saleable area) are calculated in accordance with Part 2 of Schedule 2 to the Residential Properties (First-hand Sales) Ordinance.

Remarks:

- The areas in square feet have been converted from square metres based on a conversion rate of 1 square metre = 10.764 square feet and rounded off to the nearest integer.
- 4/F is omitted.

- 住宅物業的實用面積是按《一手住宅物業銷售條例》第8條計算得出的。
- 在構成住宅物業的一部分的範圍內的每一露台、工作平台及陽台(如有)之樓面面積是按《一手住宅物業銷售條例》第8條計算得出的。
- 其他指明項目的面積(不計算入實用面積)是按《一手住宅物業銷售條例》附表2第2部計算得出的。

備註:

- 以平方呎列出的面積由以平方米列出的面積以1平方米=10.764平方呎換算,並以四捨五入至整數。
- 不設4樓。

Area of residential properties in the development

發展項目中的住宅物業的面積

Description of Residential Property 物業的描述			Saleable Area (including balcony, utility platform and verandah, if any) sq. metre (sq. ft.) 實用面積 (包括露台、工作平台及陽台(如有))平方米(平方呎)	Area of other specified items (Not included in the Saleable Area) sq. metre (sq. ft.) 其他指明項目的面積(不計算入實用面積) 平方米(平方呎)									
Tower Number 座號	Floor 樓層	Flat 單位		Air-conditioning Plant Room 空調機房	Bay Window 窗台	Cockloft 閣樓	Flat Roof 平台	Garden 花園	Parking Space 停車位	Roof 天台	Stairhood 梯屋	Terrace 前庭	Yard 庭院
Tower 17 座	G/F 地下	A	109.029 (1,174) (Balcony 露台: -(-))(Utility Platform 工作平台: -(-))(Verandah 陽台: -(-))	-	-	-	-	53.250 (573)	-	-	-	-	-
		B	99.168 (1,067) (Balcony 露台: -(-))(Utility Platform 工作平台: -(-))(Verandah 陽台: -(-))	-	-	-	-	48.351 (520)	-	-	-	-	-
		C	82.686 (890) (Balcony 露台: -(-))(Utility Platform 工作平台: -(-))(Verandah 陽台: -(-))	-	-	-	-	21.702 (234)	-	-	-	-	-
		D	93.252 (1,004) (Balcony 露台: -(-))(Utility Platform 工作平台: -(-))(Verandah 陽台: -(-))	-	-	-	-	19.647 (211)	-	-	-	-	-
	1/F 1樓	A	120.831 (1,301) (Balcony 露台: 3.510(38))(Utility Platform 工作平台: 2.695(29))(Verandah 陽台: -(-))	-	-	-	-	-	-	-	-	-	-
		B	112.941 (1,216) (Balcony 露台: 7.408(80))(Utility Platform 工作平台: 1.501(16))(Verandah 陽台: -(-))	-	-	-	-	-	-	-	-	-	-
		C	81.103 (873) (Balcony 露台: -(-))(Utility Platform 工作平台: 1.510(16))(Verandah 陽台: -(-))	-	-	-	2.152 (23)	-	-	-	-	-	-
		D	91.252 (982) (Balcony 露台: -(-))(Utility Platform 工作平台: 1.510(16))(Verandah 陽台: -(-))	-	-	-	2.205 (24)	-	-	-	-	-	-
	2/F - 3/F & 5/F 2樓-3樓及5樓	A	120.831 (1,301) (Balcony 露台: 3.510(38))(Utility Platform 工作平台: 2.695(29))(Verandah 陽台: -(-))	-	-	-	-	-	-	-	-	-	-
		B	112.941 (1,216) (Balcony 露台: 7.408(80))(Utility Platform 工作平台: 1.501(16))(Verandah 陽台: -(-))	-	-	-	-	-	-	-	-	-	-
		C	84.195 (906) (Balcony 露台: 3.092(33))(Utility Platform 工作平台: 1.510(16))(Verandah 陽台: -(-))	-	-	-	-	-	-	-	-	-	-
		D	94.418 (1,016) (Balcony 露台: 3.166(34))(Utility Platform 工作平台: 1.510(16))(Verandah 陽台: -(-))	-	-	-	-	-	-	-	-	-	-
	6/F 6樓	A	120.831 (1,301) (Balcony 露台: 3.510(38))(Utility Platform 工作平台: 2.695(29))(Verandah 陽台: -(-))	-	-	-	-	-	-	104.318 (1,123)	-	-	-
		B	112.941 (1,216) (Balcony 露台: 7.408(80))(Utility Platform 工作平台: 1.501(16))(Verandah 陽台: -(-))	-	-	-	-	-	-	89.858 (967)	-	-	-
		C	84.195 (906) (Balcony 露台: 3.092(33))(Utility Platform 工作平台: 1.510(16))(Verandah 陽台: -(-))	-	-	-	-	-	-	67.010 (721)	-	-	-
		D	94.418 (1,016) (Balcony 露台: 3.166(34))(Utility Platform 工作平台: 1.510(16))(Verandah 陽台: -(-))	-	-	-	-	-	-	81.251 (875)	-	-	-

- The saleable area of the residential properties is calculated in accordance with Section 8 of the Residential Properties (First-hand Sales) Ordinance.
- The floor area of each of the balcony, utility platform and verandah, if any, to the extent that it forms part of a residential property, is calculated in accordance with Section 8 of the Residential Properties (First-hand Sales) Ordinance.
- The areas of other specified items (not included in the saleable area) are calculated in accordance with Part 2 of Schedule 2 to the Residential Properties (First-hand Sales) Ordinance.

Remarks:

- The areas in square feet have been converted from square metres based on a conversion rate of 1 square metre = 10.764 square feet and rounded off to the nearest integer.
- 4/F is omitted.

- 住宅物業的實用面積是按《一手住宅物業銷售條例》第8條計算得出的。
- 在構成住宅物業的一部分的範圍內的每一露台、工作平台及陽台(如有)之樓面面積是按《一手住宅物業銷售條例》第8條計算得出的。
- 其他指明項目的面積(不計算入實用面積)是按《一手住宅物業銷售條例》附表2第2部計算得出的。

備註:

- 以平方呎列出的面積由以平方米列出的面積以1平方米=10.764平方呎換算,並以四捨五入至整數。
- 不設4樓。

Area of residential properties in the development

發展項目中的住宅物業的面積

Description of Residential Property 物業的描述			Saleable Area (including balcony, utility platform and verandah, if any) sq. metre (sq. ft.) 實用面積 (包括露台、工作平台及陽台(如有))平方米(平方呎)	Area of other specified items (Not included in the Saleable Area) sq. metre (sq. ft.) 其他指明項目的面積(不計算入實用面積) 平方米(平方呎)									
Tower Number 座號	Floor 樓層	Flat 單位		Air-conditioning Plant Room 空調機房	Bay Window 窗台	Cockloft 閣樓	Flat Roof 平台	Garden 花園	Parking Space 停車位	Roof 天台	Stairhood 梯屋	Terrace 前庭	Yard 庭院
Tower 18 座	G/F 地下	A	100.008 (1,076) (Balcony 露台: -(-))(Utility Platform 工作平台: -(-))(Verandah 陽台: -(-))	-	-	-	-	69.649 (750)	-	-	-	-	-
		B	102.971 (1,108) (Balcony 露台: -(-))(Utility Platform 工作平台: -(-))(Verandah 陽台: -(-))	-	-	-	-	50.887 (548)	-	-	-	-	-
		C	82.920 (893) (Balcony 露台: -(-))(Utility Platform 工作平台: -(-))(Verandah 陽台: -(-))	-	-	-	-	21.986 (237)	-	-	-	-	-
		D	82.894 (892) (Balcony 露台: -(-))(Utility Platform 工作平台: -(-))(Verandah 陽台: -(-))	-	-	-	-	22.450 (242)	-	-	-	-	-
	1/F 1樓	A	107.862 (1,161) (Balcony 露台: 2.236(24))(Utility Platform 工作平台: 1.512(16))(Verandah 陽台: -(-))	-	-	-	-	-	-	-	-	-	-
		B	107.715 (1,159) (Balcony 露台: 2.236(24))(Utility Platform 工作平台: 1.512(16))(Verandah 陽台: -(-))	-	-	-	-	-	-	-	-	-	-
		C	80.831 (870) (Balcony 露台: -(-))(Utility Platform 工作平台: 1.510(16))(Verandah 陽台: -(-))	-	-	-	2,144 (23)	-	-	-	-	-	-
		D	81.063 (873) (Balcony 露台: -(-))(Utility Platform 工作平台: 1.510(16))(Verandah 陽台: -(-))	-	-	-	2,152 (23)	-	-	-	-	-	-
	2/F - 3/F & 5/F 2樓-3樓及5樓	A	107.862 (1,161) (Balcony 露台: 2.236(24))(Utility Platform 工作平台: 1.512(16))(Verandah 陽台: -(-))	-	-	-	-	-	-	-	-	-	-
		B	107.937 (1,162) (Balcony 露台: 2.236(24))(Utility Platform 工作平台: 1.512(16))(Verandah 陽台: -(-))	-	-	-	-	-	-	-	-	-	-
		C	83.914 (903) (Balcony 露台: 3.082(33))(Utility Platform 工作平台: 1.510(16))(Verandah 陽台: -(-))	-	-	-	-	-	-	-	-	-	-
		D	84.155 (906) (Balcony 露台: 3.092(33))(Utility Platform 工作平台: 1.510(16))(Verandah 陽台: -(-))	-	-	-	-	-	-	-	-	-	-
	6/F 6樓	A	107.862 (1,161) (Balcony 露台: 2.236(24))(Utility Platform 工作平台: 1.512(16))(Verandah 陽台: -(-))	-	-	-	-	-	-	89.056 (959)	-	-	-
		B	107.937 (1,162) (Balcony 露台: 2.236(24))(Utility Platform 工作平台: 1.512(16))(Verandah 陽台: -(-))	-	-	-	-	-	-	93.606 (1,008)	-	-	-
		C	83.914 (903) (Balcony 露台: 3.082(33))(Utility Platform 工作平台: 1.510(16))(Verandah 陽台: -(-))	-	-	-	-	-	-	70.532 (759)	-	-	-
		D	84.155 (906) (Balcony 露台: 3.092(33))(Utility Platform 工作平台: 1.510(16))(Verandah 陽台: -(-))	-	-	-	-	-	-	67.318 (725)	-	-	-

- The saleable area of the residential properties is calculated in accordance with Section 8 of the Residential Properties (First-hand Sales) Ordinance.
- The floor area of each of the balcony, utility platform and verandah, if any, to the extent that it forms part of a residential property, is calculated in accordance with Section 8 of the Residential Properties (First-hand Sales) Ordinance.
- The areas of other specified items (not included in the saleable area) are calculated in accordance with Part 2 of Schedule 2 to the Residential Properties (First-hand Sales) Ordinance.

Remarks:

- The areas in square feet have been converted from square metres based on a conversion rate of 1 square metre = 10.764 square feet and rounded off to the nearest integer.
- 4/F is omitted.

- 住宅物業的實用面積是按《一手住宅物業銷售條例》第8條計算得出的。
- 在構成住宅物業的一部分的範圍內的每一露台、工作平台及陽台(如有)之樓面面積是按《一手住宅物業銷售條例》第8條計算得出的。
- 其他指明項目的面積(不計算入實用面積)是按《一手住宅物業銷售條例》附表2第2部計算得出的。

備註:

- 以平方呎列出的面積由以平方米列出的面積以1平方米=10.764平方呎換算,並以四捨五入至整數。
- 不設4樓。

Area of residential properties in the development

發展項目中的住宅物業的面積

Description of Residential Property 物業的描述			Saleable Area (including balcony, utility platform and verandah, if any) sq. metre (sq. ft.) 實用面積 (包括露台、工作平台及陽台(如有))平方米(平方呎)	Area of other specified items (Not included in the Saleable Area) sq. metre (sq. ft.) 其他指明項目的面積(不計算入實用面積) 平方米(平方呎)									
Tower Number 座號	Floor 樓層	Flat 單位		Air-conditioning Plant Room 空調機房	Bay Window 窗台	Cockloft 閣樓	Flat Roof 平台	Garden 花園	Parking Space 停車位	Roof 天台	Stairhood 梯屋	Terrace 前庭	Yard 庭院
Tower 19 座	G/F 地下	A	102.971 (1,108) (Balcony 露台: -(-))(Utility Platform 工作平台: -(-))(Verandah 陽台: -(-))	-	-	-	-	50.871 (548)	-	-	-	-	-
		B	100.083 (1,077) (Balcony 露台: -(-))(Utility Platform 工作平台: -(-))(Verandah 陽台: -(-))	-	-	-	-	50.871 (548)	-	-	-	-	-
		C	82.894 (892) (Balcony 露台: -(-))(Utility Platform 工作平台: -(-))(Verandah 陽台: -(-))	-	-	-	-	20.865 (225)	-	-	-	-	-
		D	82.920 (893) (Balcony 露台: -(-))(Utility Platform 工作平台: -(-))(Verandah 陽台: -(-))	-	-	-	-	18.524 (199)	-	-	-	-	-
	1/F 1樓	A	107.715 (1,159) (Balcony 露台: 2.236(24))(Utility Platform 工作平台: 1.512(16))(Verandah 陽台: -(-))	-	-	-	-	-	-	-	-	-	-
		B	107.937 (1,162) (Balcony 露台: 2.236(24))(Utility Platform 工作平台: 1.512(16))(Verandah 陽台: -(-))	-	-	-	-	-	-	-	-	-	-
		C	81.063 (873) (Balcony 露台: -(-))(Utility Platform 工作平台: 1.510(16))(Verandah 陽台: -(-))	-	-	-	2.152 (23)	-	-	-	-	-	-
		D	80.831 (870) (Balcony 露台: -(-))(Utility Platform 工作平台: 1.510(16))(Verandah 陽台: -(-))	-	-	-	2.144 (23)	-	-	-	-	-	-
	2/F - 3/F & 5/F 2樓-3樓及5樓	A	107.937 (1,162) (Balcony 露台: 2.236(24))(Utility Platform 工作平台: 1.512(16))(Verandah 陽台: -(-))	-	-	-	-	-	-	-	-	-	-
		B	107.937 (1,162) (Balcony 露台: 2.236(24))(Utility Platform 工作平台: 1.512(16))(Verandah 陽台: -(-))	-	-	-	-	-	-	-	-	-	-
		C	84.155 (906) (Balcony 露台: 3.092(33))(Utility Platform 工作平台: 1.510(16))(Verandah 陽台: -(-))	-	-	-	-	-	-	-	-	-	-
		D	83.914 (903) (Balcony 露台: 3.082(33))(Utility Platform 工作平台: 1.510(16))(Verandah 陽台: -(-))	-	-	-	-	-	-	-	-	-	-
	6/F 6樓	A	107.937 (1,162) (Balcony 露台: 2.236(24))(Utility Platform 工作平台: 1.512(16))(Verandah 陽台: -(-))	-	-	-	-	-	-	93.606 (1,008)	-	-	-
		B	107.937 (1,162) (Balcony 露台: 2.236(24))(Utility Platform 工作平台: 1.512(16))(Verandah 陽台: -(-))	-	-	-	-	-	-	89.056 (959)	-	-	-
		C	84.155 (906) (Balcony 露台: 3.092(33))(Utility Platform 工作平台: 1.510(16))(Verandah 陽台: -(-))	-	-	-	-	-	-	67.318 (725)	-	-	-
		D	83.914 (903) (Balcony 露台: 3.082(33))(Utility Platform 工作平台: 1.510(16))(Verandah 陽台: -(-))	-	-	-	-	-	-	70.532 (759)	-	-	-

- The saleable area of the residential properties is calculated in accordance with Section 8 of the Residential Properties (First-hand Sales) Ordinance.
- The floor area of each of the balcony, utility platform and verandah, if any, to the extent that it forms part of a residential property, is calculated in accordance with Section 8 of the Residential Properties (First-hand Sales) Ordinance.
- The areas of other specified items (not included in the saleable area) are calculated in accordance with Part 2 of Schedule 2 to the Residential Properties (First-hand Sales) Ordinance.

Remarks:

- The areas in square feet have been converted from square metres based on a conversion rate of 1 square metre = 10.764 square feet and rounded off to the nearest integer.
- 4/F is omitted.

- 住宅物業的實用面積是按《一手住宅物業銷售條例》第8條計算得出的。
- 在構成住宅物業的一部分的範圍內的每一露台、工作平台及陽台(如有)之樓面面積是按《一手住宅物業銷售條例》第8條計算得出的。
- 其他指明項目的面積(不計算入實用面積)是按《一手住宅物業銷售條例》附表2第2部計算得出的。

備註:

- 以平方呎列出的面積由以平方米列出的面積以1平方米=10.764平方呎換算,並以四捨五入至整數。
- 不設4樓。

Area of residential properties in the development

發展項目中的住宅物業的面積

Description of Residential Property 物業的描述			Saleable Area (including balcony, utility platform and verandah, if any) sq. metre (sq. ft.) 實用面積 (包括露台、工作平台及陽台(如有))平方米(平方呎)	Area of other specified items (Not included in the Saleable Area) sq. metre (sq. ft.) 其他指明項目的面積(不計算入實用面積) 平方米(平方呎)									
Tower Number 座號	Floor 樓層	Flat 單位		Air-conditioning Plant Room 空調機房	Bay Window 窗台	Cockloft 閣樓	Flat Roof 平台	Garden 花園	Parking Space 停車位	Roof 天台	Stairhood 梯屋	Terrace 前庭	Yard 庭院
Tower 20 座	G/F 地下	A	100.083 (1,077) (Balcony 露台: -(-))(Utility Platform 工作平台: -(-))(Verandah 陽台: -(-))	-	-	-	-	50.885 (548)	-	-	-	-	-
		B	102.971 (1,108) (Balcony 露台: -(-))(Utility Platform 工作平台: -(-))(Verandah 陽台: -(-))	-	-	-	-	50.888 (548)	-	-	-	-	-
		C	82.920 (893) (Balcony 露台: -(-))(Utility Platform 工作平台: -(-))(Verandah 陽台: -(-))	-	-	-	-	23.547 (253)	-	-	-	-	-
		D	82.894 (892) (Balcony 露台: -(-))(Utility Platform 工作平台: -(-))(Verandah 陽台: -(-))	-	-	-	-	23.547 (253)	-	-	-	-	-
	1/F 1樓	A	107.937 (1,162) (Balcony 露台: 2.236(24))(Utility Platform 工作平台: 1.512(16))(Verandah 陽台: -(-))	-	-	-	-	-	-	-	-	-	-
		B	107.715 (1,159) (Balcony 露台: 2.236(24))(Utility Platform 工作平台: 1.512(16))(Verandah 陽台: -(-))	-	-	-	-	-	-	-	-	-	-
		C	80.831 (870) (Balcony 露台: -(-))(Utility Platform 工作平台: 1.510(16))(Verandah 陽台: -(-))	-	-	-	2,144 (23)	-	-	-	-	-	-
		D	81.063 (873) (Balcony 露台: -(-))(Utility Platform 工作平台: 1.510(16))(Verandah 陽台: -(-))	-	-	-	2,152 (23)	-	-	-	-	-	-
	2/F - 3/F & 5/F 2樓-3樓及5樓	A	107.937 (1,162) (Balcony 露台: 2.236(24))(Utility Platform 工作平台: 1.512(16))(Verandah 陽台: -(-))	-	-	-	-	-	-	-	-	-	-
		B	107.937 (1,162) (Balcony 露台: 2.236(24))(Utility Platform 工作平台: 1.512(16))(Verandah 陽台: -(-))	-	-	-	-	-	-	-	-	-	-
		C	83.914 (903) (Balcony 露台: 3.082(33))(Utility Platform 工作平台: 1.510(16))(Verandah 陽台: -(-))	-	-	-	-	-	-	-	-	-	-
		D	84.155 (906) (Balcony 露台: 3.092(33))(Utility Platform 工作平台: 1.510(16))(Verandah 陽台: -(-))	-	-	-	-	-	-	-	-	-	-
	6/F 6樓	A	107.937 (1,162) (Balcony 露台: 2.236(24))(Utility Platform 工作平台: 1.512(16))(Verandah 陽台: -(-))	-	-	-	-	-	-	89.056 (959)	-	-	-
		B	107.937 (1,162) (Balcony 露台: 2.236(24))(Utility Platform 工作平台: 1.512(16))(Verandah 陽台: -(-))	-	-	-	-	-	-	93.606 (1,008)	-	-	-
		C	83.914 (903) (Balcony 露台: 3.082(33))(Utility Platform 工作平台: 1.510(16))(Verandah 陽台: -(-))	-	-	-	-	-	-	70.532 (759)	-	-	-
		D	84.155 (906) (Balcony 露台: 3.092(33))(Utility Platform 工作平台: 1.510(16))(Verandah 陽台: -(-))	-	-	-	-	-	-	67.318 (725)	-	-	-

- Remarks:
- The areas in square feet have been converted from square metres based on a conversion rate of 1 square metre = 10.764 square feet and rounded off to the nearest integer.
 - 4/F is omitted.

- 住宅物業的實用面積是按《一手住宅物業銷售條例》第8條計算得出的。
- 在構成住宅物業的一部分的範圍內的每一露台、工作平台及陽台(如有)之樓面面積是按《一手住宅物業銷售條例》第8條計算得出的。
- 其他指明項目的面積(不計算入實用面積)是按《一手住宅物業銷售條例》附表2第2部計算得出的。

備註:

- 以平方呎列出的面積由以平方米列出的面積以1平方米=10.764平方呎換算,並以四捨五入至整數。
- 不設4樓。

Area of residential properties in the development

發展項目中的住宅物業的面積

Description of Residential Property 物業的描述			Saleable Area (including balcony, utility platform and verandah, if any) sq. metre (sq. ft.) 實用面積 (包括露台、工作平台及陽台(如有))平方米(平方呎)	Area of other specified items (Not included in the Saleable Area) sq. metre (sq. ft.) 其他指明項目的面積(不計算入實用面積) 平方米(平方呎)									
Tower Number 座號	Floor 樓層	Flat 單位		Air-conditioning Plant Room 空調機房	Bay Window 窗台	Cockloft 閣樓	Flat Roof 平台	Garden 花園	Parking Space 停車位	Roof 天台	Stairhood 梯屋	Terrace 前庭	Yard 庭院
Tower 21 座	G/F 地下	A	102.971 (1,108) (Balcony 露台: -(-))(Utility Platform 工作平台: -(-))(Verandah 陽台: -(-))	-	-	-	-	50.884 (548)	-	-	-	-	-
		B	100.083 (1,077) (Balcony 露台: -(-))(Utility Platform 工作平台: -(-))(Verandah 陽台: -(-))	-	-	-	-	50.887 (548)	-	-	-	-	-
		C	82.894 (892) (Balcony 露台: -(-))(Utility Platform 工作平台: -(-))(Verandah 陽台: -(-))	-	-	-	-	23.560 (254)	-	-	-	-	-
		D	82.920 (893) (Balcony 露台: -(-))(Utility Platform 工作平台: -(-))(Verandah 陽台: -(-))	-	-	-	-	23.560 (254)	-	-	-	-	-
	1/F 1樓	A	107.715 (1,159) (Balcony 露台: 2.236(24))(Utility Platform 工作平台: 1.512(16))(Verandah 陽台: -(-))	-	-	-	-	-	-	-	-	-	-
		B	107.937 (1,162) (Balcony 露台: 2.236(24))(Utility Platform 工作平台: 1.512(16))(Verandah 陽台: -(-))	-	-	-	-	-	-	-	-	-	-
		C	81.063 (873) (Balcony 露台: -(-))(Utility Platform 工作平台: 1.510(16))(Verandah 陽台: -(-))	-	-	-	2.152 (23)	-	-	-	-	-	-
		D	80.831 (870) (Balcony 露台: -(-))(Utility Platform 工作平台: 1.510(16))(Verandah 陽台: -(-))	-	-	-	2.144 (23)	-	-	-	-	-	-
	2/F - 3/F & 5/F 2樓-3樓及5樓	A	107.937 (1,162) (Balcony 露台: 2.236(24))(Utility Platform 工作平台: 1.512(16))(Verandah 陽台: -(-))	-	-	-	-	-	-	-	-	-	-
		B	107.937 (1,162) (Balcony 露台: 2.236(24))(Utility Platform 工作平台: 1.512(16))(Verandah 陽台: -(-))	-	-	-	-	-	-	-	-	-	-
		C	84.155 (906) (Balcony 露台: 3.092(33))(Utility Platform 工作平台: 1.510(16))(Verandah 陽台: -(-))	-	-	-	-	-	-	-	-	-	-
		D	83.914 (903) (Balcony 露台: 3.082(33))(Utility Platform 工作平台: 1.510(16))(Verandah 陽台: -(-))	-	-	-	-	-	-	-	-	-	-
	6/F 6樓	A	107.937 (1,162) (Balcony 露台: 2.236(24))(Utility Platform 工作平台: 1.512(16))(Verandah 陽台: -(-))	-	-	-	-	-	-	93.606 (1,008)	-	-	-
		B	107.937 (1,162) (Balcony 露台: 2.236(24))(Utility Platform 工作平台: 1.512(16))(Verandah 陽台: -(-))	-	-	-	-	-	-	89.056 (959)	-	-	-
		C	84.155 (906) (Balcony 露台: 3.092(33))(Utility Platform 工作平台: 1.510(16))(Verandah 陽台: -(-))	-	-	-	-	-	-	67.318 (725)	-	-	-
		D	83.914 (903) (Balcony 露台: 3.082(33))(Utility Platform 工作平台: 1.510(16))(Verandah 陽台: -(-))	-	-	-	-	-	-	70.532 (759)	-	-	-

- The saleable area of the residential properties is calculated in accordance with Section 8 of the Residential Properties (First-hand Sales) Ordinance.
- The floor area of each of the balcony, utility platform and verandah, if any, to the extent that it forms part of a residential property, is calculated in accordance with Section 8 of the Residential Properties (First-hand Sales) Ordinance.
- The areas of other specified items (not included in the saleable area) are calculated in accordance with Part 2 of Schedule 2 to the Residential Properties (First-hand Sales) Ordinance.

Remarks:

- The areas in square feet have been converted from square metres based on a conversion rate of 1 square metre = 10.764 square feet and rounded off to the nearest integer.
- 4/F is omitted.

- 住宅物業的實用面積是按《一手住宅物業銷售條例》第8條計算得出的。
- 在構成住宅物業的一部分的範圍內的每一露台、工作平台及陽台(如有)之樓面面積是按《一手住宅物業銷售條例》第8條計算得出的。
- 其他指明項目的面積(不計算入實用面積)是按《一手住宅物業銷售條例》附表2第2部計算得出的。

備註:

- 以平方呎列出的面積由以平方米列出的面積以1平方米=10.764平方呎換算,並以四捨五入至整數。
- 不設4樓。

Area of residential properties in the development

發展項目中的住宅物業的面積

Description of Residential Property 物業的描述			Saleable Area (including balcony, utility platform and verandah, if any) sq. metre (sq. ft.) 實用面積 (包括露台、工作平台及陽台(如有))平方米(平方呎)	Area of other specified items (Not included in the Saleable Area) sq. metre (sq. ft.) 其他指明項目的面積(不計算入實用面積) 平方米(平方呎)									
Tower Number 座號	Floor 樓層	Flat 單位		Air-conditioning Plant Room 空調機房	Bay Window 窗台	Cockloft 閣樓	Flat Roof 平台	Garden 花園	Parking Space 停車位	Roof 天台	Stairhood 梯屋	Terrace 前庭	Yard 庭院
Tower 22 座	G/F 地下	A	97.145 (1,046) (Balcony 露台: -)(Utility Platform 工作平台: -)(Verandah 陽台: -)	-	-	-	-	43.768 (471)	-	-	-	-	-
		B	63.327 (682) (Balcony 露台: -)(Utility Platform 工作平台: -)(Verandah 陽台: -)	-	-	-	-	22.094 (238)	-	-	-	-	-
		C	38.024 (409) (Balcony 露台: -)(Utility Platform 工作平台: -)(Verandah 陽台: -)	-	-	-	-	15.055 (162)	-	-	-	-	-
		D	62.642 (674) (Balcony 露台: -)(Utility Platform 工作平台: -)(Verandah 陽台: -)	-	-	-	-	20.298 (218)	-	-	-	-	-
	1/F 1樓	A	109.005 (1,173) (Balcony 露台: 6.876(74))(Utility Platform 工作平台: 2.634(28))(Verandah 陽台: -)	-	-	-	-	-	-	-	-	-	-
		B	43.525 (469) (Balcony 露台: 2.975(32))(Utility Platform 工作平台: 1.509(16))(Verandah 陽台: -)	-	-	-	-	-	-	-	-	-	-
		C	42.769 (460) (Balcony 露台: 2.975(32))(Utility Platform 工作平台: 1.508(16))(Verandah 陽台: -)	-	-	-	-	-	-	-	-	-	-
		D	42.444 (457) (Balcony 露台: 2.975(32))(Utility Platform 工作平台: 1.504(16))(Verandah 陽台: -)	-	-	-	-	-	-	-	-	-	-
		E	67.437 (726) (Balcony 露台: 3.075(33))(Utility Platform 工作平台: 1.595(17))(Verandah 陽台: -)	-	-	-	-	-	-	-	-	-	-
	2/F 2樓	A	109.005 (1,173) (Balcony 露台: 6.876(74))(Utility Platform 工作平台: 2.634(28))(Verandah 陽台: -)	-	-	-	-	-	-	-	-	-	-
		B	43.525 (469) (Balcony 露台: 2.975(32))(Utility Platform 工作平台: 1.509(16))(Verandah 陽台: -)	-	-	-	-	-	-	-	-	-	-
		C	42.769 (460) (Balcony 露台: 2.975(32))(Utility Platform 工作平台: 1.508(16))(Verandah 陽台: -)	-	-	-	-	-	-	-	-	-	-
		D	42.444 (457) (Balcony 露台: 2.975(32))(Utility Platform 工作平台: 1.504(16))(Verandah 陽台: -)	-	-	-	-	-	-	-	-	-	-
		E	67.437 (726) (Balcony 露台: 3.075(33))(Utility Platform 工作平台: 1.595(17))(Verandah 陽台: -)	-	-	-	-	-	-	-	-	-	-
	3/F 3樓	A	109.005 (1,173) (Balcony 露台: 6.876(74))(Utility Platform 工作平台: 2.634(28))(Verandah 陽台: -)	-	-	-	-	-	-	87.946 (947)	-	-	-
		B	43.525 (469) (Balcony 露台: 2.975(32))(Utility Platform 工作平台: 1.509(16))(Verandah 陽台: -)	-	-	-	-	-	-	34.854 (375)	-	-	-
		C	42.769 (460) (Balcony 露台: 2.975(32))(Utility Platform 工作平台: 1.508(16))(Verandah 陽台: -)	-	-	-	-	-	-	34.854 (375)	-	-	-
		D	42.444 (457) (Balcony 露台: 2.975(32))(Utility Platform 工作平台: 1.504(16))(Verandah 陽台: -)	-	-	-	-	-	-	35.357 (381)	-	-	-
		E	67.437 (726) (Balcony 露台: 3.075(33))(Utility Platform 工作平台: 1.595(17))(Verandah 陽台: -)	-	-	-	-	-	-	55.485 (597)	-	-	-

- The saleable area of the residential properties is calculated in accordance with Section 8 of the Residential Properties (First-hand Sales) Ordinance.
- The floor area of each of the balcony, utility platform and verandah, if any, to the extent that it forms part of a residential property, is calculated in accordance with Section 8 of the Residential Properties (First-hand Sales) Ordinance.
- The areas of other specified items (not included in the saleable area) are calculated in accordance with Part 2 of Schedule 2 to the Residential Properties (First-hand Sales) Ordinance.

Remarks:

- The areas in square feet have been converted from square metres based on a conversion rate of 1 square metre = 10.764 square feet and rounded off to the nearest integer.
- 4/F is omitted.

- 住宅物業的實用面積是按《一手住宅物業銷售條例》第8條計算得出的。
- 在構成住宅物業的一部分的範圍內的每一露台、工作平台及陽台(如有)之樓面面積是按《一手住宅物業銷售條例》第8條計算得出的。
- 其他指明項目的面積(不計算入實用面積)是按《一手住宅物業銷售條例》附表2第2部計算得出的。

備註:

- 以平方呎列出的面積由以平方米列出的面積以1平方米=10.764平方呎換算,並以四捨五入至整數。
- 不設4樓。

Area of residential properties in the development

發展項目中的住宅物業的面積

Description of Residential Property 物業的描述			Saleable Area (including balcony, utility platform and verandah, if any) sq. metre (sq. ft.) 實用面積 (包括露台、工作平台及陽台(如有))平方米(平方呎)	Area of other specified items (Not included in the Saleable Area) sq. metre (sq. ft.) 其他指明項目的面積(不計算入實用面積) 平方米(平方呎)									
Tower Number 座號	Floor 樓層	Flat 單位		Air-conditioning Plant Room 空調機房	Bay Window 窗台	Cockloft 閣樓	Flat Roof 平台	Garden 花園	Parking Space 停車位	Roof 天台	Stairhood 梯屋	Terrace 前庭	Yard 庭院
Tower 23 座	G/F 地下	A	62.643 (674) (Balcony 露台: -(-))(Utility Platform 工作平台: -(-))(Verandah 陽台: -(-))	-	-	-	-	20.298 (218)	-	-	-	-	-
		B	38.024 (409) (Balcony 露台: -(-))(Utility Platform 工作平台: -(-))(Verandah 陽台: -(-))	-	-	-	-	15.057 (162)	-	-	-	-	-
		C	63.327 (682) (Balcony 露台: -(-))(Utility Platform 工作平台: -(-))(Verandah 陽台: -(-))	-	-	-	-	29.512 (318)	-	-	-	-	-
		D	38.025 (409) (Balcony 露台: -(-))(Utility Platform 工作平台: -(-))(Verandah 陽台: -(-))	-	-	-	-	15.057 (162)	-	-	-	-	-
		E	62.643 (674) (Balcony 露台: -(-))(Utility Platform 工作平台: -(-))(Verandah 陽台: -(-))	-	-	-	-	27.049 (291)	-	-	-	-	-
	1/F 1樓	A	67.438 (726) (Balcony 露台: 3.075(33))(Utility Platform 工作平台: 1.595(17))(Verandah 陽台: -(-))	-	-	-	-	-	-	-	-	-	-
		B	42.444 (457) (Balcony 露台: 2.975(32))(Utility Platform 工作平台: 1.504(16))(Verandah 陽台: -(-))	-	-	-	-	-	-	-	-	-	-
		C	42.770 (460) (Balcony 露台: 2.975(32))(Utility Platform 工作平台: 1.509(16))(Verandah 陽台: -(-))	-	-	-	-	-	-	-	-	-	-
		D	42.770 (460) (Balcony 露台: 2.975(32))(Utility Platform 工作平台: 1.509(16))(Verandah 陽台: -(-))	-	-	-	-	-	-	-	-	-	-
		E	42.444 (457) (Balcony 露台: 2.975(32))(Utility Platform 工作平台: 1.504(16))(Verandah 陽台: -(-))	-	-	-	-	-	-	-	-	-	-
		F	67.439 (726) (Balcony 露台: 3.075(33))(Utility Platform 工作平台: 1.595(17))(Verandah 陽台: -(-))	-	-	-	-	-	-	-	-	-	-

- Remarks:
- The saleable area of the residential properties is calculated in accordance with Section 8 of the Residential Properties (First-hand Sales) Ordinance.
 - The floor area of each of the balcony, utility platform and verandah, if any, to the extent that it forms part of a residential property, is calculated in accordance with Section 8 of the Residential Properties (First-hand Sales) Ordinance.
 - The areas of other specified items (not included in the saleable area) are calculated in accordance with Part 2 of Schedule 2 to the Residential Properties (First-hand Sales) Ordinance.

- The areas in square feet have been converted from square metres based on a conversion rate of 1 square metre = 10.764 square feet and rounded off to the nearest integer.
- 4/F is omitted.

- 住宅物業的實用面積是按《一手住宅物業銷售條例》第8條計算得出的。
- 在構成住宅物業的一部分的範圍內的每一露台、工作平台及陽台(如有)之樓面面積是按《一手住宅物業銷售條例》第8條計算得出的。
- 其他指明項目的面積(不計算入實用面積)是按《一手住宅物業銷售條例》附表2第2部計算得出的。

備註:

- 以平方呎列出的面積由以平方米列出的面積以1平方米=10.764平方呎換算,並以四捨五入至整數。
- 不設4樓。

Area of residential properties in the development

發展項目中的住宅物業的面積

Description of Residential Property 物業的描述			Saleable Area (including balcony, utility platform and verandah, if any) sq. metre (sq. ft.) 實用面積 (包括露台、工作平台及陽台(如有))平方米(平方呎)	Area of other specified items (Not included in the Saleable Area) sq. metre (sq. ft.) 其他指明項目的面積(不計算入實用面積) 平方米(平方呎)									
Tower Number 座號	Floor 樓層	Flat 單位		Air-conditioning Plant Room 空調機房	Bay Window 窗台	Cockloft 閣樓	Flat Roof 平台	Garden 花園	Parking Space 停車位	Roof 天台	Stairhood 梯屋	Terrace 前庭	Yard 庭院
Tower 23 座	2/F 2樓	A	67.438 (726) (Balcony 露台: 3.075(33))(Utility Platform 工作平台: 1.595(17))(Verandah 陽台: -(-))	-	-	-	-	-	-	-	-	-	-
		B	42.444 (457) (Balcony 露台: 2.975(32))(Utility Platform 工作平台: 1.504(16))(Verandah 陽台: -(-))	-	-	-	-	-	-	-	-	-	-
		C	42.770 (460) (Balcony 露台: 2.975(32))(Utility Platform 工作平台: 1.509(16))(Verandah 陽台: -(-))	-	-	-	-	-	-	-	-	-	-
		D	42.770 (460) (Balcony 露台: 2.975(32))(Utility Platform 工作平台: 1.509(16))(Verandah 陽台: -(-))	-	-	-	-	-	-	-	-	-	-
		E	42.444 (457) (Balcony 露台: 2.975(32))(Utility Platform 工作平台: 1.504(16))(Verandah 陽台: -(-))	-	-	-	-	-	-	-	-	-	-
		F	67.439 (726) (Balcony 露台: 3.075(33))(Utility Platform 工作平台: 1.595(17))(Verandah 陽台: -(-))	-	-	-	-	-	-	-	-	-	-
	3/F 3樓	A	67.438 (726) (Balcony 露台: 3.075(33))(Utility Platform 工作平台: 1.595(17))(Verandah 陽台: -(-))	-	-	-	-	-	-	55.407 (596)	-	-	-
		B	42.444 (457) (Balcony 露台: 2.975(32))(Utility Platform 工作平台: 1.504(16))(Verandah 陽台: -(-))	-	-	-	-	-	-	35.357 (381)	-	-	-
		C	42.770 (460) (Balcony 露台: 2.975(32))(Utility Platform 工作平台: 1.509(16))(Verandah 陽台: -(-))	-	-	-	-	-	-	34.854 (375)	-	-	-
		D	42.770 (460) (Balcony 露台: 2.975(32))(Utility Platform 工作平台: 1.509(16))(Verandah 陽台: -(-))	-	-	-	-	-	-	34.854 (375)	-	-	-
		E	42.444 (457) (Balcony 露台: 2.975(32))(Utility Platform 工作平台: 1.504(16))(Verandah 陽台: -(-))	-	-	-	-	-	-	35.357 (381)	-	-	-
		F	67.439 (726) (Balcony 露台: 3.075(33))(Utility Platform 工作平台: 1.595(17))(Verandah 陽台: -(-))	-	-	-	-	-	-	55.430 (597)	-	-	-

- Remarks:
- The saleable area of the residential properties is calculated in accordance with Section 8 of the Residential Properties (First-hand Sales) Ordinance.
 - The floor area of each of the balcony, utility platform and verandah, if any, to the extent that it forms part of a residential property, is calculated in accordance with Section 8 of the Residential Properties (First-hand Sales) Ordinance.
 - The areas of other specified items (not included in the saleable area) are calculated in accordance with Part 2 of Schedule 2 to the Residential Properties (First-hand Sales) Ordinance.

- The areas in square feet have been converted from square metres based on a conversion rate of 1 square metre = 10.764 square feet and rounded off to the nearest integer.
- 4/F is omitted.

- 住宅物業的實用面積是按《一手住宅物業銷售條例》第8條計算得出的。
- 在構成住宅物業的一部分的範圍內的每一露台、工作平台及陽台(如有)之樓面面積是按《一手住宅物業銷售條例》第8條計算得出的。
- 其他指明項目的面積(不計算入實用面積)是按《一手住宅物業銷售條例》附表2第2部計算得出的。

備註:

- 以平方呎列出的面積由以平方米列出的面積以1平方米=10.764平方呎換算,並以四捨五入至整數。
- 不設4樓。

Area of residential properties in the development

發展項目中的住宅物業的面積

Description of Residential Property 物業的描述			Saleable Area (including balcony, utility platform and verandah, if any) sq. metre (sq. ft.) 實用面積 (包括露台、工作平台及陽台(如有))平方米(平方呎)	Area of other specified items (Not included in the Saleable Area) sq. metre (sq. ft.) 其他指明項目的面積(不計算入實用面積) 平方米(平方呎)									
Tower Number 座號	Floor 樓層	Flat 單位		Air-conditioning Plant Room 空調機房	Bay Window 窗台	Cockloft 閣樓	Flat Roof 平台	Garden 花園	Parking Space 停車位	Roof 天台	Stairhood 梯屋	Terrace 前庭	Yard 庭院
Tower 25 座	LG/F & G/F (Duplex Unit) 地下低和地下 (複式單位)	A	171.677 (1,848) (Balcony 露台: 5.047(54))(Utility Platform 工作平台: 1.648(18))(Verandah 陽台: (-))	3.264 (35)	-	-	-	53.514 (576)	-	-	-	-	-
		B	162.908 (1,754) (Balcony 露台: 4.988(54))(Utility Platform 工作平台: 1.648(18))(Verandah 陽台: (-))	3.259 (35)	-	-	-	35.181 (379)	-	-	-	-	-
		C	162.908 (1,754) (Balcony 露台: 4.988(54))(Utility Platform 工作平台: 1.648(18))(Verandah 陽台: (-))	3.925 (42)	-	-	-	27.553 (297)	-	-	-	-	-
		D	170.033 (1,830) (Balcony 露台: 3.403(37))(Utility Platform 工作平台: 1.648(18))(Verandah 陽台: (-))	2.755 (30)	-	-	-	42.090 (453)	-	-	-	-	-
	G/F 地下	E	93.770 (1,009) (Balcony 露台: (-))(Utility Platform 工作平台: (-))(Verandah 陽台: (-))	-	-	-	-	20.844 (224)	-	-	-	-	-
		F	93.770 (1,009) (Balcony 露台: (-))(Utility Platform 工作平台: (-))(Verandah 陽台: (-))	-	-	-	-	29.357 (316)	-	-	-	-	-
	1/F 1樓	A	90.854 (978) (Balcony 露台: (-))(Utility Platform 工作平台: (-))(Verandah 陽台: (-))	-	-	-	34.552 (372)	-	-	-	-	-	-
		B	90.854 (978) (Balcony 露台: (-))(Utility Platform 工作平台: (-))(Verandah 陽台: (-))	-	-	-	43.500 (468)	-	-	-	-	-	-
		C	101.913 (1,097) (Balcony 露台: (-))(Utility Platform 工作平台: 2.013(22))(Verandah 陽台: (-))	-	-	-	8.334 (90)	-	-	-	-	-	-
		D	101.913 (1,097) (Balcony 露台: (-))(Utility Platform 工作平台: 2.013(22))(Verandah 陽台: (-))	-	-	-	8.334 (90)	-	-	-	-	-	-
	2/F 2樓	A	99.032 (1,066) (Balcony 露台: 6.675(72))(Utility Platform 工作平台: 1.503(16))(Verandah 陽台: (-))	-	-	-	-	-	-	-	-	-	-
		B	99.032 (1,066) (Balcony 露台: 6.675(72))(Utility Platform 工作平台: 1.503(16))(Verandah 陽台: (-))	-	-	-	-	-	-	-	-	-	-
		C	106.988 (1,152) (Balcony 露台: 5.075(55))(Utility Platform 工作平台: 2.013(22))(Verandah 陽台: (-))	-	-	-	-	-	-	-	-	-	-
		D	106.988 (1,152) (Balcony 露台: 5.075(55))(Utility Platform 工作平台: 2.013(22))(Verandah 陽台: (-))	-	-	-	-	-	-	-	-	-	-
	3/F 3樓	A	99.032 (1,066) (Balcony 露台: 6.675(72))(Utility Platform 工作平台: 1.503(16))(Verandah 陽台: (-))	-	-	-	-	-	-	79.297 (854)	-	-	-
		B	99.032 (1,066) (Balcony 露台: 6.675(72))(Utility Platform 工作平台: 1.503(16))(Verandah 陽台: (-))	-	-	-	-	-	-	78.180 (842)	-	-	-
		C	106.988 (1,152) (Balcony 露台: 5.075(55))(Utility Platform 工作平台: 2.013(22))(Verandah 陽台: (-))	-	-	-	-	-	-	91.340 (983)	-	-	-
		D	106.988 (1,152) (Balcony 露台: 5.075(55))(Utility Platform 工作平台: 2.013(22))(Verandah 陽台: (-))	-	-	-	-	-	-	85.098 (916)	-	-	-

- The saleable area of the residential properties is calculated in accordance with Section 8 of the Residential Properties (First-hand Sales) Ordinance.
- The floor area of each of the balcony, utility platform and verandah, if any, to the extent that it forms part of a residential property, is calculated in accordance with Section 8 of the Residential Properties (First-hand Sales) Ordinance.
- The areas of other specified items (not included in the saleable area) are calculated in accordance with Part 2 of Schedule 2 to the Residential Properties (First-hand Sales) Ordinance.

Remarks:

- The areas in square feet have been converted from square metres based on a conversion rate of 1 square metre = 10.764 square feet and rounded off to the nearest integer.
- 4/F is omitted.

- 住宅物業的實用面積是按《一手住宅物業銷售條例》第8條計算得出的。
- 在構成住宅物業的一部分的範圍內的每一露台、工作平台及陽台(如有)之樓面面積是按《一手住宅物業銷售條例》第8條計算得出的。
- 其他指明項目的面積(不計算入實用面積)是按《一手住宅物業銷售條例》附表2第2部計算得出的。

備註:

- 以平方呎列出的面積由以平方米列出的面積以1平方米=10.764平方呎換算,並以四捨五入至整數。
- 不設4樓。

Area of residential properties in the development

發展項目中的住宅物業的面積

Description of Residential Property 物業的描述			Saleable Area (including balcony, utility platform and verandah, if any) sq. metre (sq. ft.) 實用面積 (包括露台、工作平台及陽台(如有))平方米(平方呎)	Area of other specified items (Not included in the Saleable Area) sq. metre (sq. ft.) 其他指明項目的面積(不計算入實用面積) 平方米(平方呎)									
Block Number 座號	Floor 樓層	Residential Unit 單位		Air-conditioning Plant Room 空調機房	Bay Window 窗台	Cockloft 閣樓	Flat Roof 平台	Garden 花園	Parking Space 停車位	Roof 天台	Stairhood 梯屋	Terrace 前庭	Yard 庭院
Block A 座	LG/F & G/F 地下低層和 地下	G1 (Garden Duplex 1) G1 (花園複式1號)	300.330 (3,233) (Balcony 露台: 6.017(65))(Utility Platform 工作平台: (-))(Verandah 陽台: (-))	3.900 (42)	-	-	-	102.515 (1,103)	-	-	-	-	-
		G2 (Garden Duplex 2) G2 (花園複式2號)	296.234 (3,189) (Balcony 露台: 5.981(64))(Utility Platform 工作平台: (-))(Verandah 陽台: (-))	4.688 (50)	-	-	-	82.866 (892)	-	-	-	-	-
		G3 (Garden Duplex 3) G3 (花園複式3號)	297.273 (3,200) (Balcony 露台: 6.017(65))(Utility Platform 工作平台: (-))(Verandah 陽台: (-))	4.380 (47)	-	-	-	73.198 (788)	-	-	-	-	-
		G5 (Garden Duplex 5) G5 (花園複式5號)	296.501 (3,192) (Balcony 露台: 5.981(64))(Utility Platform 工作平台: (-))(Verandah 陽台: (-))	6.819 (73)	-	-	-	98.931 (1,065)	-	-	-	-	-
	1/F - 3/F 1樓至3樓	P1 (Penthouse Triplex 1) P1 (頂層三複式1號)	313.262 (3,372) (Balcony 露台: 5.945(64))(Utility Platform 工作平台: (-))(Verandah 陽台: (-))	4.616 (50)	-	-	53.820 (579)	-	-	78.387 (844)	-	-	-
		P2 (Penthouse Triplex 2) P2 (頂層三複式2號)	273.831 (2,948) (Balcony 露台: 5.945(64))(Utility Platform 工作平台: (-))(Verandah 陽台: (-))	3.233 (35)	-	-	55.103 (593)	-	-	69.598 (749)	-	-	-
		P3 (Penthouse Triplex 3) P3 (頂層三複式3號)	311.320 (3,351) (Balcony 露台: 5.945(64))(Utility Platform 工作平台: (-))(Verandah 陽台: (-))	4.616 (50)	-	-	53.820 (579)	-	-	78.387 (844)	-	-	-
		P5 (Penthouse Triplex 5) P5 (頂層三複式5號)	274.497 (2,955) (Balcony 露台: 5.945(64))(Utility Platform 工作平台: (-))(Verandah 陽台: (-))	3.233 (35)	-	-	55.096 (593)	-	-	69.598 (749)	-	-	-

- The saleable area of the residential properties is calculated in accordance with Section 8 of the Residential Properties (First-hand Sales) Ordinance.
- The floor area of each of the balcony, utility platform and verandah, if any, to the extent that it forms part of a residential property, is calculated in accordance with Section 8 of the Residential Properties (First-hand Sales) Ordinance.
- The areas of other specified items (not included in the saleable area) are calculated in accordance with Part 2 of Schedule 2 to the Residential Properties (First-hand Sales) Ordinance.

Remark :

The areas in square feet have been converted from square metres based on a conversion rate of 1 square metre = 10.764 square feet and rounded off to the nearest integer.

- 住宅物業的實用面積是按《一手住宅物業銷售條例》第8條計算得出的。
- 在構成住宅物業的一部分的範圍內的每一露台、工作平台及陽台(如有)之樓面面積是按《一手住宅物業銷售條例》第8條計算得出的。
- 其他指明項目的面積(不計算入實用面積)是按《一手住宅物業銷售條例》附表2第2部計算得出的。

備註：

以平方呎列出的面積由以平方米列出的面積以1平方米=10.764平方呎換算，並以四捨五入至整數。

Area of residential properties in the development

發展項目中的住宅物業的面積

Description of Residential Property 物業的描述			Saleable Area (including balcony, utility platform and verandah, if any) sq. metre (sq. ft.) 實用面積 (包括露台、工作平台及陽台(如有))平方米(平方呎)	Area of other specified items (Not included in the Saleable Area) sq. metre (sq. ft.) 其他指明項目的面積(不計算入實用面積) 平方米(平方呎)									
Block Number 座號	Floor 樓層	Residential Unit 單位		Air-conditioning Plant Room 空調機房	Bay Window 窗台	Cockloft 閣樓	Flat Roof 平台	Garden 花園	Parking Space 停車位	Roof 天台	Stairhood 梯屋	Terrace 前庭	Yard 庭院
Block B 座	LG/F & G/F 地下低層和 地下	G1 (Garden Duplex 1) G1 (花園複式1號)	299.007 (3,219) (Balcony 露台: 6.017(65))(Utility Platform 工作平台: (-))(Verandah 陽台: (-))	3.607 (39)	-	-	-	58.525 (630)	-	-	-	-	-
		G2 (Garden Duplex 2) G2 (花園複式2號)	294.878 (3,174) (Balcony 露台: 5.981(64))(Utility Platform 工作平台: (-))(Verandah 陽台: (-))	6.122 (66)	-	-	-	68.430 (737)	-	-	-	-	-
		G3 (Garden Duplex 3) G3 (花園複式3號)	297.370 (3,201) (Balcony 露台: 6.017(65))(Utility Platform 工作平台: (-))(Verandah 陽台: (-))	3.469 (37)	-	-	-	61.627 (663)	-	-	-	-	-
		G5 (Garden Duplex 5) G5 (花園複式5號)	292.008 (3,143) (Balcony 露台: 5.981(64))(Utility Platform 工作平台: (-))(Verandah 陽台: (-))	4.564 (49)	-	-	-	111.569 (1,201)	-	-	-	-	-
	1/F - 3/F 1樓至3樓	P1 (Penthouse Triplex 1) P1 (頂層三複式1號)	313.262 (3,372) (Balcony 露台: 5.945(64))(Utility Platform 工作平台: (-))(Verandah 陽台: (-))	4.616 (50)	-	-	55.651 (599)	-	-	78.387 (844)	-	-	-
		P2 (Penthouse Triplex 2) P2 (頂層三複式2號)	273.681 (2,946) (Balcony 露台: 5.945(64))(Utility Platform 工作平台: (-))(Verandah 陽台: (-))	3.233 (35)	-	-	55.103 (593)	-	-	69.598 (749)	-	-	-
		P3 (Penthouse Triplex 3) P3 (頂層三複式3號)	311.664 (3,355) (Balcony 露台: 5.945(64))(Utility Platform 工作平台: (-))(Verandah 陽台: (-))	4.616 (50)	-	-	53.820 (579)	-	-	78.387 (844)	-	-	-
		P5 (Penthouse Triplex 5) P5 (頂層三複式5號)	274.640 (2,956) (Balcony 露台: 5.945(64))(Utility Platform 工作平台: (-))(Verandah 陽台: (-))	3.233 (35)	-	-	51.184 (551)	-	-	69.598 (749)	-	-	-

- The saleable area of the residential properties is calculated in accordance with Section 8 of the Residential Properties (First-hand Sales) Ordinance.
- The floor area of each of the balcony, utility platform and verandah, if any, to the extent that it forms part of a residential property, is calculated in accordance with Section 8 of the Residential Properties (First-hand Sales) Ordinance.
- The areas of other specified items (not included in the saleable area) are calculated in accordance with Part 2 of Schedule 2 to the Residential Properties (First-hand Sales) Ordinance.

Remark :

The areas in square feet have been converted from square metres based on a conversion rate of 1 square metre = 10.764 square feet and rounded off to the nearest integer.

- 住宅物業的實用面積是按《一手住宅物業銷售條例》第8條計算得出的。
- 在構成住宅物業的一部分的範圍內的每一露台、工作平台及陽台(如有)之樓面面積是按《一手住宅物業銷售條例》第8條計算得出的。
- 其他指明項目的面積(不計算入實用面積)是按《一手住宅物業銷售條例》附表2第2部計算得出的。

備註：

以平方呎列出的面積由以平方米列出的面積以1平方米=10.764平方呎換算，並以四捨五入至整數。

Area of residential properties in the development

發展項目中的住宅物業的面積

Description of Residential Property 物業的描述			Saleable Area (including balcony, utility platform and verandah, if any) sq. metre (sq. ft.) 實用面積 (包括露台、工作平台及陽台(如有))平方米(平方呎)	Area of other specified items (Not included in the Saleable Area) sq. metre (sq. ft.) 其他指明項目的面積(不計算入實用面積) 平方米(平方呎)									
Block Number 座號	Floor 樓層	Residential Unit 單位		Air-conditioning Plant Room 空調機房	Bay Window 窗台	Cockloft 閣樓	Flat Roof 平台	Garden 花園	Parking Space 停車位	Roof 天台	Stairhood 梯屋	Terrace 前庭	Yard 庭院
Block C 座	LG/F & G/F 地下低層和 地下	G1 (Garden Duplex 1) G1 (花園複式1號)	254.199 (2,736) (Balcony 露台: 5.024(54))(Utility Platform 工作平台: 2.350(25))(Verandah 陽台: (-))	3.425 (37)	-	-	-	73.668 (793)	-	-	-	-	-
		G2 (Garden Duplex 2) G2 (花園複式2號)	251.139 (2,703) (Balcony 露台: 4.704(51))(Utility Platform 工作平台: 2.350(25))(Verandah 陽台: (-))	4.563 (49)	-	-	-	49.065 (528)	-	-	-	-	-
		G3 (Garden Duplex 3) G3 (花園複式3號)	250.744 (2,699) (Balcony 露台: 5.024(54))(Utility Platform 工作平台: 2.350(25))(Verandah 陽台: (-))	3.425 (37)	-	-	-	51.044 (549)	-	-	-	-	-
		G5 (Garden Duplex 5) G5 (花園複式5號)	251.139 (2,703) (Balcony 露台: 4.704(51))(Utility Platform 工作平台: 2.350(25))(Verandah 陽台: (-))	3.562 (38)	-	-	-	49.878 (537)	-	-	-	-	-
		G6 (Garden Duplex 6) G6 (花園複式6號)	250.744 (2,699) (Balcony 露台: 5.024(54))(Utility Platform 工作平台: 2.350(25))(Verandah 陽台: (-))	3.900 (42)	-	-	-	41.233 (444)	-	-	-	-	-
		G7 (Garden Duplex 7) G7 (花園複式7號)	254.199 (2,736) (Balcony 露台: 5.024(54))(Utility Platform 工作平台: 2.350(25))(Verandah 陽台: (-))	3.899 (42)	-	-	-	37.951 (409)	-	-	-	-	-
	1/F - 2/F 1樓至2樓	P1 (Penthouse Duplex 1) P1 (頂層複式1號)	209.293 (2,253) (Balcony 露台: 6.067(65))(Utility Platform 工作平台: 3.539(38))(Verandah 陽台: (-))	4.120 (44)	-	-	39.312 (423)	-	-	85.082 (916)	-	-	-
		P2 (Penthouse Duplex 2) P2 (頂層複式2號)	204.936 (2,206) (Balcony 露台: 6.268(67))(Utility Platform 工作平台: 3.539(38))(Verandah 陽台: (-))	4.120 (44)	-	-	29.722 (320)	-	-	85.081 (916)	-	-	-
		P3 (Penthouse Duplex 3) P3 (頂層複式3號)	207.433 (2,233) (Balcony 露台: 6.067(65))(Utility Platform 工作平台: 3.770(41))(Verandah 陽台: (-))	4.120 (44)	-	-	29.721 (320)	-	-	85.080 (916)	-	-	-
		P5 (Penthouse Duplex 5) P5 (頂層複式5號)	207.302 (2,231) (Balcony 露台: 6.268(67))(Utility Platform 工作平台: 3.539(38))(Verandah 陽台: (-))	4.120 (44)	-	-	29.722 (320)	-	-	85.081 (916)	-	-	-
		P6 (Penthouse Duplex 6) P6 (頂層複式6號)	205.047 (2,207) (Balcony 露台: 6.067(65))(Utility Platform 工作平台: 3.772(41))(Verandah 陽台: (-))	4.120 (44)	-	-	29.721 (320)	-	-	85.082 (916)	-	-	-
		P7 (Penthouse Duplex 7) P7 (頂層複式7號)	207.255 (2,231) (Balcony 露台: 6.067(65))(Utility Platform 工作平台: 3.539(38))(Verandah 陽台: (-))	4.120 (44)	-	-	29.722 (320)	-	-	85.081 (916)	-	-	-

- The saleable area of the residential properties is calculated in accordance with Section 8 of the Residential Properties (First-hand Sales) Ordinance.
- The floor area of each of the balcony, utility platform and verandah, if any, to the extent that it forms part of a residential property, is calculated in accordance with Section 8 of the Residential Properties (First-hand Sales) Ordinance.
- The areas of other specified items (not included in the saleable area) are calculated in accordance with Part 2 of Schedule 2 to the Residential Properties (First-hand Sales) Ordinance.

Remark :

The areas in square feet have been converted from square metres based on a conversion rate of 1 square metre = 10.764 square feet and rounded off to the nearest integer.

- 住宅物業的實用面積是按《一手住宅物業銷售條例》第8條計算得出的。
- 在構成住宅物業的一部分的範圍內的每一露台、工作平台及陽台(如有)之樓面面積是按《一手住宅物業銷售條例》第8條計算得出的。
- 其他指明項目的面積(不計算入實用面積)是按《一手住宅物業銷售條例》附表2第2部計算得出的。

備註：

以平方呎列出的面積由以平方米列出的面積以1平方米=10.764平方呎換算，並以四捨五入至整數。

Area of residential properties in the development

發展項目中的住宅物業的面積

Description of Residential Property 物業的描述			Saleable Area (including balcony, utility platform and verandah, if any) sq. metre (sq. ft.) 實用面積 (包括露台、工作平台及陽台(如有))平方米(平方呎)	Area of other specified items (Not included in the Saleable Area) sq. metre (sq. ft.) 其他指明項目的面積(不計算入實用面積) 平方米(平方呎)									
Block Number 座號	Floor 樓層	Residential Unit 單位		Air-conditioning Plant Room 空調機房	Bay Window 窗台	Cockloft 閣樓	Flat Roof 平台	Garden 花園	Parking Space 停車位	Roof 天台	Stairhood 梯屋	Terrace 前庭	Yard 庭院
Block D 座	LG/F & G/F 地下低層和 地下	G1 (Garden Duplex 1) G1 (花園複式1號)	204.847 (2,205) (Balcony 露台: 5.716(62))(Utility Platform 工作平台: (-))(Verandah 陽台: (-))	2.700 (29)	-	-	-	52.796 (568)	-	-	-	-	-
		G2 (Garden Duplex 2) G2 (花園複式2號)	204.446 (2,201) (Balcony 露台: 5.716(62))(Utility Platform 工作平台: (-))(Verandah 陽台: (-))	3.020 (33)	-	-	-	52.366 (564)	-	-	-	-	-
		G3 (Garden Duplex 3) G3 (花園複式3號)	204.446 (2,201) (Balcony 露台: 5.716(62))(Utility Platform 工作平台: (-))(Verandah 陽台: (-))	3.020 (33)	-	-	-	52.366 (564)	-	-	-	-	-
		G5 (Garden Duplex 5) G5 (花園複式5號)	204.446 (2,201) (Balcony 露台: 5.716(62))(Utility Platform 工作平台: (-))(Verandah 陽台: (-))	3.020 (33)	-	-	-	52.366 (564)	-	-	-	-	-
		G6 (Garden Duplex 6) G6 (花園複式6號)	204.446 (2,201) (Balcony 露台: 5.716(62))(Utility Platform 工作平台: (-))(Verandah 陽台: (-))	3.020 (33)	-	-	-	52.366 (564)	-	-	-	-	-
		G7 (Garden Duplex 7) G7 (花園複式7號)	204.446 (2,201) (Balcony 露台: 5.716(62))(Utility Platform 工作平台: (-))(Verandah 陽台: (-))	3.020 (33)	-	-	-	52.366 (564)	-	-	-	-	-
		G8 (Garden Duplex 8) G8 (花園複式8號)	204.446 (2,201) (Balcony 露台: 5.716(62))(Utility Platform 工作平台: (-))(Verandah 陽台: (-))	3.020 (33)	-	-	-	52.366 (564)	-	-	-	-	-
		G9 (Garden Duplex 9) G9 (花園複式9號)	204.446 (2,201) (Balcony 露台: 5.716(62))(Utility Platform 工作平台: (-))(Verandah 陽台: (-))	3.020 (33)	-	-	-	52.366 (564)	-	-	-	-	-
		G10 (Garden Duplex 10) G10 (花園複式10號)	204.446 (2,201) (Balcony 露台: 5.716(62))(Utility Platform 工作平台: (-))(Verandah 陽台: (-))	3.020 (33)	-	-	-	52.366 (564)	-	-	-	-	-
		G11 (Garden Duplex 11) G11 (花園複式11號)	204.446 (2,201) (Balcony 露台: 5.716(62))(Utility Platform 工作平台: (-))(Verandah 陽台: (-))	3.020 (33)	-	-	-	52.366 (564)	-	-	-	-	-
		G12 (Garden Duplex 12) G12 (花園複式12號)	204.446 (2,201) (Balcony 露台: 5.716(62))(Utility Platform 工作平台: (-))(Verandah 陽台: (-))	3.020 (33)	-	-	-	52.366 (564)	-	-	-	-	-
		G15 (Garden Duplex 15) G15 (花園複式15號)	204.446 (2,201) (Balcony 露台: 5.716(62))(Utility Platform 工作平台: (-))(Verandah 陽台: (-))	3.020 (33)	-	-	-	52.366 (564)	-	-	-	-	-
		G16 (Garden Duplex 16) G16 (花園複式16號)	204.446 (2,201) (Balcony 露台: 5.716(62))(Utility Platform 工作平台: (-))(Verandah 陽台: (-))	3.020 (33)	-	-	-	52.366 (564)	-	-	-	-	-
		G17 (Garden Duplex 17) G17 (花園複式17號)	204.847 (2,205) (Balcony 露台: 5.716(62))(Utility Platform 工作平台: (-))(Verandah 陽台: (-))	6.969 (75)	-	-	-	52.801 (568)	-	-	-	-	-

- The saleable area of the residential properties is calculated in accordance with Section 8 of the Residential Properties (First-hand Sales) Ordinance.
- The floor area of each of the balcony, utility platform and verandah, if any, to the extent that it forms part of a residential property, is calculated in accordance with Section 8 of the Residential Properties (First-hand Sales) Ordinance.
- The areas of other specified items (not included in the saleable area) are calculated in accordance with Part 2 of Schedule 2 to the Residential Properties (First-hand Sales) Ordinance.

Remark :

The areas in square feet have been converted from square metres based on a conversion rate of 1 square metre = 10.764 square feet and rounded off to the nearest integer.

- 住宅物業的實用面積是按《一手住宅物業銷售條例》第8條計算得出的。
- 在構成住宅物業的一部分的範圍內的每一露台、工作平台及陽台(如有)之樓面面積是按《一手住宅物業銷售條例》第8條計算得出的。
- 其他指明項目的面積(不計算入實用面積)是按《一手住宅物業銷售條例》附表2第2部計算得出的。

備註：

以平方呎列出的面積由以平方米列出的面積以1平方米=10.764平方呎換算，並以四捨五入至整數。

Area of residential properties in the development

發展項目中的住宅物業的面積

Description of Residential Property 物業的描述			Saleable Area (including balcony, utility platform and verandah, if any) sq. metre (sq. ft.) 實用面積 (包括露台、工作平台及陽台(如有))平方米(平方呎)	Area of other specified items (Not included in the Saleable Area) sq. metre (sq. ft.) 其他指明項目的面積(不計算入實用面積) 平方米(平方呎)									
Block Number 座號	Floor 樓層	Residential Unit 單位		Air-conditioning Plant Room 空調機房	Bay Window 窗台	Cockloft 閣樓	Flat Roof 平台	Garden 花園	Parking Space 停車位	Roof 天台	Stairhood 梯屋	Terrace 前庭	Yard 庭院
Block D 座	1/F - 3/F 1樓至3樓	P1 (Penthouse Triplex 1) P1 (頂層三複式1號)	242.889 (2,614) (Balcony 露台: 2.244(24))(Utility Platform 工作平台: 1.720(19))(Verandah 陽台: (-))	3.395 (37)	-	-	32.407 (349)	-	-	54.427 (586)	-	-	-
		P2 (Penthouse Triplex 2) P2 (頂層三複式2號)	243.276 (2,619) (Balcony 露台: 2.587(28))(Utility Platform 工作平台: 1.610(17))(Verandah 陽台: (-))	3.395 (37)	-	-	32.482 (350)	-	-	59.657 (642)	-	-	-
		P3 (Penthouse Triplex 3) P3 (頂層三複式3號)	243.276 (2,619) (Balcony 露台: 2.587(28))(Utility Platform 工作平台: 1.610(17))(Verandah 陽台: (-))	3.395 (37)	-	-	32.472 (350)	-	-	59.378 (639)	-	-	-
		P5 (Penthouse Triplex 5) P5 (頂層三複式5號)	243.276 (2,619) (Balcony 露台: 2.587(28))(Utility Platform 工作平台: 1.610(17))(Verandah 陽台: (-))	3.395 (37)	-	-	32.482 (350)	-	-	59.657 (642)	-	-	-
		P6 (Penthouse Triplex 6) P6 (頂層三複式6號)	243.276 (2,619) (Balcony 露台: 2.587(28))(Utility Platform 工作平台: 1.610(17))(Verandah 陽台: (-))	3.395 (37)	-	-	32.472 (350)	-	-	59.378 (639)	-	-	-
		P7 (Penthouse Triplex 7) P7 (頂層三複式7號)	243.276 (2,619) (Balcony 露台: 2.587(28))(Utility Platform 工作平台: 1.610(17))(Verandah 陽台: (-))	3.395 (37)	-	-	32.482 (350)	-	-	59.657 (642)	-	-	-
		P8 (Penthouse Triplex 8) P8 (頂層三複式8號)	243.276 (2,619) (Balcony 露台: 2.587(28))(Utility Platform 工作平台: 1.610(17))(Verandah 陽台: (-))	3.395 (37)	-	-	32.472 (350)	-	-	59.378 (639)	-	-	-
		P9 (Penthouse Triplex 9) P9 (頂層三複式9號)	243.276 (2,619) (Balcony 露台: 2.587(28))(Utility Platform 工作平台: 1.610(17))(Verandah 陽台: (-))	3.395 (37)	-	-	32.482 (350)	-	-	59.657 (642)	-	-	-
		P10 (Penthouse Triplex 10) P10 (頂層三複式10號)	243.276 (2,619) (Balcony 露台: 2.587(28))(Utility Platform 工作平台: 1.610(17))(Verandah 陽台: (-))	3.395 (37)	-	-	32.472 (350)	-	-	59.378 (639)	-	-	-
		P11 (Penthouse Triplex 11) P11 (頂層三複式11號)	243.276 (2,619) (Balcony 露台: 2.587(28))(Utility Platform 工作平台: 1.610(17))(Verandah 陽台: (-))	3.395 (37)	-	-	32.482 (350)	-	-	59.657 (642)	-	-	-
		P12 (Penthouse Triplex 12) P12 (頂層三複式12號)	243.276 (2,619) (Balcony 露台: 2.587(28))(Utility Platform 工作平台: 1.610(17))(Verandah 陽台: (-))	3.395 (37)	-	-	32.472 (350)	-	-	59.378 (639)	-	-	-
		P15 (Penthouse Triplex 15) P15 (頂層三複式15號)	243.276 (2,619) (Balcony 露台: 2.587(28))(Utility Platform 工作平台: 1.610(17))(Verandah 陽台: (-))	3.395 (37)	-	-	32.482 (350)	-	-	59.657 (642)	-	-	-
		P16 (Penthouse Triplex 16) P16 (頂層三複式16號)	243.276 (2,619) (Balcony 露台: 2.587(28))(Utility Platform 工作平台: 1.610(17))(Verandah 陽台: (-))	3.395 (37)	-	-	32.472 (350)	-	-	59.378 (639)	-	-	-
		P17 (Penthouse Triplex 17) P17 (頂層三複式17號)	242.889 (2,614) (Balcony 露台: 2.244(24))(Utility Platform 工作平台: 1.720(19))(Verandah 陽台: (-))	3.395 (37)	-	-	32.417 (349)	-	-	54.706 (589)	-	-	-

- The saleable area of the residential properties is calculated in accordance with Section 8 of the Residential Properties (First-hand Sales) Ordinance.
- The floor area of each of the balcony, utility platform and verandah, if any, to the extent that it forms part of a residential property, is calculated in accordance with Section 8 of the Residential Properties (First-hand Sales) Ordinance.
- The areas of other specified items (not included in the saleable area) are calculated in accordance with Part 2 of Schedule 2 to the Residential Properties (First-hand Sales) Ordinance.

Remark :

The areas in square feet have been converted from square metres based on a conversion rate of 1 square metre = 10.764 square feet and rounded off to the nearest integer.

- 住宅物業的實用面積是按《一手住宅物業銷售條例》第8條計算得出的。
- 在構成住宅物業的一部分的範圍內的每一露台、工作平台及陽台(如有)之樓面面積是按《一手住宅物業銷售條例》第8條計算得出的。
- 其他指明項目的面積(不計算入實用面積)是按《一手住宅物業銷售條例》附表2第2部計算得出的。

備註：

以平方呎列出的面積由以平方米列出的面積以1平方米=10.764平方呎換算，並以四捨五入至整數。

Area of residential properties in the development

發展項目中的住宅物業的面積

Description of Residential Property 物業的描述			Saleable Area (including balcony, utility platform and verandah, if any) sq. metre (sq. ft.) 實用面積 (包括露台、工作平台及陽台(如有))平方米(平方呎)	Area of other specified items (Not included in the Saleable Area) sq. metre (sq. ft.) 其他指明項目的面積(不計算入實用面積) 平方米(平方呎)									
Block Number 座號	Floor 樓層	Residential Unit 單位		Air-conditioning Plant Room 空調機房	Bay Window 窗台	Cockloft 閣樓	Flat Roof 平台	Garden 花園	Parking Space 停車位	Roof 天台	Stairhood 梯屋	Terrace 前庭	Yard 庭院
Block E 座	LG/F & G/F 地下低層和 地下	G1 (Garden Duplex 1) G1 (花園複式1號)	218,985 (2,357) (Balcony 露台: 5.716(62))(Utility Platform 工作平台: (-))(Verandah 陽台: (-))	2,925 (31)	-	-	-	40,043 (431)	-	-	-	-	-
		G2 (Garden Duplex 2) G2 (花園複式2號)	215,891 (2,324) (Balcony 露台: 5.716(62))(Utility Platform 工作平台: (-))(Verandah 陽台: (-))	2,813 (30)	-	-	-	39,563 (426)	-	-	-	-	-
		G3 (Garden Duplex 3) G3 (花園複式3號)	215,891 (2,324) (Balcony 露台: 5.716(62))(Utility Platform 工作平台: (-))(Verandah 陽台: (-))	2,813 (30)	-	-	-	39,563 (426)	-	-	-	-	-
		G5 (Garden Duplex 5) G5 (花園複式5號)	215,891 (2,324) (Balcony 露台: 5.716(62))(Utility Platform 工作平台: (-))(Verandah 陽台: (-))	2,813 (30)	-	-	-	39,563 (426)	-	-	-	-	-
		G6 (Garden Duplex 6) G6 (花園複式6號)	215,891 (2,324) (Balcony 露台: 5.716(62))(Utility Platform 工作平台: (-))(Verandah 陽台: (-))	2,813 (30)	-	-	-	39,563 (426)	-	-	-	-	-
		G7 (Garden Duplex 7) G7 (花園複式7號)	218,985 (2,357) (Balcony 露台: 5.716(62))(Utility Platform 工作平台: (-))(Verandah 陽台: (-))	2,813 (30)	-	-	-	63,979 (689)	-	-	-	-	-
		P1 (Penthouse Triplex 1) P1 (頂層三複式1號)	244,967 (2,637) (Balcony 露台: 2.244(24))(Utility Platform 工作平台: 1.720(19))(Verandah 陽台: (-))	3,395 (37)	-	-	34,075 (367)	-	-	58,414 (629)	-	-	-
	P2 (Penthouse Triplex 2) P2 (頂層三複式2號)	241,358 (2,598) (Balcony 露台: 2.244(24))(Utility Platform 工作平台: 1.575(17))(Verandah 陽台: (-))	3,395 (37)	-	-	32,629 (351)	-	-	59,089 (636)	-	-	-	
	P3 (Penthouse Triplex 3) P3 (頂層三複式3號)	241,358 (2,598) (Balcony 露台: 2.244(24))(Utility Platform 工作平台: 1.575(17))(Verandah 陽台: (-))	3,395 (37)	-	-	32,613 (351)	-	-	58,809 (633)	-	-	-	
	P5 (Penthouse Triplex 5) P5 (頂層三複式5號)	241,358 (2,598) (Balcony 露台: 2.244(24))(Utility Platform 工作平台: 1.575(17))(Verandah 陽台: (-))	3,395 (37)	-	-	32,629 (351)	-	-	59,089 (636)	-	-	-	
	P6 (Penthouse Triplex 6) P6 (頂層三複式6號)	241,358 (2,598) (Balcony 露台: 2.244(24))(Utility Platform 工作平台: 1.575(17))(Verandah 陽台: (-))	3,395 (37)	-	-	32,613 (351)	-	-	58,809 (633)	-	-	-	
	P7 (Penthouse Triplex 7) P7 (頂層三複式7號)	244,967 (2,637) (Balcony 露台: 2.244(24))(Utility Platform 工作平台: 1.720(19))(Verandah 陽台: (-))	3,395 (37)	-	-	32,841 (354)	-	-	58,693 (632)	-	-	-	

- The saleable area of the residential properties is calculated in accordance with Section 8 of the Residential Properties (First-hand Sales) Ordinance.
- The floor area of each of the balcony, utility platform and verandah, if any, to the extent that it forms part of a residential property, is calculated in accordance with Section 8 of the Residential Properties (First-hand Sales) Ordinance.
- The areas of other specified items (not included in the saleable area) are calculated in accordance with Part 2 of Schedule 2 to the Residential Properties (First-hand Sales) Ordinance.

Remark :

The areas in square feet have been converted from square metres based on a conversion rate of 1 square metre = 10.764 square feet and rounded off to the nearest integer.

- 住宅物業的實用面積是按《一手住宅物業銷售條例》第8條計算得出的。
- 在構成住宅物業的一部分的範圍內的每一露台、工作平台及陽台(如有)之樓面面積是按《一手住宅物業銷售條例》第8條計算得出的。
- 其他指明項目的面積(不計算入實用面積)是按《一手住宅物業銷售條例》附表2第2部計算得出的。

備註：

以平方呎列出的面積由以平方米列出的面積以1平方米=10.764平方呎換算，並以四捨五入至整數。

Area of residential properties in the development

發展項目中的住宅物業的面積

Description of Residential Property 物業的描述			Saleable Area (including balcony, utility platform and verandah, if any) sq. metre (sq. ft.) 實用面積 (包括露台、工作平台及陽台(如有))平方米(平方呎)	Area of other specified items (Not included in the Saleable Area) sq. metre (sq. ft.) 其他指明項目的面積(不計算入實用面積) 平方米(平方呎)									
Block Number 座號	Floor 樓層	Residential Unit 單位		Air-conditioning Plant Room 空調機房	Bay Window 窗台	Cockloft 閣樓	Flat Roof 平台	Garden 花園	Parking Space 停車位	Roof 天台	Stairhood 梯屋	Terrace 前庭	Yard 庭院
Block F 座	LG/F & G/F 地下低層和 地下	G1 (Garden Duplex 1) G1 (花園複式1號)	218.985 (2,357) (Balcony 露台: 5.716(62))(Utility Platform 工作平台: -(-))(Verandah 陽台: -(-))	2.925 (31)	-	-	-	46.236 (498)	-	-	-	-	-
		G2 (Garden Duplex 2) G2 (花園複式2號)	215.891 (2,324) (Balcony 露台: 5.716(62))(Utility Platform 工作平台: -(-))(Verandah 陽台: -(-))	2.813 (30)	-	-	-	45.755 (493)	-	-	-	-	-
		G3 (Garden Duplex 3) G3 (花園複式3號)	215.891 (2,324) (Balcony 露台: 5.716(62))(Utility Platform 工作平台: -(-))(Verandah 陽台: -(-))	2.813 (30)	-	-	-	45.755 (493)	-	-	-	-	-
		G5 (Garden Duplex 5) G5 (花園複式5號)	218.985 (2,357) (Balcony 露台: 5.716(62))(Utility Platform 工作平台: -(-))(Verandah 陽台: -(-))	2.925 (31)	-	-	-	46.236 (498)	-	-	-	-	-
	1/F - 3/F 1樓至3樓	P1 (Penthouse Triplex 1) P1 (頂層三複式1號)	244.961 (2,637) (Balcony 露台: 2.244(24))(Utility Platform 工作平台: 1.716(18))(Verandah 陽台: -(-))	3.395 (37)	-	-	32.883 (354)	-	-	58.414 (629)	-	-	-
		P2 (Penthouse Triplex 2) P2 (頂層三複式2號)	241.358 (2,598) (Balcony 露台: 2.244(24))(Utility Platform 工作平台: 1.575(17))(Verandah 陽台: -(-))	3.395 (37)	-	-	32.629 (351)	-	-	59.089 (636)	-	-	-
		P3 (Penthouse Triplex 3) P3 (頂層三複式3號)	241.358 (2,598) (Balcony 露台: 2.244(24))(Utility Platform 工作平台: 1.575(17))(Verandah 陽台: -(-))	3.395 (37)	-	-	32.613 (351)	-	-	58.809 (633)	-	-	-
		P5 (Penthouse Triplex 5) P5 (頂層三複式5號)	244.967 (2,637) (Balcony 露台: 2.244(24))(Utility Platform 工作平台: 1.720(19))(Verandah 陽台: -(-))	3.395 (37)	-	-	34.091 (367)	-	-	58.693 (632)	-	-	-

- The saleable area of the residential properties is calculated in accordance with Section 8 of the Residential Properties (First-hand Sales) Ordinance.
- The floor area of each of the balcony, utility platform and verandah, if any, to the extent that it forms part of a residential property, is calculated in accordance with Section 8 of the Residential Properties (First-hand Sales) Ordinance.
- The areas of other specified items (not included in the saleable area) are calculated in accordance with Part 2 of Schedule 2 to the Residential Properties (First-hand Sales) Ordinance.

Remark :

The areas in square feet have been converted from square metres based on a conversion rate of 1 square metre = 10.764 square feet and rounded off to the nearest integer.

- 住宅物業的實用面積是按《一手住宅物業銷售條例》第8條計算得出的。
- 在構成住宅物業的一部分的範圍內的每一露台、工作平台及陽台(如有)之樓面面積是按《一手住宅物業銷售條例》第8條計算得出的。
- 其他指明項目的面積(不計算入實用面積)是按《一手住宅物業銷售條例》附表2第2部計算得出的。

備註：

以平方呎列出的面積由以平方米列出的面積以1平方米=10.764平方呎換算，並以四捨五入至整數。

Floor plans of parking spaces in the development

發展項目中的停車位的樓面平面圖

Ground Floor (Portion I)
地下 (第1部分)



Floor plans of parking spaces in the development

發展項目中的停車位的樓面平面圖

Ground Floor (Portion 2)
地下(第2部分)

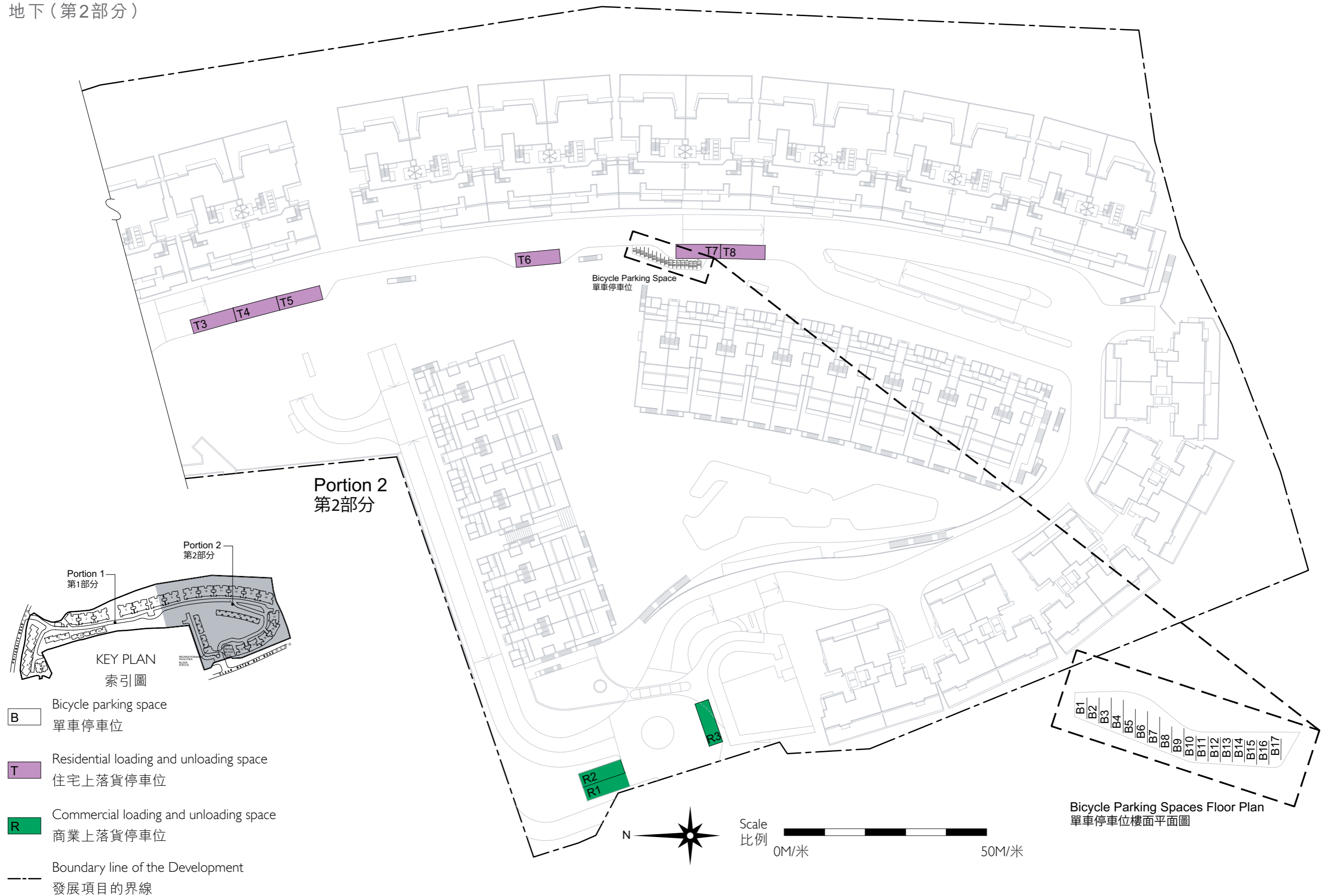

Floor plans of parking spaces in the development

發展項目中的停車位的樓面平面圖

Basement (Zone A & B)
地庫 (A及B區)



Floor plans of parking spaces in the development

發展項目中的停車位的樓面平面圖

Basement (Zone C2)
地庫 (C2區)

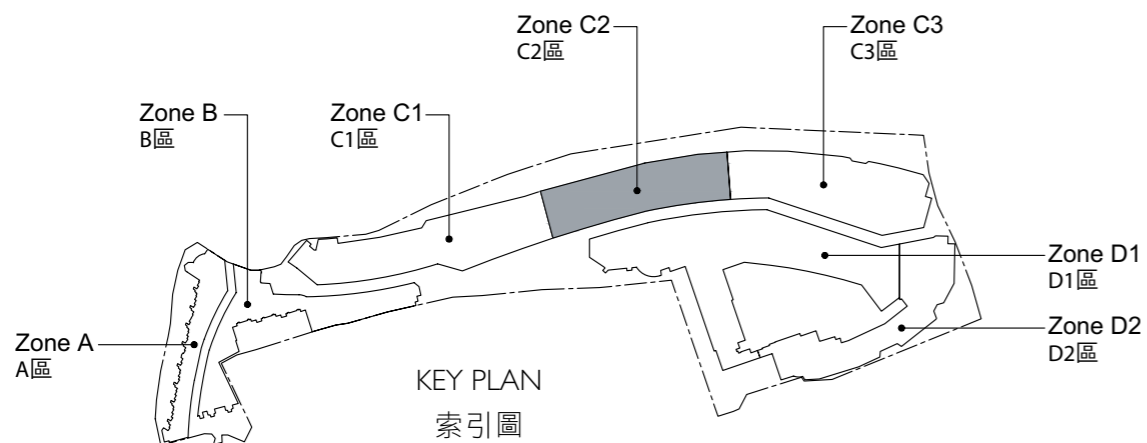

-  Residential parking space
住宅停車位
-  Accessible residential parking space
暢通易達住宅停車位
-  Boundary line of the Development
發展項目的界線

Floor plans of parking spaces in the development

發展項目中的停車位的樓面平面圖

Basement (Zone C3)
地庫 (C3區)

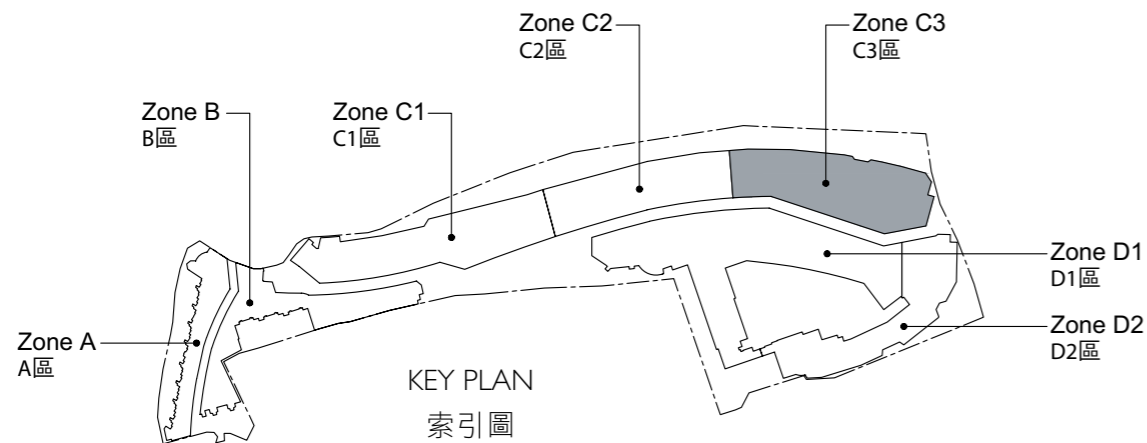
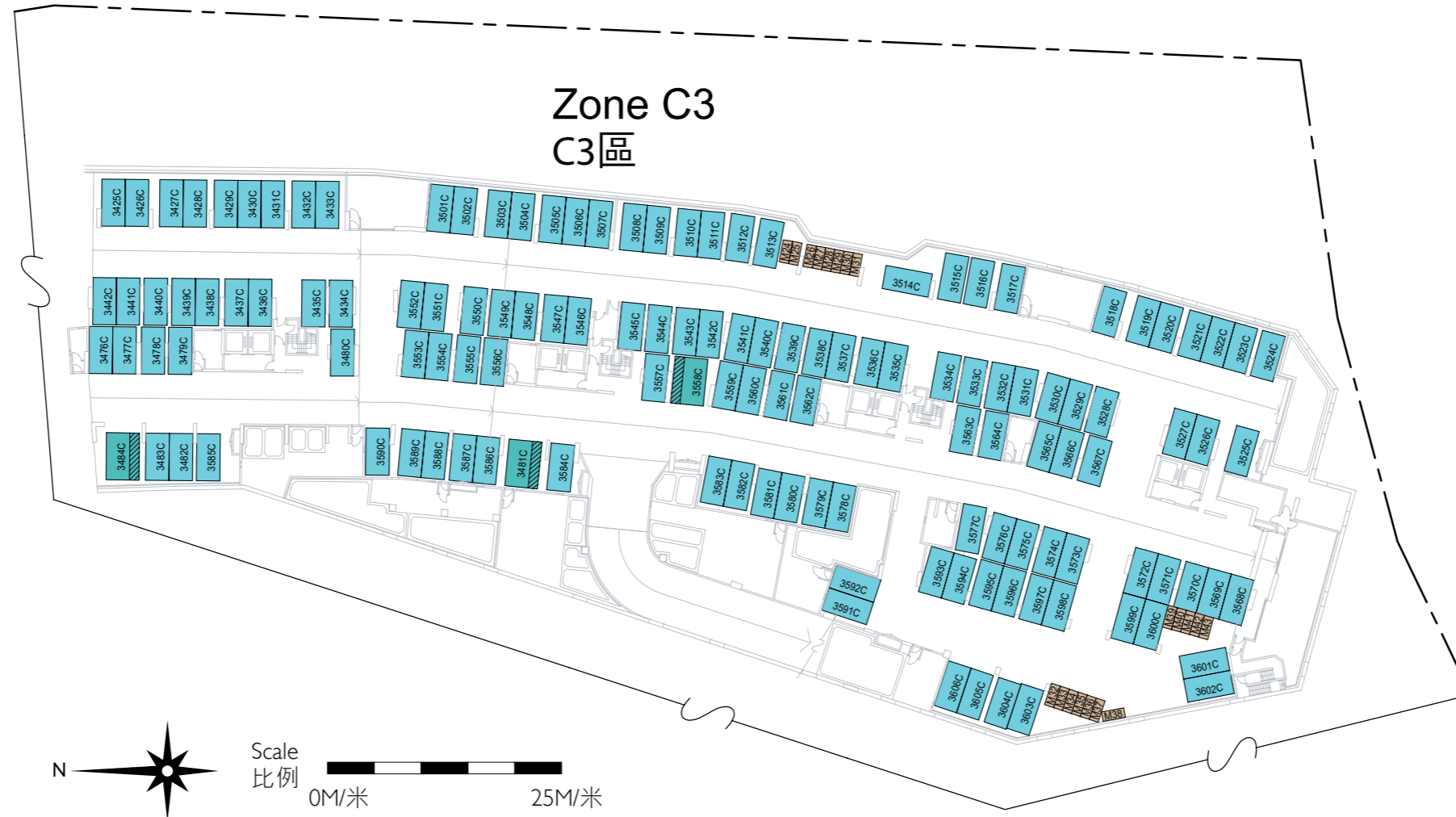

- Residential parking space
住宅停車位
- Accessible residential parking space
暢通易達住宅停車位
- Motor cycle parking space
電單車停車位
- Boundary line of the Development
發展項目的界線

Floor plans of parking spaces in the development

發展項目中的停車位的樓面平面圖

Basement (Zone D1)
地庫 (D1區)

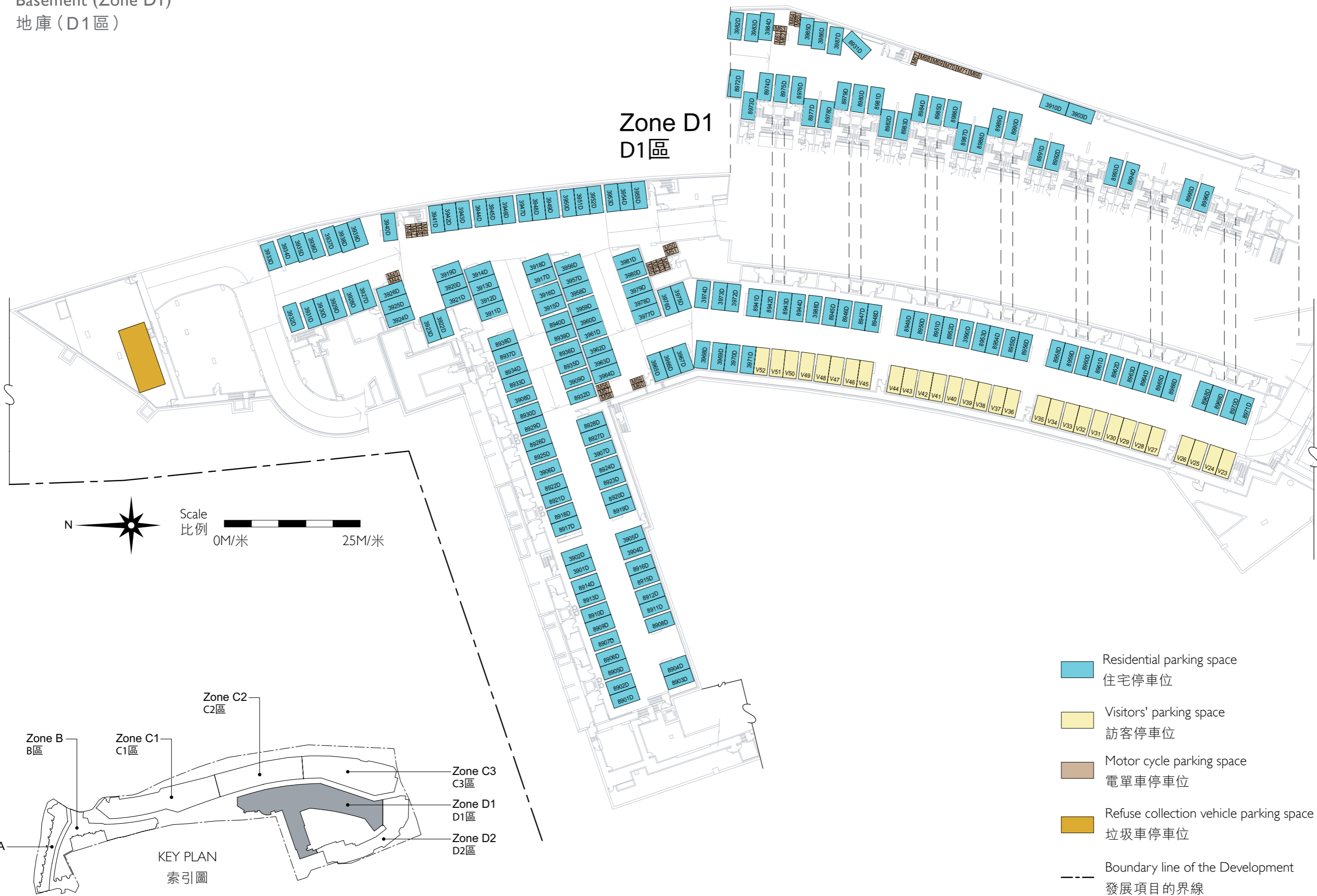

- Residential parking space
住宅停車位
- Visitors' parking space
訪客停車位
- Motor cycle parking space
電單車停車位
- Refuse collection vehicle parking space
垃圾車停車位
- Boundary line of the Development
發展項目的界線

Floor plans of parking spaces in the development

發展項目中的停車位的樓面平面圖

Basement (Zone D2)
地庫 (D2區)



Floor plans of parking spaces in the development

發展項目中的停車位的樓面平面圖

Number, dimensions and areas of parking spaces

停車位的數目、尺寸及面積

Category of parking space 停車位類別	Number 數目		Parking space number 停車位編號	Dimensions (LxW)(m.) 尺寸(長x闊)(米)	Area of each parking space (sq.m.) 每個停車位面積(平方米)
	Ground floor 地下	Basement 地庫			
Residential parking space 住宅停車位	-	718	3101C - 3158C, 3201C - 3295C, 3301C - 3381C, 3401C - 3480C, 3482C - 3483C, 3485C - 3489C, 3491C - 3497C, 3501C - 3557C, 3559C - 3606C, 3701B - 3746B, 3901D - 3988D, 3990D, 8701B - 8724B, 8801A - 8832A, 8901D - 8956D, 8958D - 8966D & 8968D - 8996D	5.0(L) × 2.5(W)	12.5
Accessible residential parking space 暢通易達住宅停車位	-	5	3481C, 3484C, 3490C, 3558C & 3747B	5.0(L) × 3.5(W)	17.5
Visitors' parking space 訪客停車位	-	52	VI - V52	5.0(L) × 2.5(W)	12.5
Commercial parking space 商業停車位	-	51	CI - C14, & C16 - C52	5.0(L) × 2.5(W)	12.5
Accessible commercial parking space 暢通易達商業停車位	-	1	C15	5.0(L) × 3.5(W)	17.5
Motor cycle parking space 電單車停車位	-	76	MI - M76	2.4(L) × 1.0(W)	2.4
Bicycle parking space 單車停車位	17	-	BI - BI7	1.8(L) × 0.5(W)	0.9
Residential loading and unloading space 住宅上落貨停車位	8	-	TI - T8	11.0(L) × 3.5(W)	38.5
Commercial loading and unloading space 商業上落貨停車位	3	-	RI - R3	11.0(L) × 3.5(W)	38.5
Refuse collection vehicle parking space 垃圾車停車位	-	1	-	12.0(L) × 5.0(W)	60.0

Summary of preliminary agreement for sale and purchase

臨時買賣合約的摘要

- | | |
|--|--|
| <p>1. A preliminary deposit of 5% is payable on the signing of the preliminary agreement for sale and purchase.</p> <p>2. The preliminary deposit paid by the purchaser on the signing of that preliminary agreement will be held by a firm of solicitors acting for the owner, as stakeholders.</p> <p>3. If the purchaser fails to execute the agreement for sale and purchase within 5 working days after the date on which the purchaser enters into the preliminary agreement-</p> <p>(i) that preliminary agreement is terminated;</p> <p>(ii) the preliminary deposit is forfeited; and</p> <p>(iii) the owner does not have any further claim against the purchaser for the failure.</p> | <p>1. 在簽署臨時買賣合約時須支付款額為5%的臨時訂金。</p> <p>2. 買方在簽署臨時買賣合約時須支付的臨時訂金，會由代表擁有人行事的律師事務所以保證金保存人的身份持有。</p> <p>3. 如買方沒有於訂立該臨時合約的日期之後的5個工作日內簽立買賣合約-</p> <p>(i) 該臨時合約即告終止；</p> <p>(ii) 有關的臨時訂金即予沒收；及</p> <p>(iii) 擁有人不得就買方沒有簽立買賣合約而針對買方提出進一步申索。</p> |
|--|--|

公契的摘要

A. Common parts of the Development

According to the latest draft Deed of Mutual Covenant and Management Agreement (“DMC”) in respect of the Development:-

“**Common Areas and Facilities**” means:-

- (a) the Development Common Areas and Facilities, the Estate Common Areas and Facilities, the Residential Common Areas and Facilities, the Residential Tower Common Areas and Facilities, the Residential Block Common Areas and Facilities, the Carpark Common Areas and Facilities and (if and when the Sub-Deed in respect of the Commercial Accommodation has been executed) the Commercial Common Areas and Facilities; and
- (b) such other areas and facilities of and in the Land and the Development as are now or may from time to time be designated as Common Areas and Facilities in accordance with the DMC or in any Sub-Deed.

“**Carpark Common Areas and Facilities**” means:-

- (a) the whole of the Carpark (except the Parking Spaces and the Visitor Parking Spaces); and
- (b) emergency generator room, such areas and facilities of and in the Land and the Development for the common use and benefit of the Carpark as a whole

which for the purposes of identification only are shown coloured Light Indigo on the plans annexed to the DMC,

PROVIDED THAT where appropriate, if (i) any parts of the Carpark covered by paragraph (a) of the definition of “common parts” set out in section 2 of the Building Management Ordinance and/or (ii) any parts specified in the Schedule 1 to the Building Management Ordinance and included under paragraph (b) of the definition of “common parts” set out in section 2 of the Building Management Ordinance shall also be covered by the provisions hereinbefore provided, such parts shall be deemed to have been included as, and shall form part of, the Carpark Common Areas and Facilities, but shall exclude the Development Common Areas and Facilities, the Estate Common Areas and Facilities, the Residential Common Areas and Facilities, the Residential Tower Common Areas and Facilities, the Residential Block Common Areas and Facilities and the Commercial Common Areas and Facilities.

“**Commercial Common Areas and Facilities**” means, after the execution of the Sub-Deed in respect of the Commercial Accommodation:-

- (a) the Commercial Loading and Unloading Spaces; and
- (b) such areas and facilities of and in the Land and the Development intended for common use and benefit of the Commercial Accommodation as a whole;

PROVIDED THAT where appropriate, if (i) any parts of the Commercial Accommodation covered by paragraph (a) of the definition of “common parts” set out in section 2 of the Building Management Ordinance and/or (ii) any parts specified in the Schedule 1 to the Building Management Ordinance and included under paragraph (b) of the definition of “common parts” set out in section 2 of the Building Management Ordinance shall also be covered by the provisions hereinbefore provided, such parts shall be deemed to have been included as, and shall form part of, the Commercial Common Areas and Facilities, but shall exclude the Development Common Areas and Facilities, the Estate Common Areas and Facilities, the Residential Common Areas and Facilities, the Residential Tower Common Areas and Facilities, the Residential Block Common Areas and Facilities and the Carpark Common Areas and Facilities.

“**Development Common Areas and Facilities**” means:-

- (a) the Public EVA, the Footpath, the Greenery Areas (in so far as they form part of the Development Common Areas and Facilities), the Drainage Reserve, the Office for Watchmen and Caretakers and the Owners’ Committee Office;
- (b) caretakers’ quarters, corridors, driveway, emergency generator room, emergency vehicular access, fan rooms, fire service control rooms, landings, street fire hydrant pump room, pump rooms, rain storage tank, ramps, refuse storage and material recovery chamber, sewage treatment plant room, staircases, switch rooms, telecommunications and broadcasting equipment rooms, transformer rooms, cable accommodation and all associated facilities, unexcavated areas, master water meter rooms, water meter cabinets, street fire hydrant water tank, sprinkler control valve cabinet, water tanks; and
- (c) such areas and facilities of and in the Land and the Development intended for common use and benefit of the Development as a whole

which for the purposes of identification only are shown coloured Green, Green Hatched Black and Green Cross-Hatched Black on the plans annexed to the DMC,

PROVIDED THAT where appropriate, if (i) any parts of the Development covered by paragraph (a) of the definition of “common parts” set out in section 2 of the Building Management Ordinance and/or (ii) any parts specified in the Schedule 1 to the Building Management Ordinance and included under paragraph (b) of the definition of “common parts” set out in section 2 of the Building Management Ordinance shall also be covered by the provisions hereinbefore provided, such parts shall be deemed to have been included as, and shall form part of, the Development Common Areas and Facilities, but shall exclude the Estate Common Areas and Facilities, the Residential Common Areas and Facilities, the Residential Tower Common Areas and Facilities, the Residential Block Common Areas and Facilities, the Commercial Common Areas and Facilities and the Carpark Common Areas and Facilities;

Summary of deed of mutual covenant

公契的摘要

"Estate Common Areas and Facilities" means:-

- (a) boundary fence wall of the Development, cable lead in, fire service and sprinkler water pump room and water tank serving both Club House and Carpark, driveway, emergency vehicular access, flat roofs and roofs (not forming part of any Unit), ramps, transformer rooms, cable accommodation and all associated facilities, EL switch rooms, switch rooms, sprinkler control valve cabinet, Greenery Areas (in so far as they form part of the Estate Common Areas and Facilities); and
- (b) such areas and facilities of and in the Land and the Development intended for common use and benefit of the Residential Accommodation and the Carpark as a whole which for the purposes of identification only are shown coloured Yellow on the plans annexed to the DMC,

PROVIDED THAT where appropriate, if (i) any parts of the Residential Accommodation and the Carpark covered by paragraph (a) of the definition of "common parts" set out in section 2 of the Building Management Ordinance and/or (ii) any parts specified in the Schedule 1 to the Building Management Ordinance and included under paragraph (b) of the definition of "common parts" set out in section 2 of the Building Management Ordinance shall also be covered by the provisions hereinbefore provided, such parts shall be deemed to have been included as, and shall form part of, the Estate Common Areas and Facilities, but shall exclude the Development Common Areas and Facilities, the Residential Common Areas and Facilities, the Residential Tower Common Areas and Facilities, the Residential Block Common Areas and Facilities, the Commercial Common Areas and Facilities and the Carpark Common Areas and Facilities;

"Residential Block Common Areas and Facilities" means:-

- (a) architectural features, curtain walls (excluding windows forming part of the Residential Units), the Greenery Areas (in so far as they form part of the Residential Block Common Areas and Facilities), external walls (including non-structural prefabricated external walls), flat roofs and roofs (not forming any part of a Residential Unit) of the Residential Blocks, air-conditioning platforms, corridors, electricity meter rooms, water meter cabinet, fire service inlets, landings, lift lobbies, lifts, lift pits, lift shafts, pipe ducts, staircases; and
- (b) such areas and facilities provided in the Land and the Development intended for the common use and benefit of the Residential Blocks as a whole

which for the purposes of identification only are shown coloured Indigo on the plans annexed to the DMC,

PROVIDED THAT where appropriate, if (i) any parts of the Residential Blocks covered by paragraph (a) of the definition of "common parts" set out in section 2 of the Building Management Ordinance and/or (ii) any parts specified in the Schedule 1 to the Building Management Ordinance and included under paragraph (b) of the definition of "common parts" set out in section 2 of the Building Management Ordinance shall also be covered by the provisions hereinbefore provided, such parts shall be deemed to have been included as, and shall form part of, the Residential Block Common Areas and Facilities but shall exclude the Development Common Areas and Facilities, the Estate Common Areas and Facilities, the Residential Common Areas and Facilities, the Residential Tower Common Areas and Facilities, the Commercial Common Areas and Facilities and the Carpark Common Areas and Facilities;

"Residential Common Areas and Facilities" means:-

- (a) the Bicycle Parking Spaces, the Greenery Areas (in so far as they form part of the Residential Common Areas and Facilities), the Guard Booths, the Recreational Facilities, the Residential Loading and Unloading Spaces, the Visitor Parking Spaces and their associated electric vehicle charging facilities;

- (b) covered landscaped area, driveway, electricity meter rooms, emergency vehicular access, filtration plant room for indoor swimming pool, filtration plant room for outdoor and indoor swimming pool, water feature filtration plant rooms, fire service inlets, landings, landscaped areas, lawn, lifts, lift lobbies, lift pits, lift shafts, lift machine rooms, pipe ducts, planters, fire service pump rooms, heat water pump room, potable water pump rooms, potable and flushing water pump rooms, pump rooms, ramps, staircases, switch rooms, vent shafts, walkways, water features, water meter cabinets, water meter rooms, fire service water tanks, flushing water tanks, potable water tanks, water tanks; and
- (c) such areas and facilities of and in the Land and the Development intended for the common use and benefit of the Residential Accommodation as a whole

which for the purposes of identification only are shown coloured Orange on the plans annexed to the DMC,

PROVIDED THAT where appropriate, if (i) any parts of the Residential Accommodation covered by paragraph (a) of the definition of "common parts" set out in section 2 of the Building Management Ordinance and/or (ii) any parts specified in the Schedule 1 to the Building Management Ordinance and included under paragraph (b) of the definition of "common parts" set out in section 2 of the Building Management Ordinance shall also be covered by the provisions hereinbefore provided, such parts shall be deemed to have been included as, and shall form part of, the Residential Common Areas and Facilities, but shall exclude the Development Common Areas and Facilities, the Estate Common Areas and Facilities, the Residential Tower Common Areas and Facilities, the Residential Block Common Areas and Facilities, the Commercial Common Areas and Facilities and the Carpark Common Areas and Facilities;

"Residential Tower Common Areas and Facilities" means:

- (a) architectural features, curtain walls (excluding windows forming part of the Residential Units), the Greenery Areas (in so far as they form part of the Residential Tower Common Areas and Facilities), external walls (including non-structural prefabricated external walls), flat roofs, roofs and upper roofs of the Residential Towers, air-conditioning plant rooms (not forming part of the Residential Units), air-conditioning platforms, air-conditioning units (if any) installed on the roof of the Residential Towers serving the Residential Tower Common Areas and Facilities, air ducts, corridors, dog houses for pipe well vent duct, entrance lobbies, fire service inlets, hose reels, landings, lift pits, lifts, lift shafts, lift lobbies, open pipe well, pipe ducts, refuse storage and material recovery room, staircases, water meter cabinets, electrical meter rooms; and
- (b) such areas and facilities of and in the Land and the Development intended for the common use and benefit of the Residential Towers as a whole

which for the purposes of identification only are shown coloured Red on the plans annexed to the DMC,

PROVIDED THAT where appropriate, if (i) any parts of the Residential Towers covered by paragraph (a) of the definition of "common parts" set out in section 2 of the Building Management Ordinance and/or (ii) any parts specified in the Schedule 1 to the Building Management Ordinance and included under paragraph (b) of the definition of "common parts" set out in section 2 of the Building Management Ordinance shall also be covered by the provisions hereinbefore provided, such parts shall be deemed to have been included as, and shall form part of, the Residential Tower Common Areas and Facilities, but shall exclude the Development Common Areas and Facilities, the Estate Common Areas and Facilities, the Residential Common Areas and Facilities, the Residential Block Common Areas and Facilities, the Commercial Common Areas and Facilities and the Carpark Common Areas and Facilities;

Summary of deed of mutual covenant

公契的摘要

B. Number of undivided shares assigned to each residential property in the Development

I. Residential Blocks

Block	Floor	Residential Unit	Undivided Share	Management Share
A	LG/F & G/F	G1 (Garden Duplex 1)	311	311
	LG/F & G/F	G2 (Garden Duplex 2)	305	305
	LG/F & G/F	G3 (Garden Duplex 3)	305	305
	LG/F & G/F	G5 (Garden Duplex 5)	307	307
	I/F, 2/F & 3/F	P1 (Penthouse Triplex 1)	327	327
	I/F, 2/F & 3/F	P2 (Penthouse Triplex 2)	287	287
	I/F, 2/F & 3/F	P3 (Penthouse Triplex 3)	325	325
	I/F, 2/F & 3/F	P5 (Penthouse Triplex 5)	287	287
		Sub-Total:		2,454

Block	Floor	Residential Unit	Undivided Share	Management Share
B	LG/F & G/F	G1 (Garden Duplex 1)	305	305
	LG/F & G/F	G2 (Garden Duplex 2)	302	302
	LG/F & G/F	G3 (Garden Duplex 3)	304	304
	LG/F & G/F	G5 (Garden Duplex 5)	304	304
	I/F, 2/F & 3/F	P1 (Penthouse Triplex 1)	327	327
	I/F, 2/F & 3/F	P2 (Penthouse Triplex 2)	286	286
	I/F, 2/F & 3/F	P3 (Penthouse Triplex 3)	325	325
	I/F, 2/F & 3/F	P5 (Penthouse Triplex 5)	287	287
		Sub-Total:		2,440

Block	Floor	Residential Unit	Undivided Share	Management Share	
C	LG/F & G/F	G1 (Garden Duplex 1)	262	262	
	LG/F & G/F	G2 (Garden Duplex 2)	257	257	
	LG/F & G/F	G3 (Garden Duplex 3)	256	256	
	LG/F & G/F	G5 (Garden Duplex 5)	256	256	
	LG/F & G/F	G6 (Garden Duplex 6)	255	255	
	LG/F & G/F	G7 (Garden Duplex 7)	258	258	
	I/F & 2/F	P1 (Penthouse Duplex 1)	222	222	
	I/F & 2/F	P2 (Penthouse Duplex 2)	217	217	
	I/F & 2/F	P3 (Penthouse Duplex 3)	219	219	
	I/F & 2/F	P5 (Penthouse Duplex 5)	219	219	
	I/F & 2/F	P6 (Penthouse Duplex 6)	217	217	
	I/F & 2/F	P7 (Penthouse Duplex 7)	219	219	
		Sub-Total:		2,857	2,857

Summary of deed of mutual covenant

公契的摘要

Block	Floor	Residential Unit	Undivided Share	Management Share
D	LG/F & G/F	G1 (Garden Duplex 1)	210	210
	LG/F & G/F	G2 (Garden Duplex 2)	210	210
	LG/F & G/F	G3 (Garden Duplex 3)	210	210
	LG/F & G/F	G5 (Garden Duplex 5)	210	210
	LG/F & G/F	G6 (Garden Duplex 6)	210	210
	LG/F & G/F	G7 (Garden Duplex 7)	210	210
	LG/F & G/F	G8 (Garden Duplex 8)	210	210
	LG/F & G/F	G9 (Garden Duplex 9)	210	210
	LG/F & G/F	G10 (Garden Duplex 10)	210	210
	LG/F & G/F	G11 (Garden Duplex 11)	210	210
	LG/F & G/F	G12 (Garden Duplex 12)	210	210
	LG/F & G/F	G15 (Garden Duplex 15)	210	210
	LG/F & G/F	G16 (Garden Duplex 16)	210	210
	LG/F & G/F	G17 (Garden Duplex 17)	211	211

Block	Floor	Residential Unit	Undivided Share	Management Share	
D	I/F, 2/F & 3/F	P1 (Penthouse Triplex 1)	252	252	
	I/F, 2/F & 3/F	P2 (Penthouse Triplex 2)	253	253	
	I/F, 2/F & 3/F	P3 (Penthouse Triplex 3)	253	253	
	I/F, 2/F & 3/F	P5 (Penthouse Triplex 5)	253	253	
	I/F, 2/F & 3/F	P6 (Penthouse Triplex 6)	253	253	
	I/F, 2/F & 3/F	P7 (Penthouse Triplex 7)	253	253	
	I/F, 2/F & 3/F	P8 (Penthouse Triplex 8)	253	253	
	I/F, 2/F & 3/F	P9 (Penthouse Triplex 9)	253	253	
	I/F, 2/F & 3/F	P10 (Penthouse Triplex 10)	253	253	
	I/F, 2/F & 3/F	P11 (Penthouse Triplex 11)	253	253	
	I/F, 2/F & 3/F	P12 (Penthouse Triplex 12)	253	253	
	I/F, 2/F & 3/F	P15 (Penthouse Triplex 15)	253	253	
	I/F, 2/F & 3/F	P16 (Penthouse Triplex 16)	253	253	
	I/F, 2/F & 3/F	P17 (Penthouse Triplex 17)	252	252	
		Sub-Total:		6,481	6,481

Block	Floor	Residential Unit	Undivided Share	Management Share	
E	LG/F & G/F	G1 (Garden Duplex 1)	223	223	
	LG/F & G/F	G2 (Garden Duplex 2)	220	220	
	LG/F & G/F	G3 (Garden Duplex 3)	220	220	
	LG/F & G/F	G5 (Garden Duplex 5)	220	220	
	LG/F & G/F	G6 (Garden Duplex 6)	220	220	
	LG/F & G/F	G7 (Garden Duplex 7)	226	226	
	I/F, 2/F & 3/F	P1 (Penthouse Triplex 1)	255	255	
	I/F, 2/F & 3/F	P2 (Penthouse Triplex 2)	251	251	
	I/F, 2/F & 3/F	P3 (Penthouse Triplex 3)	251	251	
	I/F, 2/F & 3/F	P5 (Penthouse Triplex 5)	251	251	
	I/F, 2/F & 3/F	P6 (Penthouse Triplex 6)	251	251	
	I/F, 2/F & 3/F	P7 (Penthouse Triplex 7)	254	254	
		Sub-Total:		2,842	2,842

Block	Floor	Residential Unit	Undivided Share	Management Share
F	LG/F & G/F	G1 (Garden Duplex 1)	224	224
	LG/F & G/F	G2 (Garden Duplex 2)	221	221
	LG/F & G/F	G3 (Garden Duplex 3)	221	221
	LG/F & G/F	G5 (Garden Duplex 5)	224	224
	I/F, 2/F & 3/F	P1 (Penthouse Triplex 1)	254	254
	I/F, 2/F & 3/F	P2 (Penthouse Triplex 2)	251	251
	I/F, 2/F & 3/F	P3 (Penthouse Triplex 3)	251	251
	I/F, 2/F & 3/F	P5 (Penthouse Triplex 5)	255	255
		Sub-Total:		1,901

Summary of deed of mutual covenant

公契的摘要

2. Residential Towers

Tower	Floor	Flat	Undivided Share	Management Share	
1	G/F	A	172	172	
		B	148	148	
		C	112	112	
		D	39	39	
	1/F	A	181	181	
		B	149	149	
		C	101	101	
		D	88	88	
	2/F	A	181	181	
		B	149	149	
		C	105	105	
	3/F	A	181	181	
		B	149	149	
		C	105	105	
	5/F	D	91	91	
		A	181	181	
		B	149	149	
		C	105	105	
	6/F	D	91	91	
		A	181	181	
		B	149	149	
		C	105	105	
	7/F	D	91	91	
		A	192	192	
		B	161	161	
		C	107	107	
			D	97	97
			Sub-Total:	3,651	3,651

Tower	Floor	Flat	Undivided Share	Management Share	
2	G/F	A	169	169	
		B	166	166	
		C	126	126	
		D	161	161	
	1/F	A	170	170	
		B	170	170	
		C	103	103	
		D	106	106	
		E	84	84	
	2/F	A	170	170	
		B	170	170	
		C	106	106	
		D	109	109	
		E	90	90	
	3/F	A	170	170	
		B	170	170	
		C	106	106	
		D	109	109	
		E	90	90	
	5/F	A	170	170	
		B	170	170	
		C	106	106	
		D	109	109	
		E	90	90	
	6/F	A	170	170	
		B	170	170	
		C	106	106	
		D	109	109	
		E	90	90	
	7/F	A	184	184	
		B	186	186	
		C	151	151	
		D	149	149	
			Sub-Total:	4,505	4,505

Tower	Floor	Flat	Undivided Share	Management Share	
3	G/F	A	169	169	
		B	179	179	
		C	126	126	
		D	160	160	
	1/F	A	170	170	
		B	177	177	
		C	102	102	
		D	106	106	
		E	84	84	
	2/F	A	170	170	
		B	177	177	
		C	109	109	
		D	109	109	
		E	90	90	
	3/F	A	170	170	
		B	177	177	
		C	109	109	
		D	109	109	
		E	90	90	
	5/F	A	170	170	
		B	177	177	
		C	109	109	
		D	109	109	
		E	90	90	
	6/F	A	170	170	
		B	177	177	
		C	109	109	
		D	109	109	
		E	90	90	
	7/F	A	183	183	
		B	190	190	
		C	158	158	
		D	149	149	
			Sub-Total:	4,573	4,573

Remark : There is no 4/F in the Residential Towers and there is no Tower 4, Tower 13, Tower 14 and Tower 24.

Summary of deed of mutual covenant

公契的摘要

Tower	Floor	Flat	Undivided Share	Management Share
5	G/F	A	182	182
		B	171	171
		C	165	165
		D	127	127
	1/F	A	177	177
		B	171	171
		C	106	106
		D	102	102
		E	84	84
	2/F	A	177	177
		B	171	171
		C	109	109
		D	109	109
		E	90	90
	3/F	A	177	177
		B	171	171
		C	109	109
		D	109	109
		E	90	90
	5/F	A	177	177
		B	171	171
		C	109	109
		D	109	109
		E	90	90
	6/F	A	177	177
		B	171	171
		C	109	109
		D	109	109
E		90	90	
7/F	A	190	190	
	B	183	183	
	C	149	149	
	D	158	158	
	Sub-Total:		4,589	4,589

Tower	Floor	Flat	Undivided Share	Management Share
6	G/F	A	171	171
		B	171	171
		C	129	129
		D	166	166
	1/F	A	171	171
		B	171	171
		C	103	103
		D	106	106
		E	84	84
	2/F	A	171	171
		B	171	171
		C	106	106
		D	109	109
		E	90	90
	3/F	A	171	171
		B	171	171
		C	106	106
		D	109	109
		E	90	90
	5/F	A	171	171
		B	171	171
		C	106	106
		D	109	109
		E	90	90
	6/F	A	171	171
		B	171	171
		C	106	106
		D	109	109
E		90	90	
7/F	A	184	184	
	B	186	186	
	C	151	151	
	D	149	149	
	Sub-Total:		4,530	4,530

Tower	Floor	Flat	Undivided Share	Management Share
7	G/F	A	171	171
		B	171	171
		C	127	127
		D	163	163
	1/F	A	171	171
		B	171	171
		C	103	103
		D	106	106
		E	84	84
	2/F	A	171	171
		B	171	171
		C	106	106
		D	109	109
		E	90	90
	3/F	A	171	171
		B	171	171
		C	106	106
		D	109	109
		E	90	90
	5/F	A	171	171
		B	171	171
		C	106	106
		D	109	109
		E	90	90
	6/F	A	171	171
		B	171	171
		C	106	106
		D	109	109
E		90	90	
7/F	A	184	184	
	B	186	186	
	C	151	151	
	D	149	149	
	Sub-Total:		4,525	4,525

Remark : There is no 4/F in the Residential Towers and there is no Tower 4, Tower 13, Tower 14 and Tower 24.

Summary of deed of mutual covenant

公契的摘要

Tower	Floor	Flat	Undivided Share	Management Share
8	G/F	A	171	171
		B	171	171
		C	127	127
		D	161	161
	1/F	A	171	171
		B	171	171
		C	104	104
		D	106	106
		E	84	84
	2/F	A	171	171
		B	171	171
		C	107	107
		D	109	109
		E	90	90
	3/F	A	171	171
		B	171	171
		C	107	107
		D	109	109
		E	90	90
	5/F	A	171	171
		B	171	171
		C	107	107
		D	109	109
		E	90	90
	6/F	A	171	171
		B	171	171
		C	107	107
		D	109	109
E		90	90	
7/F	A	184	184	
	B	186	186	
	C	151	151	
	D	149	149	
	Sub-Total:		4,528	4,528

Tower	Floor	Flat	Undivided Share	Management Share
9	G/F	A	171	171
		B	171	171
		C	129	129
		D	162	162
	1/F	A	171	171
		B	171	171
		C	105	105
		D	106	106
		E	84	84
	2/F	A	171	171
		B	171	171
		C	108	108
		D	109	109
		E	90	90
	3/F	A	171	171
		B	171	171
		C	108	108
		D	109	109
		E	90	90
	5/F	A	171	171
		B	171	171
		C	108	108
		D	109	109
		E	90	90
	6/F	A	171	171
		B	171	171
		C	108	108
		D	109	109
E		90	90	
7/F	A	184	184	
	B	186	186	
	C	152	152	
	D	149	149	
	Sub-Total:		4,537	4,537

Tower	Floor	Flat	Undivided Share	Management Share
10	G/F	A	171	171
		B	171	171
		C	128	128
		D	163	163
	1/F	A	171	171
		B	171	171
		C	105	105
		D	107	107
		E	84	84
	2/F	A	171	171
		B	171	171
		C	108	108
		D	110	110
		E	90	90
	3/F	A	171	171
		B	171	171
		C	108	108
		D	110	110
		E	90	90
	5/F	A	171	171
		B	171	171
		C	108	108
		D	110	110
		E	90	90
	6/F	A	171	171
		B	171	171
		C	108	108
		D	110	110
E		90	90	
7/F	A	184	184	
	B	186	186	
	C	152	152	
	D	150	150	
	Sub-Total:		4,543	4,543

Remark : There is no 4/F in the Residential Towers and there is no Tower 4, Tower 13, Tower 14 and Tower 24.

Summary of deed of mutual covenant

公契的摘要

Tower	Floor	Flat	Undivided Share	Management Share
11	G/F	A	171	171
		B	171	171
		C	128	128
		D	162	162
	1/F	A	171	171
		B	171	171
		C	105	105
		D	107	107
		E	84	84
	2/F	A	171	171
		B	171	171
		C	108	108
		D	110	110
		E	90	90
	3/F	A	171	171
		B	171	171
		C	108	108
		D	110	110
		E	90	90
	5/F	A	171	171
		B	171	171
		C	108	108
		D	110	110
		E	90	90
	6/F	A	171	171
		B	171	171
		C	108	108
		D	110	110
E		90	90	
7/F	A	184	184	
	B	186	186	
	C	152	152	
	D	150	150	
	Sub-Total:		4,542	4,542

Tower	Floor	Flat	Undivided Share	Management Share
12	G/F	A	171	171
		B	171	171
		C	127	127
		D	162	162
	1/F	A	171	171
		B	171	171
		C	105	105
		D	107	107
		E	84	84
	2/F	A	171	171
		B	171	171
		C	108	108
		D	110	110
		E	90	90
	3/F	A	171	171
		B	171	171
		C	108	108
		D	110	110
		E	90	90
	5/F	A	171	171
		B	171	171
		C	108	108
		D	110	110
		E	90	90
	6/F	A	171	171
		B	171	171
		C	108	108
		D	110	110
E		90	90	
7/F	A	184	184	
	B	186	186	
	C	152	152	
	D	150	150	
	Sub-Total:		4,541	4,541

Tower	Floor	Flat	Undivided Share	Management Share
15	G/F	A	171	171
		B	171	171
		C	128	128
		D	161	161
	1/F	A	171	171
		B	171	171
		C	105	105
		D	107	107
		E	84	84
	2/F	A	171	171
		B	171	171
		C	108	108
		D	110	110
		E	90	90
	3/F	A	171	171
		B	171	171
		C	108	108
		D	110	110
		E	90	90
	5/F	A	171	171
		B	171	171
		C	108	108
		D	110	110
		E	90	90
	6/F	A	171	171
		B	171	171
		C	108	108
		D	110	110
E		90	90	
7/F	A	184	184	
	B	186	186	
	C	152	152	
	D	150	150	
	Sub-Total:		4,541	4,541

Remark : There is no 4/F in the Residential Towers and there is no Tower 4, Tower 13, Tower 14 and Tower 24.

Summary of deed of mutual covenant

公契的摘要

Tower	Floor	Flat	Undivided Share	Management Share
16	G/F	A	171	171
		B	157	157
		C	158	158
		D	162	162
	1/F	A	171	171
		B	159	159
		C	130	130
		D	107	107
		E	84	84
	2/F	A	171	171
		B	159	159
		C	133	133
		D	110	110
		E	90	90
	3/F	A	171	171
		B	159	159
		C	133	133
		D	110	110
		E	90	90
	5/F	A	171	171
		B	159	159
		C	133	133
		D	110	110
		E	90	90
	6/F	A	171	171
		B	159	159
		C	133	133
		D	110	110
E		90	90	
7/F	A	184	184	
	B	174	174	
	C	183	183	
	D	150	150	
	Sub-Total:		4,642	4,642

Tower	Floor	Flat	Undivided Share	Management Share
17	G/F	A	114	114
		B	104	104
		C	85	85
		D	95	95
	1/F	A	121	121
		B	113	113
		C	81	81
		D	91	91
	2/F	A	121	121
		B	113	113
		C	84	84
		D	94	94
	3/F	A	121	121
		B	113	113
		C	84	84
		D	94	94
	5/F	A	121	121
		B	113	113
		C	84	84
		D	94	94
6/F	A	131	131	
	B	122	122	
	C	91	91	
	D	103	103	
	Sub-Total:		2,487	2,487

Tower	Floor	Flat	Undivided Share	Management Share
18	G/F	A	107	107
		B	108	108
		C	85	85
		D	85	85
	1/F	A	108	108
		B	108	108
		C	81	81
		D	81	81
	2/F	A	108	108
		B	108	108
		C	84	84
		D	84	84
	3/F	A	108	108
		B	108	108
		C	84	84
		D	84	84
	5/F	A	108	108
		B	108	108
		C	84	84
		D	84	84
6/F	A	117	117	
	B	117	117	
	C	91	91	
	D	91	91	
	Sub-Total:		2,331	2,331

Remark : There is no 4/F in the Residential Towers and there is no Tower 4, Tower 13, Tower 14 and Tower 24.

Summary of deed of mutual covenant

公契的摘要

Tower	Floor	Flat	Undivided Share	Management Share
19	G/F	A	108	108
		B	105	105
		C	85	85
		D	85	85
	1/F	A	108	108
		B	108	108
		C	81	81
		D	81	81
	2/F	A	108	108
		B	108	108
		C	84	84
		D	84	84
	3/F	A	108	108
		B	108	108
		C	84	84
		D	84	84
	5/F	A	108	108
		B	108	108
		C	84	84
		D	84	84
6/F	A	117	117	
	B	117	117	
	C	91	91	
	D	91	91	
		Sub-Total:	2,329	2,329

Tower	Floor	Flat	Undivided Share	Management Share
20	G/F	A	105	105
		B	108	108
		C	85	85
		D	85	85
	1/F	A	108	108
		B	108	108
		C	81	81
		D	81	81
	2/F	A	108	108
		B	108	108
		C	84	84
		D	84	84
	3/F	A	108	108
		B	108	108
		C	84	84
		D	84	84
	5/F	A	108	108
		B	108	108
		C	84	84
		D	84	84
6/F	A	117	117	
	B	117	117	
	C	91	91	
	D	91	91	
		Sub-Total:	2,329	2,329

Tower	Floor	Flat	Undivided Share	Management Share
21	G/F	A	108	108
		B	105	105
		C	85	85
		D	85	85
	1/F	A	108	108
		B	108	108
		C	81	81
		D	81	81
	2/F	A	108	108
		B	108	108
		C	84	84
		D	84	84
	3/F	A	108	108
		B	108	108
		C	84	84
		D	84	84
	5/F	A	108	108
		B	108	108
		C	84	84
		D	84	84
6/F	A	117	117	
	B	117	117	
	C	91	91	
	D	91	91	
		Sub-Total:	2,329	2,329

Remark : There is no 4/F in the Residential Towers and there is no Tower 4, Tower 13, Tower 14 and Tower 24.

Summary of deed of mutual covenant

公契的摘要

Tower	Floor	Flat	Undivided Share	Management Share
22	G/F	A	102	102
		B	66	66
		C	40	40
		D	65	65
	1/F	A	109	109
		B	44	44
		C	43	43
		D	42	42
		E	67	67
	2/F	A	109	109
		B	44	44
		C	43	43
		D	42	42
		E	67	67
	3/F	A	118	118
		B	47	47
		C	46	46
D		46	46	
E		73	73	
	Sub-Total:		1,213	1,213

Tower	Floor	Flat	Undivided Share	Management Share
23	G/F	A	65	65
		B	40	40
		C	66	66
		D	40	40
		E	65	65
	1/F	A	67	67
		B	42	42
		C	43	43
		D	43	43
		E	42	42
		F	67	67
	2/F	A	67	67
		B	42	42
		C	43	43
		D	43	43
		E	42	42
		F	67	67
	3/F	A	73	73
		B	46	46
		C	46	46
		D	46	46
		E	46	46
		F	73	73
		Sub-Total:		1,214

Tower	Floor	Flat	Undivided Share	Management Share
25	LG/F & G/F	A	177	177
		B	167	167
		C	166	166
		D	175	175
	G/F	E	96	96
		F	97	97
	1/F	A	94	94
		B	95	95
		C	103	103
		D	103	103
	2/F	A	99	99
		B	99	99
		C	107	107
		D	107	107
	3/F	A	107	107
		B	107	107
		C	116	116
D		115	115	
	Sub-Total:		2,130	2,130

Remark : There is no 4/F in the Residential Towers and there is no Tower 4, Tower 13, Tower 14 and Tower 24.

公契的摘要

C. Terms of years for which the manager of the Development is appointed

The manager for the Development shall be appointed for an initial term of not exceeding two (2) years commencing from the date of the DMC and to be continued thereafter unless and until terminated by not less than three (3) calendar months' notice in writing in accordance with the terms of the DMC.

D. Basis on which the management expenses are shared among the owners of the residential properties in the Development

- (a) Each Owner of a Unit shall contribute his due proportion of the budgeted Management Expenses under the first part of the annual budget (which covers all expenditure for the benefit of all Owners or required for the proper management of the Land and the Development, the Development Common Areas and Facilities, the Green Area, the Green Area Structures, the Green Hatched Black Area and the Brown Areas) which proportion shall be equal to the Management Shares of his Unit divided by the total Management Shares of the Development.
- (b) Each Owner of a Residential Unit or a Parking Space shall contribute his due proportion of the budgeted Management Expenses under the second part of the annual budget (which covers all expenditure for the Estate Common Areas and Facilities) which proportion shall be equal to the Management Shares of such Unit owned by him divided by the total Management Shares of all Residential Units and Parking Spaces.
- (c) Each Owner of a Residential Unit shall contribute his due proportion of the budgeted Management Expenses under the third part of the annual budget (which covers all expenditure for the Residential Common Areas and Facilities) which proportion shall be equal to the Management Shares of his Residential Unit divided by the total Management Shares of all Residential Units.
- (d) Each Owner of a Garden Duplex, a Penthouse Duplex or a Penthouse Triplex shall contribute his due proportion of the budgeted Management Expenses under the fourth part of the annual budget (which covers all expenditure for the Residential Block Common Areas and Facilities) which proportion shall be equal to the Management Shares of such Unit owned by him divided by the total Management Shares of all Garden Duplexes, Penthouse Duplexes and Penthouse Triplexes.
- (e) Each Owner of a Flat shall contribute his due proportion of the budgeted Management Expenses under the fifth part of the annual budget (which covers all expenditure for the Residential Tower Common Areas and Facilities) which proportion shall be equal to the Management Shares of his Flat divided by the total Management Shares of all Flats.
- (f) The Owners of the Residential Units shall contribute 6.16% of the budgeted Management Expenses under the sixth part of the annual budget (which covers all expenditure for the Carpark Common Areas and Facilities), to the intent that the due proportion of contribution thereto paid by each Owner of a Residential Unit shall be equal to the Management Shares of his Residential Unit divided by the total Management Shares of all Residential Units.

E. Basis on which the management fee deposit is fixed

A sum as security equivalent to two (2) months' monthly management contribution and such security amount shall be non-refundable but transferable.

F. The area in the Development retained by the Vendor for the Vendor's own use

Not applicable.

Note :

For full details, please refer to the DMC which is free for inspection during opening hours at the sales office. Full script of the DMC is available for inspection upon request and copies of the DMC can be obtained upon paying necessary photocopying charges.

公契的摘要

A. 「發展項目」的公用部份

根據「發展項目」公契及管理協議的最新定稿：

「公用地方與設施」指：

- (a) 「發展項目公用地方與設施」、「屋苑公用地方與設施」、「住宅公用地方與設施」、「住宅大廈公用地方與設施」、「住宅大樓公用地方與設施」、「停車場公用地方與設施」及(於「商業樓宇」訂立「副公契」後)「商業公用地方與設施」；及
- (b) 「該土地」及「發展項目」內現時或不時依照「本契約」或任何「副公契」指定為「公用地方與設施」的地方與設施；

「停車場公用地方與設施」指：

- (a) 「停車場」整體(「停車位」及「訪客停車位」除外)；及
- (b) 緊急發電機房、「該土地」及「發展項目」內供「停車場」整體公用與共享的地方及設施，

現於公契所附圖則以靛藍色顯示，以資識別。

於適當情況下，倘(i)「停車場」任何部分符合「建築物管理條例」第2條中「公用部分」第(a)段的釋義及/或(ii)「停車場」任何部分乃「建築物管理條例」附表1訂明而符合「建築物管理條例」第2條中「公用部分」第(b)段的釋義，此等部分將受制於前述之規定，並且視作屬於「停車場公用地方與設施」的一部分。

然而，「停車場公用地方與設施」並不包括「發展項目公用地方與設施」、「屋苑公用地方與設施」、「住宅公用地方與設施」、「住宅大廈公用地方與設施」、「住宅大樓公用地方與設施」及「商業公用地方與設施」；

「商業公用地方與設施」於「商業樓宇」訂立「副公契」後指：

- (a) 「商業客貨上落車位」；及
- (b) 「該土地」及「發展項目」內供「商業樓宇」整體公用與共享的地方及設施，

然而，只要情況適當，倘：(i)「商業樓宇」任何部分符合「建築物管理條例」第2條中「公用部分」第(a)段的釋義及/或(ii)「商業樓宇」任何部分乃「建築物管理條例」附表1訂明而符合「建築物管理條例」第2條中「公用部分」第(b)段的釋義，此等部分將受制於前述之規定，並且視作屬於「商業公用地方與設施」的一部分。

「商業公用地方與設施」並不包括「發展項目公用地方與設施」、「屋苑公用地方與設施」、「住宅公用地方與設施」、「住宅大廈公用地方與設施」、「住宅大樓公用地方與設施」及「停車場公用地方與設施」；

「發展項目公用地方與設施」指：

- (a) 「公共緊急車輛通道」、「行人道」、「綠色範圍」(只要是構成「發展項目公用地方與設施」一部分)、「渠務專用範圍」、「看更及管理員辦事處」及「業主委員會辦事處」；
- (b) 管理員宿舍、走廊、行車道、緊急發電機房、緊急車輛通道、風機房、消防控制室、樓梯平台、街道消防栓泵房、泵房、雨水儲存缸、斜路、垃圾及物料回收房、污水處理裝置機房、樓梯、電掣房、電訊及廣播設備室、變壓器房、電纜裝置及所有相關設施、非挖掘範圍、主水錶房、水錶櫃、街道消防栓水箱、消防花灑系統控制閘櫃、水箱；及
- (c) 「該土地」及「發展項目」內擬供「發展項目」整體公用與共享的地方及設施，

現於公契所附圖則以綠色、綠色間黑斜線及綠色間黑交叉線顯示，以資識別。

此外，於適當情況下，倘(i)「發展項目」任何部分符合「建築物管理條例」第2條中「公用部分」第(a)段的釋義及/或(ii)「發展項目」任何部分乃「建築物管理條例」附表1訂明而符合「建築物管理條例」第2條中「公用部分」第(b)段的釋義，此等部分將受制於前述之規定，並且視作屬於「發展項目公用地方與設施」的一部分。

「發展項目公用地方與設施」並不包括「屋苑公用地方與設施」、「住宅公用地方與設施」、「住宅大廈公用地方與設施」、「住宅大樓公用地方與設施」、「商業公用地方與設施」及「停車場公用地方與設施」；

「屋苑公用地方與設施」指：

- (a) 「發展項目」的邊界圍牆、電纜引入系統、「會所」及「停車場」專用消防及消防花灑系統泵房和水箱、行車道、緊急車輛通道、平台及天台(不附屬於任何「單位」)、斜路、變壓器房、電纜裝置及所有附屬設施、強電電掣房、電掣房、消防花灑系統控制閘櫃、「綠化地方」(只要是構成「屋苑公用地方與設施」一部分)；及
- (b) 「該土地」及「發展項目」內供「住宅樓宇」及「停車場」整體公用與共享的地方及設施，

現於公契所附圖則以黃色顯示，以資識別。

然而，只要情況適當，倘：(i)「住宅樓宇」及「停車場」任何部分符合「建築物管理條例」第2條中「公用部分」第(a)段的釋義及/或(ii)「住宅樓宇」及「停車場」任何部分乃「建築物管理條例」附表1訂明而符合「建築物管理條例」第2條中「公用部分」第(b)段的釋義，此等部份將受制於前述之規定，並視作屬於「屋苑公用地方與設施」的一部分。

公契的摘要

「屋苑公用地方與設施」並不包括「發展項目公用地方與設施」、「住宅公用地方與設施」、「住宅大廈公用地方與設施」、「住宅大樓公用地方與設施」、「商業公用地方」及「停車場公用地方與設施」；

「住宅大樓公用地方與設施」指：

(a) 「住宅大樓」的建築特色、幕牆(構成「住宅單位」一部分的窗除外)、「綠化地方」(只要是構成「住宅大樓公用地方與設施」一部分)、外牆(包括非結構性預製外牆)、平台及天台(不構成「住宅單位」一部分)、空調機平台、走廊、電錶房、水錶櫃、消防入水口、樓梯平台、電梯大堂、電梯、電梯井、電梯槽、水管槽、樓梯；及

(b) 「該土地」及「發展項目」內供「住宅大樓」整體公用與共享的地方及設施，

現於公契所附圖則以藍色顯示，以資識別。

然而，只要情況適當，倘：(i)「住宅大樓」任何部分符合「建築物管理條例」第2條中「公用部分」第(a)段的釋義及/或(ii)「住宅大樓」任何部分乃「建築物管理條例」附表1訂明而符合「建築物管理條例」第2條中「公用部分」第(b)段的釋義，此等部分將受制於前述之規定，並視作屬於「住宅大樓公用地方與設施」的一部分。

「住宅大樓公用地方與設施」並不包括「發展項目公用地方與設施」、「屋苑公用地方與設施」、「住宅公用地方與設施」、「住宅大廈公用地方與設施」、「商業公用地方」及「停車場公用地方與設施」；

「住宅公用地方與設施」指：

(a) 「單車停車位」、「綠化地方」(只要是構成「住宅公用地方與設施」一部分)、「保安護衛亭」、「康樂設施」、「住宅客貨上落車位」、「訪客停車位」及附屬於該處的電動車充電設施；

(b) 有蓋園景美化地方、行車道、電錶房、緊急車輛通道、室內游泳池濾水裝置機房、室外及室內游泳池濾水裝置機房、水景濾水裝置機房、消防入水口、樓梯平台、園景美化地方、草坪、電梯、電梯大堂、電梯井、電梯槽、電梯機房、水管槽、花槽、消防泵房、熱水泵房、食水泵房、食水及沖廁水泵房、泵房、斜路、樓梯、電掣房、通風井、走道、水景設施、水錶櫃、水錶房、消防水箱、沖廁水箱、食水水箱、水箱；及

(c) 「該土地」及「發展項目」內供「住宅樓宇」整體公用與共享的地方及設施，

現於公契所附圖則以橙色顯示，以資識別。

然而，只要情況適當，倘：(i)「住宅樓宇」任何部分符合「建築物管理條例」第2條中「公用部分」第(a)段的釋義及/或(ii)「住宅樓宇」任何部分乃「建築物管理條例」附表1訂明而符合「建築物管理條例」第2條中「公用部分」第(b)段的釋義，此等部份將受制於前述之規定，並視作屬於「住宅公用地方與設施」的一部分。

「住宅公用地方與設施」並不包括「發展項目公用地方與設施」、「屋苑公用地方與設施」、「住宅大廈公用地方與設施」、「住宅大樓公用地方與設施」、「商業公用地方」及「停車場公用地方與設施」；

「住宅大廈公用地方與設施」指：

(a) 「住宅大廈」的建築特色、幕牆(構成「住宅單位」一部分的窗除外)、「綠化地方」(只要是構成「住宅大廈公用地方與設施」一部分)、外牆(包括非結構性預製外牆)、平台、天台及上層天台、空調機機房(不構成「住宅單位」一部份)、空調機平台、裝設於「住宅大廈」天台之「住宅大廈公用地方與設施」空調機(如有者)、氣槽、走廊、天井管槽房、入口大堂、消防入水口、喉轆、樓梯平台、電梯井、電梯、電梯槽、電梯大堂、露天管井、水管槽、垃圾及物料回收室、樓梯、水錶櫃、電錶房；及

(b) 「該土地」及「發展項目」內供「住宅大廈」整體公用與共享的地方及設施，

現於公契所附圖則以紅色顯示，以資識別。

然而，只要情況適當，倘：(i)「住宅大廈」任何部分符合「建築物管理條例」第2條中「公用部分」第(a)段的釋義及/或(ii)「住宅大廈」任何部分乃「建築物管理條例」附表1訂明而符合「建築物管理條例」第2條中「公用部分」第(b)段的釋義，此等部分將受制於前述之規定，並視作屬於「住宅大廈公用地方與設施」的一部分。

「住宅大廈公用地方與設施」並不包括「發展項目公用地方與設施」、「屋苑公用地方與設施」、「住宅公用地方與設施」、「住宅大樓公用地方與設施」、「商業公用地方」及「停車場公用地方與設施」；

Summary of deed of mutual covenant

公契的摘要

B. 「發展項目」各住宅物業「不分割份數」之分配

1. 「住宅大樓」

座數	樓層	住宅單位	不分割份數	管理份數
A	地下低層和地下	G1 (花園複式1號)	311	311
	地下低層和地下	G2 (花園複式2號)	305	305
	地下低層和地下	G3 (花園複式3號)	305	305
	地下低層和地下	G5 (花園複式5號)	307	307
	1樓、2樓和3樓	P1 (頂層三複式1號)	327	327
	1樓、2樓和3樓	P2 (頂層三複式2號)	287	287
	1樓、2樓和3樓	P3 (頂層三複式3號)	325	325
	1樓、2樓和3樓	P5 (頂層三複式5號)	287	287
		小計：		2,454

座數	樓層	住宅單位	不分割份數	管理份數
B	地下低層和地下	G1 (花園複式1號)	305	305
	地下低層和地下	G2 (花園複式2號)	302	302
	地下低層和地下	G3 (花園複式3號)	304	304
	地下低層和地下	G5 (花園複式5號)	304	304
	1樓、2樓和3樓	P1 (頂層三複式1號)	327	327
	1樓、2樓和3樓	P2 (頂層三複式2號)	286	286
	1樓、2樓和3樓	P3 (頂層三複式3號)	325	325
	1樓、2樓和3樓	P5 (頂層三複式5號)	287	287
		小計：		2,440

座數	樓層	住宅單位	不分割份數	管理份數	
C	地下低層和地下	G1 (花園複式1號)	262	262	
	地下低層和地下	G2 (花園複式2號)	257	257	
	地下低層和地下	G3 (花園複式3號)	256	256	
	地下低層和地下	G5 (花園複式5號)	256	256	
	地下低層和地下	G6 (花園複式6號)	255	255	
	地下低層和地下	G7 (花園複式7號)	258	258	
	1樓和2樓	P1 (頂層複式1號)	222	222	
	1樓和2樓	P2 (頂層複式2號)	217	217	
	1樓和2樓	P3 (頂層複式3號)	219	219	
	1樓和2樓	P5 (頂層複式5號)	219	219	
	1樓和2樓	P6 (頂層複式6號)	217	217	
	1樓和2樓	P7 (頂層複式7號)	219	219	
		小計：		2,857	2,857

Summary of deed of mutual covenant

公契的摘要

座數	樓層	住宅單位	不分割份數	管理份數
D	地下低層和地下	G1 (花園複式1號)	210	210
	地下低層和地下	G2 (花園複式2號)	210	210
	地下低層和地下	G3 (花園複式3號)	210	210
	地下低層和地下	G5 (花園複式5號)	210	210
	地下低層和地下	G6 (花園複式6號)	210	210
	地下低層和地下	G7 (花園複式7號)	210	210
	地下低層和地下	G8 (花園複式8號)	210	210
	地下低層和地下	G9 (花園複式9號)	210	210
	地下低層和地下	G10 (花園複式10號)	210	210
	地下低層和地下	G11 (花園複式11號)	210	210
	地下低層和地下	G12 (花園複式12號)	210	210
	地下低層和地下	G15 (花園複式15號)	210	210
	地下低層和地下	G16 (花園複式16號)	210	210
	地下低層和地下	G17 (花園複式17號)	211	211

座數	樓層	住宅單位	不分割份數	管理份數	
D	1樓、2樓和3樓	P1 (頂層三複式1號)	252	252	
	1樓、2樓和3樓	P2 (頂層三複式2號)	253	253	
	1樓、2樓和3樓	P3 (頂層三複式3號)	253	253	
	1樓、2樓和3樓	P5 (頂層三複式5號)	253	253	
	1樓、2樓和3樓	P6 (頂層三複式6號)	253	253	
	1樓、2樓和3樓	P7 (頂層三複式7號)	253	253	
	1樓、2樓和3樓	P8 (頂層三複式8號)	253	253	
	1樓、2樓和3樓	P9 (頂層三複式9號)	253	253	
	1樓、2樓和3樓	P10 (頂層三複式10號)	253	253	
	1樓、2樓和3樓	P11 (頂層三複式11號)	253	253	
	1樓、2樓和3樓	P12 (頂層三複式12號)	253	253	
	1樓、2樓和3樓	P15 (頂層三複式15號)	253	253	
	1樓、2樓和3樓	P16 (頂層三複式16號)	253	253	
	1樓、2樓和3樓	P17 (頂層三複式17號)	252	252	
		小計：		6,481	6,481

座數	樓層	住宅單位	不分割份數	管理份數	
E	地下低層和地下	G1 (花園複式1號)	223	223	
	地下低層和地下	G2 (花園複式2號)	220	220	
	地下低層和地下	G3 (花園複式3號)	220	220	
	地下低層和地下	G5 (花園複式5號)	220	220	
	地下低層和地下	G6 (花園複式6號)	220	220	
	地下低層和地下	G7 (花園複式7號)	226	226	
	1樓、2樓和3樓	P1 (頂層三複式1號)	255	255	
	1樓、2樓和3樓	P2 (頂層三複式2號)	251	251	
	1樓、2樓和3樓	P3 (頂層三複式3號)	251	251	
	1樓、2樓和3樓	P5 (頂層三複式5號)	251	251	
	1樓、2樓和3樓	P6 (頂層三複式6號)	251	251	
	1樓、2樓和3樓	P7 (頂層三複式7號)	254	254	
		小計：		2,842	2,842

座數	樓層	住宅單位	不分割份數	管理份數	
F	地下低層和地下	G1 (花園複式1號)	224	224	
	地下低層和地下	G2 (花園複式2號)	221	221	
	地下低層和地下	G3 (花園複式3號)	221	221	
	地下低層和地下	G5 (花園複式5號)	224	224	
	1樓、2樓和3樓	P1 (頂層三複式1號)	254	254	
	1樓、2樓和3樓	P2 (頂層三複式2號)	251	251	
	1樓、2樓和3樓	P3 (頂層三複式3號)	251	251	
	1樓、2樓和3樓	P5 (頂層三複式5號)	255	255	
		小計：		1,901	1,901

公契的摘要

2. 「住宅大廈」

座數	樓層	住宅單位	不分割份數	管理份數
1	地下	A	172	172
		B	148	148
		C	112	112
		D	39	39
	1樓	A	181	181
		B	149	149
		C	101	101
		D	88	88
	2樓	A	181	181
		B	149	149
		C	105	105
	3樓	A	181	181
		B	149	149
		C	105	105
		D	91	91
	5樓	A	181	181
		B	149	149
		C	105	105
		D	91	91
	6樓	A	181	181
		B	149	149
		C	105	105
		D	91	91
	7樓	A	192	192
		B	161	161
		C	107	107
		D	97	97
		小計：		3,651

座數	樓層	住宅單位	不分割份數	管理份數	
2	地下	A	169	169	
		B	166	166	
		C	126	126	
		D	161	161	
	1樓	A	170	170	
		B	170	170	
		C	103	103	
		D	106	106	
		E	84	84	
	2樓	A	170	170	
		B	170	170	
		C	106	106	
		D	109	109	
		E	90	90	
	3樓	A	170	170	
		B	170	170	
		C	106	106	
		D	109	109	
		E	90	90	
	5樓	A	170	170	
		B	170	170	
		C	106	106	
		D	109	109	
		E	90	90	
	6樓	A	170	170	
		B	170	170	
		C	106	106	
		D	109	109	
		E	90	90	
	7樓	A	184	184	
		B	186	186	
		C	151	151	
		D	149	149	
		小計：		4,505	4,505

座數	樓層	住宅單位	不分割份數	管理份數	
3	地下	A	169	169	
		B	179	179	
		C	126	126	
		D	160	160	
	1樓	A	170	170	
		B	177	177	
		C	102	102	
		D	106	106	
		E	84	84	
	2樓	A	170	170	
		B	177	177	
		C	109	109	
		D	109	109	
		E	90	90	
	3樓	A	170	170	
		B	177	177	
		C	109	109	
		D	109	109	
		E	90	90	
	5樓	A	170	170	
		B	177	177	
		C	109	109	
		D	109	109	
		E	90	90	
	6樓	A	170	170	
		B	177	177	
		C	109	109	
		D	109	109	
		E	90	90	
	7樓	A	183	183	
		B	190	190	
		C	158	158	
		D	149	149	
		小計：		4,573	4,573

備註：「住宅大廈」樓層編號不設4樓，亦不設4座、13座、14座及24座。

Summary of deed of mutual covenant

公契的摘要

座數	樓層	住宅單位	不分割份數	管理份數
5	地下	A	182	182
		B	171	171
		C	165	165
		D	127	127
	1樓	A	177	177
		B	171	171
		C	106	106
		D	102	102
		E	84	84
	2樓	A	177	177
		B	171	171
		C	109	109
		D	109	109
		E	90	90
	3樓	A	177	177
		B	171	171
		C	109	109
		D	109	109
		E	90	90
	5樓	A	177	177
		B	171	171
		C	109	109
		D	109	109
		E	90	90
	6樓	A	177	177
		B	171	171
		C	109	109
		D	109	109
E		90	90	
7樓	A	190	190	
	B	183	183	
	C	149	149	
	D	158	158	
	小計：		4,589	4,589

座數	樓層	住宅單位	不分割份數	管理份數
6	地下	A	171	171
		B	171	171
		C	129	129
		D	166	166
	1樓	A	171	171
		B	171	171
		C	103	103
		D	106	106
		E	84	84
	2樓	A	171	171
		B	171	171
		C	106	106
		D	109	109
		E	90	90
	3樓	A	171	171
		B	171	171
		C	106	106
		D	109	109
		E	90	90
	5樓	A	171	171
		B	171	171
		C	106	106
		D	109	109
		E	90	90
	6樓	A	171	171
		B	171	171
		C	106	106
		D	109	109
E		90	90	
7樓	A	184	184	
	B	186	186	
	C	151	151	
	D	149	149	
	小計：		4,530	4,530

座數	樓層	住宅單位	不分割份數	管理份數
7	地下	A	171	171
		B	171	171
		C	127	127
		D	163	163
	1樓	A	171	171
		B	171	171
		C	103	103
		D	106	106
		E	84	84
	2樓	A	171	171
		B	171	171
		C	106	106
		D	109	109
		E	90	90
	3樓	A	171	171
		B	171	171
		C	106	106
		D	109	109
		E	90	90
	5樓	A	171	171
		B	171	171
		C	106	106
		D	109	109
		E	90	90
	6樓	A	171	171
		B	171	171
		C	106	106
		D	109	109
E		90	90	
7樓	A	184	184	
	B	186	186	
	C	151	151	
	D	149	149	
	小計：		4,525	4,525

備註：「住宅大廈」樓層編號不設4樓，亦不設4座、13座、14座及24座。

Summary of deed of mutual covenant

公契的摘要

座數	樓層	住宅單位	不分割份數	管理份數
8	地下	A	171	171
		B	171	171
		C	127	127
		D	161	161
	1樓	A	171	171
		B	171	171
		C	104	104
		D	106	106
		E	84	84
	2樓	A	171	171
		B	171	171
		C	107	107
		D	109	109
		E	90	90
	3樓	A	171	171
		B	171	171
		C	107	107
		D	109	109
		E	90	90
	5樓	A	171	171
		B	171	171
		C	107	107
		D	109	109
		E	90	90
	6樓	A	171	171
		B	171	171
		C	107	107
		D	109	109
E		90	90	
7樓	A	184	184	
	B	186	186	
	C	151	151	
	D	149	149	
	小計：		4,528	4,528

座數	樓層	住宅單位	不分割份數	管理份數
9	地下	A	171	171
		B	171	171
		C	129	129
		D	162	162
	1樓	A	171	171
		B	171	171
		C	105	105
		D	106	106
		E	84	84
	2樓	A	171	171
		B	171	171
		C	108	108
		D	109	109
		E	90	90
	3樓	A	171	171
		B	171	171
		C	108	108
		D	109	109
		E	90	90
	5樓	A	171	171
		B	171	171
		C	108	108
		D	109	109
		E	90	90
	6樓	A	171	171
		B	171	171
		C	108	108
		D	109	109
E		90	90	
7樓	A	184	184	
	B	186	186	
	C	152	152	
	D	149	149	
	小計：		4,537	4,537

座數	樓層	住宅單位	不分割份數	管理份數
10	地下	A	171	171
		B	171	171
		C	128	128
		D	163	163
	1樓	A	171	171
		B	171	171
		C	105	105
		D	107	107
		E	84	84
	2樓	A	171	171
		B	171	171
		C	108	108
		D	110	110
		E	90	90
	3樓	A	171	171
		B	171	171
		C	108	108
		D	110	110
		E	90	90
	5樓	A	171	171
		B	171	171
		C	108	108
		D	110	110
		E	90	90
	6樓	A	171	171
		B	171	171
		C	108	108
		D	110	110
E		90	90	
7樓	A	184	184	
	B	186	186	
	C	152	152	
	D	150	150	
	小計：		4,543	4,543

備註：「住宅大廈」樓層編號不設4樓，亦不設4座、13座、14座及24座。

Summary of deed of mutual covenant

公契的摘要

座數	樓層	住宅單位	不分割份數	管理份數
11	地下	A	171	171
		B	171	171
		C	128	128
		D	162	162
	1樓	A	171	171
		B	171	171
		C	105	105
		D	107	107
		E	84	84
	2樓	A	171	171
		B	171	171
		C	108	108
		D	110	110
		E	90	90
	3樓	A	171	171
		B	171	171
		C	108	108
		D	110	110
		E	90	90
	5樓	A	171	171
		B	171	171
		C	108	108
		D	110	110
		E	90	90
	6樓	A	171	171
		B	171	171
		C	108	108
		D	110	110
E		90	90	
7樓	A	184	184	
	B	186	186	
	C	152	152	
	D	150	150	
	小計：		4,542	4,542

座數	樓層	住宅單位	不分割份數	管理份數
12	地下	A	171	171
		B	171	171
		C	127	127
		D	162	162
	1樓	A	171	171
		B	171	171
		C	105	105
		D	107	107
		E	84	84
	2樓	A	171	171
		B	171	171
		C	108	108
		D	110	110
		E	90	90
	3樓	A	171	171
		B	171	171
		C	108	108
		D	110	110
		E	90	90
	5樓	A	171	171
		B	171	171
		C	108	108
		D	110	110
		E	90	90
	6樓	A	171	171
		B	171	171
		C	108	108
		D	110	110
E		90	90	
7樓	A	184	184	
	B	186	186	
	C	152	152	
	D	150	150	
	小計：		4,541	4,541

座數	樓層	住宅單位	不分割份數	管理份數
15	地下	A	171	171
		B	171	171
		C	128	128
		D	161	161
	1樓	A	171	171
		B	171	171
		C	105	105
		D	107	107
		E	84	84
	2樓	A	171	171
		B	171	171
		C	108	108
		D	110	110
		E	90	90
	3樓	A	171	171
		B	171	171
		C	108	108
		D	110	110
		E	90	90
	5樓	A	171	171
		B	171	171
		C	108	108
		D	110	110
		E	90	90
	6樓	A	171	171
		B	171	171
		C	108	108
		D	110	110
E		90	90	
7樓	A	184	184	
	B	186	186	
	C	152	152	
	D	150	150	
	小計：		4,541	4,541

備註：「住宅大廈」樓層編號不設4樓，亦不設4座、13座、14座及24座。

Summary of deed of mutual covenant

公契的摘要

座數	樓層	住宅單位	不分割份數	管理份數
16	地下	A	171	171
		B	157	157
		C	158	158
		D	162	162
	1樓	A	171	171
		B	159	159
		C	130	130
		D	107	107
		E	84	84
	2樓	A	171	171
		B	159	159
		C	133	133
		D	110	110
		E	90	90
	3樓	A	171	171
		B	159	159
		C	133	133
		D	110	110
		E	90	90
	5樓	A	171	171
		B	159	159
		C	133	133
		D	110	110
		E	90	90
	6樓	A	171	171
		B	159	159
		C	133	133
		D	110	110
E		90	90	
7樓	A	184	184	
	B	174	174	
	C	183	183	
	D	150	150	
	小計：		4,642	4,642

座數	樓層	住宅單位	不分割份數	管理份數
17	地下	A	114	114
		B	104	104
		C	85	85
		D	95	95
	1樓	A	121	121
		B	113	113
		C	81	81
		D	91	91
	2樓	A	121	121
		B	113	113
		C	84	84
		D	94	94
	3樓	A	121	121
		B	113	113
		C	84	84
		D	94	94
	5樓	A	121	121
		B	113	113
		C	84	84
		D	94	94
6樓	A	131	131	
	B	122	122	
	C	91	91	
	D	103	103	
	小計：		2,487	2,487

座數	樓層	住宅單位	不分割份數	管理份數
18	地下	A	107	107
		B	108	108
		C	85	85
		D	85	85
	1樓	A	108	108
		B	108	108
		C	81	81
		D	81	81
	2樓	A	108	108
		B	108	108
		C	84	84
		D	84	84
	3樓	A	108	108
		B	108	108
		C	84	84
		D	84	84
	5樓	A	108	108
		B	108	108
		C	84	84
		D	84	84
6樓	A	117	117	
	B	117	117	
	C	91	91	
	D	91	91	
	小計：		2,331	2,331

備註：「住宅大廈」樓層編號不設4樓，亦不設4座、13座、14座及24座。

Summary of deed of mutual covenant

公契的摘要

座數	樓層	住宅單位	不分割份數	管理份數
19	地下	A	108	108
		B	105	105
		C	85	85
		D	85	85
	1樓	A	108	108
		B	108	108
		C	81	81
		D	81	81
	2樓	A	108	108
		B	108	108
		C	84	84
		D	84	84
	3樓	A	108	108
		B	108	108
		C	84	84
		D	84	84
	5樓	A	108	108
		B	108	108
		C	84	84
		D	84	84
6樓	A	117	117	
	B	117	117	
	C	91	91	
	D	91	91	
	小計：		2,329	2,329

座數	樓層	住宅單位	不分割份數	管理份數
20	地下	A	105	105
		B	108	108
		C	85	85
		D	85	85
	1樓	A	108	108
		B	108	108
		C	81	81
		D	81	81
	2樓	A	108	108
		B	108	108
		C	84	84
		D	84	84
	3樓	A	108	108
		B	108	108
		C	84	84
		D	84	84
	5樓	A	108	108
		B	108	108
		C	84	84
		D	84	84
6樓	A	117	117	
	B	117	117	
	C	91	91	
	D	91	91	
	小計：		2,329	2,329

座數	樓層	住宅單位	不分割份數	管理份數
21	地下	A	108	108
		B	105	105
		C	85	85
		D	85	85
	1樓	A	108	108
		B	108	108
		C	81	81
		D	81	81
	2樓	A	108	108
		B	108	108
		C	84	84
		D	84	84
	3樓	A	108	108
		B	108	108
		C	84	84
		D	84	84
	5樓	A	108	108
		B	108	108
		C	84	84
		D	84	84
6樓	A	117	117	
	B	117	117	
	C	91	91	
	D	91	91	
	小計：		2,329	2,329

備註：「住宅大廈」樓層編號不設4樓，亦不設4座、13座、14座及24座。

Summary of deed of mutual covenant

公契的摘要

座數	樓層	住宅單位	不分割份數	管理份數
22	地下	A	102	102
		B	66	66
		C	40	40
		D	65	65
	1樓	A	109	109
		B	44	44
		C	43	43
		D	42	42
		E	67	67
	2樓	A	109	109
		B	44	44
		C	43	43
		D	42	42
		E	67	67
	3樓	A	118	118
		B	47	47
		C	46	46
		D	46	46
		E	73	73
		小計：		1,213

座數	樓層	住宅單位	不分割份數	管理份數	
23	地下	A	65	65	
		B	40	40	
		C	66	66	
		D	40	40	
		E	65	65	
	1樓	A	67	67	
		B	42	42	
		C	43	43	
		D	43	43	
		E	42	42	
		F	67	67	
	2樓	A	67	67	
		B	42	42	
		C	43	43	
		D	43	43	
		E	42	42	
		F	67	67	
	3樓	A	73	73	
		B	46	46	
		C	46	46	
		D	46	46	
		E	46	46	
		F	73	73	
		小計：		1,214	1,214

座數	樓層	住宅單位	不分割份數	管理份數	
25	地下低層及地下	A	177	177	
		B	167	167	
		C	166	166	
		D	175	175	
	地下	E	96	96	
		F	97	97	
	1樓	A	94	94	
		B	95	95	
		C	103	103	
		D	103	103	
	2樓	A	99	99	
		B	99	99	
		C	107	107	
		D	107	107	
	3樓	A	107	107	
		B	107	107	
		C	116	116	
		D	115	115	
		小計：		2,130	2,130

備註：「住宅大廈」樓層編號不設4樓，亦不設4座、13座、14座及24座。

公契的摘要

C. 「發展項目」經理人的任期

「發展項目」的經理人首屆任期為兩(2)年，由「本契約」生效日開始，嗣後「經理人」將繼續履任，直至經理人根據「公契及管理協議」規定發出不少於三(3)個曆月的終止通知書，其委任權責即告終止。

D. 「發展項目」的住宅物業業主攤付管理開支的原則

- (a) 每名「單位」「業主」應攤付年度預算案第一部分的預算「管理開支」（第一部分涵蓋乃本着全體「業主」利益，並且乃完善管理「該土地」及「發展項目」、「發展項目公用地方與設施」、「綠色範圍」、「綠色範圍構築物」、「綠色間黑斜線範圍」及「棕色範圍」所需或必要的所有開支），分擔比例為其「單位」的「管理份數」對「發展項目」的「管理份數」總額；
- (b) 每名「住宅單位」或「停車位」「業主」應攤付年度預算案第二部分的預算「管理開支」（第二部分涵蓋關乎「屋苑公用地方與設施」的所有開支），分擔比例為其「單位」的「管理份數」對所有「住宅單位」及「停車位」的「管理份數」總額；
- (c) 每名「住宅單位」「業主」應攤付年度預算案第三部分的預算「管理開支」（第三部分涵蓋關乎「住宅公用地方與設施」的所有開支），分擔比例為其「住宅單位」的「管理份數」對所有「住宅單位」的「管理份數」總額；
- (d) 每名「花園複式單位」、「頂樓複式單位」或「頂樓三層式單位」「業主」應攤付年度預算案第四部分的預算「管理開支」（第四部分涵蓋關乎「住宅大樓公用地方與設施」的所有開支），分擔比例為其「單位」的「管理份數」對所有「花園複式單位」、「頂樓複式單位」或「頂樓三層式單位」的「管理份數」總額；
- (e) 每名「居住單位」「業主」應攤付年度預算案第五部分的預算「管理開支」（第五部分涵蓋關乎「住宅大廈公用地方與設施」的所有開支），分擔比例為其「居住單位」的「管理份數」對所有「居住單位」的「管理份數」總額；
- (f) 「住宅單位」「業主」應分擔年度預算案第六部分所列預算「管理開支」的6.16%（第六部分涵蓋關乎「停車場公用地方與設施」的所有開支），即每個「住宅單位」「業主」攤付的款項相等於其「住宅單位」的「管理份數」對所有「住宅單位」的「管理份數」總額。

E. 「管理開支」按金的訂立

按金相等於兩個月之其應付之攤付「管理開支」。上述按金不可退還但可以轉戶。

F. 「發展項目」預留供賣方自用的範圍

不適用。

註：欲悉詳情請參考「公契」。「公契」全文已備於售樓處，歡迎在營業時間免費索取閱覽，並可支付必要的影印費用影印副本。

Summary of land grant

批地文件的摘要

1. The Development is constructed on Lot No. 898 in Demarcation District No. 227 (the "Lot") which is held under New Grant No. 21303 (the "Land Grant").
2. The Lot is granted for a term of 50 years commencing from 13 October 2011.
3. Special Condition No. (5) of the Land Grant stipulates that:-
 - (a) The Grantee shall:
 - (i) within 84 calendar months from the date of the Land Grant or such other extended periods as may be approved by the Director of Lands (the "Director"), at his own expense, in such manner with such materials and to such standards, levels, alignment and design as the Director shall approve and in all respects to the satisfaction of the Director:
 - (I) lay and form those portions of future public roads shown coloured green on PLAN I annexed to the Land Grant (hereinafter collectively referred to as the "Green Areas"); and
 - (II) provide and construct such bridges, tunnels, overpasses, under-passes, culverts, viaducts, flyovers, pavements, roads or such other structures as the Director in his sole discretion may require (hereinafter collectively referred to as the "Structures")so that building, vehicular and pedestrian traffic may be carried on the Green Areas.
 - (ii) within 84 calendar months from the date of the Land Grant or such other extended periods as may be approved by the Director; at his own expense and to the satisfaction of the Director; surface, kerb and channel the Green Areas and provide the same with such gullies, sewers, drains, fire hydrants with pipes connected to water mains, street lights, traffic signs, street furniture and road markings as the Director may require; and
 - (iii) maintain at his own expense the Green Areas together with the Structures and all structures, surfaces, gullies, sewers, drains, fire hydrants, services, street lights, traffic signs, street furniture, road markings and plant constructed, installed and provided thereon or therein to the satisfaction of the Director until such time as possession of the Green Areas has been re-delivered to the Government in accordance with Special Condition No. (6) of the Land Grant.
4. Special Condition No. (9)(a) of the Land Grant stipulates that:-

The Grantee shall within 84 calendar months from the date of the Land Grant, at his own expense, in such manner with such materials and to such standards, levels, alignment and specifications as the Director shall require or approve and in all respects to the satisfaction of the Director; provide and construct a paved road with pavement and such associated street furniture, traffic aids, street lights, sewers, drains and other structures within the areas shown coloured pink stippled black hatched red and pink stippled black hatched black hatched red on PLAN I annexed to the Land Grant or within such other area or areas as may be approved in writing by the Director (hereinafter collectively referred to as the "Emergency Vehicular Access").
5. Special Condition No. (9)(c) of the Land Grant stipulates that:-

The Grantee shall throughout the term hereby agreed to be granted at his own expense uphold, maintain and repair the Emergency Vehicular Access and everything forming a portion of or pertaining to it in a clean, tidy and unobstructed condition and in good and substantial repair to the satisfaction of the Director. In the event of the Emergency Vehicular Access not being so upheld, maintained and repaired, it shall be lawful for the Government, the Director or any person or persons authorized by him to make arrangements for the cleaning, tidying or repairing or otherwise in respect of the Emergency Vehicular Access for such period as the Director thinks fit at the cost of the Grantee who shall on demand pay to the Government a sum equal to the cost thereof, such sum to be determined by the Director whose determination shall be final and shall be binding upon the Grantee.
6. Special Condition No. (10) of the Land Grant stipulates that:-

The Grantee shall develop the lot by the erection thereon of a building or buildings complying in all respects with these Conditions and all Ordinances, bye-laws and regulations relating to building, sanitation and planning which are or may at any time be in force in Hong Kong, such building or buildings to be completed and made fit for occupation on or before the 31st day of December, 2018.
7. Special Condition No. (11) of the Land Grant stipulates that:-

The lot or any part thereof or any building or buildings erected or to be erected thereon shall not be used for any purpose other than for non-industrial (excluding hotel, petrol filling station and godown) purposes.
8. Special Condition No. (12) of the Land Grant stipulates that:-

No tree growing on the lot or adjacent thereto shall be removed or interfered with without the prior written consent of the Director who may, in granting consent, impose such conditions as to transplanting, compensatory landscaping or replanting as he may deem appropriate.
9. Special Condition No. (13) of the Land Grant stipulates that:-
 - (a) The Grantee shall submit or cause to be submitted to the Director of Planning for his approval a landscape master plan indicating the landscaping proposals for the lot.
 - (b) The landscape master plan shall be at a scale of 1:500 or larger and shall contain information on the landscaping proposals including a survey and treatment of existing trees, site layout and formation levels conceptual form of building development, illustrative layout of hard and soft landscaping areas and such other information as the Director of Planning may require. No site formation works shall be commenced on the lot or any part thereof until consent, if required, has been given in respect of the proposals for the preservation of trees under Special Condition No. (12) of the Land Grant.
 - (c) Upon development or redevelopment of the lot, the Grantee shall at his own expense landscape the lot in accordance with the approved landscape master plan and no amendment, variation, alteration, modification or substitution shall be made without the prior written consent of the Director.
 - (d) The Grantee shall throughout the term hereby agreed to be granted at his own expense keep and maintain the landscaped works carried out in accordance with sub-clause (c) of this Special Condition in a safe, clean, neat, tidy, functional and healthy condition all to the satisfaction of the Director.

Summary of land grant

批地文件的摘要

10. Special Condition No. (16) of the Land Grant stipulates that:-

- (a) The Grantee may erect, construct and provide within the lot such recreational facilities and facilities ancillary thereto (hereinafter referred to as the "**Facilities**") as may be approved in writing by the Director. The type, size, design, height and disposition of the Facilities shall also be subject to the prior written approval of the Director.
- (b) For the purpose of calculating the total gross floor area and the total site coverage respectively stipulated in Special Condition Nos. (14)(c) and (14)(f) of the Land Grant, any part of the Facilities provided within the lot in accordance with sub-clause (a) of this Special Condition which are for the common use and benefit of all the residents of the residential block or blocks erected or to be erected on the lot and their bona fide visitors shall not be taken into account. The remaining part of the Facilities which, in the opinion of the Director, are not for such use shall be taken into account for such calculations.
- (c) In the event that any part of the Facilities is exempted from the gross floor area and site coverage calculations pursuant to sub-clause (b) of this Special Condition (hereinafter referred to as the "**Exempted Facilities**"):
 - (i) The Exempted Facilities shall be designated as and form part of the Common Areas referred to in Special Condition No. (23)(a)(v) of the Land Grant; and
 - (ii) The Grantee shall at his own expense maintain the Exempted Facilities in good and substantial repair and condition and shall operate the Exempted Facilities to the satisfaction of the Director; and
 - (iii) The Exempted Facilities shall only be used by the residents of the residential block or blocks erected or to be erected within the lot and their bona fide visitors and by no other person or persons.

11. Special Condition No. (27) of the Land Grant stipulates that:-

- (a) The Residential Parking Spaces (as defined in the Land Grant) shall not be:
 - (i) assigned except
 - (I) together with undivided shares in the lot giving the right of exclusive use and possession of a residential unit or units in the building or buildings erected or to be erected on the lot; or
 - (II) to a person who is already the owner of undivided shares in the lot with the right of exclusive use and possession of a residential unit or units in the building or buildings erected or to be erected on the lot; or
 - (ii) underlet except to residents of the residential units in the building or buildings erected or to be erected on the lot.

Provided that in any event not more than three in number of the Residential Parking Spaces shall be assigned to the owner or underlet to the resident of any one residential unit in the building or buildings erected or to be erected on the lot.

12. Special Condition No. (32) of the Land Grant stipulates that:-

- (a) The lot is granted together with a right for the Grantee and his servants, visitors, workmen and other persons authorized by him in that behalf from time to time and at all times during the term hereby agreed to be granted for all purposes connected with the proper use and enjoyment of the lot to pass and repass, on, along, over, by and through the areas shown coloured brown on PLAN I annexed to the Land Grant (hereinafter collectively referred to as the "Brown Areas") at such levels as may be approved by the Director.
- (b) The Grantee shall, before any building works (excluding site formation works) commence on the lot or within such other time limit as may be specified by the Director, at his own expense, in such manner, with such materials and to such standards as the Director shall require or approve, construct a paved way with the associated street furniture, traffic aids, street lighting, sewers, drains and other structures on the Brown Areas over and along which a right of way referred to in sub-clause (a) of this Special Condition is given.
- (c) The Grantee shall at his own expense uphold, maintain and repair the Brown Areas and everything forming a portion of or pertaining to them, all to be done to the satisfaction of the Director and the Grantee shall be responsible for the whole as if he were the absolute owner thereof.
- (d) Any alteration to any public road absorbing a portion or portions of the Brown Areas over and along which a right of way is given or affecting the gradient thereof shall not give rise to any claim by the Grantee who shall at his own expense carry out all consequent alterations to the paved way constructed by him to the satisfaction of the Director.
- (e) The grant of the right of way referred to in sub-clause (a) of this Special Condition shall not give the Grantee the exclusive right over the Brown Areas. The Government shall have the right to grant rights of way over the Brown Areas to the owners of any other lots in the vicinity now or at any time in the future, or to take over the whole or any portion of the Brown Areas for the purposes of a public street without payment of any compensation to the Grantee or to other owners to whom rights of way over the whole or any portion of the Brown Areas may have been granted.
- (f) In the event of the non-fulfillment of the Grantee's obligations under sub-clauses (b) and (c) of this Special Condition, the Government may carry out the necessary construction, maintenance and repair works at the cost of the Grantee who shall pay to the Government on demand a sum equal to the cost thereof, such sum to be determined by the Director whose determination shall be final and shall be binding upon the Grantee.
- (g) Notwithstanding the grant of the right of way referred to in sub-clause (a) of this Special Condition, the Government shall have the full right and power, upon giving to the Grantee not less than fourteen days' written notice (save in case of emergency) to lay, install, relay, divert, remove, re-provision, replace, inspect, operate, repair, maintain and renew any Government or other drain, culvert, waterway or watercourse, sewer, nullah, water main, pipe, cable, wire, line, utility service or other works or installations (all together hereinafter referred to as the "**services**") which are now or may hereafter be upon, over, under or adjacent to the Brown Areas as the Director may in his absolute discretion deem fit, making good any and all damages caused thereby, and the Director, his Officers, contractors and any other persons authorized by him, his or their workmen with or without tools, equipment, plant, machinery or motor vehicles shall have the right of free ingress, egress and regress at all times to and from the Brown Areas for the purposes aforesaid. The Grantee shall not disturb or allow anybody to disturb the services without the prior written approval from the Director. Save in respect of making good any and all damage caused by any exercise of the aforesaid rights and powers, the Government, the Director, his officers, contractors and any other persons authorized by him, his or their workmen shall have no liability in respect of any loss, damage, nuisance or disturbance whatsoever caused to or suffered by the Grantee arising out of or incidental to the exercise of the rights conferred under this sub-clause, and no claim nor objection shall be made against him or them by the Grantee.

Summary of land grant

批地文件的摘要

13. Special Condition No. (33) of the Land Grant stipulates that:-

- (a) (i) There is excepted and reserved to the Government the portion of the lot as shown coloured pink stippled black hatched blue on PLAN I annexed to the Land Grant from a level of approximately 105 metres above the Hong Kong Principal Datum to about 0.5 metre below the existing ground level (hereinafter referred to as the "**Underground Stratum**"). The Grantee shall have no right of or title to the ownership, possession or use and no right or claim to compensation whatsoever in respect of the Underground Stratum. For the purpose of this Special Condition, the decision of the Director as to what constitutes the existing ground level shall be final and binding upon the Grantee.
- (ii) There is also excepted and reserved to the Government, its officers, lessees, tenants, licensees or persons authorized by it the free right and liberty throughout the term hereby agreed to be granted to construct, install, operate, maintain, repair and renew within the Underground Stratum a foul water pipeline in such manner and for the use of such persons as the Government may see fit.
- (b) There are excepted and reserved to the Government, its officers, lessees, tenants, licensees or persons authorized by it and the owners and occupiers for the time being of the Underground Stratum or any part thereof freely without interruption and without payment of any nature,
 - (i) the right to all necessary easements and privileges including but not limited to the right of shelter, support and protection from the lot for such parts of the Underground Stratum which require such shelter, support and protection as decided by the Director whose decision shall be final and binding on the Grantee;
 - (ii) the right with or without motor vehicles, plant, tools, equipment and machinery of free ingress, egress and regress at all times to and from the Underground Stratum through the Green Areas, the Brown Areas, the lot or any part thereof and any building or buildings erected or to be erected thereon for the purposes of sub-clause (a)(ii) of this Special Condition; and
 - (iii) the right to carry out any construction, installation, maintenance, repair, renewal, inspection, relaying and diversion works or any other works within the Underground Stratum as may be required by the Director.
- (c) The Grantee shall take or cause to be taken all proper and adequate care, skill and precautions at all times, and particularly when carrying out construction, maintenance, renewal or repair work to avoid causing any damage, disturbance or obstruction to the Underground Stratum or the foul water pipeline therein and the Grantee shall at his own expense in all respects repair, make good and reinstate to the satisfaction of the Director any damage, disturbance or obstruction to the Underground Stratum or the foul water pipeline therein so caused. If the Grantee fails to carry out any such necessary repairing, making good and reinstatement of the Underground Stratum or any part thereof or the foul water pipeline therein to the satisfaction of the Director, the Director may carry out such repairing, making good or reinstatement as he considers necessary and the Grantee shall pay to the Government on demand a sum equal to the cost thereof, such sum to be determined by the Director whose determination shall be final and shall be binding upon the Grantee. The Grantee hereby indemnifies and shall keep indemnified the Government from and against all actions, proceedings, loss, damages, expenses, claims and demands whatsoever arising out of any damage or nuisance to private property caused by such damage, disturbance and obstruction to the Underground Stratum or the foul water pipeline therein by the Grantee.
- (d) The Government, its officers, lessees, tenants, licensees and persons authorized by it shall have no liability in respect of any loss, damage, nuisance or disturbance whatsoever caused to or suffered by the Grantee arising out of or incidental to the construction, presence or operation of the Underground Stratum and the foul water pipeline therein or out of or incidental to the exercise by it or them of the rights conferred under this Special Condition and no claim shall be made against it or them by the Grantee.

14. Special Condition No. (34) of the Land Grant stipulates that:-

- (a) The Grantee acknowledges that there is an existing footpath transversing the lot from the western boundary of the lot at point A shown and marked on PLAN I annexed to the Land Grant to the eastern boundary of the lot and annotated "FP" (hereinafter referred to as the "**existing footpath**"). The Grantee shall at his own expense, within such time limit and in compliance with such conditions or requirements as may be imposed by the Director, and to the satisfaction of the Director, replace the existing footpath by the construction and completion of a new footpath at such levels or alignments in such manner, with such materials and to such design, standard and specifications as the Director may approve or require connecting the points A and B shown and marked on PLAN I annexed to the Land Grant (hereinafter referred to as the "**Footpath**"). For the avoidance of doubt, the Grantee shall not demolish, close or divert the existing footpath or any part thereof without the prior written approval of the Director.
- (b) At all times during the term hereby agreed to be granted, the Grantee shall permit the Government, its officers or authorized persons and all members of the public for all lawful purposes and without payment of any nature whatsoever to pass and repass on foot on, along, over by and through the existing footpath prior to its closure and the Footpath.
- (c) The Grantee shall throughout the term hereby agreed to be granted at his own expense manage maintain and repair the existing footpath prior to its closure and the Footpath in good and substantial repair and condition and in all respects to the satisfaction of the Director.
- (d) The Grantee hereby indemnifies and shall keep indemnified the Government and the Director from and against all liabilities and all actions, proceedings, costs, claims, expenses, losses, damages, charges and demands of whatsoever nature arising out of or in connection with:
 - (i) anything done or omitted to be done by the Grantee, his agents, workmen and contractors in connection with the management, maintenance or repair of the existing footpath prior to its closure or the Footpath;
 - (ii) the demolition, closure or diversion of the existing footpath or part thereof; or
 - (iii) the construction of the Footpath.
- (e) It is hereby expressly agreed, declared and provided that by imposing the obligation on the part of the Grantee contained in sub-clause (b) of this Special Condition, neither the Grantee intends to dedicate nor the Government consents to any dedication of the existing footpath or part thereof prior to its closure or the Footpath or part thereof or part of the lot to the public for the right of passage.
- (f) It is expressly agreed and declared that the obligation on the part of the Grantee contained in sub-clause (b) of this Special Condition will give rise to no expectation of, or claim for or in respect of, any concession or right in respect of additional site coverage or plot ratio whether under Regulation 22(1) of the Building (Planning) Regulations, any amendment thereto, substitution therefor, or otherwise and for the avoidance of doubt the Grantee expressly waives any and all claims in respect of or for any concession in respect of, or right to, additional site coverage or plot ratio under Regulation 22(1) of the Building (Planning) Regulations, any amendment thereto or substitution therefor.

批地文件的摘要

- (g) in the event of the non-fulfilment of the Grantee's obligation under sub-clauses (a) and (c) of this Special Condition, the Government may carry out the necessary construction, maintenance or repair works at the cost of the Grantee who shall pay to the Government on demand a sum equal to the cost thereof, such sum to be determined by the Director whose determination shall be final and binding upon the Grantee. For the purpose of carrying out the works aforesaid, the Government, its officers, agents, contractors, workmen or other duly authorized personnel shall have a free and uninterrupted right at an reasonable times to enter into the lot or any part thereof and any building or buildings erected or to be erected thereon. The Government, its officers, agent, contractors, workmen or other duly authorized personnel shall have no liability in respect of any loss, damage, nuisance or disturbance whatsoever caused to or suffered by the Grantee arising out of or incidental to the exercise by it or them of the rights conferred under this sub-clause, and no claim for compensation or otherwise shall be made against it or them by the Grantee in respect of such loss, damage, nuisance or disturbance.
15. Special Condition No. (36) of the Land Grant stipulates that:-
- (a) Where there is or has been any cutting away, removal or setting back of any land, or any building-up or filling-in or any slope treatment works of any kind whatsoever, whether with or without the prior written consent of the Director, either within the lot or on any Government land, which is or was done for the purpose of or in connection with the formation, levelling or development of the lot or any part thereof or any other works required to be done by the Grantee under these Conditions, or for any other purpose, the Grantee shall at his own expense carry out and construct such slope treatment works, retaining walls or other support, protection, drainage or ancillary or other works as shall or may then or at any time thereafter be necessary to protect and support such land within the lot and also any adjacent or adjoining Government or leased land and to obviate and prevent any falling away, landslip or subsidence occurring thereafter. The Grantee shall at all times during the term hereby agreed to be granted maintain at his own expense the said land, slope treatment works, retaining walls or other support, protection, drainage or ancillary or other works in good and substantial repair and condition to the satisfaction of the Director.
- (b) Nothing in sub-clause (a) of this Special Condition shall prejudice the Government's rights under these Conditions, in particular Special Condition No. (35) of the Land Grant.
- (c) In the event that as a result of or arising out of any formation, levelling, development or other works done by the Grantee or owing to any other reason, any falling away, landslip or subsidence occurs at any time, whether in or from any land within the lot or from any adjacent or adjoining Government or leased land, the Grantee shall at his own expense reinstate and make good the same to the satisfaction of the Director and shall indemnify the Government, its agents and contractors from and against all costs, charges, damages, demands and claims whatsoever which shall or may be made, suffered or incurred through or by reason of such falling away, landslip or subsidence.
- (d) In addition to any other rights or remedies herein provided for breach of any of these Conditions, the Director shall be entitled by notice in writing to call upon the Grantee to carry out, construct and maintain the said land, slope treatment works, retaining walls, or other support, protection, and drainage or ancillary or other works or to reinstate and make good any falling away, landslip or subsidence, and if the Grantee shall neglect or fail to comply with the notice to the satisfaction of the Director within the period specified therein, the Director may forthwith execute and carry out any necessary works and the Grantee shall on demand repay to the Government the cost thereof, together with any administrative or professional fees and charges.
16. Special Condition No. (37) of the Land Grant stipulates that:-
- (a) The Grantee shall at his own expense carry out and complete to the satisfaction of the Director such geotechnical investigations and such slope treatment, landslide preventive, mitigation and remedial works on the area shown coloured green hatched black on PLAN I annexed to the Land Grant (hereinafter referred to as the "**Green Hatched Black Area**") as the Director in his absolute discretion may require and shall, at all times during the term hereby agreed to be granted, at his own expense, maintain in good and substantial repair and condition to the satisfaction of the Director the Green Hatched Black Area including all land, slope treatment works, earth-retaining structures, drainage and any other works therein and thereon. In the event that any landslip, subsidence or falling away occurs within the Green Hatched Black Area at any time during the term hereby agreed to be granted, the Grantee shall at his own expense reinstate and make good the same to the satisfaction of the Director together with any adjacent-or adjoining areas which, in the opinion of the Director (whose decision shall be final and binding on the Grantee), have also been affected. The Grantee shall indemnify the Government, its agents and contractors against all claims, proceedings, costs, damages and expenses whatsoever incurred by reason of such landslip, subsidence or falling away. The Grantee shall ensure at all times that there shall be no illegal excavation or dumping on the Green Hatched Black Area and, subject to the prior written approval of the Director, the Grantee may erect fences or other barriers for the prevention of such illegal excavation or dumping. In addition to any other rights or remedies the Director may have in respect of any breach of these Conditions, the Director may at any time by notice in writing call upon the Grantee to carry out such geotechnical investigations, slope treatment, landslip preventive, mitigation and remedial works and to maintain, reinstate and make good any land, structure or works affected by such landslip, subsidence or falling away, and if the Grantee shall neglect or fail to comply with such notice to the satisfaction of the Director within the period specified therein, the Director may, after the expiry of such period, execute and carry out the required works and the Grantee shall on demand repay to the Government the cost thereof.
- (b) Notwithstanding sub-clause (a) of this Special Condition, the obligations and rights of the Grantee in respect of the Green Hatched Black Area or any part thereof under this Special Condition shall absolutely determine upon the Government giving to the Grantee notice to that effect, and no claim for compensation shall be made against the Government or the Director or his authorized officer by the Grantee in respect of any loss, damage or disturbance suffered or any expense incurred as a result of such determination. However, such determination shall be without prejudice to any rights or remedies of the Government in respect of any antecedent breach, non-performance or non-observance of the said sub-clause (a).
17. Special Condition No. (39) of the Land Grant stipulates that:-
- Where prestressed ground anchors have been installed, upon development or redevelopment of the lot or any part thereof, the Grantee shall at his own expense carry out regular maintenance and regular monitoring of the prestressed ground anchors throughout their service life to the satisfaction of the Director and shall supply to the Director such reports and information on all such monitoring works as the Director may from time to time in his absolute discretion require. If the Grantee shall neglect or fail to carry out the required monitoring works, the Director may forthwith execute and carry out the monitoring works and the Grantee shall on demand repay to the Government the cost thereof.
18. Special Condition No. (40) of the Land Grant stipulates that:-
- (a) Except for the Emergency Vehicular Access within the area shown coloured pink stippled black hatched black hatched red on PLAN I annexed to the Land Grant in accordance with Special Condition No. (9) of the Land Grant, no building or structure or foundation or support for any building or structure shall be erected on, above, below or within the areas shown coloured pink hatched black, pink stippled black hatched black and pink stippled black hatched black hatched red on PLAN I annexed to the Land Grant (which areas are hereinafter collectively referred to as the "**Combined Utilities and Drainage Reserve**"). Subject to the prior written approval of the Director, the Combined Utilities and Drainage Reserve may be diverted or relocated to such other area or areas of the lot.

批地文件的摘要

- (b) The Government and its officers, workmen, contractors or agents (hereinafter collectively referred to as the **"authorized persons"**) with or without tools, equipment, machinery or motor vehicles shall have the right of unrestricted ingress, egress and regress at all times to, from and through the lot to lay, repair, maintain, inspect and renew any drains, sewers, channels, drainage facilities, water and other services across, through or under the Combined Utilities and Drainage Reserve and to close the Combined Utilities and Drainage Reserve temporarily during such works. The Government shall have no liability in respect of any loss, damage, nuisance or disturbance whatsoever caused to or suffered by the Grantee or any person arising out of or incidental to the exercise by the authorised persons of the rights conferred under this Special Condition. No claim shall be made against the Government or the authorized persons in respect of any loss, damage, nuisance or disturbance arising out of any action under this sub-clause.
19. Special Condition No. (43) of the Land Grant stipulates that:-
- (a) The Grantee acknowledges that there is an existing storm water drain running across, through or under the lot as shown by a blue line on PLAN I annexed to the Land Grant. The Grantee shall at his own expense within such time, in such manner, with such materials and to such standards, specifications, levels and design as the Director shall approve or require and in all respects to the satisfaction of the Director divert the existing storm water drain to such other location as may be approved by the Director together with the provision, laying and construction of such drains, culverts, manholes with covers, access and other structures as the Director at his sole discretion may require (the diverted storm water drain and such drains, culverts, manholes with covers, access and other structures are hereinafter collectively referred to as the **"New Drainage"**).
- (b) In the event of the non-fulfilment of the Grantee's obligations under sub-clause (a) of this Special Condition, the Government may carry out the necessary works at the cost of the Grantee who shall pay to the Government on demand a sum equal to the cost thereof, such sum to be determined by the Director whose determination shall be final and shall be binding upon the Grantee. For the purpose of carrying out the works aforesaid, the Government, its officers, agents, contractors, workmen or other duly authorized personnel shall have the free and uninterrupted right at all times to enter into the lot or any part thereof and any building or buildings erected or to be erected thereon. The Government, its officers, agents, contractors, workmen or other duly authorized personnel shall have no liability in respect of any loss, damage, nuisance or disturbance whatsoever caused to or suffered by the Grantee or any other person arising out of or incidental to the exercise by it or them of the rights of entry and carrying out of the works conferred under this sub-clause, and no claim shall be made against it or them by the Grantee in respect of any loss, damage, nuisance or disturbance.
- (c) The Grantee shall at all times throughout the term hereby agreed to be granted permit the Government, its officers, contractors, workmen or any other duly authorized persons with or without motor vehicles, plant, tools, equipment and machinery the free rights of:
- (i) carrying out inspection, installation, repair, maintenance and renewal works in respect of the New Drainage or such other works as the Director may require; and
- (ii) ingress, egress and regress to and from and through the Green Areas, the Brown Areas, the Green Hatched Black Areas and the lot or any part thereof for the purposes of sub-clause (c)(i) of this Special Condition.
- (d) The Government, its officers, contractors, workmen and any other duly authorized personnel shall have no liability in respect of any loss, damage, nuisance or disturbance whatsoever caused to or suffered by the Grantee arising out of or incidental to the exercise of the rights conferred under sub-clause (c) of this Special Condition and no claim shall be made against it or them in respect of any such loss, damage, nuisance or disturbance.
- (e) Upon completion of the New Drainage, the Combined Utilities and Drainage Reserve as defined in Special Condition No. (40) of the Land Grant shall be deemed to include additionally an area of 6-metre in width along the alignment of the New Drainage.
20. Special Condition No. (44) of the Land Grant stipulates that:-
- (a) The Grantee shall construct and maintain at his own expense and to the satisfaction of the Director such drains and channels, whether within the boundaries of the lot or on Government land, as the Director may consider necessary to intercept and convey into the nearest stream-course, catchpit, channel or Government storm-water drain all storm-water or rain-water falling or flowing on to the lot, and the Grantee shall be solely liable for and shall indemnify the Government and its officers from and against all actions, claims and demands arising out of any damage or nuisance caused by such storm-water or rain-water.
- (b) The drainage of any building or buildings erected or to be erected on the lot shall be effected as may be required by the Director, and the Grantee shall make all arrangements at his own expense and to the satisfaction of the Director for the treatment and disposal of foul or contaminated water by the construction, operation and maintenance of suitable works either within the lot or on Government land or otherwise and on such terms as the Director shall require, and the Grantee shall be solely liable for any damage or nuisance caused thereby. Subject to there being in existence Government sewerage connection which in the opinion of the Director is suitable for connection to the lot, the Grantee shall construct and maintain at his own expense and to the satisfaction of the Director such suitable works for connecting the drainage of any building or buildings erected or to be erected on the lot.
- (c) The works of connecting any drains and sewers from the lot to the Government storm-water drains and sewers, when laid and commissioned, may be carried out by the Director who shall not be liable to the Grantee for any loss or damage thereby occasioned and the Grantee shall pay to the Government on demand the cost of such connection works. Alternatively, the said connection works may be carried out by the Grantee at his own expense to the satisfaction of the Director and in such case any section of the said connection works which is constructed within Government land shall be maintained by the Grantee at his own cost and upon demand be handed over by the Grantee to the Government for future maintenance thereof at the expense of the Government and the Grantee shall pay to the Government on demand the cost of the technical audit in respect of the said connection works. The Director may, upon failure of the Grantee to maintain any section of the said connection works which is constructed within Government land, carry out such maintenance works as he considers necessary and the Grantee shall pay to the Government on demand the cost of such works.

批地文件的摘要

21. Special Condition No. (45) of the Land Grant stipulates that:-

- (a) No grave, "Pak Kung" or "Kam Tap" presently existing on the lot or any part thereof or on any Government land adjacent thereto shall be interfered with or removed without the prior written approval of the Director.
- (b) Subject to the written approval of the Director under sub-clause (a) of this Special Condition, the Grantee shall at his own expense and to the satisfaction of the Director remove such grave, "Pak Kung" or "Kam Tap" and comply with the requirement of the Director in respect of the removal works. The Grantee hereby indemnifies and shall keep indemnified the Government and the Director from and against all actions, suits, costs, claims for compensation (including "Tun Fu" ceremonies) and demands whatsoever arising out of or incidental to the removal of or damage to any grave, "Pak Kung" or "Kam Tap".
- (c) Except for the graves, "Pak Kung" or "Kam Tap" presently existing on the lot as mentioned in sub-clause (a) of this Special Condition, no grave or columbarium shall be erected or made on the lot, nor shall any human remains or animal remains whether in earthenware jars, cinerary urns or otherwise be interred therein or deposited thereon.

Note : For full details, please refer to the Land Grant. Full script of the Land Grant is available for free inspection upon request at the sales office during opening hours and copies of the Land Grant can be obtained upon paying necessary photocopying charges.

批地文件的摘要

- 「發展項目」建於丈量約份第227約地段第898號(「**該地段**」)，根據「新批地文件」第21303號(「**批地文件**」)持有。
- 「**該地段**」的批租年期為50年，2011年10月13日開始生效。
- 「**批地文件**」第(5)條批地特別條款訂明：
 - 「**承批人**」應：
 - 在「**批地文件**」生效日後84個曆月內或地政總署署長(「**署長**」)批准的其他延長期限，自費以「**署長**」批准的方式及物料、標準、樓層、走線和設計進行下列工程，以全面令「**署長**」滿意：
 - 在「**批地文件**」所夾附「**圖則I**」以綠色顯示的日後興建公共道路範圍(以下統稱「**綠色範圍**」)進行鋪設及平整工程；及
 - 提供和建造「**署長**」全權酌情為必要的橋、隧道、上跨路、下通道、下水道、高架道路、天橋、行人路、道路或其他構築物(以下統稱「**構築物**」)；

以便在「**綠色範圍**」建造建築物和供車輛及行人往來。
 - 於「**批地文件**」生效日後84個曆月內或「**署長**」批准的其他延長期限，自費以「**署長**」滿意的方式在「**綠色範圍**」鋪設表面、建造路緣及渠道，並且按「**署長**」要求為此等設施提供溝渠、污水管、排水渠、消防栓連接駁總水管的水管、街燈、交通標誌、街道設施及道路標記；及
 - 自費維修「**綠色範圍**」及「**構築物**」和在該處建造、安裝及提供之所有構築物、表面、溝渠、污水管、排水渠、消防栓、服務設施、街燈、交通標誌、街道設施、道路標記及機器，以令「**署長**」滿意，直至「**綠色範圍**」的估管權按照「**批地文件**」第(6)條批地特別條款交回「**政府**」為止。
- 「**批地文件**」第(9)(a)條批地特別條款訂明：

「**承批人**」於「**批地文件**」生效日後84個曆月內，自費以「**署長**」指定或批准的方式及物料、標準、樓層、走線和規格，以全面令「**署長**」滿意的方式在「**批地文件**」所夾附「**圖則I**」以粉紅色加黑點間紅斜線及粉紅色加黑點間黑斜線間紅斜線顯示的範圍或「**署長**」書面批准的其他地方提供和建造一條設有行人路的鋪築道路，連同相關的街道設施、交通輔助設施、街燈、污水管、排水渠及其他構築物(以下統稱「**緊急車輛通道**」)。
- 「**批地文件**」第(9)(c)條批地特別條款訂明：

「**承批人**」於本文協定的整個批租年期內，自費保養、維修和修理「**緊急車輛通道**」及附屬或從屬於該處的所有物件，以保持其清潔整齊、不受阻礙和維修充足及狀態良好，以令「**署長**」滿意。如「**承批人**」不如上保養、維修及修理「**緊急車輛通道**」，「**政府**」、「**署長**」或其授權的任何人士或人等可依法在「**署長**」視為恰當的時期內安排「**緊急車輛通道**」的清潔、整理或修理等工程，費用由「**承批人**」承擔。「**承批人**」須在「**政府**」通知時向「**政府**」支付相等於工程費用的款項，有關金額由「**署長**」釐定，而其決定將作終論並對「**承批人**」約束。
- 「**批地文件**」第(10)條批地特別條款訂明：

「**承批人**」應發展該地段，即全面遵照此等「**批地條款**」及於任何時間在香港生效的所有建築、衛生及規劃「**條例**」、附例及規例，在該處建造一座或多座建築物。此等建築物於2018年12月31日或之前建成並適宜佔用居住。
- 「**批地文件**」第(11)條批地特別條款訂明：

該地段或其任何部份或現已或將會建於該處之任何一座或多座建築物，除作非工業用途外(不包括酒店、加油站及貨倉)，不可作任何其他用途。
- 「**批地文件**」第(12)條批地特別條款訂明：

如非事前獲「**署長**」書面同意，而「**署長**」給予同意時可附加其視為恰當的移植、補償園景工程或再植條件，概不可移除或干預任何現於該地段或毗連土地生長的樹木。
- 「**批地文件**」第(13)條批地特別條款訂明：
 - 「**承批人**」應提交或達致提交園景美化設計總圖予規劃署署長，述明該地段之園景美化建議，以供審批。
 - 園景美化設計總圖比例應為1：500或更大，並須載明園景美化建議資料，包括現有樹木普查及處理方案、地盤平面圖和平整面標高、房屋發展概念模式、園景建築工程區及花卉樹木種植工程區圖解布局，以及規劃署署長指定的其他資料。「**批地文件**」第(12)條批地特別條款訂明的樹木保育建議取得同意書(如需要者)之前，不可在該地段或其任何部份展開任何地盤平整工程。
 - 如該地段進行發展或重建，「**承批人**」應自費按照經批核的園景美化設計總圖在該地段進行園景美化，如非事前獲「**署長**」書面同意，不得作任何修改、更改、改動、變更或取代。
 - 「**承批人**」應在本文協定的整個批租年期內自費遵照本批地特別條款(c)款規定保養和維修園景美化工程，以維持其安全、清潔、整齊、實用及健康，全面令「**署長**」滿意。

批地文件的摘要

10. 「批地文件」第(16)條批地特別條款訂明：

- (a) 「承批人」可在該地段內興建、建造和提供經「署長」書面批准的康樂設施及該處之附屬設施(以下簡稱「設施」)。「設施」的類型、大小、設計、高度及布局必須事前向「署長」申請書面批准。
- (b) 為計算「批地文件」第(14)(c)及(14)(f)條批地特別條款分別訂明的總樓面面積和總上蓋面積，遵照本批地特別條款(a)款規定在該地段範圍內提供的「設施」任何部份如供現已或將會建於該地段一座或多座住宅大樓全體居民及彼等之真正訪客公用與共享，一律不計算在內。「署長」認為並非作上述用途的「設施」其餘部份則會計算在內。
- (c) 如「設施」任何部份可豁免計入根據本批地特別條款(b)款所訂的總樓面面積及上蓋面積(以下簡稱「豁免設施」)：
 - (i) 「豁免設施」應劃為並構成「批地文件」第(23)(a)(v)條批地特別條款所載的「公用地方」；
 - (ii) 「承批人」應自費維修「豁免設施」，以保持其維修充足及狀態良好，同時以「署長」滿意的方式運作「豁免設施」；及
 - (iii) 「豁免設施」只可供現已或將會建於該地段的一座或多座住宅大樓全體居民及彼等的真正訪客使用，其他人士或人等一概不可使用。

11. 「批地文件」第(27)條批地特別條款訂明：

- (a) 「住宅停車位」(釋義以「批地文件」所訂為準)不可：
 - (i) 轉讓，除非：
 - (I) 連同賦予專有權使用及佔用現已或將會建於該地段一座或多座建築物的一個或多個住宅單位之不可分割份數一併轉讓；或
 - (II) 承讓人現時已擁有具專有權使用及佔用現已或將會建於該地段一座或多座建築物的一個或多個住宅單位之不可分割份數；或
 - (ii) 分租(租予現已或將會建於該地段一座或多座建築物內住宅單位的居民除外)。

於任何情況下，現已或將會建於該地段一座或多座建築物內任何一個住宅單位的業主或居民概不可承讓或承租多於三(3)個「住宅停車位」。

12. 「批地文件」第(32)條批地特別條款訂明：

- (a) 該地段批出時附帶一項權利，「承批人」、其傭僕、訪客、工人及其就此授權的其他人等可不時及隨時於本文協定批授的整個批租年期內就完善使用及享用該地段的所有相關事宜，於「署長」批准的水平通行、再通行、進出及往返「批地文件」所夾「圖則I」以棕色顯示各地方(以下統稱「棕色範圍」)。
- (b) 「承批人」應在該地段任何建造工程動工之前(不包括平整工程)或「署長」指定的期限內，自費以「署長」指定的方式及物料，按「署長」要求或批准的標準，在「棕色範圍」及沿本批地特別條款(a)款所載的通道建造有鋪築路面的道路，連同相關的街道設施、交通輔助設施、街燈、污水管、排水渠及其他構築物。
- (c) 「承批人」應自費以「署長」滿意的方式保養、維修和修理「棕色範圍」及附屬或從屬於該處的所有物件，並須就「棕色範圍」承擔全責，猶如其乃「棕色範圍」的絕對業主。
- (d) 倘任何公共道路進行更改工程，以致吸納「棕色範圍」任何可作通道的部份或影響其坡度，「承批人」概不可提出任何索償。「承批人」應自費以「署長」滿意的方式，在其建造的鋪築路面道路進行相應的更改工程。
- (e) 本批地特別條款(a)款所載的通行權概不賦予「承批人」「棕色範圍」的專用權。「政府」保留權利將「棕色範圍」的通行權授予現時或日後位於附近的任何其他地段之業主，或接管「棕色範圍」整體或當中任何部份作公共街道，而毋須向「承批人」或其他獲授予「棕色範圍」整體或當中任何部份通行權的其他業主支付任何補償。
- (f) 如「承批人」不履行本批地特別條款(b)及(c)款訂明的責任，「政府」可執行必要的建造、維修及修理工程，費用則由「承批人」承擔。「承批人」須在「政府」通知時支付相等於有關費用的款項，金額由「署長」指定，而其決定將作終論並對「承批人」約束。
- (g) 儘管授予本批地特別條款(a)款所載的通行權，「政府」仍有全權及權力向「承批人」發出不少於十四(14)天事前書面通知(緊急情況除外)後，按「署長」自行酌情為恰當，鋪設、安裝、重鋪、改道分流、拆除、重置、更換、檢查、運作、修理、維修及更新現時或此後任何時間位於「棕色範圍」上、下或毗鄰該處的任何「政府」或其他排水渠、下水道、水道或渠道、污水管、明渠、總水管、水管、電纜、電線、管線、公用事業設施或其他工程或裝置(以下統稱「服務」)，如造成任何損害則妥善修葺。「署長」、其官員、承辦商及任何其他獲其授權人等、彼等之工人時刻均有權攜帶工具、設備、機器、機械或駕車與否自由出入及再出入「棕色範圍」，以作上述用途。如非事前獲「署長」書面批准，「承批人」不可干擾或允許他人干擾服務。除修復任何及所有因其行使上述權利及權力導致的損害外，「政府」、其「署長」、官員、承辦商及任何其他獲其授權人等及彼等之工人均毋須就行使本款所訂權利所招致或連帶引起的損失、損害、滋擾或騷擾承擔責任。「承批人」概不可對彼等提出索償或異議。

批地文件的摘要

13. 「批地文件」第(33)條批地特別條款訂明：

- (a) (i) 茲「政府」獲例外保留現於「批地文件」所夾附「圖則I」以粉紅色加黑點間藍斜線顯示的該地段部份由高於香港主水平基準約105米至低於現有地面水平約0.5米的範圍(以下簡稱「地下岩層」)。「承批人」概無擁有、佔管或使用「地下岩層」的權利或業權，亦概不可就「地下岩層」索取任何賠償。於本批地特別條款，「署長」就現有地面水平定義所作的決定將作終論並對「承批人」約束。
- (ii) 「政府」、其人員、承租人、租客、受許可人或授權人等並獲例外保留不受限制的權利和自由權，可於本文協定的整個批租年期內，以「政府」視為恰當的方式在「地下岩層」內建造、安裝、運作、維修、修理及更新污水管系統，以供「政府」視為恰當的人等使用。
- (b) 「政府」、其人員、承租人、租客、受許可人或授權人等和「地下岩層」或其任何部份現任業主及佔用人，毋須繳付任何款項，即可自由及暢通無阻地行使現獲例外保留的下列權利：
- (i) 擁有所有必要的地役權及特權，包括但不限於該地段對需要庇護、支撐及保護的「地下岩層」任何部份提供庇護、支撐及保護。有關的「地下岩層」部份由「署長」界定，其決定將作終論並對「承批人」約束；
- (ii) 有權時刻不論駕車、攜帶機器、工具、設備及機械與否，通行「綠色範圍」、「棕色範圍」、該地段或其任何部份或現已或將會建於該處任何一座或多座建築物，以便自由進出及往返「地下岩層」進行本批地特別條款(a)(ii)款訂明的事項；及
- (iii) 有權按「署長」要求在「地下岩層」內進行任何建造、安裝、維修、修理、更新、檢查、重鋪及改道工程或任何其他工程。
- (c) 「承批人」應時刻採取或達致他人採取所有完善適當的護理、工藝及預防措施，特別以進行建造、維修、更新或更換工程時為要，以避免對「地下岩層」或該處的污水管系統造成任何損害、滋擾或阻礙。如工程對「地下岩層」或該處的污水管系統造成任何損害、滋擾或阻礙，「承批人」應自費修理、修復及還原，以令「署長」滿意。如「承批人」不按需要修理、修復及還原「地下岩層」或其任何部份或該處之污水管系統以令「署長」滿意，「署長」可按其視為必要執行此等修理、修復或還原工程，並於「署長」通知時支付有關工程的費用，金額由「署長」釐定，而「署長」的決定將作終論其對「承批人」約束。倘因「承批人」損害、滋擾或阻礙「地下岩層」或該處的污水管系統導致任何私人財產受損或干擾，以致引起任何法律行動、訴訟、損失、損害、開支、索償及索求，「承批人」現向「政府」賠償並確保彼等免責。
- (d) 「政府」、其人員、承租人、租客、受許可人或授權人等概毋須就因「地下岩層」及該處污水管系統的建造、存在或運作又或因行使本批地特別條款賦予彼等權利而令「承批人」招致或附帶蒙受的損失、損害、滋擾或騷擾承擔任何責任。「承批人」不可就此向「政府」、其人員、承租人、租客、受許可人或授權人等索償。

14. 「批地文件」第(34)條批地特別條款訂明：

- (a) 「承批人」確認該地段由「批地文件」所夾附「圖則I」顯示及標記A點的西面邊界位置到東面邊界註明為FP的位置現有一條行人道橫越(以下簡稱「現有行人道」)。「承批人」應在「署長」指定的期限內及遵從「署長」訂明的條件或規定，自費以「署長」批准或指定的水平、走線、方式、物料、設計、標準及規格，於現有行人道進行更換工程，以建造和完成建造「署長」滿意的新行人道(以下簡稱「行人道」)，連接「批地文件」所夾附「圖則I」顯示並註明的A點及B點。為免存疑，「承批人」如非事前獲「署長」書面批准，不得拆卸、關閉現有行人道或其任何部份或安排改道。
- (b) 於本文協定的整個批租年期內，只要現有行人道尚未關閉，「承批人」時刻均應允許「政府」、其人員或授權人等及任何公眾免費通行、行經及往返現有行人道及「行人道」，以作任何合法用途。
- (c) 於本文協定的整個批租年期內，「承批人」須自費管理、維修和修理尚未關閉的現有行人道及「行人道」，以保持其維修充足及狀態良好，全面令「署長」滿意。
- (d) 倘因以下情況導致「政府」及「署長」招致任何性質的責任、訴訟、法律程序、費用、索償、開支、損失、損害、收費及索求，「承批人」現向「政府」及「署長」賠償並確保彼等免責：
- (i) 「承批人」、其代理、工人及承辦商就管理、維修或修理尚未關閉的現有行人道或「行人道」作出或漏作的行為；
- (ii) 現有行人道或其任何部份拆卸、關閉或改道；或
- (iii) 建造「行人道」。
- (e) 現明確協議及聲明，儘管「承批人」須承擔本批地特別條款(b)款訂明的責任，「承批人」並無意向而「政府」並未同意將尚未關閉的現有行人道或其任何部份、「行人道」或其任何部份或該地段部份劃為公眾有權通行的範圍。
- (f) 現明確協議及聲明，儘管本批地特別條款(b)款訂明「承批人」須承擔責任，「承批人」概不可因此預期或索償任何特許權，或關於額外上蓋面積或地積比率的權利，不論是否根據《建築物(規劃)規例》第22(1)條、其任何修訂條文或取代條文等亦然。為免存疑，「承批人」現明確豁免任何及所有關乎《建築物(規劃)規例》第22(1)條、其任何修訂條文或取代條文所訂額外上蓋面積或地積比率之特許權的申索或相關權利。
- (g) 如「承批人」不履行本批地特別條款(a)及(c)款所訂的責任，「政府」可執行必要的建造、維修或修理工程，費用由「承批人」承擔。「承批人」須在接獲通知時向「政府」支付相等於工程費用的款項，金額由「署長」釐定，其決定將作終論並對「承批人」約束。為執行上述工程，「政府」、其人員、代理、承辦商、工人或其他正式獲授權人員均擁有自由及不受阻礙的權利，可於任何合理時間進入該地段或其任何部份和現已或將會建於該處任何一座或多座建築物。倘因「政府」、其人員、代理、承辦商、工人或其他正式獲授權人員行使本款所訂權利而令「承批人」蒙受或連帶招致任何損失、損害、滋擾或騷擾，「政府」、其人員、代理、承辦商、工人或其他正式獲授權人員概毋須就此承擔責任，「承批人」不得就此等損失、損害、滋擾或騷擾向彼等或當中任何一方索償。

批地文件的摘要

15. 「批地文件」第(36)條批地特別條款訂明：

- (a) 如該地段或任何「政府」官地現時或以往曾經配合或因應該地段或其任何部份的平整、水準測量或發展事宜進行削土、移土或土地後移工程，或建造或填土工程，或任何性質的斜坡處理工程，或此等「批地條款」規定「承批人」執行的其他工程，不論事前是否獲「署長」書面同意，「承批人」亦須於當時或嗣後任何時間，按需要自費進行及建造斜坡處理工程、護土牆或其他支承防護結構、排水或附屬或其他工程，以保護和支撐該地段內的土地以及任何毗連或毗鄰「政府」官地或已批租土地，同時避免及防止其後發生滑土、山泥傾瀉或地陷。「承批人」應時刻在本文協定的整個批租年期內自費維修上述土地、斜坡處理工程、護土牆或其他支承防護結構、排水、輔助工程或其他工程，以保持其維修充足及狀態良好，令「署長」滿意。
- (b) 本批地特別條款(a)款之規定概毋損此等「批地條款」賦予「政府」的各項權利，其中特別以「批地文件」第(35)條批地特別條款所訂者為要。
- (c) 無論何時如因「承批人」執行的平整、水準測量、發展事宜或其他工程或任何其他事故導致或引致滑土、山泥傾瀉或地陷，不論是源於該地段範圍內任何土地或毗鄰或毗連「政府」官地或批租土地，「承批人」亦須自費還原及修復以令「署長」滿意，並向「政府」、其代理及承辦商作出賠償所有由此引起、招致或蒙受的費用、收費、損害、索求及索償。
- (d) 「署長」除可就此等「批地條款」的違約事件行使本文訂明的任何其他權利或補償權外，並有權發出書面通知要求「承批人」進行、建造及維修上述土地、斜坡處理工程、護土牆或其他支承防護結構、排水或附屬或其他工程，又或還原及修復任何土地滑土、山泥傾瀉或地陷；又或如「承批人」疏忽或不按照通知於通知指定期限內以「署長」滿意的方式採取措施，「署長」可即時執行及進行任何必要工程，「承批人」須在「政府」通知時償付相關的費用，以及任何行政或專業費用與收費。

16. 「批地文件」第(37)條批地特別條款訂明：

- (a) 「承批人」應依照「署長」全權酌情指定，自費以「署長」全面滿意的方式在「批地文件」所夾附「圖則I」以綠色間黑斜線顯示的範圍(以下簡稱「綠色間黑斜線範圍」)進行及完成土力勘探工程和斜坡處理、山泥傾瀉預防、減緩及補救工程。此外，「承批人」並須在本文協定的整個批租年期內，自費以「署長」滿意的方式維修「綠色間黑斜線範圍」，以保持其維修充足及狀態良好，包括在該處執行所有土地、斜坡處理工程、護土結構、排水及其他工程。倘於本文協定的批租年期內任何時間「綠色間黑斜線範圍」發生山泥傾瀉、地陷或滑土，「承批人」須以「署長」滿意的方式自費還原及修復「綠色間黑斜線範圍」和「署長」認為(其決定將作終論並對「承批人」約束)同樣受影響的任何毗連或毗鄰地方。如因山泥傾瀉、地陷或滑土招致或引起任何索償、訴訟、費用、損害及開支，「承批人」須向「政府」、其代理及承辦商作出賠償。此外，「承批人」並須時刻確保無任何人等在「綠色間黑斜線範圍」非法挖掘或傾倒廢物。如事前獲「署長」書面批准，「承批人」可架設圍欄或其他屏障防止非法挖掘或傾倒廢物的活動。倘有違反「批地條款」的情況，「署長」除可行使任何其他應有權利或補償權外，並可隨時以書面通知「承批人」執行任何土力勘探工及斜坡處理、山泥傾瀉預防、減緩及補救工程，並且維修、還原和修復任何受山泥傾瀉、地陷或滑土影響的土地、構築物或工程。倘「承批人」疏忽或不按照通知在通知指定期限內以「署長」滿意的方式採取措施，「署長」可即時執行及進行任何必要工程，「承批人」須在「政府」通知時償付相關的費用。

- (b) 儘管有本批地特別條款(a)款之規定，如「政府」向「承批人」發出相關通知，本批地特別條款所訂「承批人」就「綠色間黑斜線範圍」或其任何部份擁有的責任及權利即絕對終止。如權責終止令「承批人」蒙受或招致任何損失、損害、滋擾或開支，「承批人」概不可向「政府」、「署長」或其授權的人員申索賠償。然而，權責終止概不妨礙「政府」就任何之前已發生的違反、不遵守或不履行前述(a)款規定事件行使任何應有的權利或補償權。

17. 「批地文件」第(39)條批地特別條款訂明：

如該地段的發展項目或重建項目或其任何部份已安裝預應力地錨樁基，「承批人」應在預應力地錨樁基的整個使用周期自費進行定期維修和定期監察，以令「署長」滿意，此外並須按「署長」不時全權酌情要求，提供所有監察工程的報告及資料。如「承批人」疏忽執行或不執行規定的監察工程，「署長」可即時開展及執行監察工程，「承批人」須在「政府」通知時向「政府」償付有關的費用。

18. 「批地文件」第(40)條批地特別條款訂明：

- (a) 除於「批地文件」所夾附「圖則I」以粉紅色加黑點間黑斜線間紅斜線顯示的範圍內根據「批地文件」第(9)條批地特別條款設置的「緊急車輛通道」外，不得在「批地文件」所夾附「圖則I」以粉紅色間黑斜線、粉紅色加黑點間黑斜線及粉紅色加黑點間黑斜線間紅斜線顯示的範圍(以下統稱「綜合公用服務及渠務專用範圍」)上、下、內或跨越該處搭建或建造任何建築物或構築物或任何建築物或構築物的地基或支承件。如事前獲「署長」書面批准，「綜合公用服務及渠務專用範圍」可改道或搬遷至該地段其他地方。
- (b) 「政府」、其人員、工人、承辦商或代理(以下統稱「獲授權人等」)時刻均有不受限制的權利，攜帶工具、設備、機器或駕車與否進出或再返回及行經該地段，以鋪設、修理、維修、檢查及更新「綜合公用服務及渠務專用範圍」內、下或貫越該處的任何排水渠、污水管、水渠、渠務設施、供水及其他服務，並可在施工期間暫時關閉「綜合公用服務及渠務專用範圍」。倘若因為或鑒於獲授權人等行使本批地特別條款賦予的權利而使「承批人」或任何人士蒙受或連帶招致任何損失、損害、滋擾或騷擾，「政府」概毋須就此承擔責任，「承批人」亦不可就本款所載任何行動引致的損失、損害、滋擾或騷擾向「政府」或獲授權人等提出索償。

19. 「批地文件」第(43)條批地特別條款訂明：

- (a) 「承批人」確認於該地段現時有一條雨水渠跨越或貫越「批地文件」所夾附「圖則I」以藍線顯示的位置或鋪設於該處地下。「承批人」應在「署長」指定的期限內自費以「署長」批准或指定的方式、物料、標準、規格、水平及設計，將現有雨水渠改道至「署長」批准的其他位置，以全面令「署長」滿意，此外並要提供、鋪設及建造「署長」全權酌情指定的排水渠、下水道、有蓋沙井、出入通道及其他構築物(改道的雨水渠及此等排水渠、下水道、有蓋沙井、出入通道及其他構築物以下統稱「新渠務裝置」)。

批地文件的摘要

- (b) 如「承批人」不履行本批地特別條款(a)款所訂的責任，「政府」可執行必要的工程，費用由「承批人」承擔。「承批人」須在接獲通知時向「政府」支付相等於工程費用的款項，金額由「署長」釐定，其決定將作終論並對「承批人」約束。為執行上述工程，「政府」、其人員、代理、承辦商、工人或其他正式獲授權人員均擁有自由及不受阻礙的權利，可於任何時間進入該地段或其任何部份和現已或將會建於該處任何一座或多座建築物。倘因「政府」、其人員、代理、承辦商、工人或其他正式獲授權人員行使本款所訂權利及執行本款授權的工程而令「承批人」或其他人士蒙受或連帶招致任何損失、損害、滋擾或騷擾，「政府」、其人員、代理、承辦商、工人或其他正式獲授權人員概毋須就此承擔責任，「承批人」不得就此等損失、損害、滋擾或騷擾向彼等或當中任何一方索償。
- (c) 「承批人」應在本文協定的整個批租年期內時刻允許「政府」、其人員、承辦商、工人或其他獲授權人等，駕車或攜帶機器、工具、設備及機械與否，自由行使以下權利：
- (i) 執行「新渠務裝置」的檢查、安裝、修理、維修及更新工程或「署長」規定的其他工程；及
- (ii) 通行、進出及往返「綠色範圍」、「棕色範圍」、「綠色間黑斜線範圍」及該地段或其任何部份，以執行本批地特別條款(c)(i)款所載的事宜。
- (d) 倘因行使本批地特別條款(c)款所訂權利而導致「承批人」蒙受或連帶招致任何損失、損害、滋擾或騷擾，「政府」、其人員、承辦商、工人或其他正式獲授權人員概毋須就此承擔責任，「承批人」不得就此等損失、損害、滋擾或騷擾向彼等或當中任何一方索償。
- (e) 「新渠務裝置」建成後，「批地文件」第(40)條批地特別條款載明釋義的「綜合公用服務及渠務專用範圍」將被視為另加額外範圍，即沿「新渠務裝置」走線闊6米的地方。

20. 「批地文件」第(44)條批地特別條款訂明：

- (a) 「承批人」應自費以「署長」滿意的方式在該地段邊界範圍內或「政府」官地建造及維修「署長」視為必要的排水渠及水渠，以截流和引流所有降於或流入該地段的暴雨或雨水，排放至附近的河溪、集水井、水道或「政府」雨水渠。如因上述暴雨或雨水造成損害或滋擾以致引起任何訴訟、索償及索求，「承批人」必須承擔責任並向「政府」及其人員賠償。
- (b) 現已或將會建於該地段的任何一座或多座建築物的排水裝置應按「署長」規定的方式裝設，「承批人」須自費作出所有安排，在該地段內或「政府」官地等建造、運作及維修適當工程，以「署長」滿意的方式及按「署長」指定的條款規定處理和處置廢水或污水，如因此造成任何損害或滋擾，「承批人」須獨自承擔全責。如現時已有「署長」認為適合接駁至該地段的「政府」污水接駁系統，「承批人」須自費以「署長」滿意的方式建造和維修適當的工程，以接駁排水裝置至現已或將會建於該地段的任何一座或多座建築物。
- (c) 接駁該地段任何排水渠及污水管至已鋪妥啟用的「政府」雨水渠及污水管的工程，將由「署長」執行，但倘因施工令「承批人」招致任何損失或損害，「署長」概不承擔責任，「承批人」並須在「政府」通知時向「政府」支付接駁工程的費用。此外，上述接駁工程亦可由「承批人」自費以「署長」滿意的方式執行。於該情況下，任何建於「政府」官地的上述接駁工程段落將由「承批人」自費維修。如「政府」發出通知，「承批人」須將此等工程段落移交「政府」，日後由「政府」自費維修，惟「承批人」須在「政府」通知時向「政府」支付上述接駁工程的技術審核費用。如「承批人」不維修上述建於「政府」官地的接駁工程段落，「署長」可按其視為必要執行維修工程。「承批人」須在「政府」通知時支付工程費用。

21. 「批地文件」第(45)條批地特別條款訂明：

- (a) 如非事前獲「署長」書面批准，不得干預或移除該地段或其任何部份或任何毗鄰「政府」土地上現存的墳墓、伯公或金塔。
- (b) 如獲「署長」根據本批地特別條款(a)款給予書面批准，「承批人」可自費以「署長」滿意的方式拆除此等墳墓、伯公或金塔，惟拆卸工程必須符合「署長」的要求。倘因拆卸損壞任何墳墓、伯公或金塔引起或招致任何訴訟、涉訟、費用、索償(包括躉符儀式)或索求，「承批人」現承諾向「政府」及「署長」賠償並確保彼等免責。
- (c) 除本批地特別條款(a)款所載該地段現存的墳墓、伯公或金塔外，該地段不得搭建或設置任何墳墓或骨灰龕，亦不可安葬或放置任何人類或動物遺體，不論屬陶泥金塔或骨灰盅等。

註：欲悉詳情請參考「批地文件」。「批地文件」全文已備於售樓處，歡迎在營業時間免費索取閱覽，並可支付必要的影印費用影印副本。

公共設施及公眾休憩用地的資料

A. Facilities that are required under the land grant to be constructed and provided for the Government, or for public use

1. Description
 - (a) The Green Area and the Structures as referred to in Special Condition No. (5) of the Land Grant (until their possession is re-delivered to the Government in accordance with the Land Grant).
 - (b) The Emergency Vehicular Access as referred to in Special Condition No. (9) of the Land Grant.
 - (c) The Footpath as referred in Special Condition No. (34) of the Land Grant.
2. The general public has the right to use the facilities in accordance with the Land Grant.

B. Facilities that are required under the land grant to be managed, operated or maintained for public use at the expense of the owners of the residential properties in the Development

1. Description
 - (a) The Green Area and the Structures as referred to in Special Condition No. (5) of the Land Grant (until possession thereof is re-delivered to the Government in accordance with the Land Grant).
 - (b) The Emergency Vehicular Access as referred to in Special Condition No. (9) of the Land Grant.
 - (c) The existing footpath as referred in Special Condition No. (34) of the Land Grant (until its closure in accordance with the Land Grant).
 - (d) The Footpath as referred in Special Condition No. (34) of the Land Grant.
2. The general public has the right to use the facilities in accordance with the Land Grant.
3. The facilities are required to be managed, operated or maintained at the expense of the owners of the residential properties in the Development.
4. The owners of the residential properties in the Development are required to meet a proportion of the expense of managing, operating or maintaining the facilities through the management expenses apportioned to the residential properties concerned.

C. Open space that is required under the land grant to be managed, operated or maintained for public use at the expense of the owners of the residential properties in the Development

Not applicable.

D. Any part of the land (on which the Development is situated) that is dedicated to the public for the purposes of regulation 22(1) of the Building (Planning) Regulations (Cap. 123 sub. Leg. F)

Not applicable.

E. A plan that shows the location of those facilities and open spaces, and those parts of the land

Please see the Plan I as annexed to the Land Grant which is reproduced in this section and the plan showing the Footpath.

F. Provisions of the land grant that concern those facilities and open spaces, and those parts of the land

- I. Special Condition No. (5) of the Land Grant stipulates that:-

“(a) The Grantee shall:

- (i) within 84 calendar months from the date of this Agreement or such other extended periods as may be approved by the Director; at his own expense, in such manner with such materials and to such standards, levels, alignment and design as the Director shall approve and in all respects to the satisfaction of the Director:
 - (I) lay and form those portions of future public roads shown coloured green on PLAN I annexed hereto (hereinafter collectively referred to as "the Green Areas"); and
 - (II) provide and construct such bridges, tunnels, overpasses, under-passes, culverts, viaducts, flyovers, pavements, roads or such other structures as the Director in his sole discretion may require (hereinafter collectively referred to as "the Structures")

so that building, vehicular and pedestrian traffic may be carried on the Green Areas.

- (ii) within 84 calendar months from the date of this Agreement or such other extended periods as may be approved by the Director; at his own expense and to the satisfaction of the Director; surface, kerb and channel the Green Areas and provide the same with such gullies, sewers, drains, fire hydrants with pipes connected to water mains, street lights, traffic signs, street furniture and road markings as the Director may require; and
- (iii) maintain at his own expense the Green Areas together with the Structures and all structures, surfaces, gullies, sewers, drains, fire hydrants, services, street lights, traffic signs, street furniture, road markings and plant constructed, installed and provided thereon or therein to the satisfaction of the Director until such time as possession of the Green Areas has been re-delivered to the Government in accordance with Special Condition No. (6) hereof.

- (b) In the event of the non-fulfilment of the Grantee's obligations under sub-clause (a) of this Special Condition within the prescribed period stated therein, the Government may carry out the necessary works at the cost of the Grantee who shall pay to the Government on demand a sum equal to the cost thereof, such sum to be determined by the Director whose determination shall be final and shall be binding upon the Grantee.

公共設施及公眾休憩用地的資料

(c) The Director shall have no liability in respect of any loss, damage, nuisance or disturbance whatsoever caused to or suffered by the Grantee or any other person whether arising out of or incidental to the fulfilment of the Grantee's obligations under sub-clause (a) of this Special Condition or the exercise of the rights by the Government under sub-clause (b) of this Special Condition or otherwise, and no claim for compensation, or otherwise shall be made against the Government or the Director or his authorized officers by the Grantee in respect of any such loss, damage, nuisance or disturbance."

2. Special Condition No. (6) of the Land Grant stipulates that:-

"For the purpose only of carrying out the necessary works specified in Special Condition No. (5) hereof, the Grantee shall on the date of this Agreement be granted possession of the Green Areas. The Green Areas shall be re-delivered to the Government on demand and in any event shall be deemed to have been re-delivered to the Government by the Grantee on the date of a letter from the Director indicating that these Conditions have been complied with to his satisfaction. The Grantee shall at all reasonable times while he is in possession of the Green Areas allow free access over and along the Green Areas for all Government and public vehicular and pedestrian traffic and shall ensure that such access shall not be interfered with or obstructed by the carrying out of the works whether under Special Condition No. (5) hereof or otherwise."

3. Special Condition No. (7) of the Land Grant stipulates that:-

"The Grantee shall not without the prior written consent of the Director use the Green Areas for the purpose of storage or for the erection of any temporary structure or for any purposes other than the carrying out of the works specified in Special Condition No. (5) hereof."

4. Special Condition No. (8) of the Land Grant stipulates that:-

"(a) The Grantee shall at all reasonable times while he is in the possession of the Green Areas:

- (i) permit the Director, his officers, contractors and any other persons authorized by him, the right of ingress, egress and regress to, from and through the lot and the Green Areas for the purpose of inspecting, checking and supervising any works to be carried out in compliance with Special Condition No. (5)(a) hereof and the carrying out, inspecting, checking and supervising of the works under Special Condition No. (5)(b) hereof and any other works which the Director may consider necessary in the Green Areas;
- (ii) permit the Government and the relevant public utility companies authorized by the Government the right of ingress, egress and regress to, from and through the lot and the Green Areas as the Government or the relevant public utility companies may require for the purpose of any works to be carried out in, upon or under the Green Areas or any adjoining land including but not limited to the laying and subsequent maintenance of all pipes, wire, conduits, cable-ducts and other conducting media and ancillary equipment necessary for the provision of telephone, electricity, gas (if any) and other services intended to serve the lot or any adjoining or neighbouring land or premises. The Grantee shall co-operate fully with the Government and also with the relevant public utility companies duly authorized by the Government on all matters relating to any of the aforesaid works to be carried out within the Green Areas; and
- (iii) permit the officers of the Water Authority and such other persons as may be authorized by them the right of ingress, egress and regress to from and through the lot and the Green Areas as the officers of the Water Authority or such authorized persons may require for the purpose of carrying out any works in relation to the operation, maintenance, repairing, replacement and alteration of any other waterworks installations within the Green Areas.

(b) The Government shall have no liability in respect of any loss, damage, nuisance or disturbance whatsoever caused to or suffered by the Grantee or any other person arising out of or incidental to the exercise of the rights by the Government, its officers, agents, contractors, and any other persons or public utility companies duly authorized under sub-clause (a) of this Special Condition."

5. Special Condition No. (9) of the Land Grant stipulates that:-

"(a) The Grantee shall within 84 calendar months from the date of this Agreement, at his own expense, in such manner with such materials and to such standards, levels, alignment and specifications as the Director shall require or approve and in all respects to the satisfaction of the Director, provide and construct a paved road with pavement and such associated street furniture, traffic aids, street lights, sewers, drains and other structures within the areas shown coloured pink stippled black hatched red and pink stippled black hatched black hatched red on PLAN I annexed hereto or within such other area or areas as may be approved in writing by the Director (hereinafter collectively referred to as "the Emergency Vehicular Access").

(b) The Grantee shall throughout the term hereby agreed to be granted permit the public, the Government, its officers, agents, workmen and any person authorized by the Government at all times and for all lawful purposes freely and without payment of any nature to pass and repass with or without motor vehicles, along, upon, by and through the Emergency Vehicular Access.

(c) The Grantee shall throughout the term hereby agreed to be granted at his own expense uphold, maintain and repair the Emergency Vehicular Access and everything forming a portion of or pertaining to it in a clean, tidy and unobstructed condition and in good and substantial repair to the satisfaction of the Director. In the event of the Emergency Vehicular Access not being so upheld, maintained and repaired, it shall be lawful for the Government, the Director or any person or persons authorized by him to make arrangements for the cleaning, tidying or repairing or otherwise in respect of the Emergency Vehicular Access for such period as the Director thinks fit at the cost of the Grantee who shall on demand pay to the Government a sum equal to the cost thereof, such sum to be determined by the Director whose determination shall be final and shall be binding upon the Grantee.

(d) In the event of the non-fulfilment of the Grantee's obligations under sub-clause (a) of this Special Condition within the prescribed period stated therein, the Government may carry out the necessary works at the cost of the Grantee who shall pay to the Government on demand a sum equal to the cost thereof, such sum to be determined by the Director whose determination shall be final and shall be binding upon the Grantee.

(e) The Government, its officers, agents, contractors, workmen or other authorized persons shall have no liability in respect of any loss, damage, nuisance or disturbance whatsoever caused to or suffered by the Grantee or any other person whether arising out of or incidental to the fulfilment of the Grantee's obligations under sub-clause (a) of this Special Condition or the exercise of the rights by the Government under sub-clauses (c) and (d) of this Special Condition or otherwise, and no claim for compensation or otherwise shall be made against the Government or the Director or his authorized officers by the Grantee in respect of any such loss, damage, nuisance or disturbance.

(f) It is hereby expressly agreed, declared and provided that by imposing the obligation on the part of the Grantee contained in sub-clause (b) of this Special Condition, neither the Grantee intends to dedicate nor the Government consents to any dedication of the emergency Vehicular Access to the public for the right of passage.

公共設施及公眾休憩用地的資料

- (g) It is expressly agreed and declared that the obligation on the part of the Grantee contained in sub-clause (b) of this Special Condition will give rise to no expectation of, or claim for or in respect of, any concession or right in respect of additional site coverage or plot ratio whether under Regulation 22(1) of the Building (Planning) Regulations, any amendment thereto, substitution therefor, or otherwise and for the avoidance of doubt the Grantee expressly waives any and all claims in respect of or for any concession in respect of, or right to, additional site coverage or plot ratio under Regulation 22(1) of the Building (Planning) Regulations, any amendment thereto or substitution therefor.”
6. Special Condition No. (34) of the Land Grant stipulates that:-
- “(a) The Grantee acknowledges that there is an existing footpath transversing the lot from the western boundary of the lot at point A shown and marked on PLAN I annexed hereto to the eastern boundary of the lot and annotated "FP" (hereinafter referred to as "the existing footpath"). The Grantee shall at his own expense, within such time limit and in compliance with such conditions or requirements as may be imposed by the Director, and to the satisfaction of the Director, replace the existing footpath by the construction and completion of a new footpath at such levels or alignments in such manner, with such materials and to such design, standard specifications as the Director may approve or require connecting the points A and B shown and marked on PLAN I annexed hereto (hereinafter referred to as "the Footpath"). For the avoidance of doubt, the Grantee shall not demolish, close or divert the existing footpath or any part thereof without the prior written approval of the Director.
- (b) At all times during the term hereby agreed to be granted, the Grantee shall permit the Government, its officers or authorized persons and all members of the public for all lawful purposes and without payment of any nature whatsoever to pass and repass on foot on, along, over by and through the existing footpath prior to its closure and the Footpath.
- (c) The Grantee shall throughout the term hereby agreed to be granted at his own expense manage maintain and repair the existing footpath prior to its closure and the Footpath in good and substantial repair and condition and in all respects to the satisfaction of the Director.
- (d) The Grantee hereby indemnifies and shall keep indemnified the Government and the Director from and against all liabilities and all actions, proceedings, costs, claims, expenses, losses, damages, charges and demands of whatsoever nature arising out of or in connection with:
- (i) anything done or omitted to be done by the Grantee, his agents, workmen and contractors in connection with the management, maintenance or repair of the existing footpath prior to its closure or the Footpath;
- (ii) the demolition, closure or diversion of the existing footpath or part thereof; or
- (iii) the construction of the Footpath.
- (e) It is hereby expressly agreed, declared and provided that by imposing the obligation on the part of the Grantee contained in sub-clause (b) of this Special Condition, neither the Grantee intends to dedicate nor the Government consents to any dedication of the existing footpath or part thereof prior to its closure or the Footpath or part thereof or part of the lot to the public for the right of passage.

- (f) It is expressly agreed and declared that the obligation on the part of the Grantee contained in sub-clause (b) of this Special Condition will give rise to no expectation of, or claim for or in respect of, any concession or right in respect of additional site coverage or plot ratio whether under Regulation 22(1) of the Building (Planning) Regulations, any amendment thereto, substitution therefor, or otherwise and for the avoidance of doubt the Grantee expressly waives any and all claims in respect of or for any concession in respect of, or right to, additional site coverage or plot ratio under Regulation 22(1) of the Building (Planning) Regulations, any amendment thereto or substitution therefor.
- (g) In the event of the non-fulfilment of the Grantee's obligation under sub-clauses (a) and (c) of this Special Condition, the Government may carry out the necessary construction, maintenance or repair works at the cost of the Grantee who shall pay to the Government on demand a sum equal to the cost thereof, such sum to be determined by the Director whose determination shall be final and binding upon the Grantee. For the purpose of carrying out the works aforesaid, the Government, its officers, agents, contractors, workmen or other duly authorized personnel shall have a free and uninterrupted right at an reasonable times to enter into the lot or any part thereof and any building or buildings erected or to be erected thereon. The Government, its officers, agent, contractors, workmen or other duly authorized personnel shall have no liability in respect of any loss, damage, nuisance or disturbance whatsoever caused to or suffered by the Grantee arising out of or incidental to the exercise by it or them of the rights conferred under this sub-clause, and no claim for compensation or otherwise shall be made against it or them by the Grantee in respect of such loss, damage, nuisance or disturbance.”

G. Provisions of every deed of mutual covenant in respect of the specified residential property that concern those facilities and open spaces, and those parts of the land

- I. Clause I.1 of the DMC stipulates that:-

“In this Deed the following expressions shall have the following meanings except where the context otherwise permits or requires :-

“Development Common Areas and Facilities” means:-

- (a) the Public EVA, the Footpath, the Greenery Areas (in so far as they form part of the Development Common Areas and Facilities), the Drainage Reserve, the Office for Watchmen and Caretakers and the Owners' Committee Office;
- (b) caretakers' quarters, corridors, driveway, emergency generator room, emergency vehicular access, fan rooms, fire service control rooms, fan rooms, landings, street fire hydrant pump room, pump rooms, rain storage tank, ramps, refuse storage and material recovery chamber, sewage treatment plant room, staircases, switch rooms, telecommunications and broadcasting equipment rooms, transformer rooms, cable accommodation and all associated facilities, unexcavated areas, master water meter rooms, water meter cabinets, street fire hydrant water tank, sprinkler control valve cabinet, water tanks; and
- (c) such areas and facilities of and in the Land and the Development intended for common use and benefit of the Development as a whole

which for the purposes of identification only are shown coloured Green, Green Hatched Black and Green Cross-Hatched Black on the plans annexed hereto,

公共設施及公眾休憩用地的資料

PROVIDED THAT where appropriate, if (i) any parts of the Development covered by paragraph (a) of the definition of “common parts” set out in section 2 of the Building Management Ordinance and/or (ii) any parts specified in the Schedule 1 to the Building Management Ordinance and included under paragraph (b) of the definition of “common parts” set out in section 2 of the Building Management Ordinance shall also be covered by the provisions hereinbefore provided, such parts shall be deemed to have been included as, and shall form part of, the Development Common Areas and Facilities,

but shall exclude the Estate Common Areas and Facilities, the Residential Common Areas and Facilities, the Residential Tower Common Areas and Facilities, the Residential Block Common Areas and Facilities, the Commercial Common Areas and Facilities and the Carpark Common Areas and Facilities;

“Footpath”

means the footpath provided in accordance with Special Condition No. (34) of the Government Grant at the Lower Ground Floor level and the Ground Floor level of the portions of the Land shown coloured Green and marked “FOOTPATH” on the plans annexed hereto;

“Government Grant”

means the Agreement and Conditions of Exchange registered in the Land Registry as New Grant No.21303 and as the same may be modified, amended, varied or supplemented from time to time;

“Green Area”

means the Green Area as referred to in Special Condition No.(5)(a)(i)(I) of the Government Grant and shown coloured Green on the plan marked “PLAN I” annexed to the Government Grant;

“Green Area Structures”

means the bridges, tunnels, over-passes, under-passes, culverts, viaducts, flyovers, pavements, roads or such other structures as the Director of Lands in his sole discretion may require referred to and defined as “the Structures” under Special Condition No.(5)(a)(i)(II) of the Government Grant;

“Public EVA”

means the paved road with pavement and such associated street furniture, traffic aids, street lights, sewers, drains and other structures provided and constructed in accordance with Special Condition No. (9)(a) of the Government Grant at the Ground Floor level of the portions of the Land shown coloured Pink Stippled Black Hatched Red and Pink Stippled Black Hatched Black Hatched Red on “PLAN I” annexed to the Government Grant, and for the purposes of identification only are shown coloured Green Cross-Hatched Black and marked “PUBLIC EVA” on the plans annexed hereto;”

2. Clause 4.6 of the DMC stipulates that:-

“The annual budget shall cover the Management Expenses for the Common Areas and Facilities, the Green Area, the Green Area Structures, the Green Hatched Black Area and the Brown Areas including without limiting the generality of the foregoing:-

...

(o) the cost of repairing, maintaining and managing the Green Area, the Green Area Structures, the Green Hatched Black Area, the Brown Areas, the Public EVA and the Footpath under this Deed and/or pursuant to the Government Grant.”

3. Clause 4.7 of the DMC stipulates that:-

“The annual budget shall be divided into the following parts:-

(a) The first part shall cover all expenditure which in the opinion of the Manager (whose decision shall be conclusive save for manifest error) is to be expended for the benefit of all Owners or required for the proper management of the Land and the Development, the Development Common Areas and Facilities, the Green Area, the Green Area Structures, the Green Hatched Black Area and the Brown Areas.

...”

4. Clause 5.2 of the DMC stipulates that:-

“Without limiting the generality of the other express powers of the Manager herein contained, the Manager shall have power:-

...

(j) To maintain, manage and repair the Green Area, the Green Area Structures, the Green Hatched Black Area, the Brown Areas, the Public EVA and the Footpath in accordance with this Deed and the Government Grant.”

5. Clause 10.12 of the DMC stipulates that:-

“Notwithstanding anything herein contained and until such time as possession of the Green Area shall be redelivered or deemed to have been redelivered to the Government in accordance with the Government Grant, the Manager shall be responsible for the maintenance of the Green Area and the Green Area Structures and all structures, surfaces, gullies, sewers, drains, fire hydrants, services, street lights, traffic signs, street furniture, road markings and plant constructed, installed and provided thereon or therein in accordance with Special Condition No. (5)(a)(iii) of the Government Grant and the Owners shall be responsible for the costs and expenses for the maintenance and repair of the Green Area, the Green Area Structures and other structures thereon or therein as if they were part of the Common Areas and Facilities.”

6. Clause 10.13 of the DMC stipulates that:-

“The Owners shall uphold, maintain and repair the Public EVA and everything forming a portion of or pertaining to it in a clean, tidy and unobstructed condition and in good and substantial repair to the satisfaction of the Director of Lands in accordance with Special Condition No.9(c) of the Government Grant.”

7. Clause 10.15 of the DMC stipulates that:-

“The Owners shall manage, maintain and repair the Footpath in good and substantial repair and condition and in all respects to the satisfaction of the Director of Lands in accordance with Special Condition No.34(c) of the Government Grant.”

公共設施及公眾休憩用地的資料

8. Paragraph 1 of Part B of the Second Schedule to the DMC stipulates that:-

"The following are the rights and privileges subject to which the Owner of each Undivided Share and the exclusive right to hold, use, occupy and enjoy his premises is held:-

...

(c) The right of way of the public, the Government, its officers, agents, workmen and any person authorized by the Government at all times and for all lawful purposes freely and without payment of any nature to pass and repass with or without motor vehicles, along, upon by and through the Public EVA;

(d) The right of way of the Government, its officers, or authorized persons and all members of the public for all lawful purposes and without payment of any nature whatsoever to pass and repass on foot on, along, over, by and through the Footpath;

..."

9. Clause 51 of the Third Schedule to the DMC stipulates that:-

"Except for the Public EVA, no building or structure or foundation or support for any building or structure shall be erected on, above, below or within the Drainage Reserve. Subject to the prior written approval of the Director of Lands, the Drainage Reserve may be diverted or relocated to such area or areas of the Land."

公共設施及公眾休憩用地的資料

A. 批地文件訂明為「政府」建造及提供或作公眾用途的設施

1. 說明

- (a) 「批地文件」第(5)條批地特別條款所載的「綠色範圍」及「構築物」(直至依照「批地文件」規定向「政府」交還佔管權為止)。
- (b) 「批地文件」第(9)條批地特別條款所載的「緊急車輛通道」。
- (c) 「批地文件」第(34)條批地特別條款所載的「行人道」。

2. 公眾有權依據「批地文件」規定使用各設施。

B. 批地文件訂明由「發展項目」住宅物業業主付費管理、運作或維修以作公眾用途的設施

1. 說明

- (a) 「批地文件」第(5)條批地特別條款所載的「綠色範圍」及「構築物」(直至依照「批地文件」規定向「政府」交還佔管權為止)。
- (b) 「批地文件」第(9)條批地特別條款所載的「緊急車輛通道」。
- (c) 「批地文件」第(34)條批地特別條款所載的現有行人道(直至依照「批地文件」規定關閉為止)。
- (d) 「批地文件」第(34)條批地特別條款所載的「行人道」。

2. 公眾有權依據「批地文件」規定使用各設施。

3. 各設施由「發展項目」住宅物業的業主付費管理、營運或維修。

4. 「發展項目」住宅物業的業主應透過支付有關住宅物業應佔的管理開支，按比例分擔各設施的管理、運作或維修費用。

C. 批地文件訂明由「發展項目」住宅物業業主付費管理、運作或維修作公眾用途的休憩用地

不適用。

D. 劃供公眾作《建築物(規劃)條例》(香港法例第123章附例F)第22(1)條所訂用途的該土地(「發展項目」所在土地)任何部份：

不適用。

E. 顯示上述設施、休憩用地及該土地各部分的圖則

請參閱本部分中複製自附於批地文件附錄的圖則I及顯示行人道的圖。

F. 關於此等設施、休憩用地及該土地各部分之批地文件條款

1. 「批地文件」第(5)條批地特別條款訂明：

『(a) 「承批人」應：

- (i) 於本「協議」生效日後84個曆月內或「署長」批准的其他延長期限，自費以「署長」批准的方式及物料、標準、水平、走線和設計進行下列工程，以全面令「署長」滿意：
 - (I) 在本文所夾附「圖則I」以綠色顯示的日後興建公共道路範圍(以下統稱「綠色範圍」)進行鋪設及平整工程；及
 - (II) 提供和建造「署長」全權酌情為必要的橋、隧道、上跨路、下通道、下水道、高架道路、天橋、行人路、道路或其他構築物(以下統稱「構築物」)；

以便在「綠色範圍」建造建築物和供車輛及行人往來。
- (ii) 於本「協議」生效日後84個曆月內或「署長」批准的其他延長期限，自費以「署長」滿意的方式在「綠色範圍」鋪設表面、建造路緣及渠道，以及按「署長」要求為此等設施提供溝渠、污水管、排水渠、消防栓連接駁總水管的水管、街燈、交通標誌、街道設施及道路標記；及
- (iii) 自費維修「綠色範圍」及「構築物」和在該處建造、安裝及提供之所有構築物、表面、溝渠、污水管、排水渠、消防栓、服務設施、街燈、交通標誌、街道設施、道路標記及機器，以令「署長」滿意，直至「綠色範圍」的佔管權按照本文第(6)條批地特別條款交回「政府」為止。

- (b) 如「承批人」不在本批地特別條款(a)款指定的期限履行該款訂明的責任，「政府」可執行必要的工程，費用由「承批人」承擔。「承批人」須在接獲通知時向「政府」支付相等於工程費用的款項，金額由「署長」釐定，其決定將作終論並對「承批人」約束。

公共設施及公眾休憩用地的資料

(c) 倘因履行本批地特別條款(a)款所訂責任或因「政府」行使本批地特別條款(b)款等所訂的權利而導致「承批人」或任何人士蒙受或連帶招致任何損失、損害、滋擾或騷擾，「署長」概毋須就此承擔責任，「承批人」不得就此等損失、損害、滋擾或騷擾向「政府」、「署長」或其授權人員任何一方索償。』

2. 「批地文件」第(6)條批地特別條款訂明：

『茲為執行本文第(5)條批地特別條款指定的必要工程，「承批人」將在本「協議」生效日獲批授「綠色範圍」的佔管權。「綠色範圍」須在「政府」通知時交還，而於任何情況下其將被視作已於「署長」發函表示此等「批地條款」已圓滿履行當日由「承批人」交還「政府」。「承批人」佔管「綠色範圍」期間，必須於所有合理時間允許所有「政府」和公眾車輛及行人免費出入及通行「綠色範圍」，並且確保根據本文第(5)條批地特別條款等規定執行工程時不會干預或阻礙上述通行權。』

3. 「批地文件」第(7)條批地特別條款訂明：

『如非事前獲「署長」書面同意，「承批人」不可使用「綠色範圍」儲物或在該處搭建任何臨時構築物或作任何用途，惟執行本文第(5)條批地特別條款指明的工程除外。』

4. 「批地文件」第(8)條批地特別條款訂明：

『(a) 「承批人」佔管「綠色範圍」期間，必須於任何合理時間：

- (i) 允許「署長」、其官員、承辦商及其授權的任何其他人等進出及通行該地段和「綠色範圍」，以檢查、檢驗及監督任何遵照本文第(5)(a)條批地特別條款規定進行的工程，並且執行、檢查、檢驗和監督遵照本文第(5)(b)條批地特別條款訂明的工程和「綠色範圍」內「署長」視為必要的其他工程；
- (ii) 允許「政府」及其授權的相關公用事業公司有權按需要進出或再返回及行經該地段和「綠色範圍」，以在「綠色範圍」或任何毗連土地內、上或下執行工程，其中包括但不限於鋪設及其後維修所有水管、電線、管線、電纜管道及其他導體和附屬設備，以便提供擬供該地段或任何毗連或毗鄰土地或處所使用的電話、電力、氣體(如有者)及其他服務。「承批人」應與「政府」及「政府」正式授權的相關公用事業公司充分合作，以處理所有關乎任何上述「綠色範圍」工程的事項；及
- (iii) 允許水務監督人員及彼等授權的其他人等有權按需要進出或再返回及行經該地段及「綠色範圍」，以執行任何關於運作、維修、修理、更換及更改「綠色範圍」內任何其他水務裝置的工程。

(b) 倘因「政府」、其人員、代理、承辦商及任何其他人等或根據本批地特別條款(a)款正式獲授權的公用事業公司行使權利導致「承批人」或任何其他人士蒙受或連帶招致任何損失、損害、滋擾或騷擾，「政府」概毋須承擔責任。』

5. 「批地文件」第(9)條批地特別條款訂明：

- 『(a) 於本「協議」生效日後84個曆月內，「承批人」應自費以「署長」指定或批准的方式及物料、標準、樓層、走線和規格，以全面令「署長」滿意的方式在「批地文件」所夾附「圖則I」以粉紅色加黑點間紅斜線及粉紅色加黑點間黑斜線間紅斜線顯示的範圍或「署長」書面批准的其他地方提供和建造一條設有行人路的鋪築道路，連同相關的街道設施、交通輔助設施、街燈、污水管、排水渠及其他構築物(以下統稱「緊急車輛通道」)。
- (b) 「承批人」應在本文協定的整個批租年期內允許公眾、「政府」、其人員、代理、工人及「政府」授權的任何人士時刻自由及免付任何費用步行或駕車通行、行經及往返「緊急車輛通道」，以作所有合法用途。
- (c) 「承批人」應在本文協定的整個批租年期內，自費保養、維修和修理「緊急車輛通道」及附屬或從屬於該處的所有物件，以保持其清潔整齊、不受阻礙和維修充足及狀況良好，以令「署長」滿意。如「承批人」不如上保養、維修及修理「緊急車輛通道」，「政府」、「署長」或其授權的任何人士或人等可依法在「署長」視為恰當的時期內安排「緊急車輛通道」的清潔、整理或修理等工程，費用由「承批人」承擔。「承批人」須在「政府」通知時向「政府」支付相等於工程費用的款項，有關金額由「署長」釐定，而其決定將作終論並對「承批人」約束。
- (d) 如「承批人」不在本批地特別條款(a)款指定的期限履行該款訂明的責任，「政府」可執行必要的工程，費用由「承批人」承擔。「承批人」須在接獲通知時向「政府」支付相等於工程費用的款項，金額由「署長」釐定，其決定將作終論並對「承批人」約束。
- (e) 倘因「承批人」履行本批地特別條款(a)款所訂責任或因「政府」行使本批地特別條款(c)及(d)款等所訂的權利而導致「承批人」或任何人士蒙受或連帶招致任何損失、損害、滋擾或騷擾，「政府」、其人員、代理、承辦商、工人或其他獲授權人等概毋須就此承擔責任，「承批人」不得就此等損失、損害、滋擾或騷擾向「政府」、「署長」或其授權人員索償。
- (f) 現明確協議及聲明，儘管「承批人」須承擔本批地特別條款(b)款訂明的責任，「承批人」並無意向而「政府」並未同意將「緊急車輛通道」劃為公眾有權通行的範圍。
- (g) 現明確協議及聲明，儘管本批地特別條款(b)款訂明「承批人」須承擔責任，「承批人」概不可因此預期或索償任何特許權，或關於額外上蓋面積或地積比率的權利，不論是否根據《建築物(規劃)規例》第22(1)條、其任何修訂條文或取代條文等亦然。為免存疑，「承批人」現明確豁免任何及所有關乎《建築物(規劃)規例》第22(1)條、其任何修訂條文或取代條文所訂額外上蓋面積或地積比率之特許權的申索或相關權利。』

公共設施及公眾休憩用地的資料

6. 「批地文件」第(34)條批地特別條款訂明：

- 『(a) 「承批人」確認該地段由本文所夾附「圖則I」顯示及標記A點的西面邊界位置到東面邊界註明為FP的位置現有一條行人道橫越(以下簡稱「現有行人道」)。「承批人」應在「署長」指定的期限內及遵從「署長」訂明的條件和規定自費以「署長」批准或指定的樓層、走線、方式、物料、設計、標準及規格，在現有行人道進行更換工程，以建造和完成建造「署長」滿意的新行人道(以下簡稱「行人道」)，連接本文所夾附「圖則I」顯示並註明的A點及B點。為免存疑，「承批人」如非事前獲「署長」書面批准，不得拆卸、關閉現有行人道或其任何部份或安排改道。
- (b) 於本文協定的整個批租年期內，只要現有行人道尚未關閉，「承批人」時刻均應允許「政府」、其人員或授權人等及任何公眾免費通行、行經及往返現有行人道及「行人道」，以作任何合法用途。
- (c) 於本文協定的整個批租年期內，「承批人」須自費管理、維修和修理尚未關閉的現有行人道及「行人道」，以保持其維修充足及狀況良好，全面令「署長」滿意。
- (d) 倘因以下情況導致「政府」及「署長」招致任何性質的責任、訴訟、法律程序、費用、索償、開支、損失、損害、收費及索求，「承批人」現向「政府」及「署長」賠償並確保彼等免責：
- (i) 「承批人」、其代理、工人及承辦商就管理、維修或修理尚未關閉的現有行人道或「行人道」作出或漏作的行為；
- (ii) 現有行人道或其任何部份拆卸、關閉或改道；或
- (iii) 建造「行人道」。
- (e) 現明確協議及聲明，儘管「承批人」須承擔本批地特別條款(b)款訂明的責任，「承批人」並無意向而「政府」並未同意將尚未關閉的現有行人道或其任何部份、「行人道」或其任何部份或該地段任何部份劃為公眾有權通行的範圍。
- (f) 現明確協議及聲明，儘管本批地特別條款(b)款訂明「承批人」須承擔責任，「承批人」概不可因此預期或索償任何特許權，或關於額外上蓋面積或地積比率的權利，不論是否根據《建築物(規劃)規例》第22(1)條、其任何修訂條文或取代條文等亦然。為免存疑，「承批人」現明確豁免任何及所有關乎《建築物(規劃)規例》第22(1)條、其任何修訂條文或取代條文所訂額外上蓋面積或地積比率之特許權的申索或相關權利。

- (g) 如「承批人」不履行本批地特別條款(a)及(c)款所訂的責任，「政府」可執行必要的建造、維修或修理工程，費用由「承批人」承擔。「承批人」須在接獲通知時向「政府」支付相等於工程費用的款項，金額由「署長」釐定，其決定將作終論並對「承批人」約束。為執行上述工程，「政府」、其人員、代理、承辦商、工人或其他正式獲授權人等均擁有自由及不受阻礙的權利，可於任何合理時間進入該地段或其任何部份和現已或將會建於該處任何一座或多座建築物。倘因「政府」、其人員、代理、承辦商、工人或其他正式獲授權人等行使本款所訂權利而令「承批人」蒙受或連帶招致任何損失、損害、滋擾或騷擾，「政府」、其人員、代理、承辦商、工人或其他正式獲授權人等概毋須就此承擔責任，「承批人」不得就此等損失、損害、滋擾或騷擾向彼等或當中任何一方索償。』

G. 關於各設施、休憩用地及該土地各部分之個別住宅物業的公契條款

1. 「公契」第1.1條訂明：

『於「本契約」內，除上下文意另有訂明或規定外，以下詞語將具以下釋義：

「發展項目公用地方與設施」指：

- (a) 「公共緊急車輛通道」、「行人道」、「綠色範圍」(只要是構成「發展項目公用地方與設施」一部分)、「渠務專用範圍」、「看更及管理員辦事處」及「業主委員會辦事處」；
- (b) 管理員宿舍、走廊、行車道、緊急發電機房、緊急車輛通道、風機房、消防控制室、風機房、樓梯平台、街道消防栓泵房、泵房、雨水儲存缸、斜路、垃圾及物料回收房、污水處理裝置機房、樓梯、電掣房、電訊及廣播設備室、變壓器房、電纜裝置及所有相關設施、非挖掘範圍、主水錶房、水錶櫃、街道消防栓水箱、消防花灑系統控制閥櫃、水箱；及
- (c) 「該土地」及「發展項目」內擬供「發展項目」整體公用與共享的地方及設施

現於本文所夾附的圖則以綠色、綠色間黑斜線及綠色間黑交叉線顯示，以資識別。

此外，於適當情況下，如(i)「發展項目」任何部分符合《建築物管理條例》第2條中「公用部分」第(a)段的釋義及/或(ii)「發展項目」任何部分乃《建築物管理條例》附表1訂明而符合《建築物管理條例》第2條中「公用部份」第(b)段的釋義，此等地方將受制於前述的規定，並且視作屬於「發展項目公用地方與設施」一部分，

但不包括「屋苑公用地方與設施」、「住宅公用地方與設施」、「住宅大廈公用地方與設施」、「住宅大樓公用地方與設施」、「商業公用地方與設施」及「停車場公用地方與設施」；

公共設施及公眾休憩用地的資料

「行人道」

指依照「政府批地書」第(34)條批地特別條款規定，在本文所夾附圖則以綠色顯示並註明為FOOTPATH的「該土地」地下低層及地下部分提供的行人道；

「政府批地書」

指於土地註冊處註冊為《新批地文件》第21303號的《換地協議及條件》，並且包括不時訂立的修訂本、修改本、更新本或補充本；

「綠色範圍」

指「政府批地書」第(5)(a)(i)(I)條批地特別條款所載的「綠色範圍」，即「政府批地書」所夾附註明為PLAN I圖則以綠色顯示的範圍；

「綠色範圍構築物」

指地政總署署長全權酌情指定的橋、隧道、上跨道、下通道、下水道、高架道路、行車天橋、行人路、道路或其他構築物，即「政府批地書」第(5)(a)(i)(II)條批地特別條款所載並界定的「構築物」；

「公共緊急車輛通道」

指依照「政府批地書」第(9)(a)條批地特別條款規定，在「政府批地書」所夾附註明為PLAN I圖則以粉紅色加黑點間紅斜線及粉紅色加黑點間黑斜線間紅斜線顯示的「該土地」部分提供和建造的鋪築道路連行人道及相關街道設施、交通輔助設施、街燈、污水管、排水渠及其他構築物，現於本文所夾附的圖則以綠色加黑交叉線顯示並註明為PUBLIC EVA，以資識別。』

2. 「公契」第4.6條訂明：

『年度預算案應涵蓋「公用地方與設施」、「綠色範圍」、「綠色範圍構築物」、「綠色間黑斜線範圍」及「棕色範圍」之「管理開支」，而茲毋損前文之一般規定，包括但不限於：

...

- (o) 根據「本契約」規定及/或遵從「政府批地書」修理、維修及管理「綠色範圍」、「綠色範圍構築物」、「綠色間黑斜線範圍」、「棕色範圍」、「公共緊急車輛通道」及「行人道」的費用。』

3. 「公契」第4.7條訂明：

『年度預算案應分為以下各部份：

- (a) 第一部份涵蓋「經理人」認為(其決定如無重大錯誤將作終論)乃本着全體「業主」利益而花費，而且乃完善管理「該土地」及「發展項目」、「發展項目公用地方與設施」、「綠色範圍」、「綠色範圍構築物」、「綠色間黑斜線範圍」及「棕色範圍」所需或必要的所有開支。

...』

4. 「公契」第5.2條訂明：

『茲毋損本文所載「經理人」明確擁有其他權力之一般規定，「經理人」有權：

...

- (j) 遵照「本契約」及「政府批地書」維修、管理和修理「綠色範圍」、「綠色範圍構築物」、「綠色間黑斜線範圍」、「棕色範圍」、「公共緊急車輛通道」及「行人道」。』

5. 「公契」第10.12條訂明：

『儘管本文另有任何規定，以及直至「綠色範圍」的佔管權已按照「政府批地書」交還或視作交還「政府」為止，「經理人」應遵照「政府批地書」第(5)(a)(iii)條批地特別條款規定，負責維修「綠色範圍」及「綠色範圍構築物」連同於該處建造、安裝及提供之所有構築物、表面、溝渠、污水管、排水渠、消防栓、服務裝置、街燈、交通標誌、街道設施、道路標記及機器，而「業主」須承擔維修及修理「綠色範圍」、「綠色範圍構築物」及該處其他構築物的費用與開支，猶如其乃「公用地方與設施」一部分。』

6. 「公契」第10.13條訂明：

『「業主」應遵照「政府批地書」第(9)(c)條批地特別條款規定保養、維修和修理「公共緊急車輛通道」及其所有附屬及從屬物，維持其清潔整齊、不受阻礙和維修充足及狀態良好，以令地政總署署長滿意。』

7. 「公契」第10.15條訂明：

『「業主」應遵照「政府批地書」第(34)(c)條批地特別條款規定管理、維修和修理「行人道」，以保持其維修充足及狀況良好，全面令地政總署署長滿意。』

公共設施及公眾休憩用地的資料

8. 「公契」第二附錄B部份第1段訂明：

『「業主」所持每份「不分割份數」和持有、使用、佔用及享用其樓宇的專有權，必須遵從以下權利及特權：

...

(c) 公眾、「政府」、其人員、代理、工人及「政府」授權的任何人士時刻均享有通行權，可自由及完全免費地步行或駕車通行、進出、往返及行經「公共緊急車輛通道」，以作所有合法用途；

(d) 「政府」、其人員或獲授權人等及所有公眾人士享有通行權，毋須繳付任何費用，可步行通過、進出、往返及行經「行人道」，以作所有合法用途；

...』

9. 「公契」第三附錄第51條訂明：

『除「公共緊急車輛通道」外，「渠務專用範圍」上、下或內概不可建造任何建築物或構築物或任何建築物或構築物的地基或支承件。如事前獲地政總署署長書面批准，可將「渠務專用範圍」改道或搬遷至「該土地」其他地方。』

公共設施及公眾休憩用地的資料

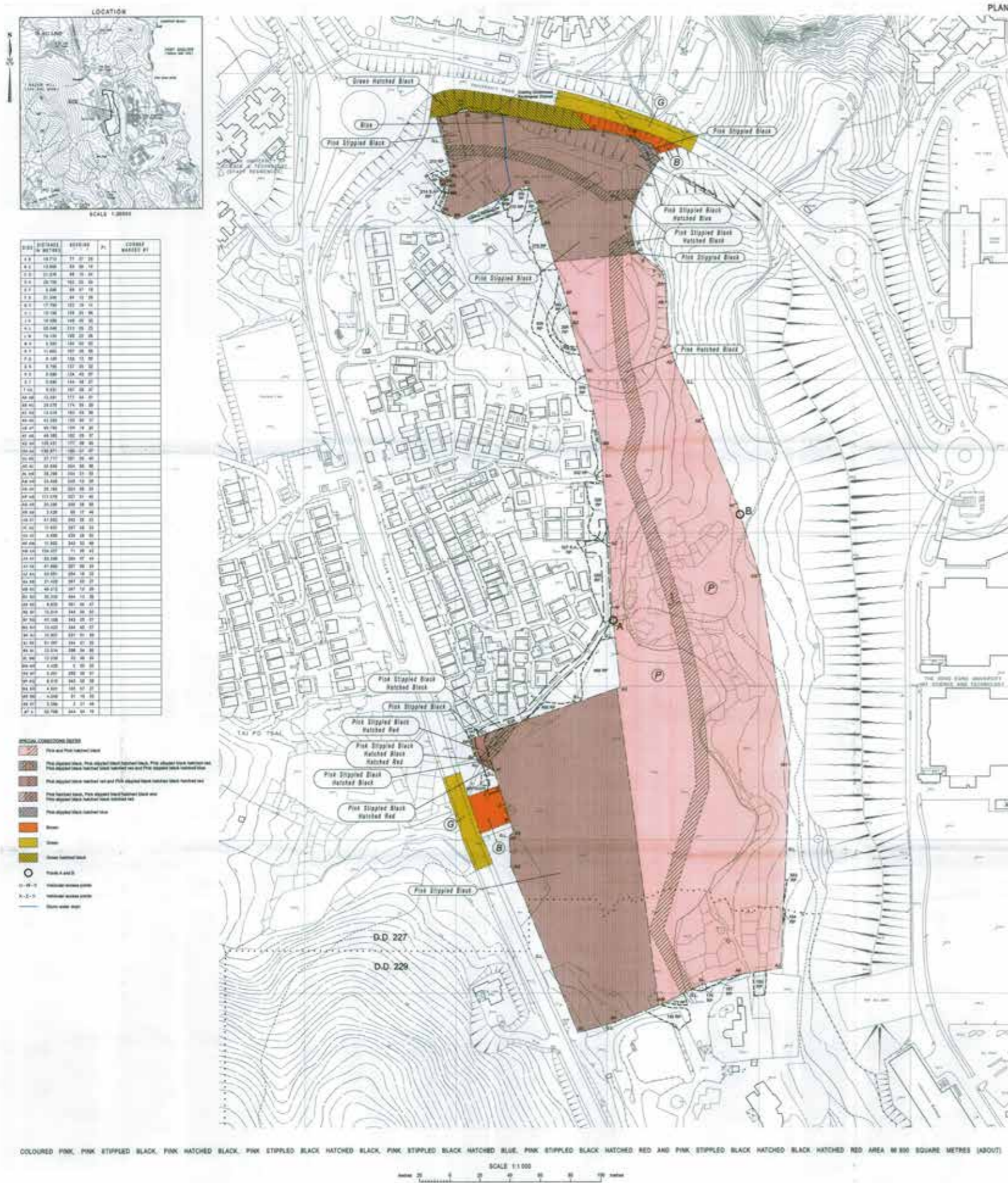

Legend 圖例

-  Pink and Pink hatched black
粉紅色及粉紅色加黑斜線
-  Pink stippled black, Pink stippled black hatched black, Pink stippled black hatched red, Pink stippled black hatched black hatched red and Pink stippled black hatched blue
粉紅色加黑點，粉紅色加黑點加黑斜線，粉紅色加黑點加紅斜線，粉紅色加黑點加黑斜線加紅斜線及粉紅色加黑點加藍斜線
-  Pink stippled black hatched red and Pink stippled black hatched black hatched red
粉紅色加黑點加紅斜線及粉紅色加黑點加黑斜線加紅斜線
-  Pink hatched black, Pink stippled black hatched black and Pink stippled black hatched black hatched red
粉紅色加黑斜線，粉紅色加黑點加黑斜線及粉紅色加黑點加黑斜線加紅斜線
-  Pink stippled black hatched blue
粉紅色加黑點加藍斜線
-  Brown
棕色
-  Green
綠色
-  Green hatched black
綠色加黑斜線
-  Points A and B
A點及B點

Remark :

This plan is a reproduction of Plan I annexed to the Land Grant showing the location of those facilities and open spaces, and those parts of the land as referred to in this section.

備註 :

本圖乃複製自附於批地文件的圖則 I 顯示本章節提及的有關設施、休憩用地及該土地各部分之位置。

Footpath Plan 行人道圖

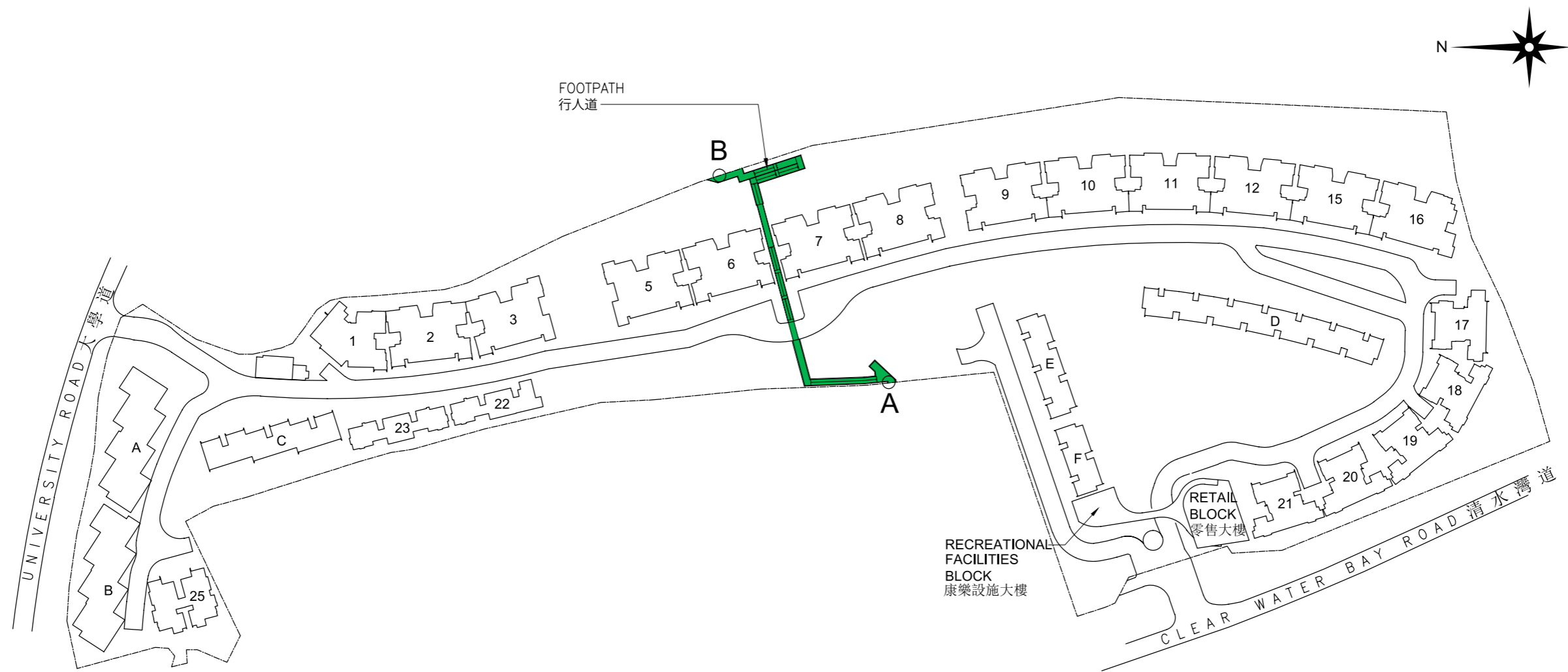

Remark:

This plan is prepared for showing the location of the Footpath only, based on the latest approved building plans of the development.

備註：

此圖是以最新經批准的建築圖則作依據僅為顯示行人道的位置而擬備。

Warning to purchasers

對買方的警告

- (a) The purchaser is recommended to instruct a separate firm of solicitors (other than that acting for the owner) to act for the purchaser in relation to the transaction.
 - (b) If the purchaser instructs such separate firm of solicitors to act for the purchaser in relation to the transaction, that firm will be able to give independent advice to the purchaser.
 - (c) If the purchaser instructs the firm of solicitors acting for the owner to act for the purchaser as well, and a conflict of interest arises between the owner and the purchaser -
 - (i) that firm may not be able to protect the purchaser's interests; and
 - (ii) the purchaser may have to instruct a separate firm of solicitors.
 - (d) In the case of paragraph (c)(ii), the total solicitors' fees payable by the purchaser may be higher than the fees that would have been payable if the purchaser had instructed a separate firm of solicitors in the first place.
- (a) 現建議買方聘用一間獨立的律師事務所（代表擁有人行事者除外），以在交易中代表買方行事。
 - (b) 如買方聘用上述的獨立的律師事務所，以在交易中代表買方行事，該律師事務所將會能夠向買方提供獨立意見。
 - (c) 如買方聘用代表擁有人行事的律師事務所同時代表買方行事，而擁有人與買方之間出現利益衝突 -
 - (i) 該律師事務所可能不能夠保障買方的利益；及
 - (ii) 買方可能要聘用一間獨立的律師事務所。
 - (d) 如屬(c)(ii)段的情況，買方須支付的律師費用總數，可能高於如買方自一開始即聘用一間獨立的律師事務所便須支付的費用。

Cross-section plan of building in the development

發展項目中的建築物的橫截面圖

Cross-Section Plan A1 橫截面圖 A1

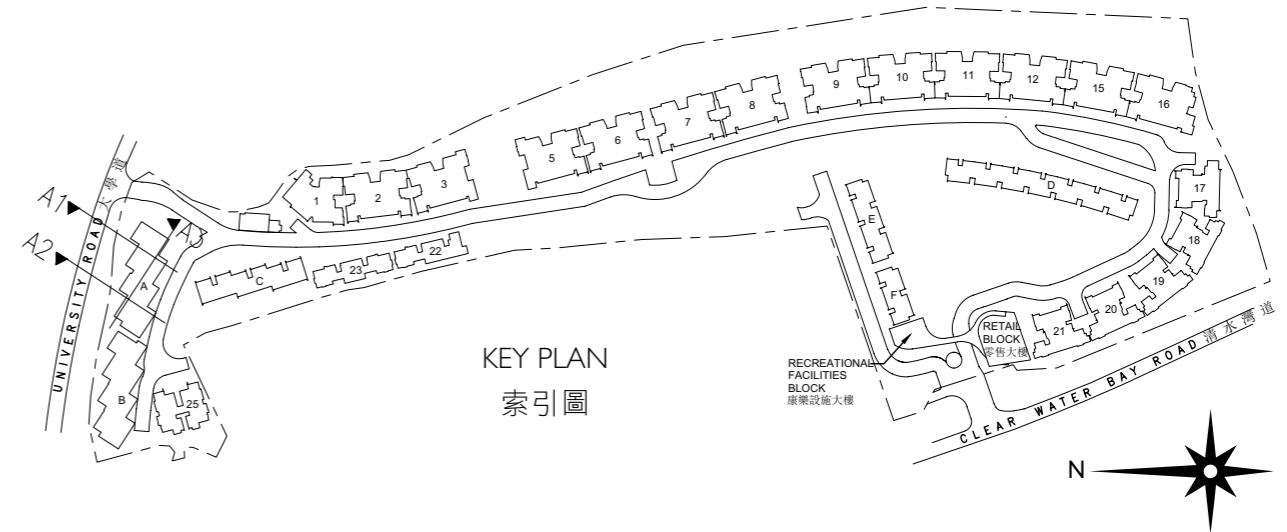
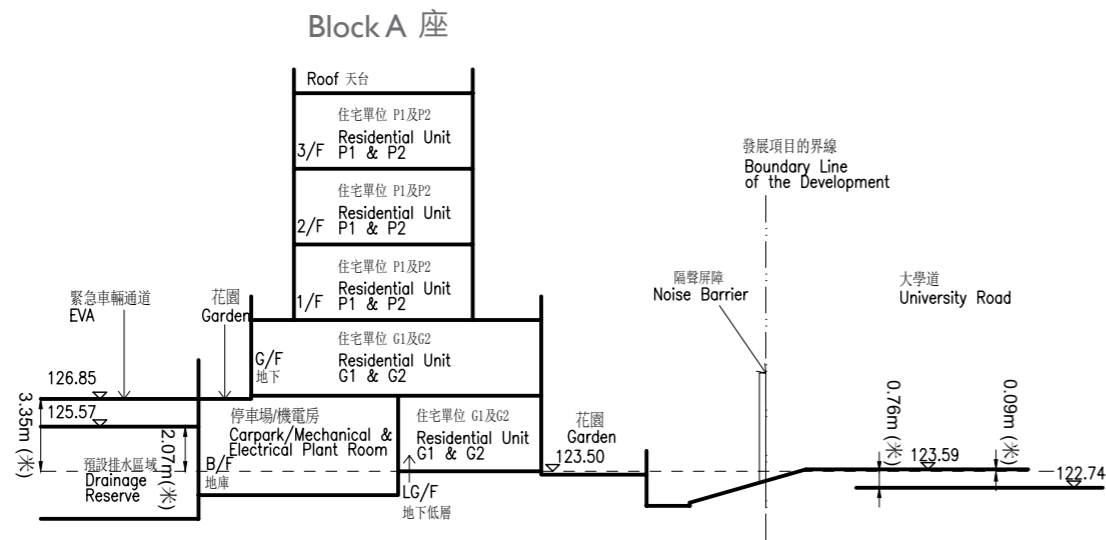

-- Dotted line denotes the lowest residential floor: 虛線為最低住宅樓層水平
EVA : Emergency Vehicular Access 緊急車輛通道

The part of Emergency Vehicular Access adjacent to the building is 125.57 to 126.85 metres above the Hong Kong Principal Datum.

毗連建築物的一段緊急車輛通道為香港主水平基準以上125.57米至126.85米。

The part of University Road adjacent to the building is 122.74 to 123.59 metres above the Hong Kong Principal Datum.

毗連建築物的一段大學道為香港主水平基準以上122.74米至123.59米。

Cross-Section Plan A2 橫截面圖 A2

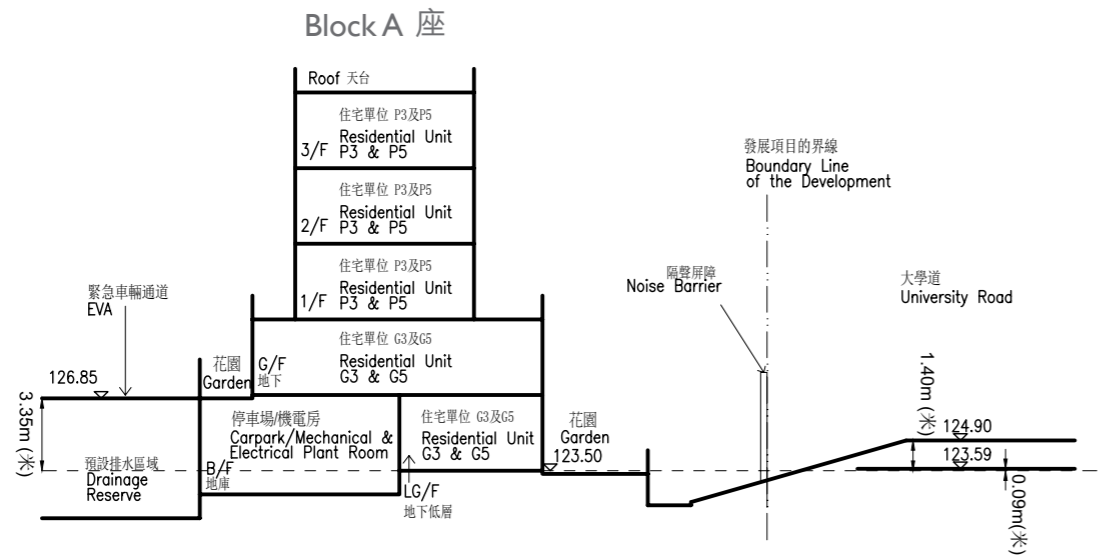

The part of Emergency Vehicular Access adjacent to the building is 126.85 metres above the Hong Kong Principal Datum.

毗連建築物的一段緊急車輛通道為香港主水平基準以上126.85米。

The part of University Road adjacent to the building is 123.59 to 124.90 metres above the Hong Kong Principal Datum.

毗連建築物的一段大學道為香港主水平基準以上123.59米至124.90米。

Remarks:

- In the description of residential property in a residential block, the prefix "G" means Garden Duplex unit and the numbering means the numbering of Garden Duplex unit of Block A, B, C, D, E or F (as the case may be). e.g. "G1" refers to Garden Duplex 1 of Block A, B, C, D, E or F (as the case may be).
- In the description of residential property in a residential block, the prefix "P" means Penthouse Triplex unit and the numbering means the numbering of Penthouse Triplex unit of Block A, B, D, E or F (as the case may be). e.g. "P1" refers to Penthouse Triplex 1 of Block A, B, D, E or F (as the case may be).

Cross-Section Plan A3 橫截面圖 A3

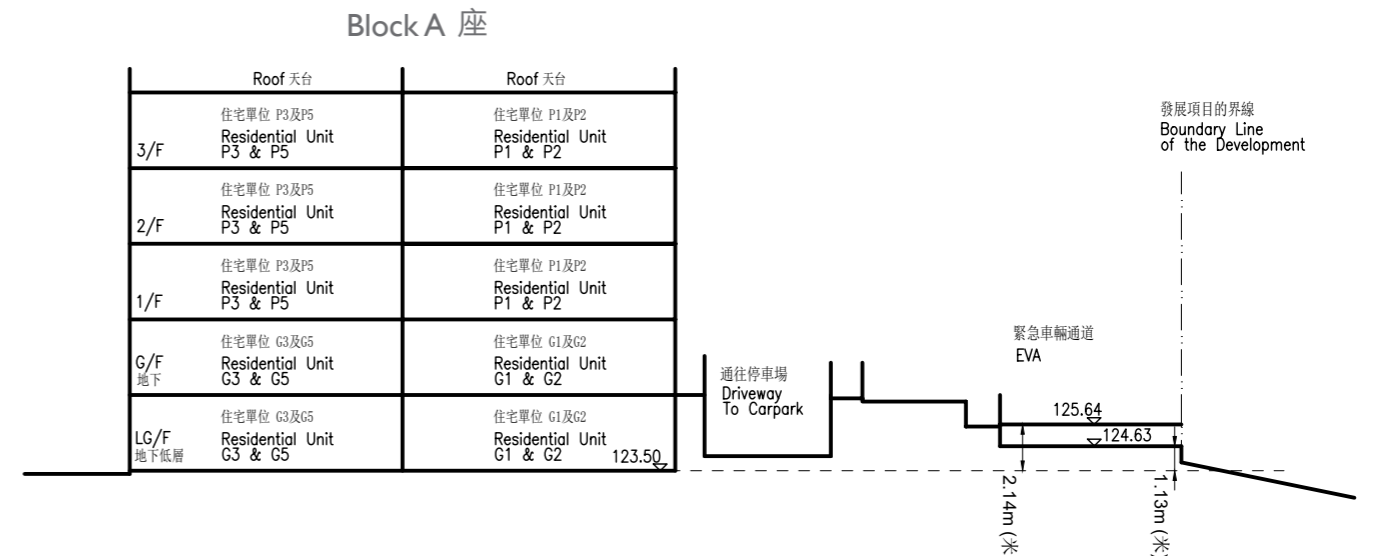

The part of Emergency Vehicular Access adjacent to the building is 124.63 to 125.64 metres above the Hong Kong Principal Datum.

毗連建築物的一段緊急車輛通道為香港主水平基準以上124.63至125.64米。

備註:

- 住宅大樓的住宅物業的描述中，字首「G」指花園複式單位，而編號指A、B、C、D、E或F座(視情況而定)的花園複式單位的編號。例如「G1」指A、B、C、D、E或F座(視情況而定)的花園複式1號單位。
- 住宅大樓中住宅物業的描述中，字首「P」指頂層三複式單位，而編號指A、B、D、E或F座(視情況而定)的頂層三複式單位的編號。例如「P1」指A、B、D、E或F座(視情況而定)的頂層三複式1號單位。

Cross-section plan of building in the development

發展項目中的建築物的橫截面圖

Cross-Section Plan B1 橫截面圖 B1

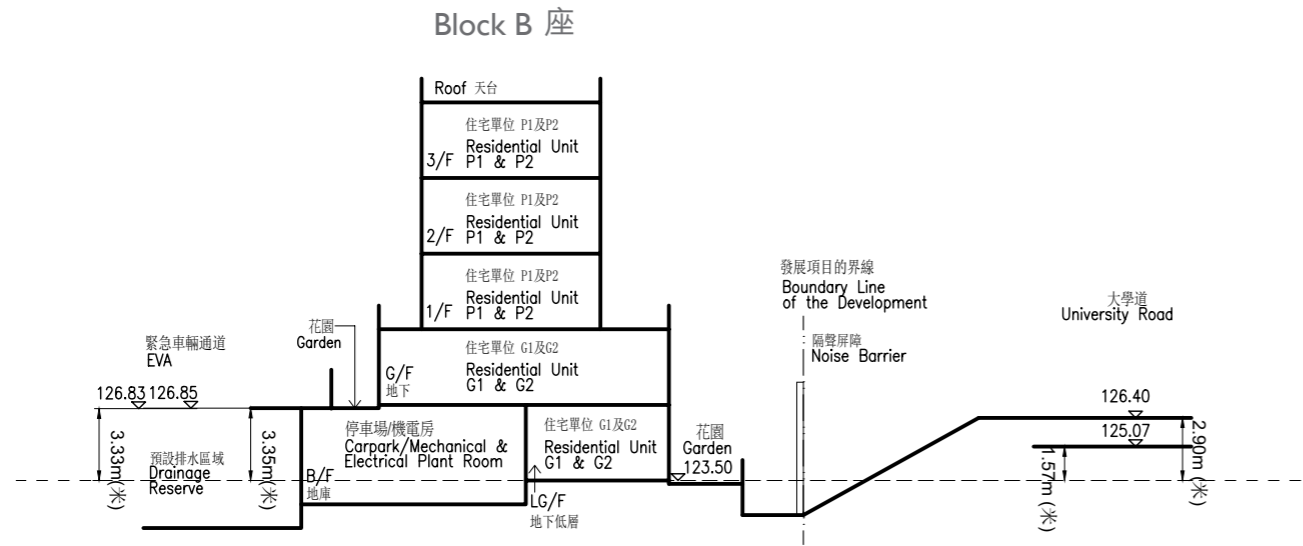

The part of Emergency Vehicular Access adjacent to the building is 126.83 to 126.85 metres above the Hong Kong Principal Datum.
The part of University Road adjacent to the building is 125.07 to 126.40 metres above the Hong Kong Principal Datum.

毗連建築物的一段緊急車輛通道為香港主水平基準以上126.83至126.85米。
毗連建築物的一段大學道為香港主水平基準以上125.07米至126.40米。

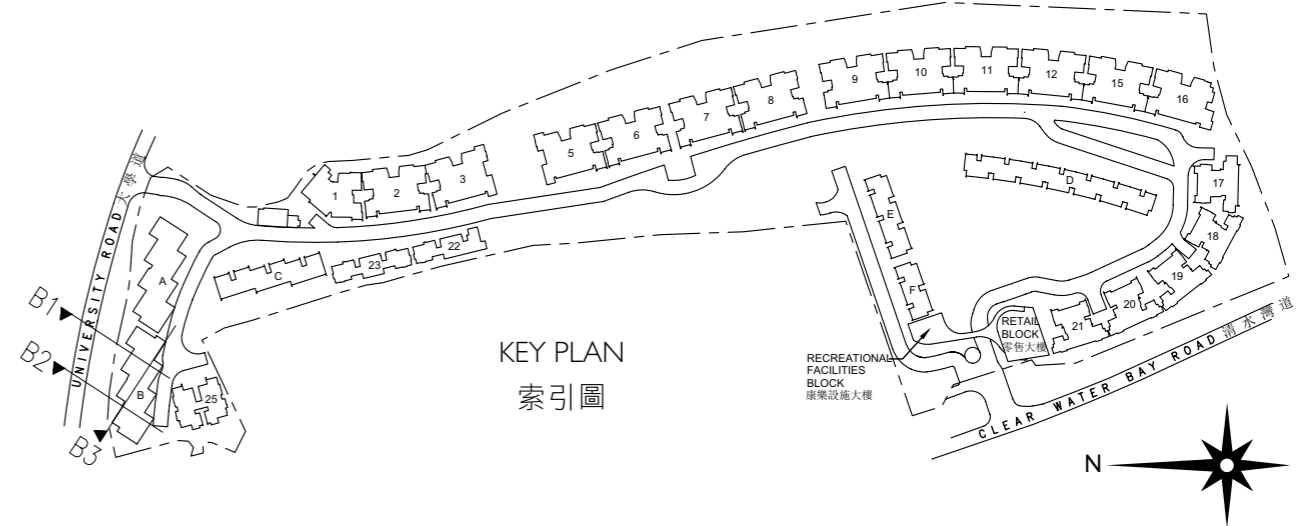

-- Dotted line denotes the lowest residential floor. 虛線為最低住宅樓層水平
EVA : Emergency Vehicular Access 緊急車輛通道

Cross-Section Plan B2 橫截面圖 B2

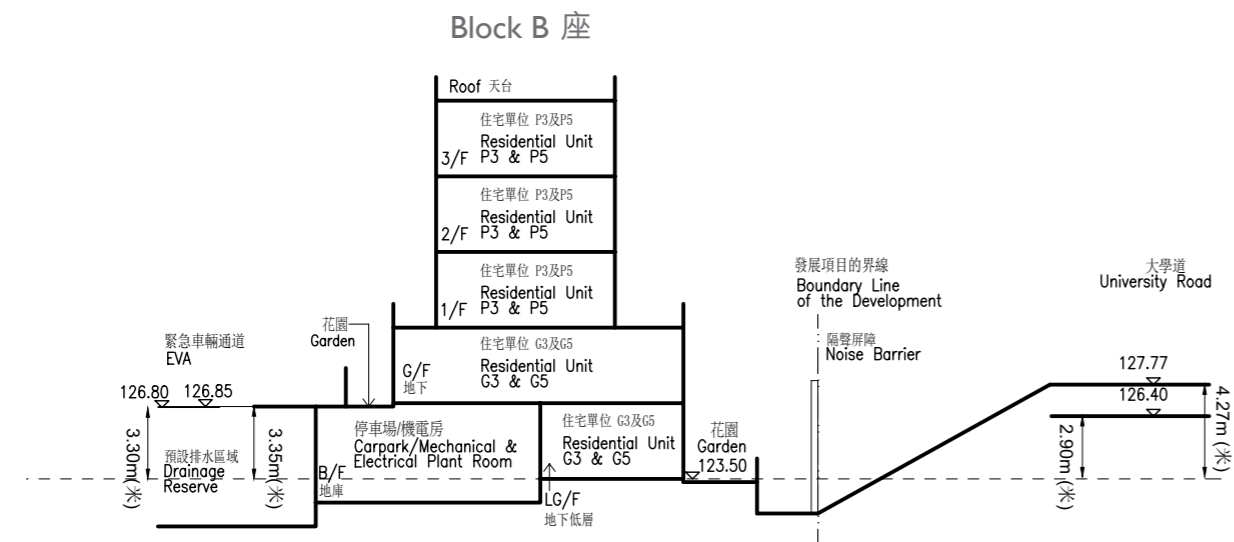

The part of Emergency Vehicular Access adjacent to the building is 126.80 to 126.85 metres above the Hong Kong Principal Datum.
The part of University Road adjacent to the building is 126.40 to 127.77 metres above the Hong Kong Principal Datum.

毗連建築物的一段緊急車輛通道為香港主水平基準以上126.80至126.85米。
毗連建築物的一段大學道為香港主水平基準以上126.40米至127.77米。

Cross-Section Plan B3 橫截面圖 B3

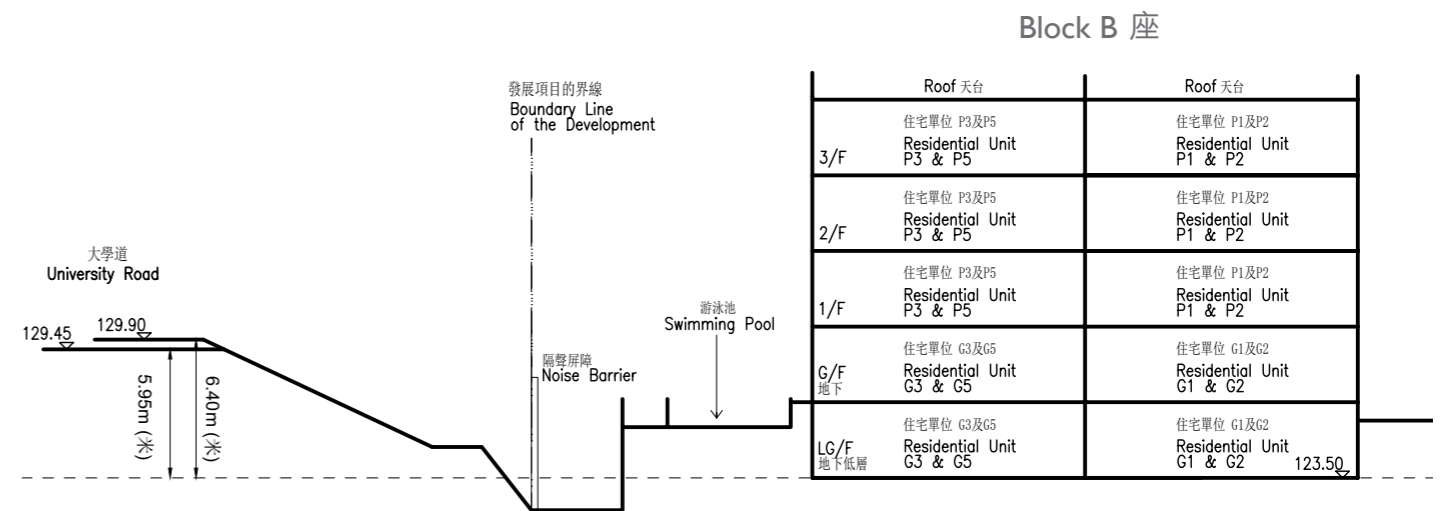

The part of University Road adjacent to the building is 129.45 to 129.90 metres above the Hong Kong Principal Datum.

毗連建築物的一段大學道為香港主水平基準以上129.45米至129.90米。

Remarks:

- In the description of residential property in a residential block, the prefix "G" means Garden Duplex unit and the numbering means the numbering of Garden Duplex unit of Block A, B, C, D, E or F (as the case may be). e.g. "G1" refers to Garden Duplex 1 of Block A, B, C, D, E or F (as the case may be).
- In the description of residential property in a residential block, the prefix "P" means Penthouse Triplex unit and the numbering means the numbering of Penthouse Triplex unit of Block A, B, D, E or F (as the case may be). e.g. "P1" refers to Penthouse Triplex 1 of Block A, B, D, E or F (as the case may be).

備註:

- 住宅大樓的住宅物業的描述中，字首「G」指花園複式單位，而編號指A、B、C、D、E或F座(視情況而定)的花園複式單位的編號。例如「G1」指A、B、C、D、E或F座(視情況而定)的花園複式1號單位。
- 住宅大樓中住宅物業的描述中，字首「P」指頂層三複式單位，而編號指A、B、D、E或F座(視情況而定)的頂層三複式單位的編號。例如「P1」指A、B、D、E或F座(視情況而定)的頂層三複式1號單位。

Cross-section plan of building in the development

發展項目中的建築物的橫截面圖

Cross-Section Plan C1 橫截面圖 C1

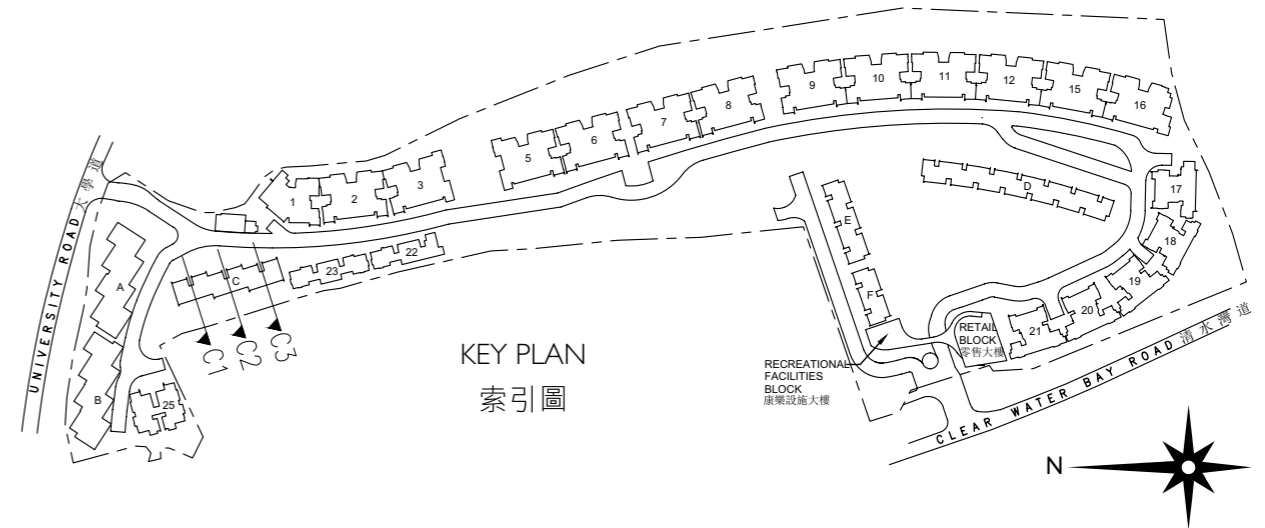
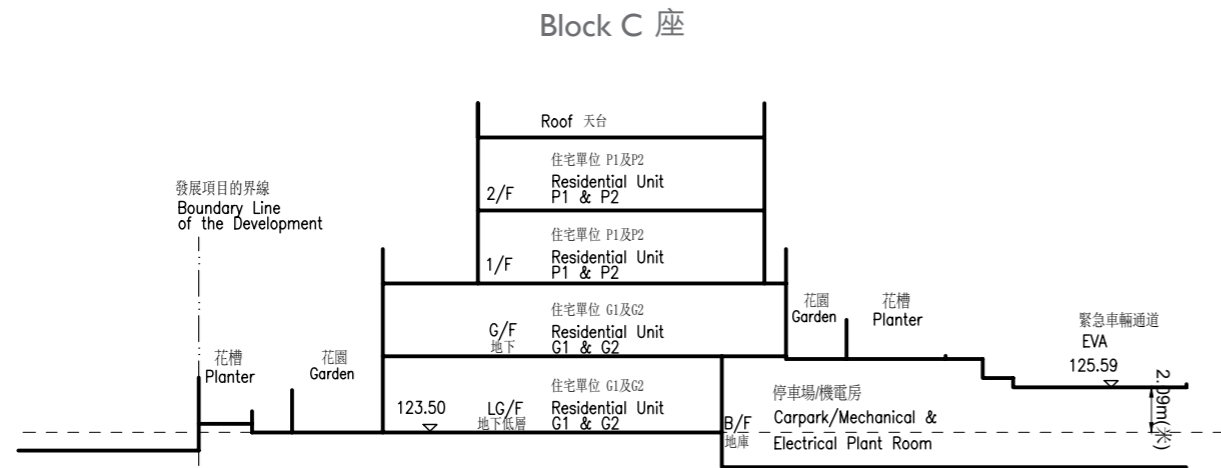

-- Dotted line denotes the lowest residential floor: 虛線為最低住宅樓層水平
EVA : Emergency Vehicular Access 緊急車輛通道

The part of Emergency Vehicular Access adjacent to the building is 125.59 metres above the Hong Kong Principal Datum. 毗連建築物的一段緊急車輛通道為香港主水平基準以上125.59米。

Cross-Section Plan C2 橫截面圖 C2

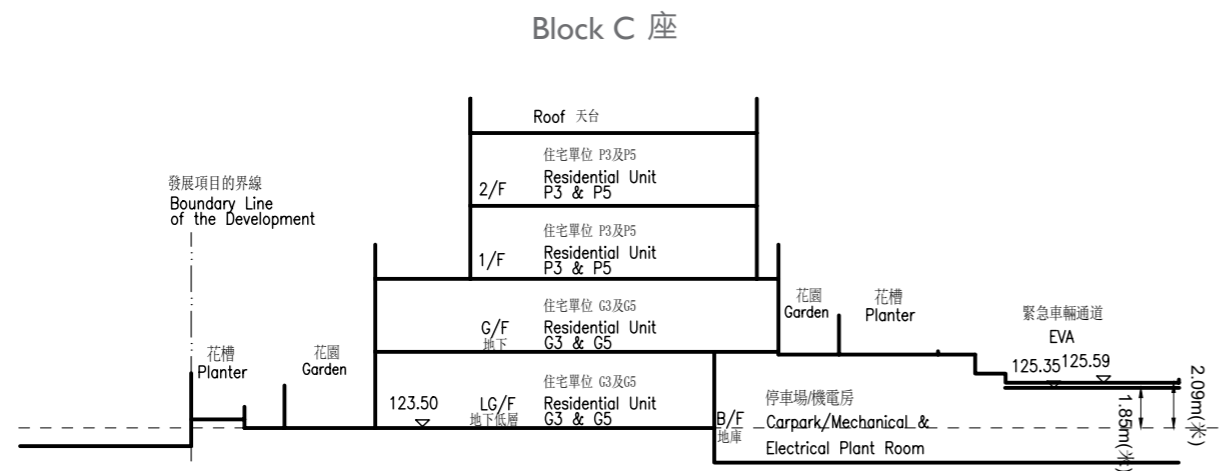

The part of Emergency Vehicular Access adjacent to the building is 125.35 to 125.59 metres above the Hong Kong Principal Datum. 毗連建築物的一段緊急車輛通道為香港主水平基準以上125.35至125.59米。

Cross-Section Plan C3 橫截面圖 C3

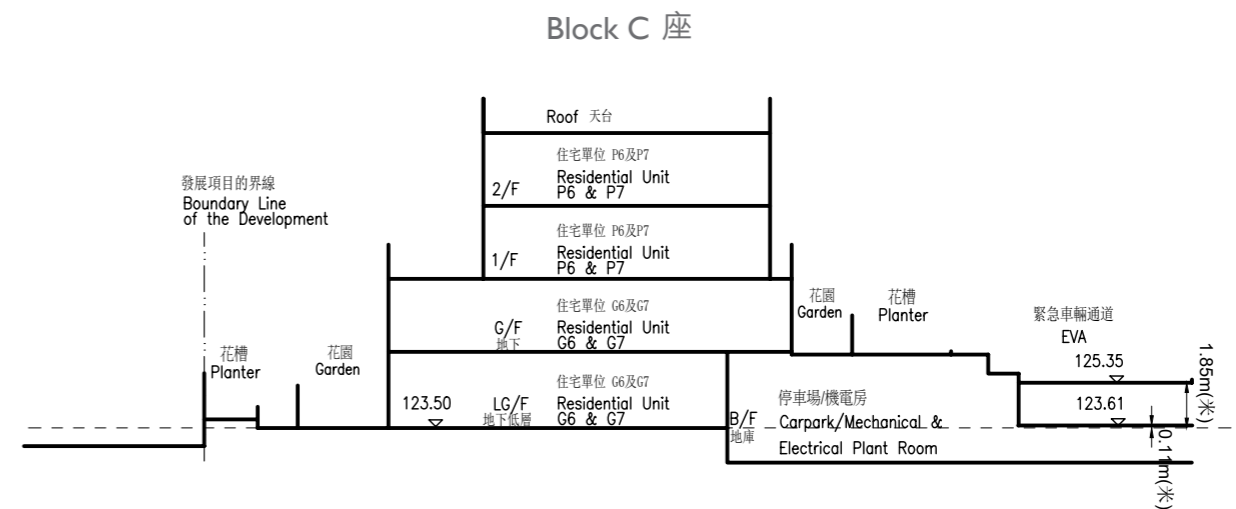

The part of Emergency Vehicular Access adjacent to the building is 123.61 to 125.35 metres above the Hong Kong Principal Datum. 毗連建築物的一段緊急車輛通道為香港主水平基準以上123.61至125.35米。

Remarks:

- In the description of residential property in a residential block, the prefix "G" means Garden Duplex unit and the numbering means the numbering of Garden Duplex unit of Block A, B, C, D, E or F (as the case may be). e.g. "G1" refers to Garden Duplex 1 of Block A, B, C, D, E or F (as the case may be).
- In the description of residential property in a residential block, the prefix "P" means Penthouse Duplex unit and the numbering means the numbering of Penthouse Duplex unit of Block C. e.g. "P1" refers to Penthouse Duplex 1 of Block C.

備註:

- 住宅大樓的住宅物業的描述中，字首「G」指花園複式單位，而編號指A、B、C、D、E或F座(視情況而定)的花園複式單位的編號。例如「G1」指A、B、C、D、E或F座(視情況而定)的花園複式1號單位。
- 住宅大樓中住宅物業的描述中，字首「P」指頂層複式單位，而編號指C座的頂層複式單位的編號。例如「P1」指C座的頂層複式1號單位。

Cross-section plan of building in the development

發展項目中的建築物的橫截面圖

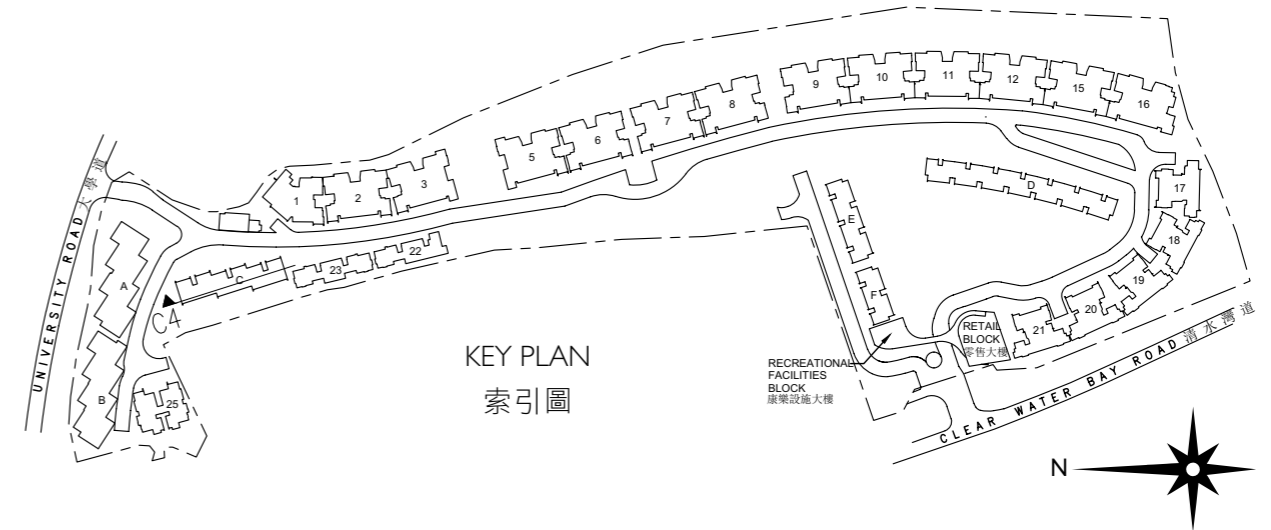

-- Dotted line denotes the lowest residential floor. 虛線為最低住宅樓層水平
 EVA : Emergency Vehicular Access 緊急車輛通道

Cross-Section Plan C4 橫截面圖 C4

Block C 座

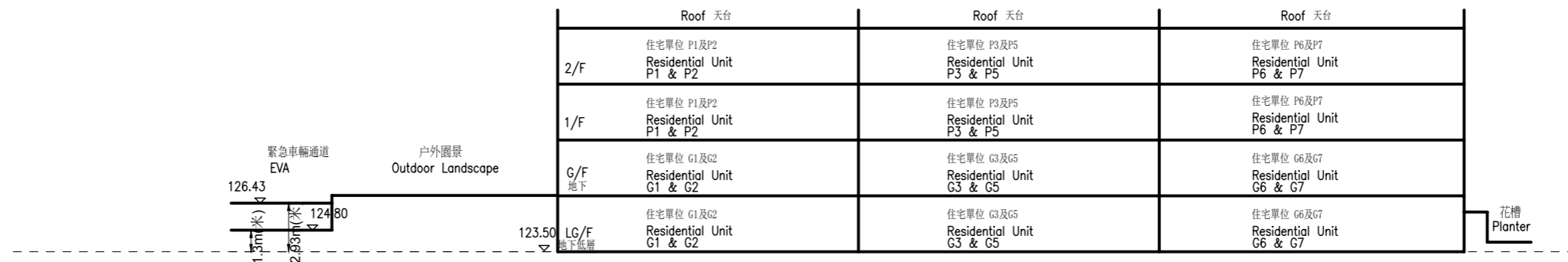

The part of Emergency Vehicular Access adjacent to the building is 124.80 to 126.43 metres above the Hong Kong Principal Datum. 毗連建築物的一段緊急車輛通道為香港主水平基準以上124.80至126.43米。

Remarks:

- In the description of residential property in a residential block, the prefix "G" means Garden Duplex unit and the numbering means the numbering of Garden Duplex unit of Block A, B, C, D, E or F (as the case may be). e.g. "G1" refers to Garden Duplex 1 of Block A, B, C, D, E or F (as the case may be).
- In the description of residential property in a residential block, the prefix "P" means Penthouse Duplex unit and the numbering means the numbering of Penthouse Duplex unit of Block C. e.g. "P1" refers to Penthouse Duplex 1 of Block C.

備註:

- 住宅大樓的住宅物業的描述中，字首「G」指花園複式單位，而編號指A、B、C、D、E或F座(視情況而定)的花園複式單位的編號。例如「G1」指A、B、C、D、E或F座(視情況而定)的花園複式1號單位。
- 住宅大樓中住宅物業的描述中，字首「P」指頂層複式單位，而編號指C座的頂層複式單位的編號。例如「P1」指C座的頂層複式1號單位。

Cross-section plan of building in the development

發展項目中的建築物的橫截面圖

Cross-Section Plan D1 橫截面圖 D1

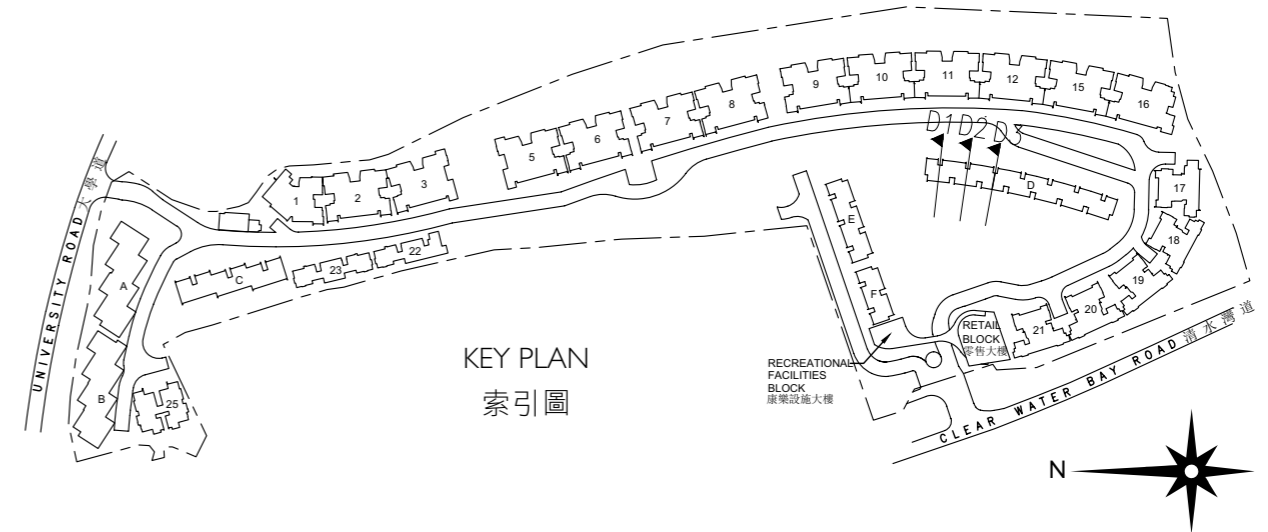
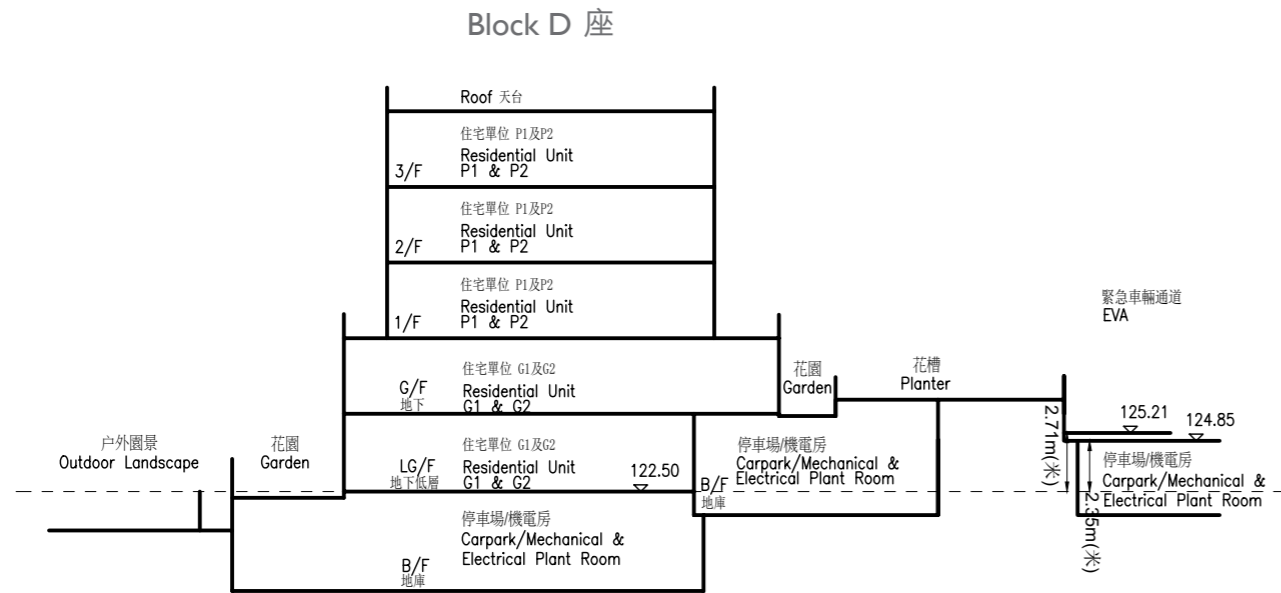

-- Dotted line denotes the lowest residential floor: 虛線為最低住宅樓層水平
EVA : Emergency Vehicular Access 緊急車輛通道

The part of Emergency Vehicular Access adjacent to the building is 124.85 to 125.21 metres above the Hong Kong Principal Datum. 毗連建築物的一段緊急車輛通道為香港主水平基準以上124.85至125.21米。

Cross-Section Plan D2 橫截面圖 D2

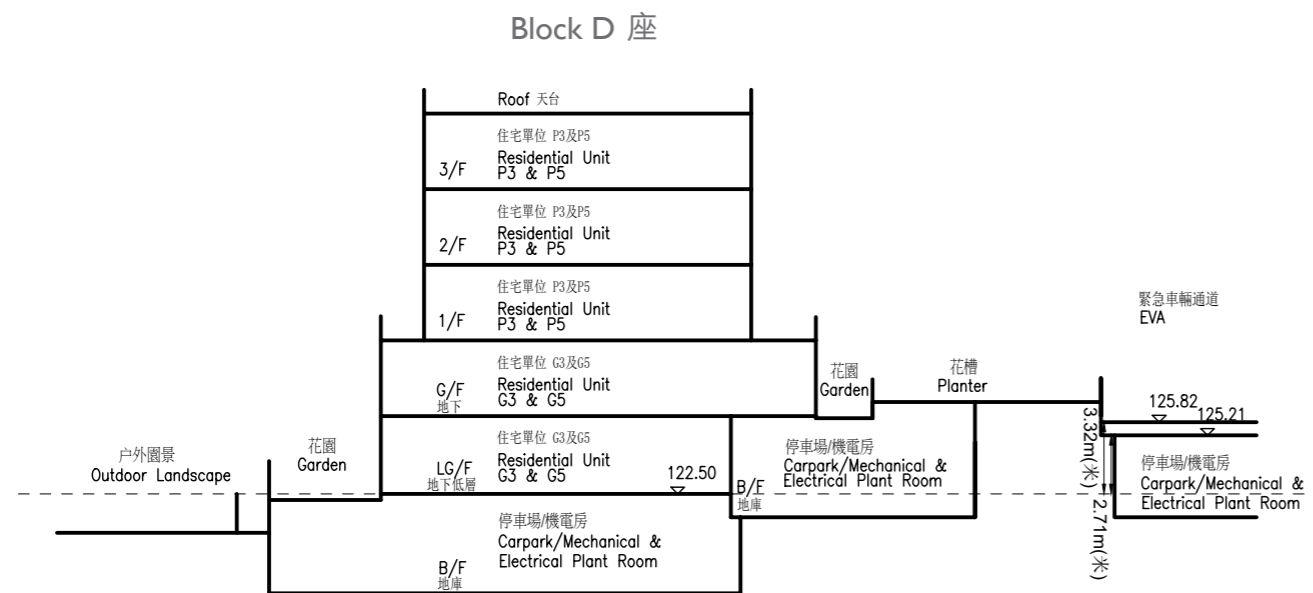

The part of Emergency Vehicular Access adjacent to the building is 125.21 to 125.82 metres above the Hong Kong Principal Datum. 毗連建築物的一段緊急車輛通道為香港主水平基準以上125.21至125.82米。

Cross-Section Plan D3 橫截面圖 D3

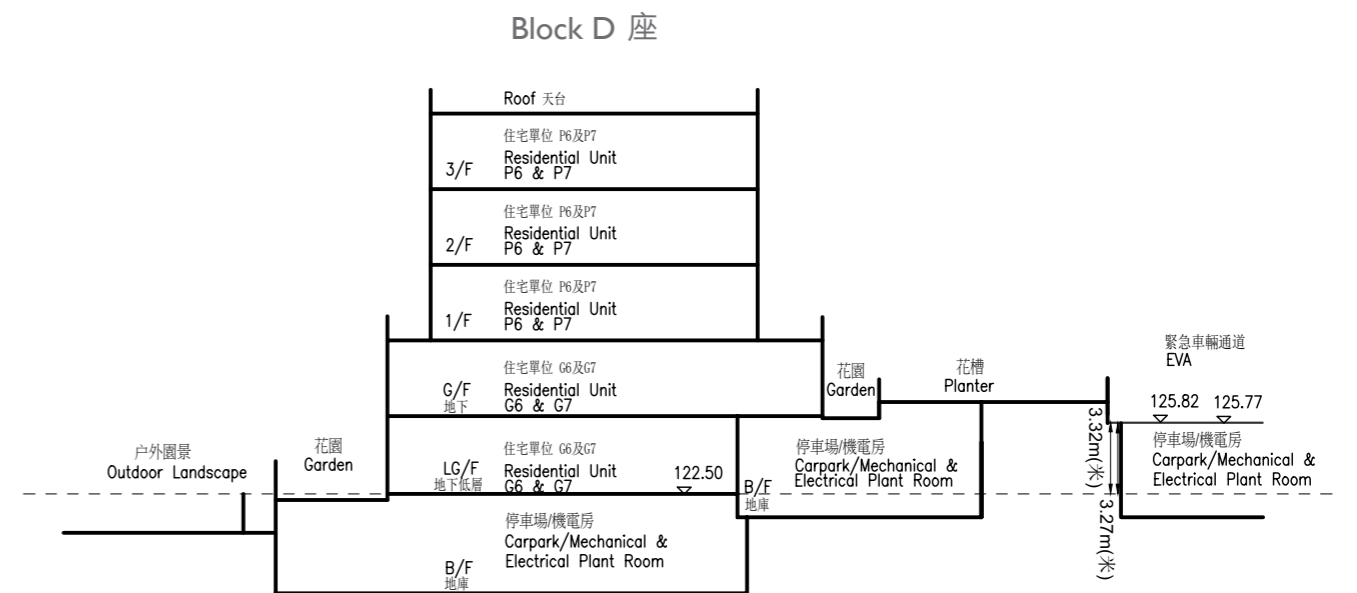

The part of Emergency Vehicular Access adjacent to the building is 125.77 to 125.82 metres above the Hong Kong Principal Datum. 毗連建築物的一段緊急車輛通道為香港主水平基準以上125.77至125.82米。

Remarks:

- In the description of residential property in a residential block, the prefix "G" means Garden Duplex unit and the numbering means the numbering of Garden Duplex unit of Block A, B, C, D, E or F (as the case may be). e.g. "G1" refers to Garden Duplex 1 of Block A, B, C, D, E or F (as the case may be).
- In the description of residential property in a residential block, the prefix "P" means Penthouse Triplex unit and the numbering means the numbering of Penthouse Triplex unit of Block A, B, D, E or F (as the case may be). e.g. "P1" refers to Penthouse Triplex 1 of Block A, B, D, E or F (as the case may be).

備註:

- 住宅大樓的住宅物業的描述中，字首「G」指花園複式單位，而編號指A、B、C、D、E或F座(視情況而定)的花園複式單位的編號。例如「G1」指A、B、C、D、E或F座(視情況而定)的花園複式1號單位。
- 住宅大樓中住宅物業的描述中，字首「P」指頂層三複式單位，而編號指A、B、D、E或F座(視情況而定)的頂層三複式單位的編號。例如「P1」指A、B、D、E或F座(視情況而定)的頂層三複式1號單位。

Cross-section plan of building in the development

發展項目中的建築物的橫截面圖

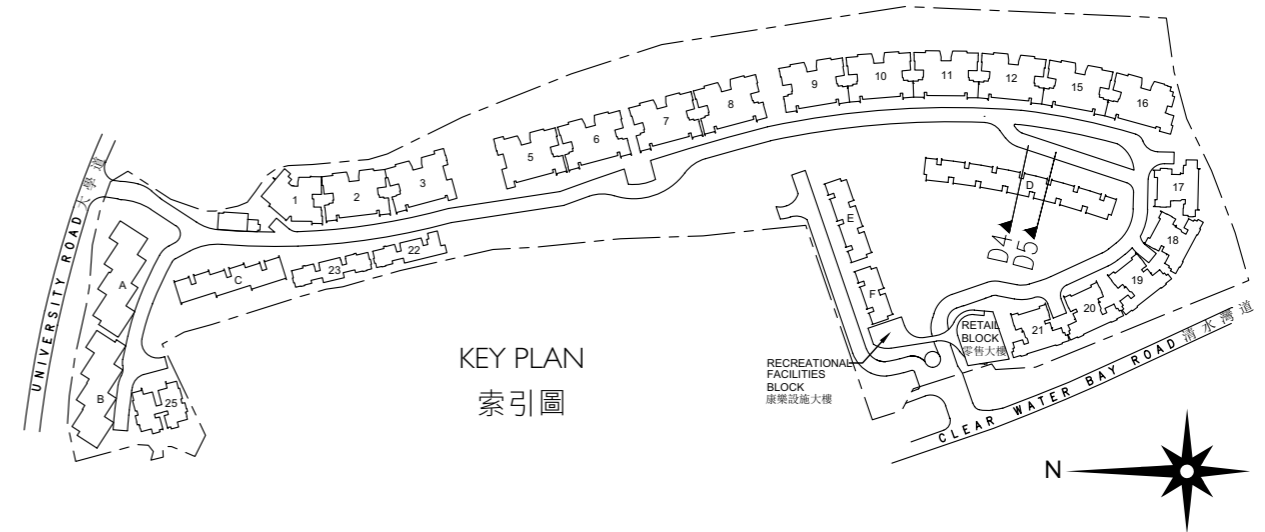

-- Dotted line denotes the lowest residential floor. 虛線為最低住宅樓層水平
EVA : Emergency Vehicular Access 緊急車輛通道

Cross-Section Plan D4 橫截面圖 D4

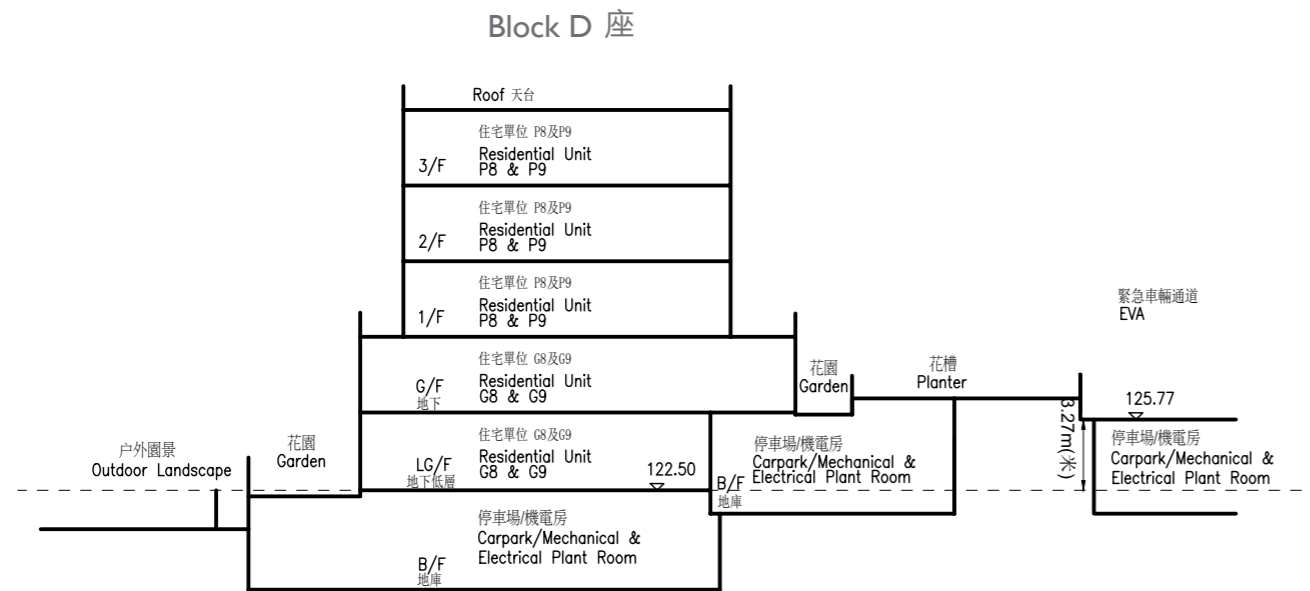

The part of Emergency Vehicular Access adjacent to the building is 毗連建築物的一段緊急車輛通道為香港
125.77 metres above the Hong Kong Principal Datum. 主水平基準以上125.77米。

Remarks:

- In the description of residential property in a residential block, the prefix "G" means Garden Duplex unit and the numbering means the numbering of Garden Duplex unit of Block A, B, C, D, E or F (as the case may be). e.g. "G1" refers to Garden Duplex 1 of Block A, B, C, D, E or F (as the case may be).
- In the description of residential property in a residential block, the prefix "P" means Penthouse Triplex unit and the numbering means the numbering of Penthouse Triplex unit of Block A, B, D, E or F (as the case may be). e.g. "P1" refers to Penthouse Triplex 1 of Block A, B, D, E or F (as the case may be).

Cross-Section Plan D5 橫截面圖 D5

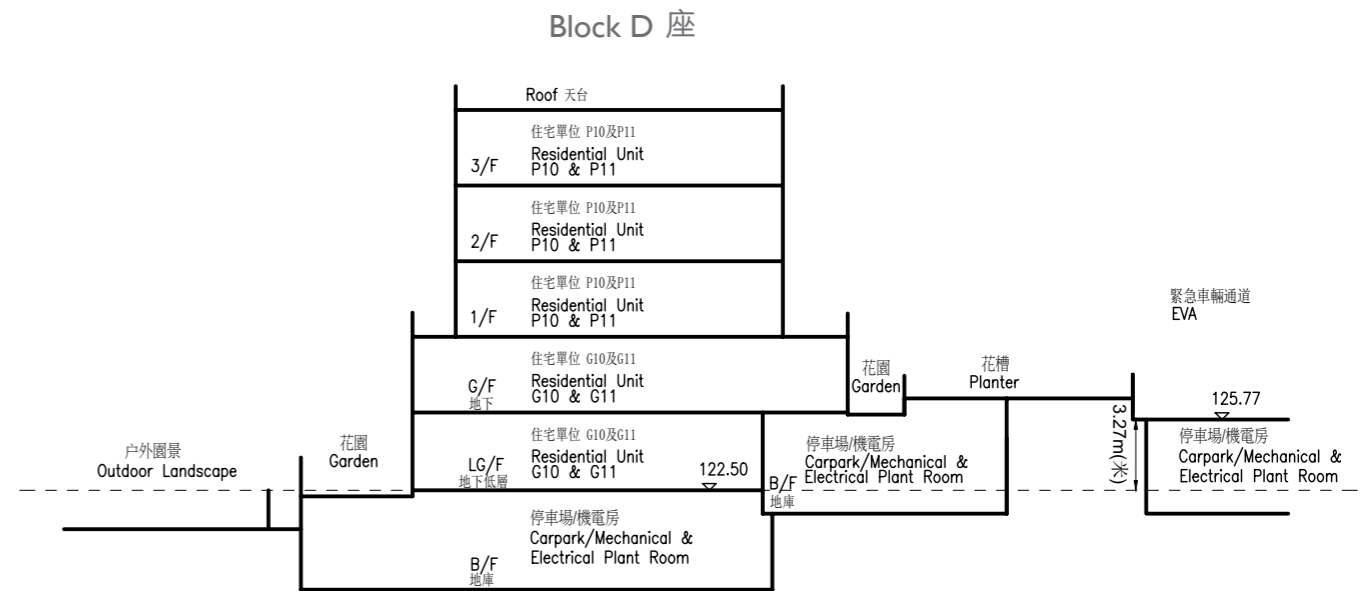

The part of Emergency Vehicular Access adjacent to the building is 毗連建築物的一段緊急車輛通道為香港
125.77 metres above the Hong Kong Principal Datum. 主水平基準以上125.77米。

備註:

- 住宅大樓的住宅物業的描述中，字首「G」指花園複式單位，而編號指A、B、C、D、E或F座(視情況而定)的花園複式單位的編號。例如「G1」指A、B、C、D、E或F座(視情況而定)的花園複式1號單位。
- 住宅大樓中住宅物業的描述中，字首「P」指頂層三複式單位，而編號指A、B、D、E或F座(視情況而定)的頂層三複式單位的編號。例如「P1」指A、B、D、E或F座(視情況而定)的頂層三複式1號單位。

Cross-section plan of building in the development

發展項目中的建築物的橫截面圖

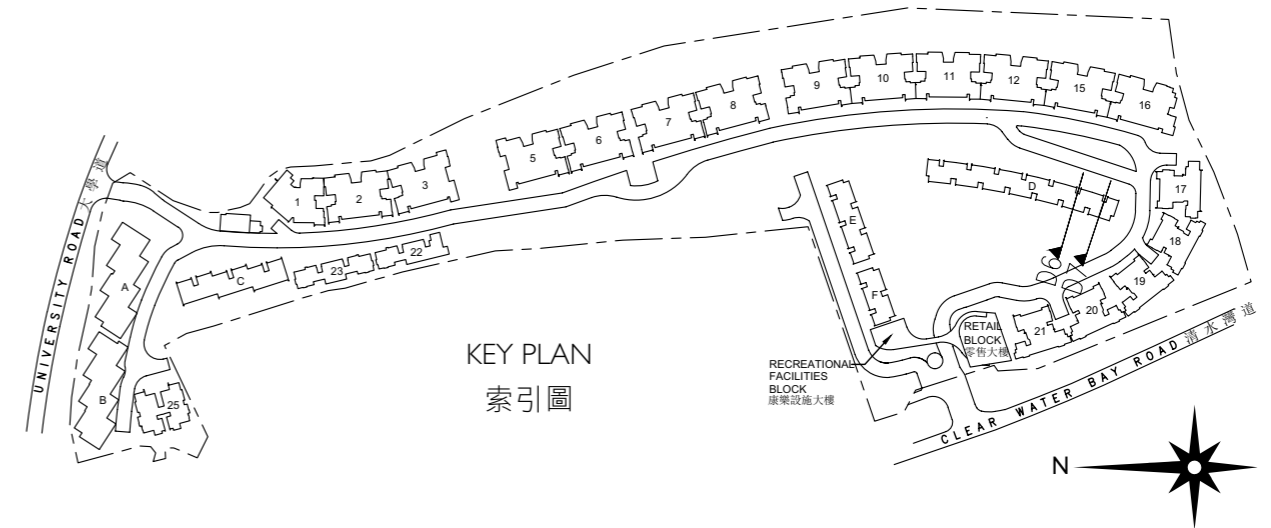

-- Dotted line denotes the lowest residential floor: 虛線為最低住宅樓層水平
 EVA : Emergency Vehicular Access 緊急車輛通道

Cross-Section Plan D6 橫截面圖 D6

Block D 座

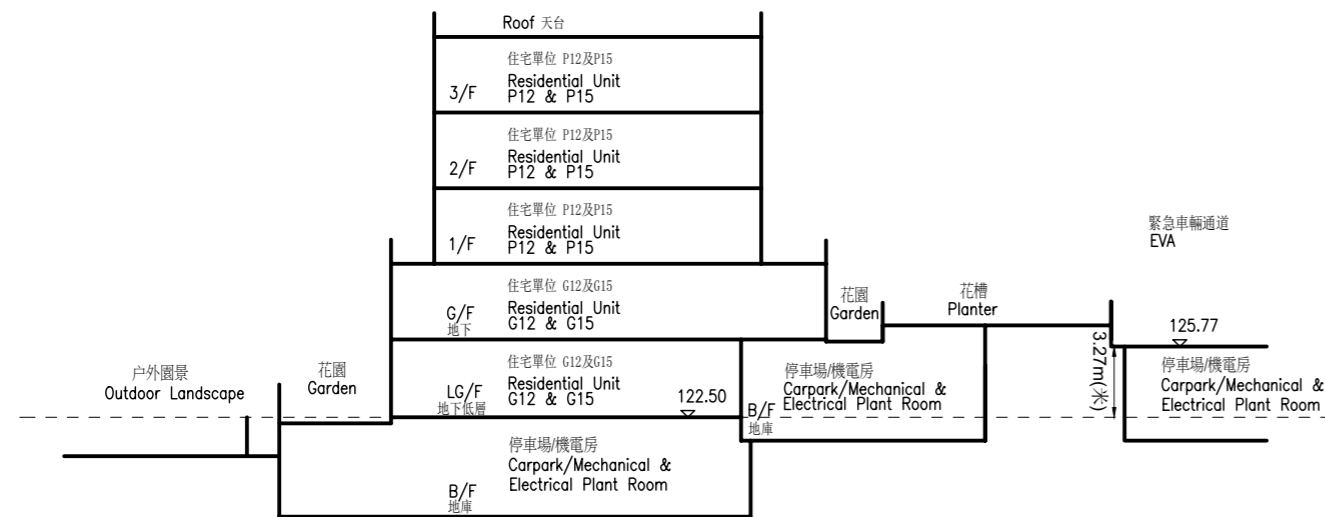

The part of Emergency Vehicular Access adjacent to the building is 125.77 metres above the Hong Kong Principal Datum. 毗連建築物的一段緊急車輛通道為香港主水平基準以上125.77米。

Remarks:

- In the description of residential property in a residential block, the prefix "G" means Garden Duplex unit and the numbering means the numbering of Garden Duplex unit of Block A, B, C, D, E or F (as the case may be). e.g. "G1" refers to Garden Duplex 1 of Block A, B, C, D, E or F (as the case may be).
- In the description of residential property in a residential block, the prefix "P" means Penthouse Triplex unit and the numbering means the numbering of Penthouse Triplex unit of Block A, B, D, E or F (as the case may be). e.g. "P1" refers to Penthouse Triplex 1 of Block A, B, D, E or F (as the case may be).

Cross-Section Plan D7 橫截面圖 D7

Block D 座

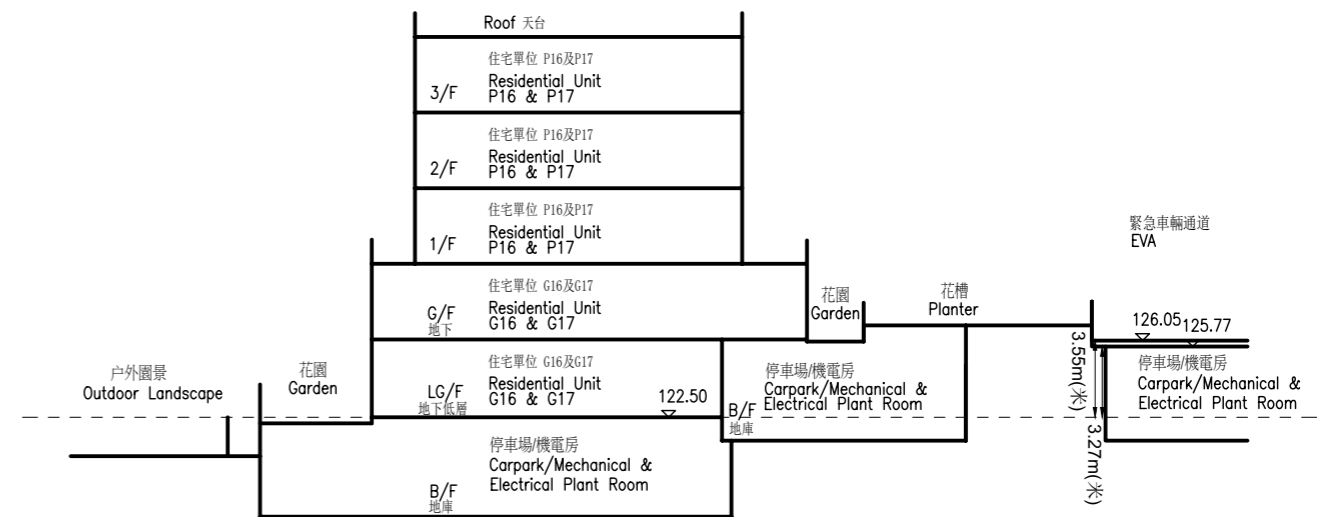

The part of Emergency Vehicular Access adjacent to the building is 125.77 to 126.05 metres above the Hong Kong Principal Datum. 毗連建築物的一段緊急車輛通道為香港主水平基準以上125.77至126.05米。

備註:

- 住宅大樓的住宅物業的描述中，字首「G」指花園複式單位，而編號指A、B、C、D、E或F座(視情況而定)的花園複式單位的編號。例如「G1」指A、B、C、D、E或F座(視情況而定)的花園複式1號單位。
- 住宅大樓中住宅物業的描述中，字首「P」指頂層三複式單位，而編號指A、B、D、E或F座(視情況而定)的頂層三複式單位的編號。例如「P1」指A、B、D、E或F座(視情況而定)的頂層三複式1號單位。

Cross-section plan of building in the development

發展項目中的建築物的橫截面圖

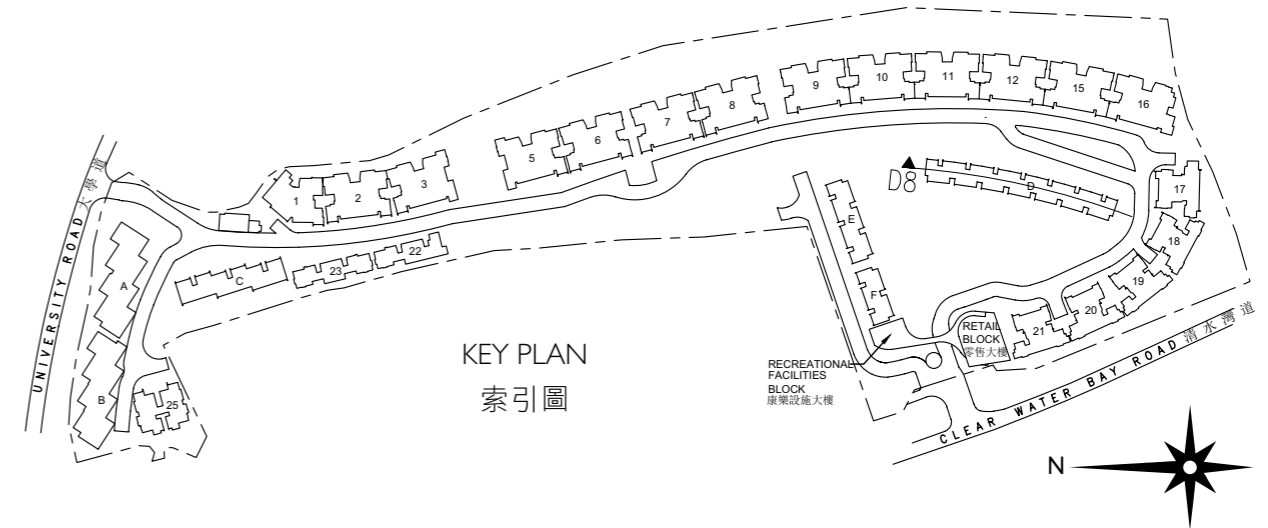

-- Dotted line denotes the lowest residential floor. 虛線為最低住宅樓層水平
EVA : Emergency Vehicular Access 緊急車輛通道

Cross-Section Plan D8 橫截面圖 D8

Block D 座

	Roof 天台	Roof 天台	Roof 天台	Roof 天台	Roof 天台	Roof 天台	Roof 天台
3/F	住宅單位 P1及P2 Residential Unit P1 & P2	住宅單位 P3及P5 Residential Unit P3 & P5	住宅單位 P6及P7 Residential Unit P6 & P7	住宅單位 P8及P9 Residential Unit P8 & P9	住宅單位 P10及P11 Residential Unit P10 & P11	住宅單位 P12及P15 Residential Unit P12 & P15	住宅單位 P16及P17 Residential Unit P16 & P17
2/F	住宅單位 P1及P2 Residential Unit P1 & P2	住宅單位 P3及P5 Residential Unit P3 & P5	住宅單位 P6及P7 Residential Unit P6 & P7	住宅單位 P8及P9 Residential Unit P8 & P9	住宅單位 P10及P11 Residential Unit P10 & P11	住宅單位 P12及P15 Residential Unit P12 & P15	住宅單位 P16及P17 Residential Unit P16 & P17
1/F	住宅單位 P1及P2 Residential Unit P1 & P2	住宅單位 P3及P5 Residential Unit P3 & P5	住宅單位 P6及P7 Residential Unit P6 & P7	住宅單位 P8及P9 Residential Unit P8 & P9	住宅單位 P10及P11 Residential Unit P10 & P11	住宅單位 P12及P15 Residential Unit P12 & P15	住宅單位 P16及P17 Residential Unit P16 & P17
G/F 地下	住宅單位 G1及G2 Residential Unit G1 & G2	住宅單位 G3及G5 Residential Unit G3 & G5	住宅單位 G6及G7 Residential Unit G6 & G7	住宅單位 G8及G9 Residential Unit G8 & G9	住宅單位 G10及G11 Residential Unit G10 & G11	住宅單位 G12及G15 Residential Unit G12 & G15	住宅單位 G16及G17 Residential Unit G16 & G17
戶外園景 Outdoor Landscape	住宅單位 G1及G2 Residential Unit G1 & G2	住宅單位 G3及G5 Residential Unit G3 & G5	住宅單位 G6及G7 Residential Unit G6 & G7	住宅單位 G8及G9 Residential Unit G8 & G9	住宅單位 G10及G11 Residential Unit G10 & G11	住宅單位 G12及G15 Residential Unit G12 & G15	住宅單位 G16及G17 Residential Unit G16 & G17
LG/F 地下底層	122.50						
B/F 地庫				停車場/機電房 Carpark/Mechanical & Electrical Plant Room			康樂設施 Recreational Facilities

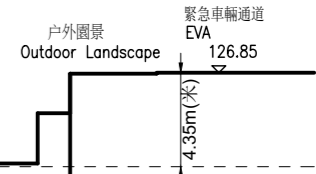

The part of Emergency Vehicular Access adjacent to the building is 126.85 metres above the Hong Kong Principal Datum. 毗連建築物的一段緊急車輛通道為香港主水平基準以上126.85米。

Remarks:

- In the description of residential property in a residential block, the prefix "G" means Garden Duplex unit and the numbering means the numbering of Garden Duplex unit of Block A, B, C, D, E or F (as the case may be). e.g. "G1" refers to Garden Duplex 1 of Block A, B, C, D, E or F (as the case may be).
- In the description of residential property in a residential block, the prefix "P" means Penthouse Triplex unit and the numbering means the numbering of Penthouse Triplex unit of Block A, B, D, E or F (as the case may be). e.g. "P1" refers to Penthouse Triplex 1 of Block A, B, D, E or F (as the case may be).

備註:

- 住宅大樓的住宅物業的描述中，字首「G」指花園複式單位，而編號指A、B、C、D、E或F座(視情況而定)的花園複式單位的編號。例如「G1」指A、B、C、D、E或F座(視情況而定)的花園複式1號單位。
- 住宅大樓中住宅物業的描述中，字首「P」指頂層三複式單位，而編號指A、B、D、E或F座(視情況而定)的頂層三複式單位的編號。例如「P1」指A、B、D、E或F座(視情況而定)的頂層三複式1號單位。

Cross-section plan of building in the development

發展項目中的建築物的橫截面圖

Cross-Section Plan E1 橫截面圖 E1

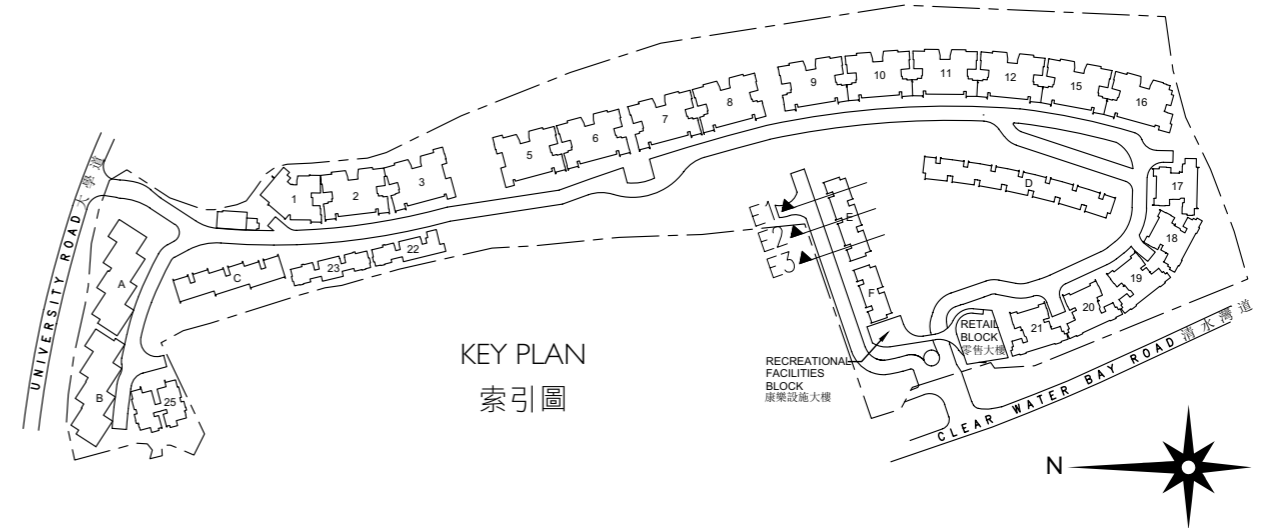
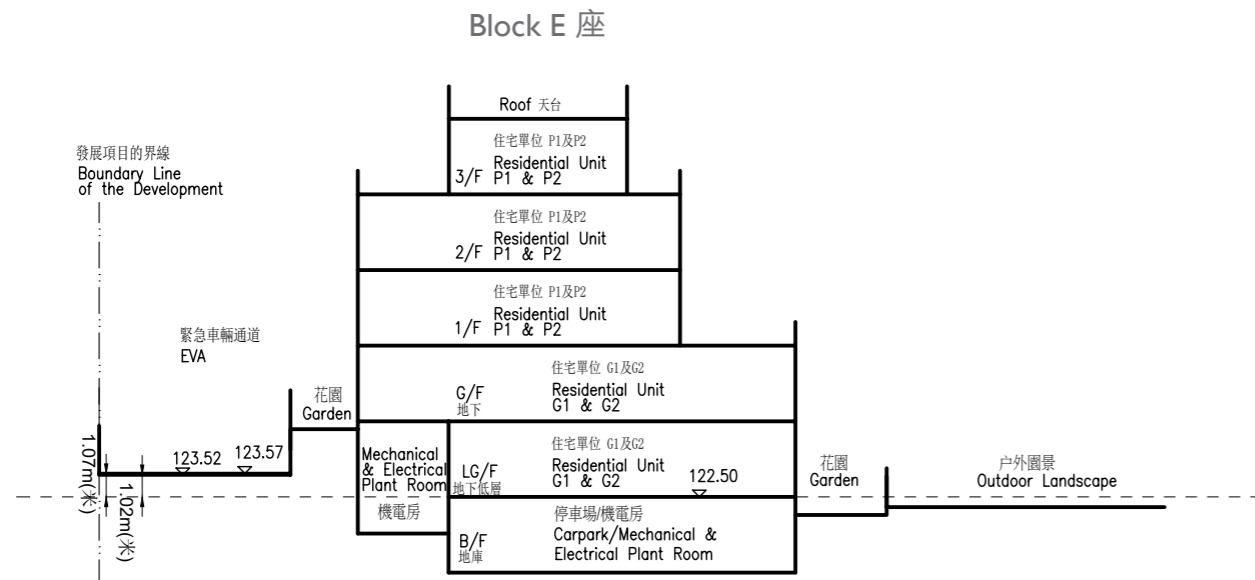

-- Dotted line denotes the lowest residential floor: 虛線為最低住宅樓層水平
EVA : Emergency Vehicular Access 緊急車輛通道

The part of Emergency Vehicular Access adjacent to the building is 123.52 to 123.57 metres above the Hong Kong Principal Datum. 毗連建築物的一段緊急車輛通道為香港主水平基準以上123.52至123.57米。

Cross-Section Plan E2 橫截面圖 E2

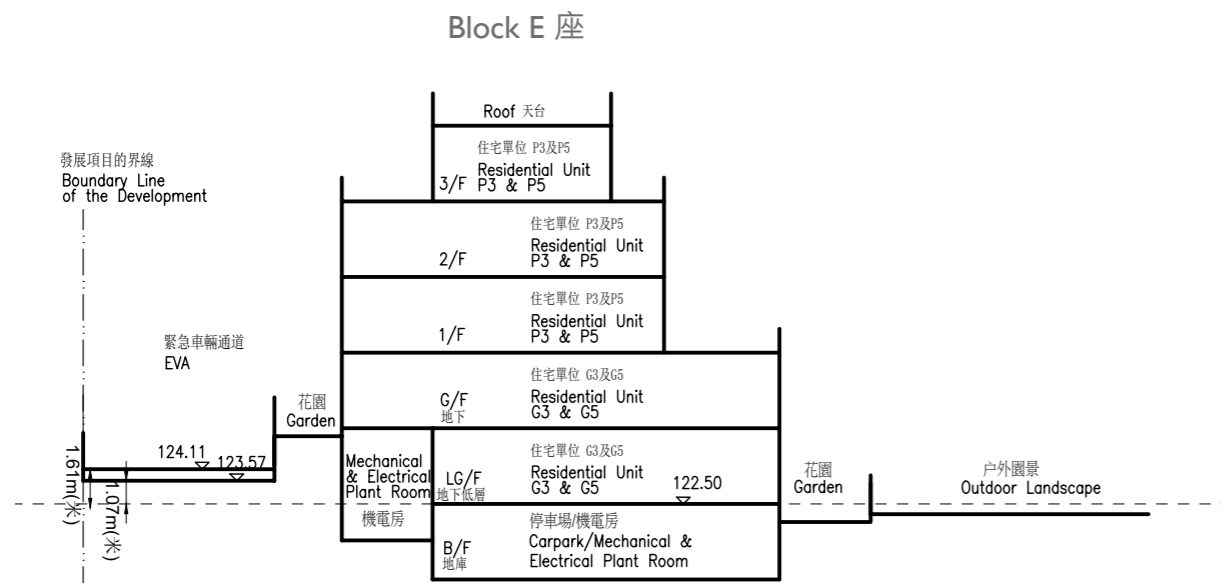

Cross-Section Plan E2 橫截面圖 E2

The part of Emergency Vehicular Access adjacent to the building is 123.57 to 124.11 metres above the Hong Kong Principal Datum. 毗連建築物的一段緊急車輛通道為香港主水平基準以上123.57至124.11米。

Remarks:

- In the description of residential property in a residential block, the prefix "G" means Garden Duplex unit and the numbering means the numbering of Garden Duplex unit of Block A, B, C, D, E or F (as the case may be). e.g. "G1" refers to Garden Duplex 1 of Block A, B, C, D, E or F (as the case may be).
- In the description of residential property in a residential block, the prefix "P" means Penthouse Triplex unit and the numbering means the numbering of Penthouse Triplex unit of Block A, B, D, E or F (as the case may be). e.g. "P1" refers to Penthouse Triplex 1 of Block A, B, D, E or F (as the case may be).

Cross-Section Plan E3 橫截面圖 E3

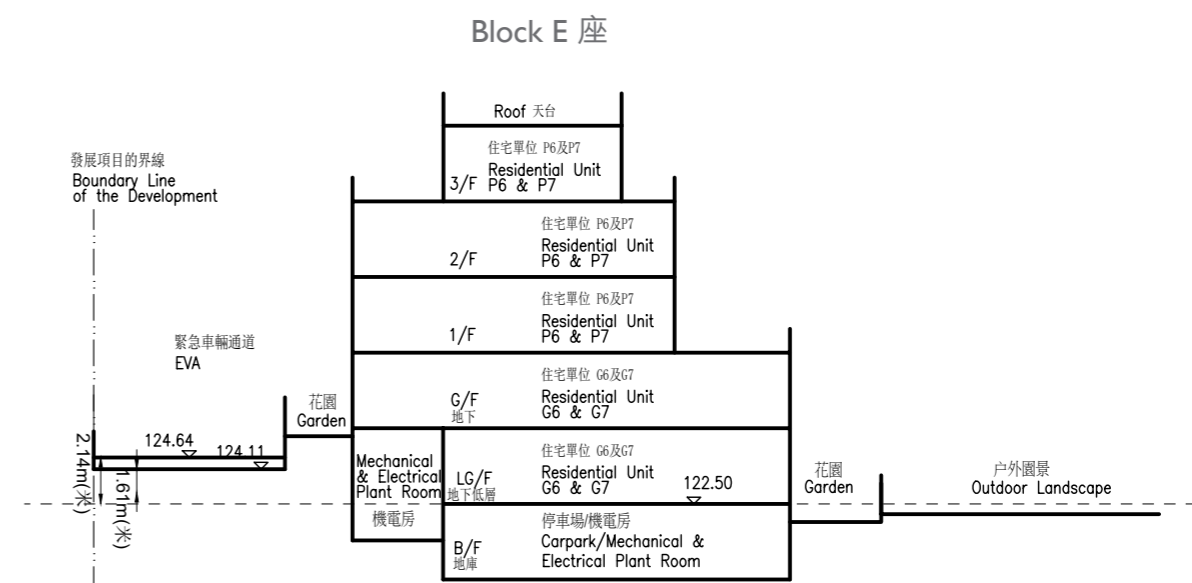

Cross-Section Plan E3 橫截面圖 E3

The part of Emergency Vehicular Access adjacent to the building is 124.11 to 124.64 metres above the Hong Kong Principal Datum. 毗連建築物的一段緊急車輛通道為香港主水平基準以上124.11至124.64米。

備註:

- 住宅大樓的住宅物業的描述中，字首「G」指花園複式單位，而編號指A、B、C、D、E或F座(視情況而定)的花園複式單位的編號。例如「G1」指A、B、C、D、E或F座(視情況而定)的花園複式1號單位。
- 住宅大樓中住宅物業的描述中，字首「P」指頂層三複式單位，而編號指A、B、D、E或F座(視情況而定)的頂層三複式單位的編號。例如「P1」指A、B、D、E或F座(視情況而定)的頂層三複式1號單位。

Cross-section plan of building in the development

發展項目中的建築物的橫截面圖

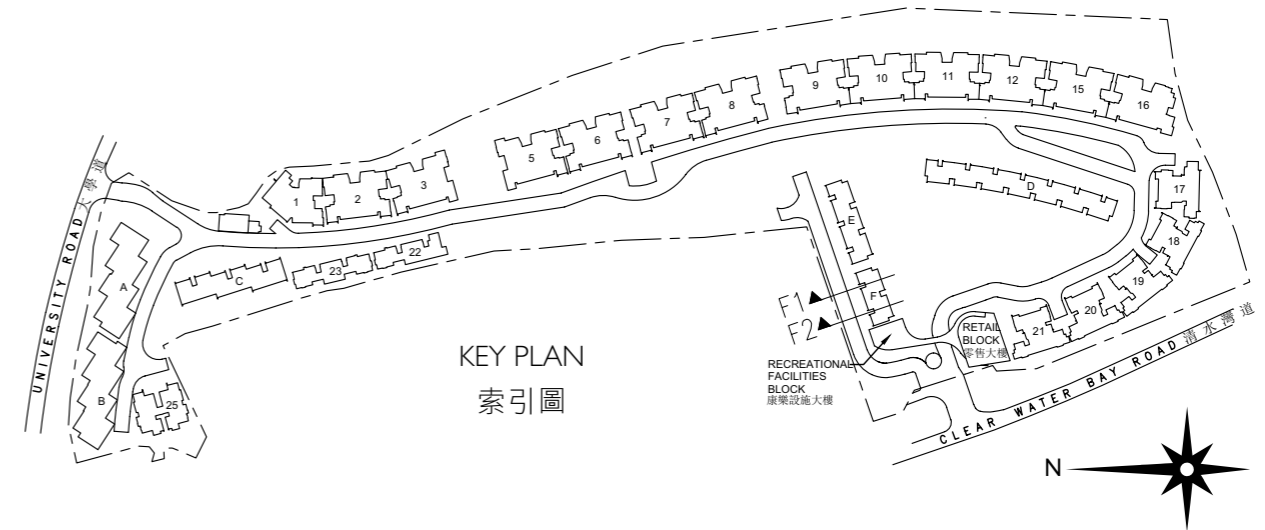

-- Dotted line denotes the lowest residential floor. 虛線為最低住宅樓層水平
EVA : Emergency Vehicular Access 緊急車輛通道

Cross-Section Plan F1 橫截面圖 F1

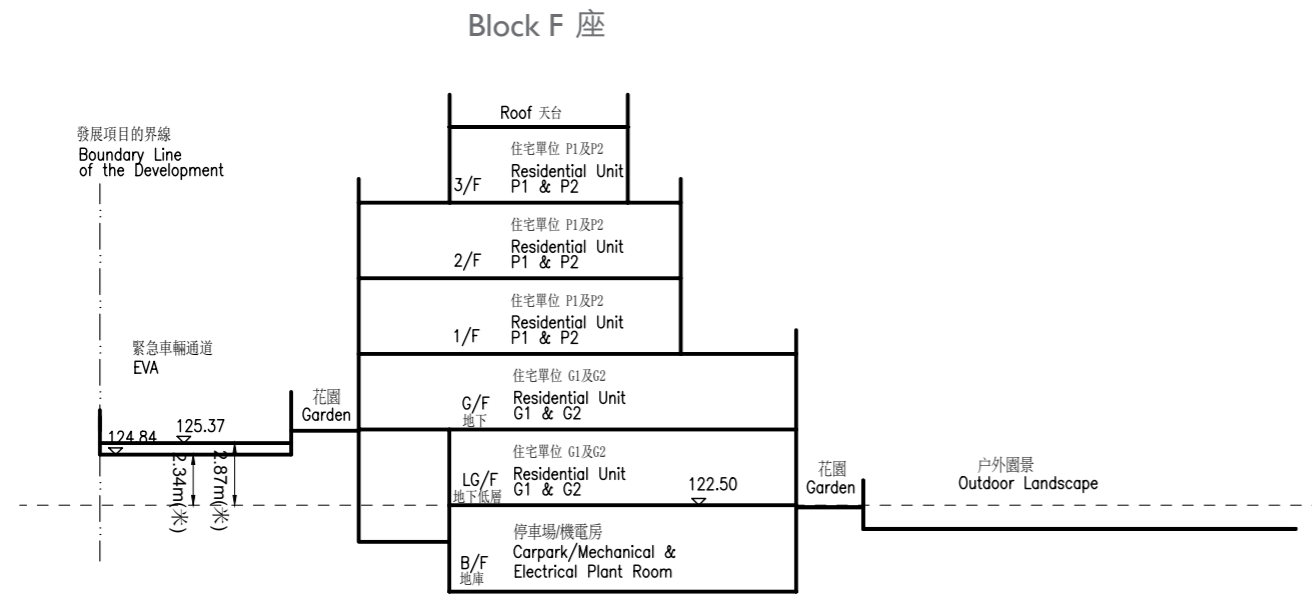

Cross-Section Plan F1 橫截面圖 F1

The part of Emergency Vehicular Access adjacent to the building is 124.84 to 125.37 metres above the Hong Kong Principal Datum. 毗連建築物的一段緊急車輛通道為香港主水平基準以上124.84至125.37米。

Remarks:

- In the description of residential property in a residential block, the prefix "G" means Garden Duplex unit and the numbering means the numbering of Garden Duplex unit of Block A, B, C, D, E or F (as the case may be). e.g. "G1" refers to Garden Duplex 1 of Block A, B, C, D, E or F (as the case may be).
- In the description of residential property in a residential block, the prefix "P" means Penthouse Triplex unit and the numbering means the numbering of Penthouse Triplex unit of Block A, B, D, E or F (as the case may be). e.g. "P1" refers to Penthouse Triplex 1 of Block A, B, D, E or F (as the case may be).

Cross-Section Plan F2 橫截面圖 F2

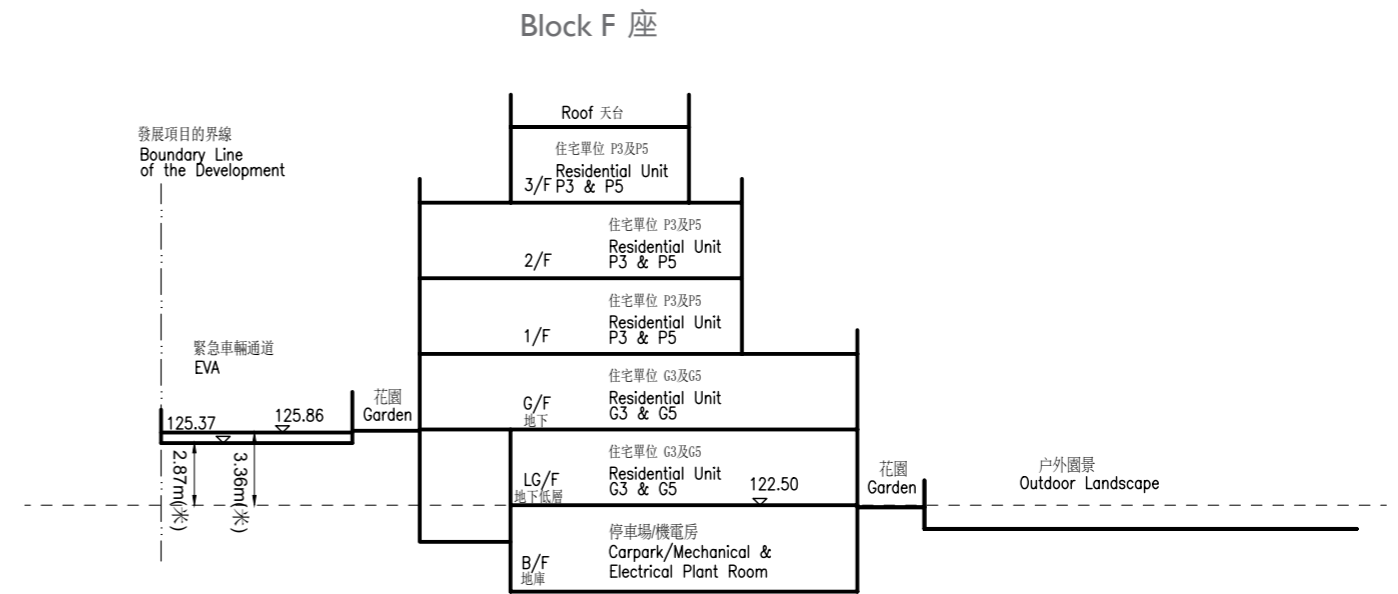

Cross-Section Plan F2 橫截面圖 F2

The part of Emergency Vehicular Access adjacent to the building is 125.37 to 125.86 metres above the Hong Kong Principal Datum. 毗連建築物的一段緊急車輛通道為香港主水平基準以上125.37至125.86米。

備註:

- 住宅大樓的住宅物業的描述中，字首「G」指花園複式單位，而編號指A、B、C、D、E或F座(視情況而定)的花園複式單位的編號。例如「G1」指A、B、C、D、E或F座(視情況而定)的花園複式1號單位。
- 住宅大樓中住宅物業的描述中，字首「P」指頂層三複式單位，而編號指A、B、D、E或F座(視情況而定)的頂層三複式單位的編號。例如「P1」指A、B、D、E或F座(視情況而定)的頂層三複式1號單位。

Cross-section plan of building in the development

發展項目中的建築物的橫截面圖

Cross-Section Plan 1 橫截面圖 1

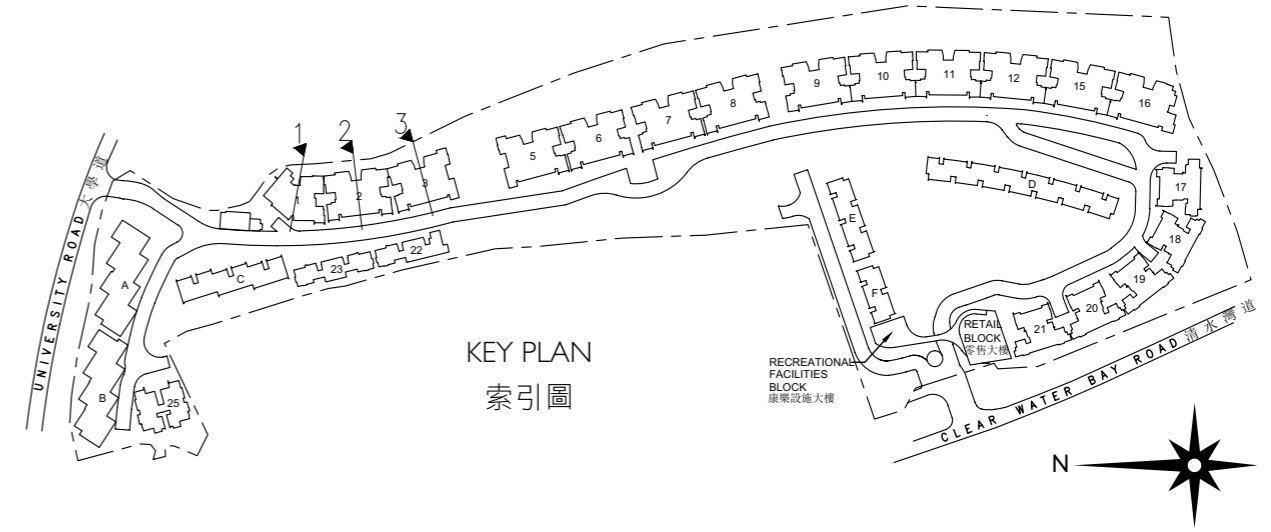
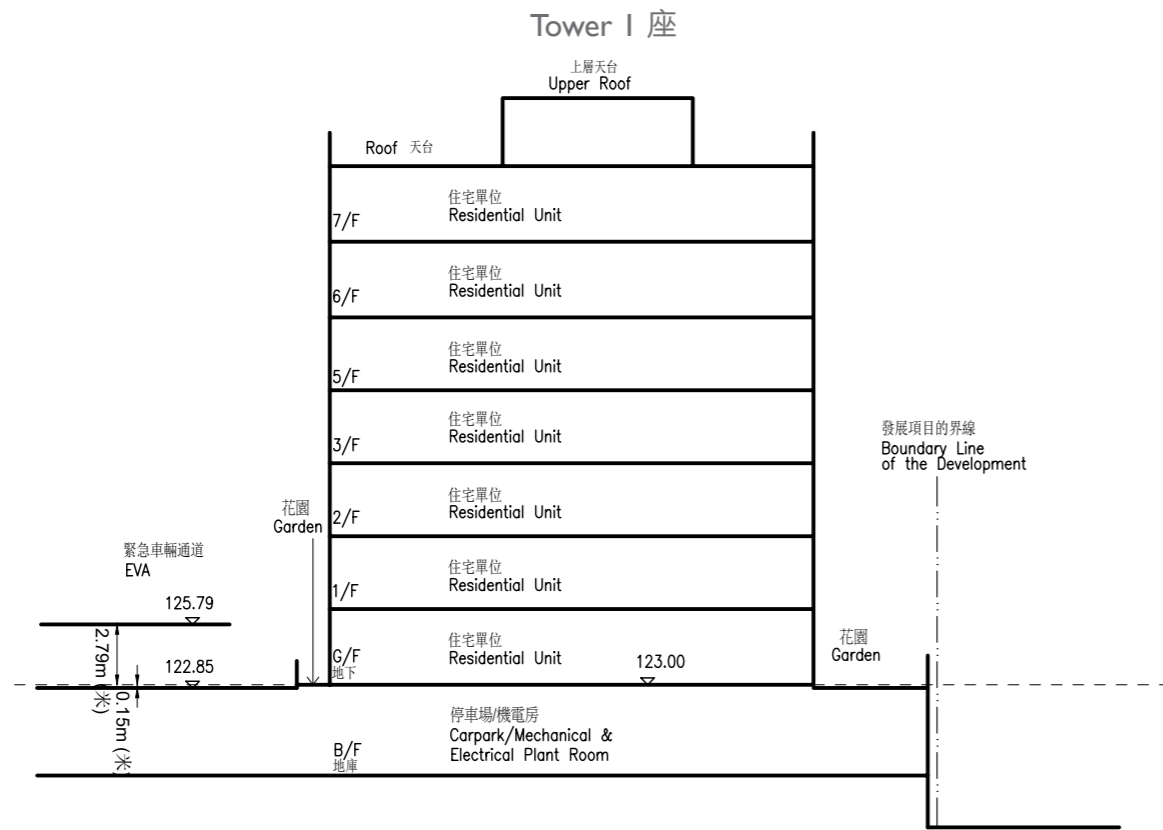

-- Dotted line denotes the lowest residential floor: 虛線為最低住宅樓層水平
EVA : Emergency Vehicular Access 緊急車輛通道

The part of Emergency Vehicular Access adjacent to the building is 122.85 to 125.79 metres above the Hong Kong Principal Datum. 毗連建築物的一段緊急車輛通道為香港主水平基準以上122.85至125.79米。

Cross-Section Plan 2 橫截面圖 2

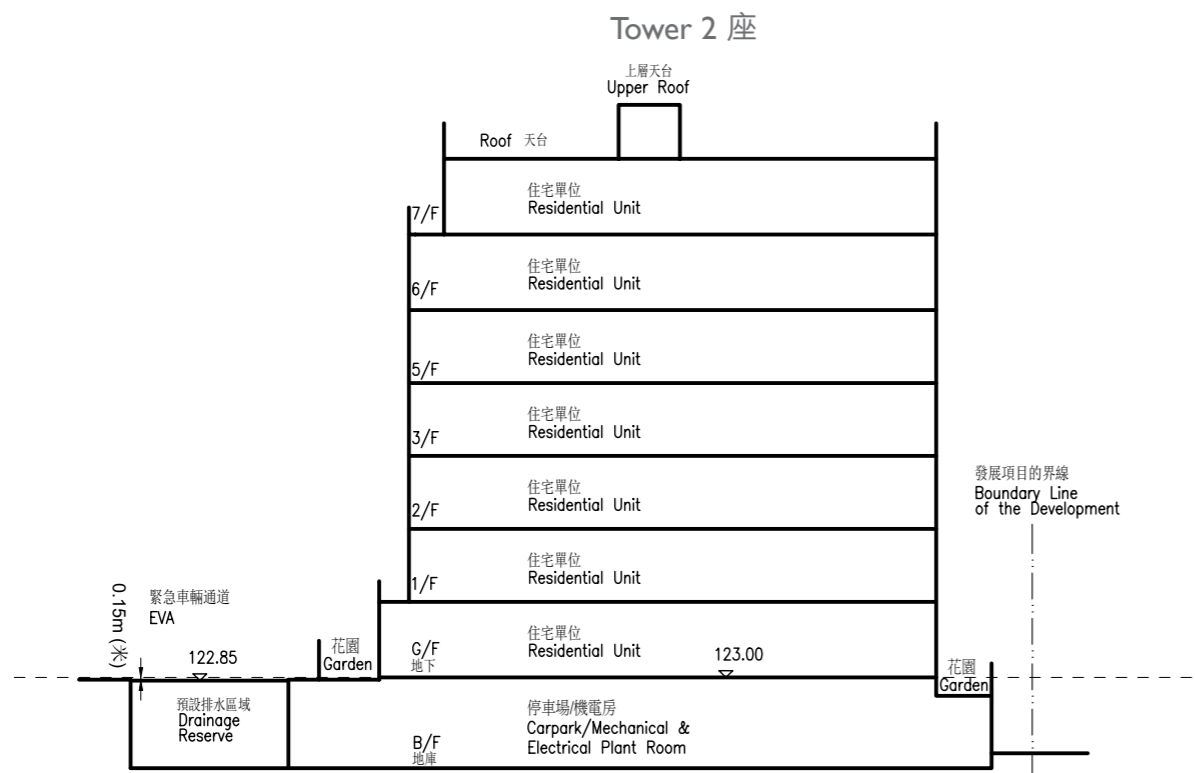

The part of Emergency Vehicular Access adjacent to the building is 122.85 metres above the Hong Kong Principal Datum. 毗連建築物的一段緊急車輛通道為香港主水平基準以上122.85米。

Cross-Section Plan 3 橫截面圖 3

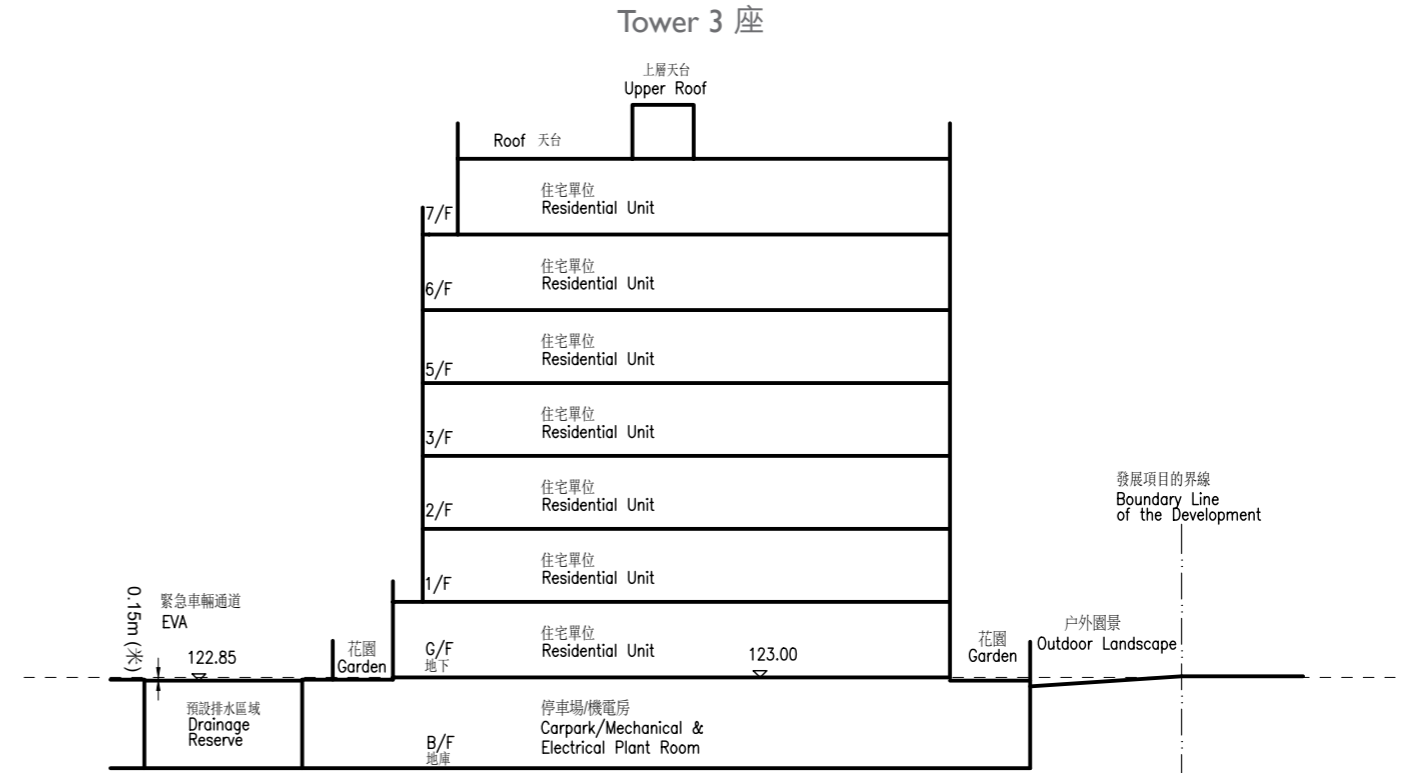

The part of Emergency Vehicular Access adjacent to the building is 122.85 metres above the Hong Kong Principal Datum. 毗連建築物的一段緊急車輛通道為香港主水平基準以上122.85米。

Cross-section plan of building in the development

發展項目中的建築物的橫截面圖

Cross-Section Plan 4 橫截面圖 4

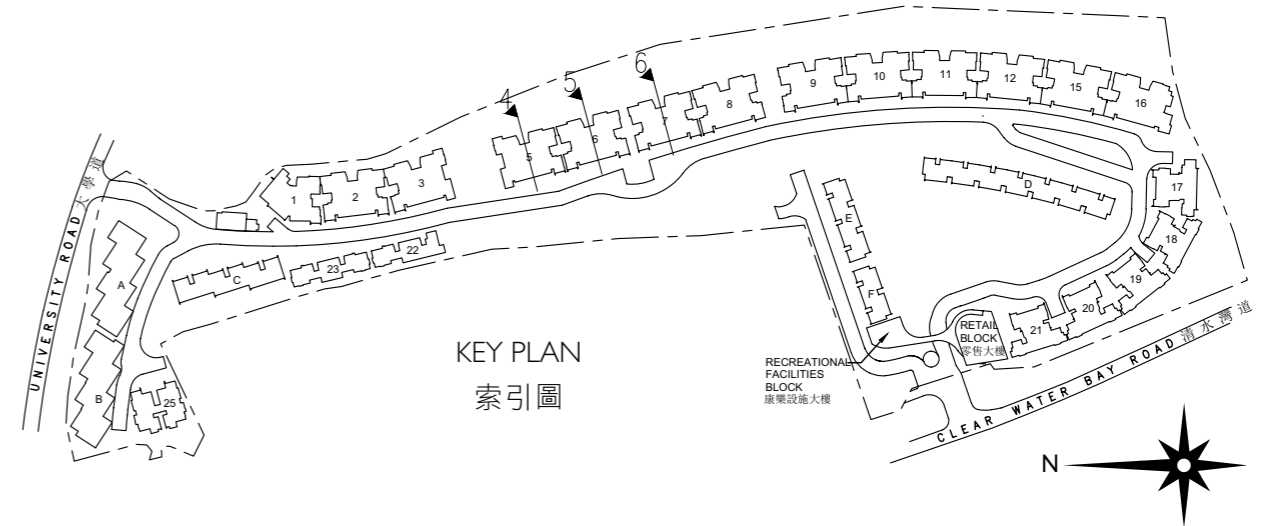
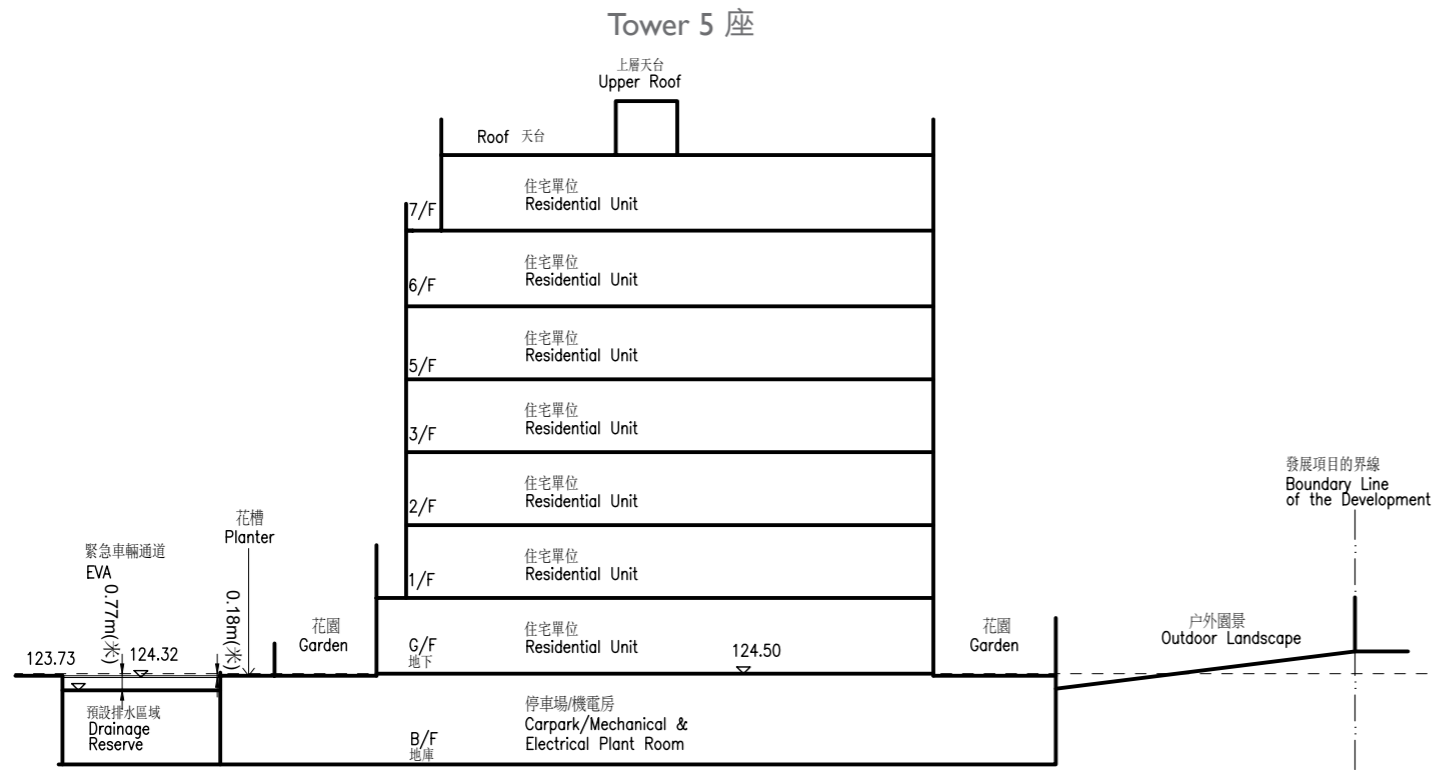

-- Dotted line denotes the lowest residential floor. 虛線為最低住宅樓層水平
EVA : Emergency Vehicular Access 緊急車輛通道

The part of Emergency Vehicular Access adjacent to the building is 123.73 to 124.32 metres above the Hong Kong Principal Datum. 毗連建築物的一段緊急車輛通道為香港主水平基準以上123.73至124.32米。

Cross-Section Plan 5 橫截面圖 5

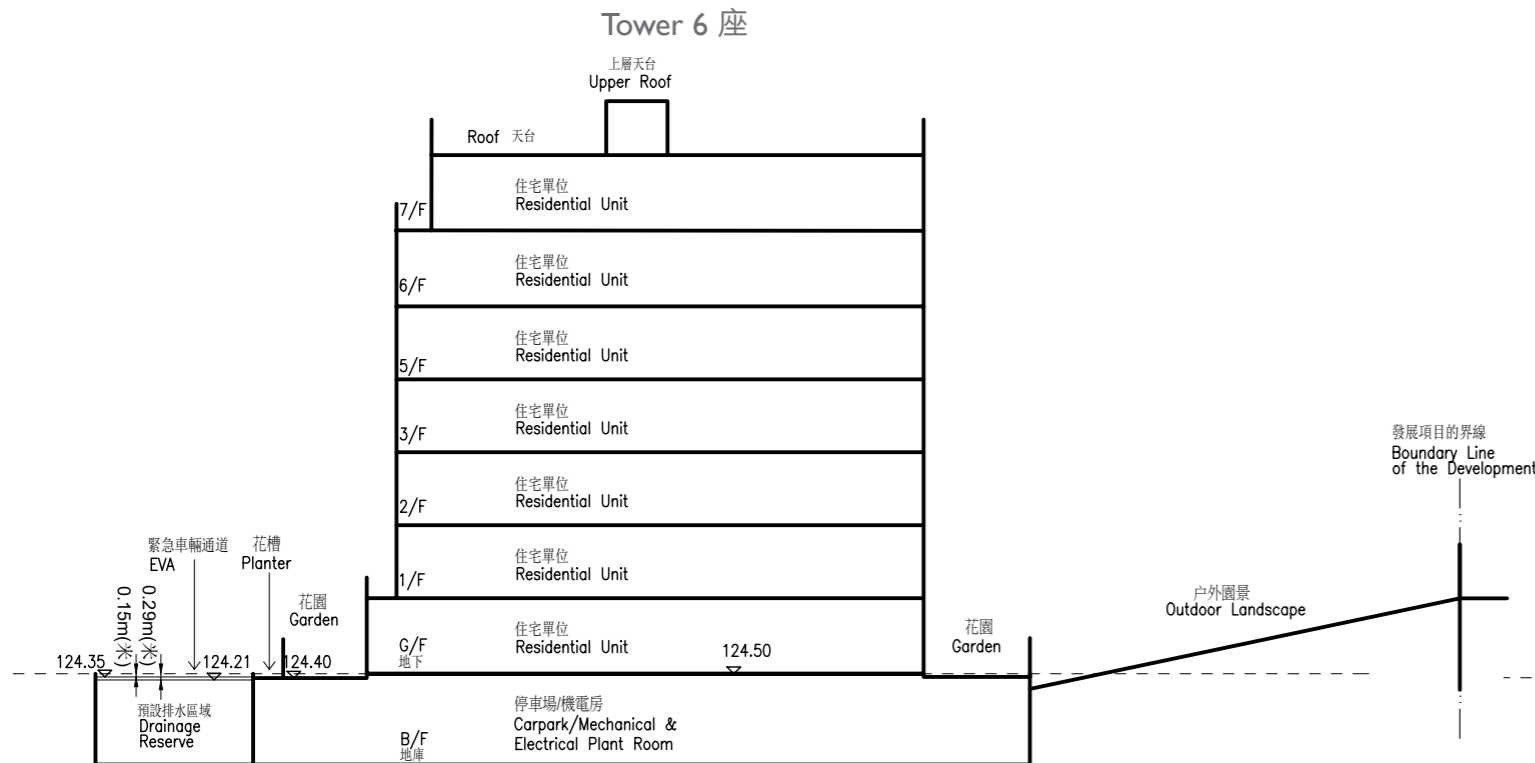

The part of Emergency Vehicular Access adjacent to the building is 124.21 to 124.35 metres above the Hong Kong Principal Datum. 毗連建築物的一段緊急車輛通道為香港主水平基準以上124.21米至124.35米。

Cross-Section Plan 6 橫截面圖 6

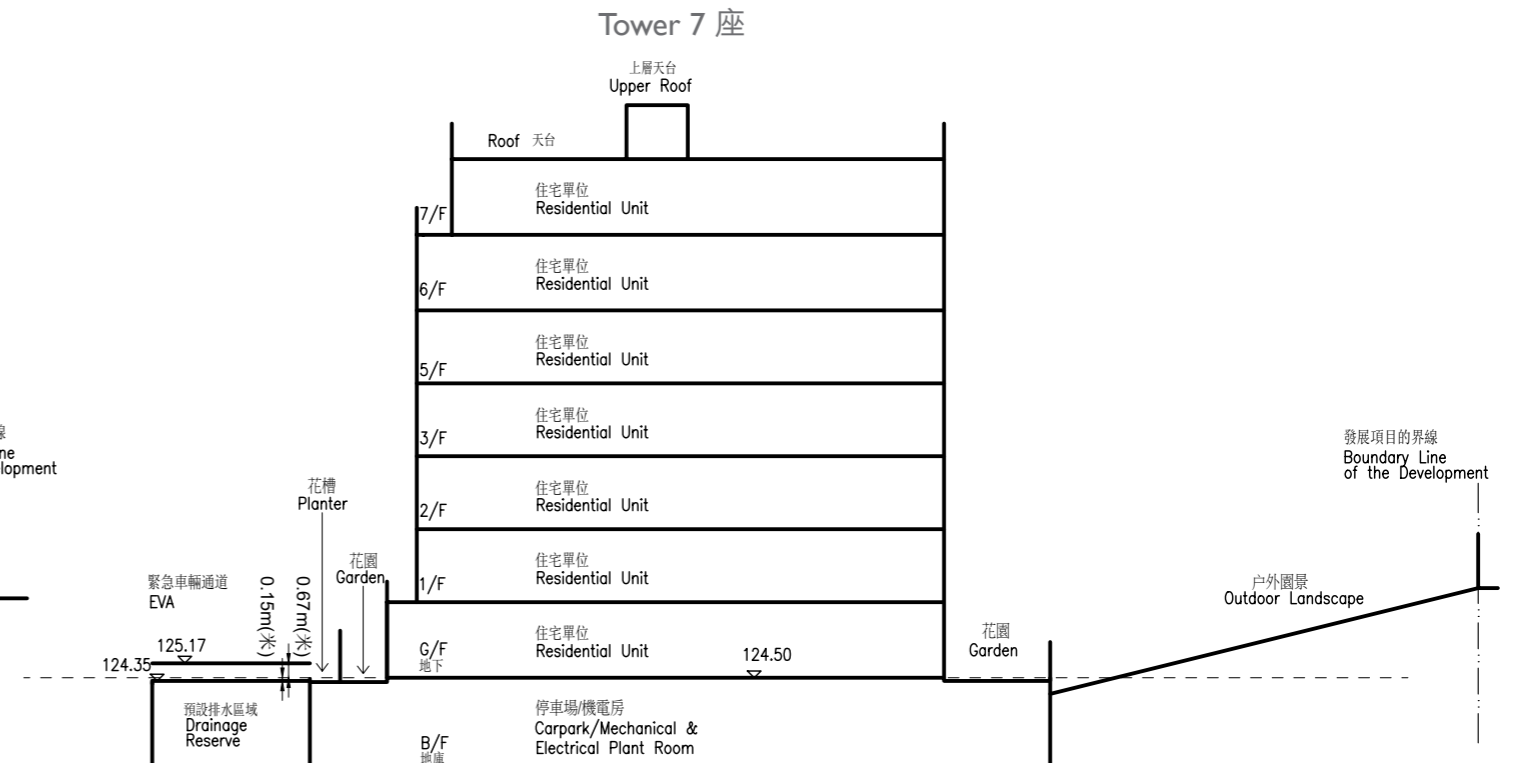

The part of Emergency Vehicular Access adjacent to the building is 124.35 to 125.17 metres above the Hong Kong Principal Datum. 毗連建築物的一段緊急車輛通道為香港主水平基準以上124.35至125.17米。

Cross-section plan of building in the development

發展項目中的建築物的橫截面圖

Cross-Section Plan 7 橫截面圖 7

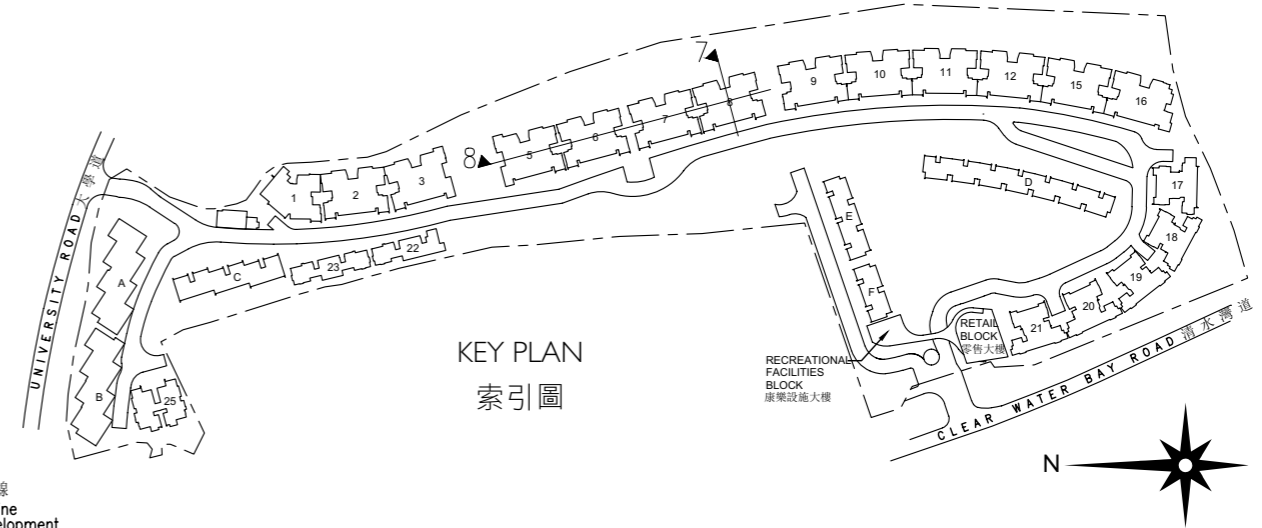
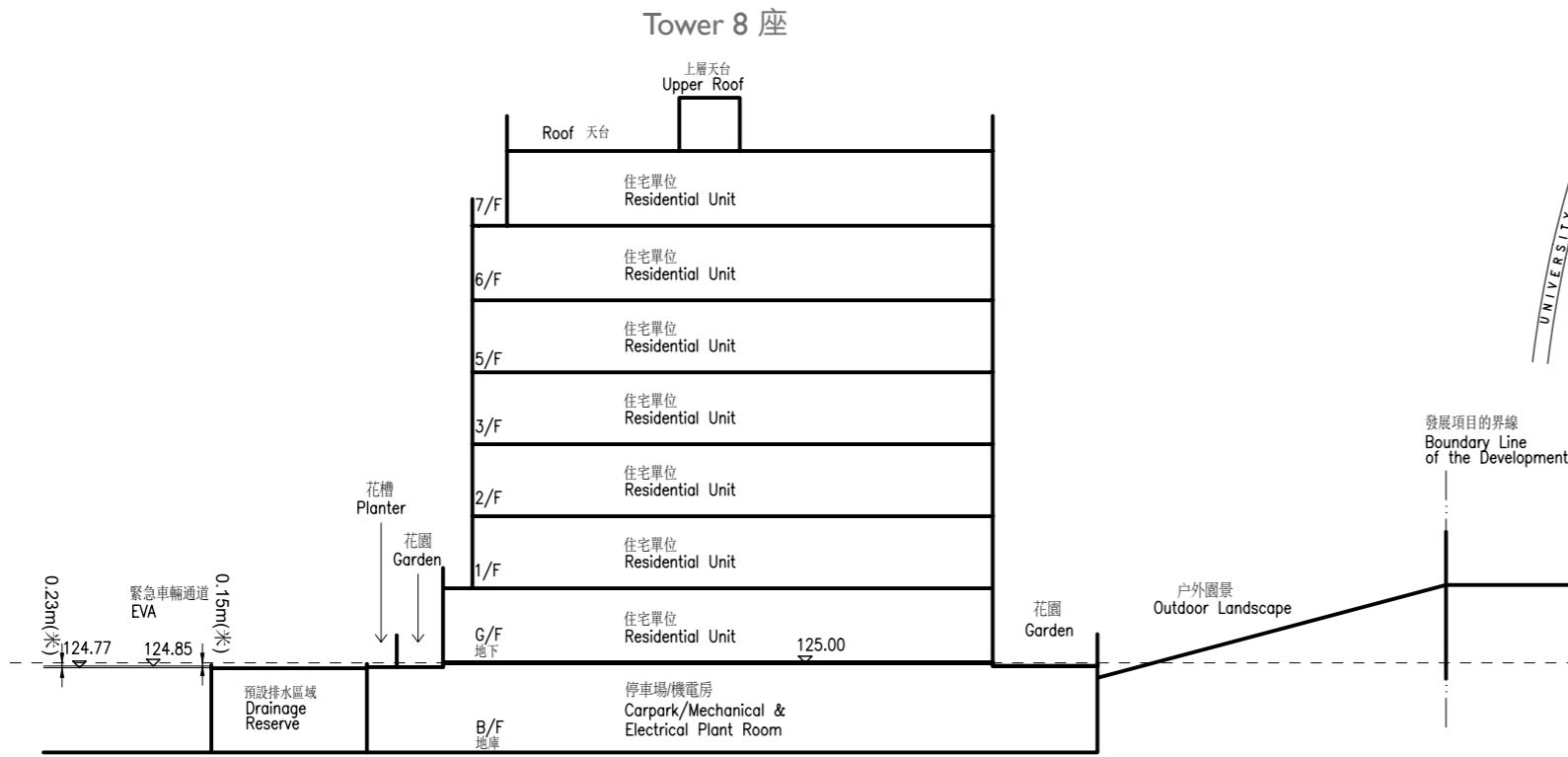

-- Dotted line denotes the lowest residential floor: 虛線為最低住宅樓層水平
EVA : Emergency Vehicular Access 緊急車輛通道

The part of Emergency Vehicular Access adjacent to the building is 124.77 to 124.85 metres above the Hong Kong Principal Datum. 毗連建築物的一段緊急車輛通道為香港主水平基準以上124.77至124.85米。

Cross-Section Plan 8 橫截面圖 8

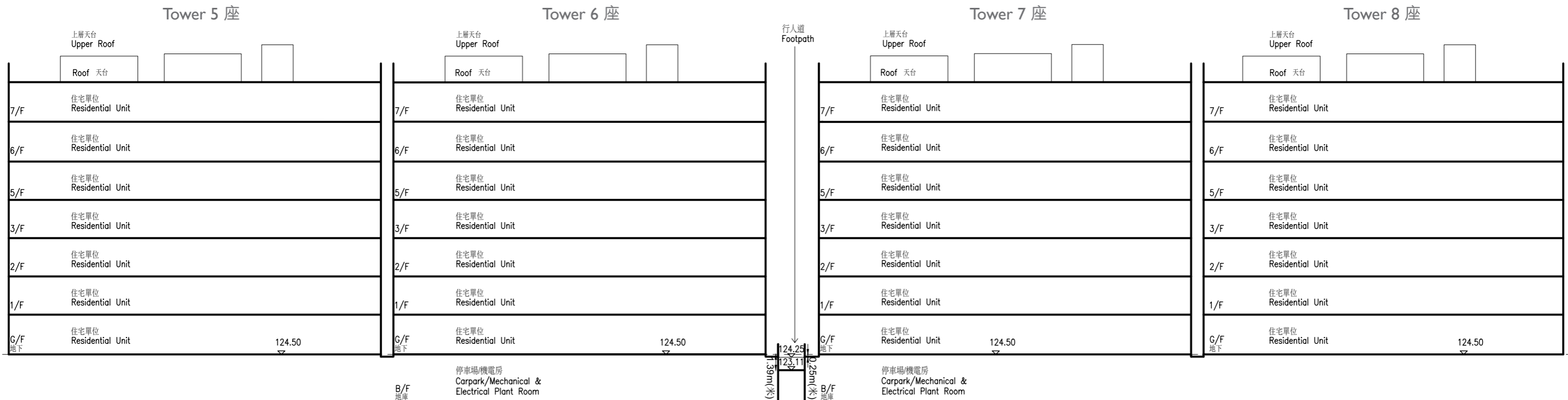

Footpath
The part of Footpath adjacent to the building is 123.11 to 124.25 metres above Hong Kong Principal Datum.

行人道
毗連建築物的一段行人道為香港主水平基準以上123.11至124.25米。

Cross-section plan of building in the development

發展項目中的建築物的橫截面圖

Cross-Section Plan 9 橫截面圖 9

Tower 9 座

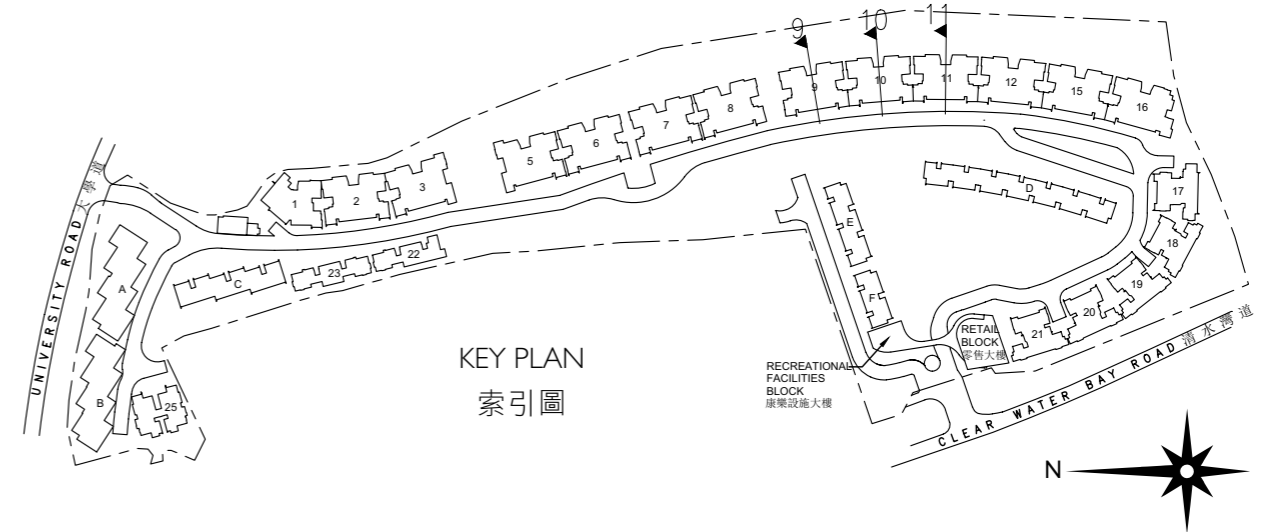
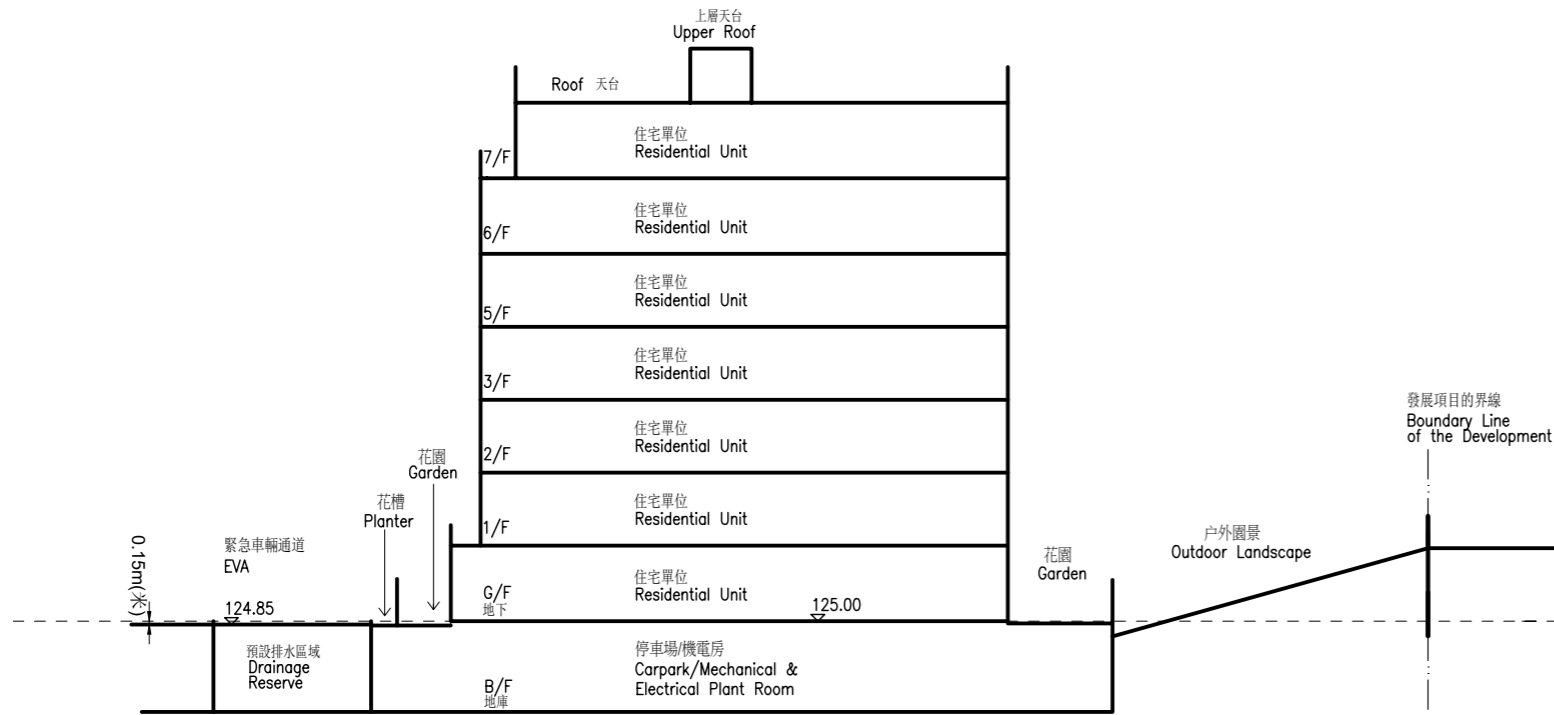

-- Dotted line denotes the lowest residential floor. 虛線為最低住宅樓層水平
EVA : Emergency Vehicular Access 緊急車輛通道

The part of Emergency Vehicular Access adjacent to the building is 124.85 metres above the Hong Kong Principal Datum.

毗連建築物的一段緊急車輛通道為香港主水平基準以上124.85米。

Cross-Section Plan 10 橫截面圖 10

Tower 10 座

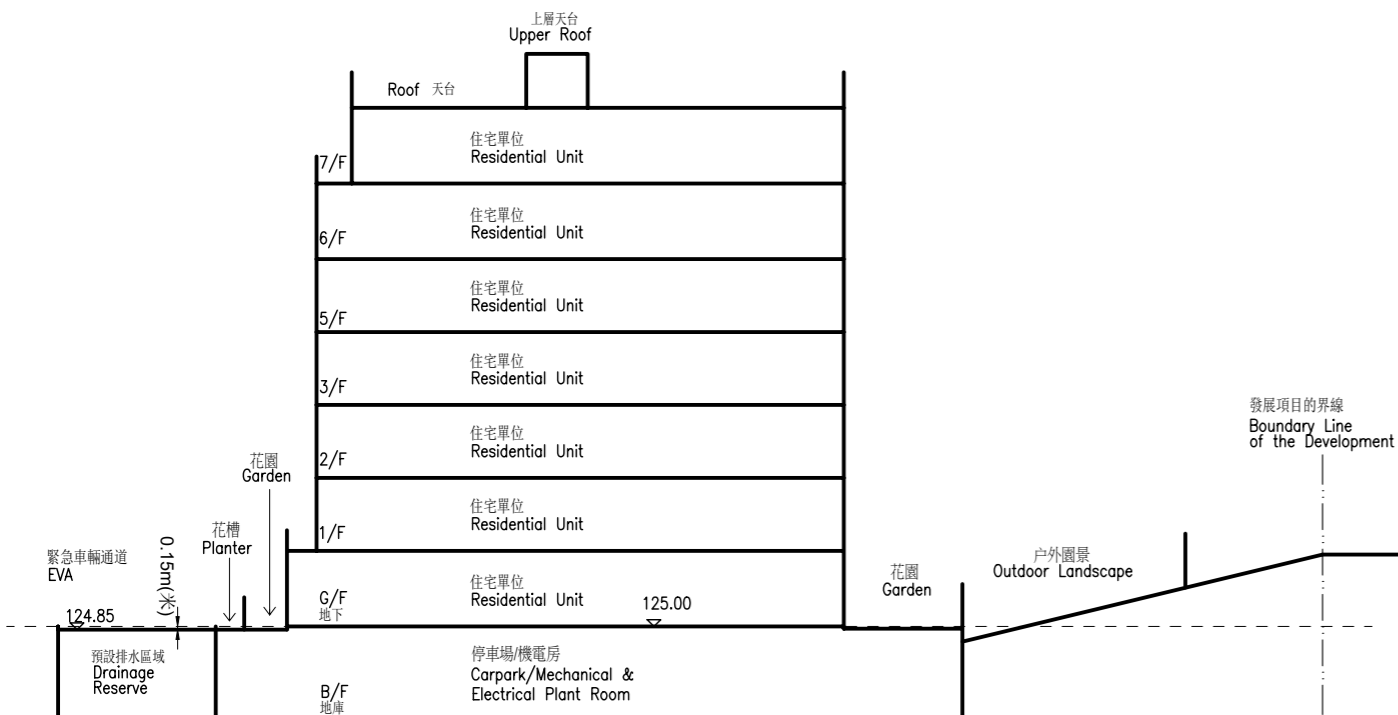

The part of Emergency Vehicular Access adjacent to the building is 124.85 metres above the Hong Kong Principal Datum.

毗連建築物的一段緊急車輛通道為香港主水平基準以上124.85米。

Cross-Section Plan 11 橫截面圖 11

Tower 11 座

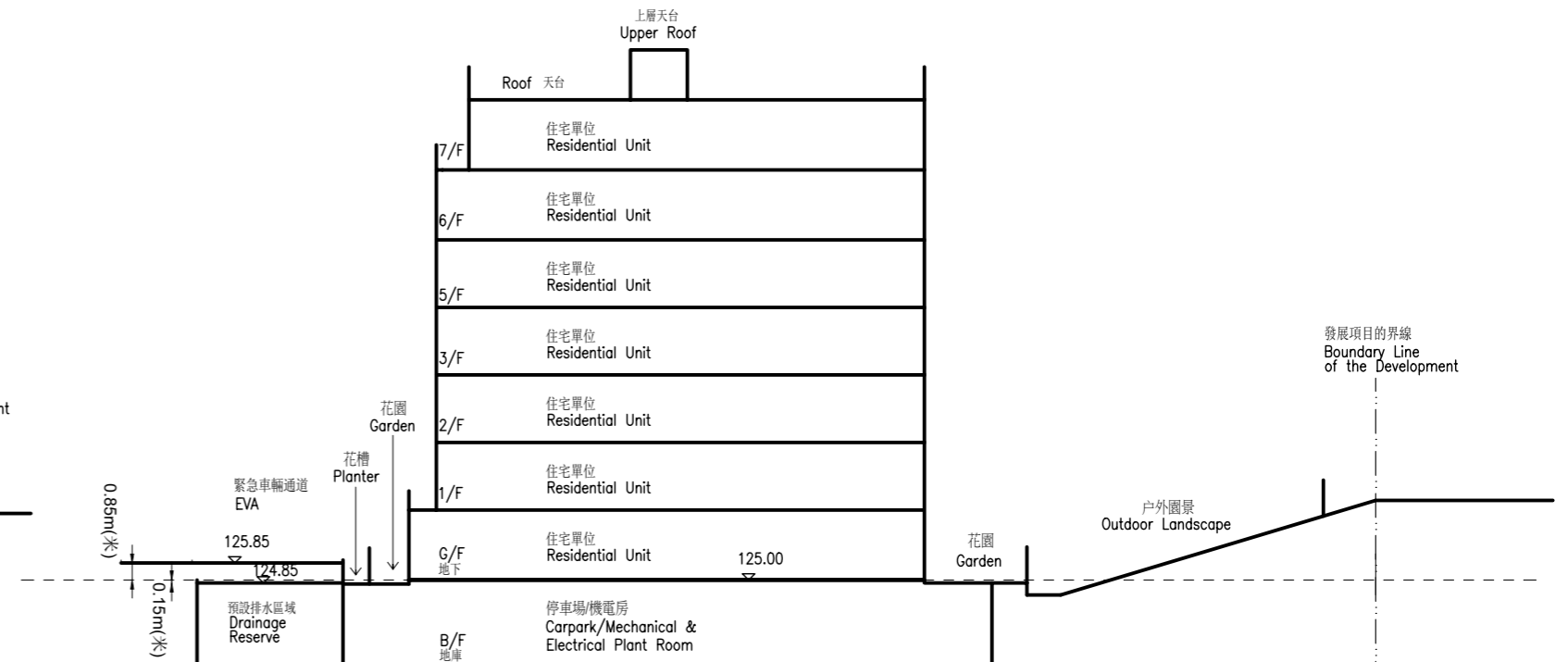

The part of Emergency Vehicular Access adjacent to the building is 124.85 to 125.85 metres above the Hong Kong Principal Datum.

毗連建築物的一段緊急車輛通道為香港主水平基準以上124.85至125.85米。

Cross-section plan of building in the development

發展項目中的建築物的橫截面圖

Cross-Section Plan 12 橫截面圖 12

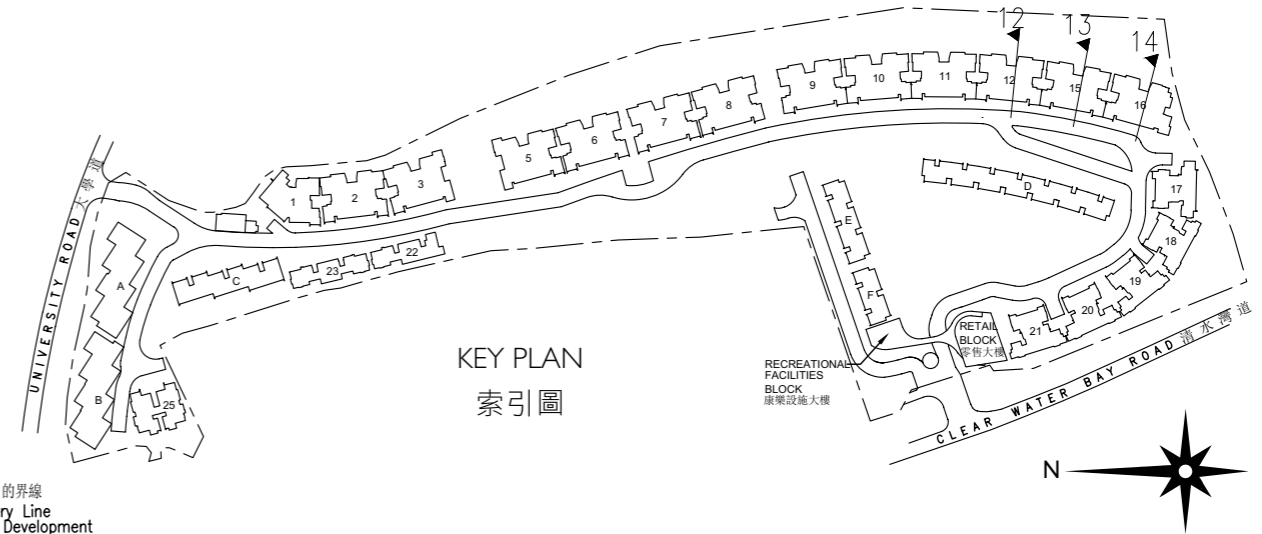
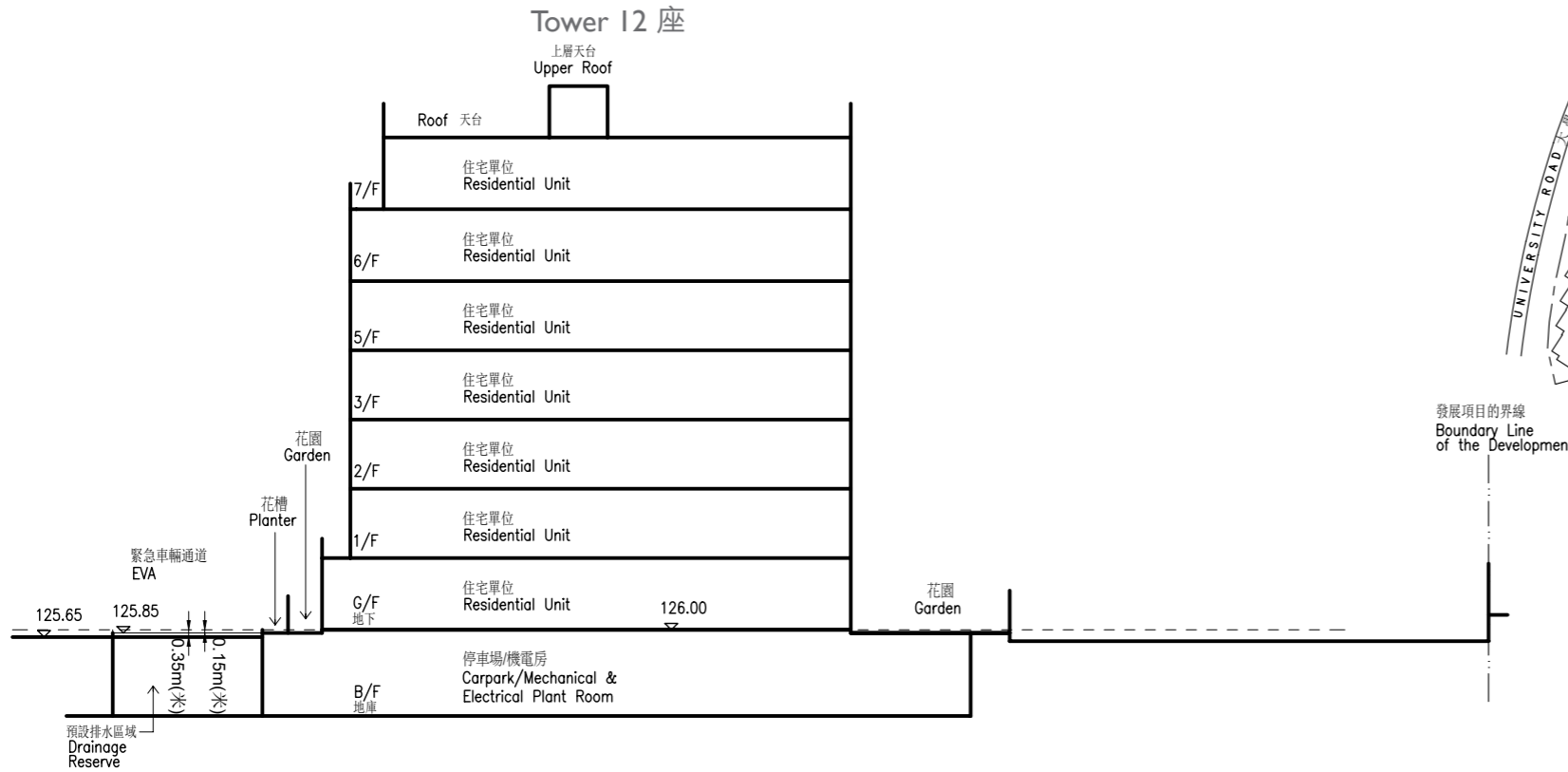

-- Dotted line denotes the lowest residential floor: 虛線為最低住宅樓層水平
 EVA : Emergency Vehicular Access 緊急車輛通道

The part of Emergency Vehicular Access adjacent to the building is 125.65 to 125.85 metres above the Hong Kong Principal Datum. 毗連建築物的一段緊急車輛通道為香港主水平基準以上125.65至125.85米。

Cross-Section Plan 13 橫截面圖 13

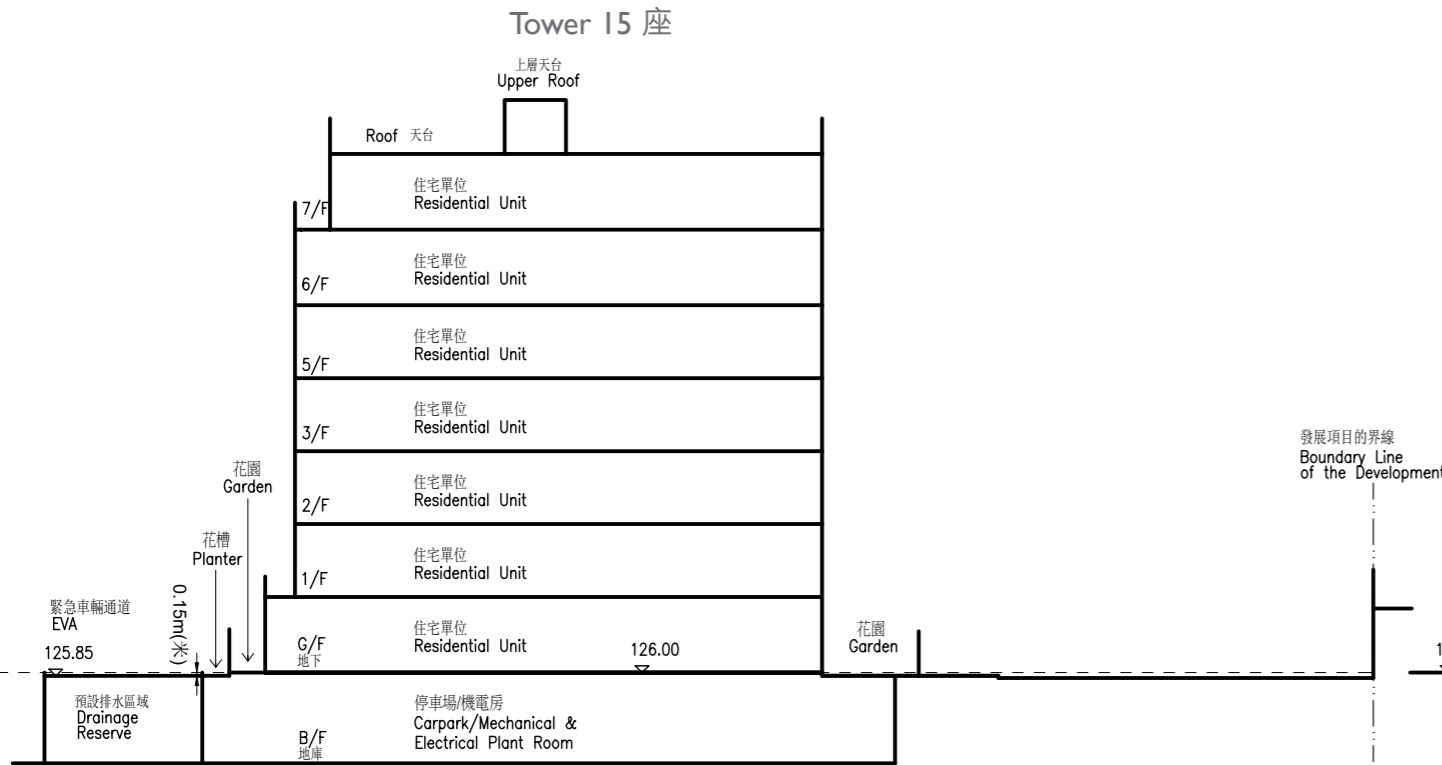

The part of Emergency Vehicular Access adjacent to the building is 125.85 metres above the Hong Kong Principal Datum. 毗連建築物的一段緊急車輛通道為香港主水平基準以上125.85米。

Cross-Section Plan 14 橫截面圖 14

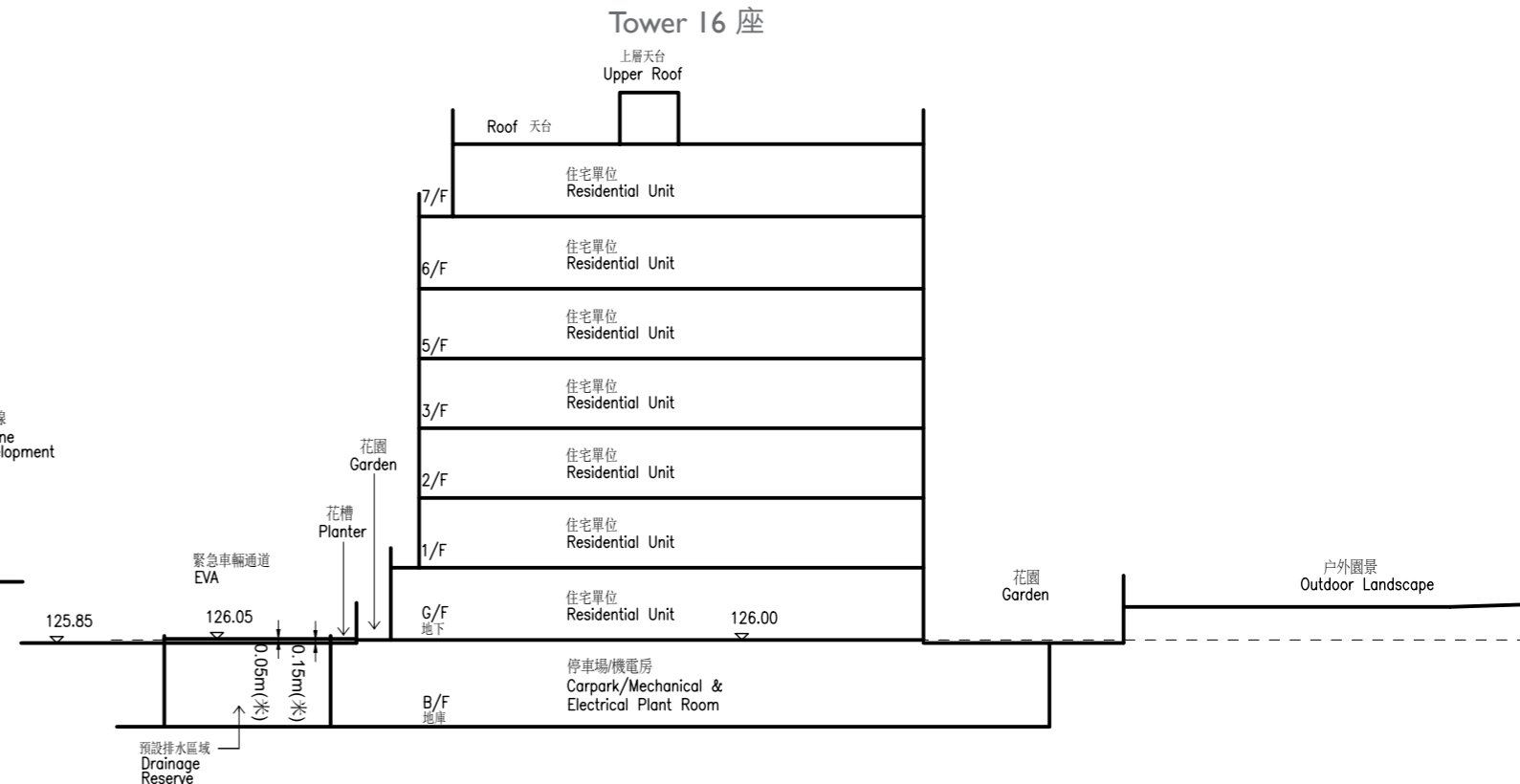

The part of Emergency Vehicular Access adjacent to the building is 125.85 to 126.05 metres above the Hong Kong Principal Datum. 毗連建築物的一段緊急車輛通道為香港主水平基準以上125.85至126.05米。

Cross-section plan of building in the development

發展項目中的建築物的橫截面圖

Cross-Section Plan 15 橫截面圖 15

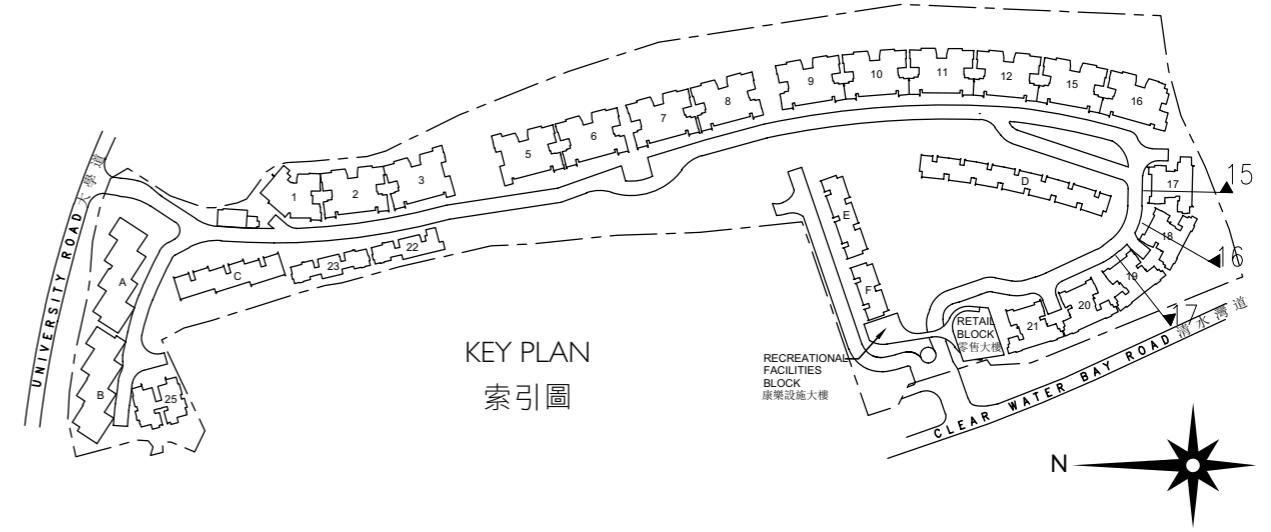
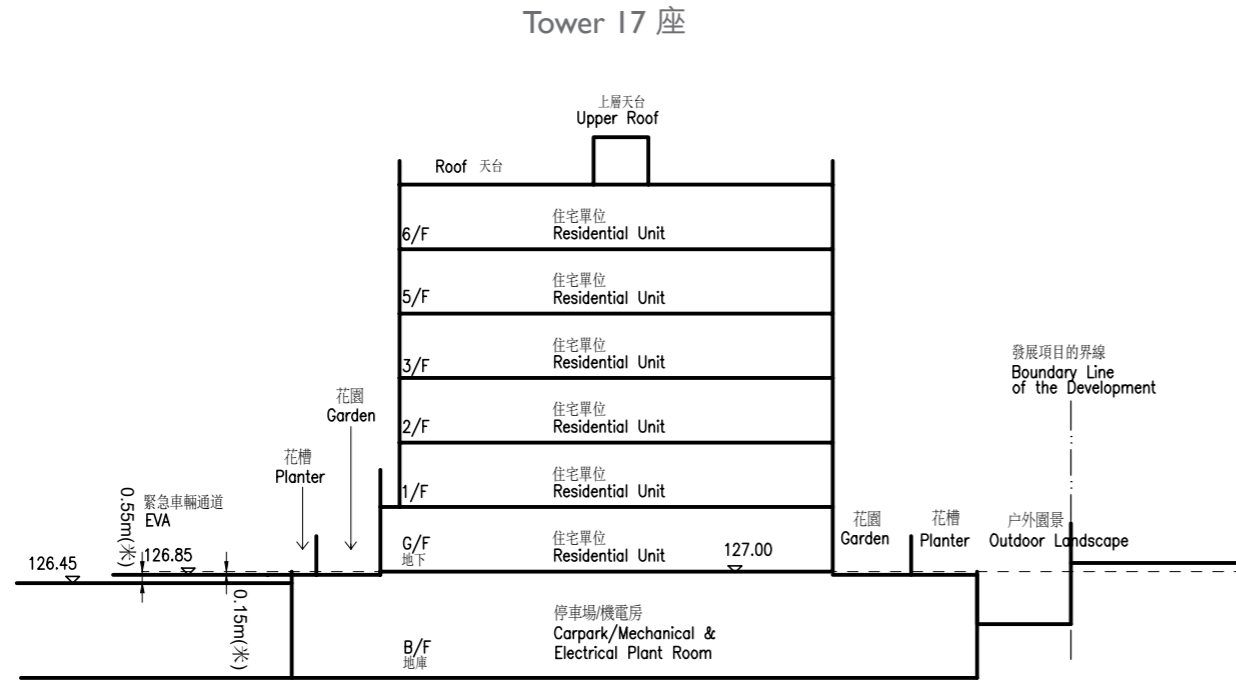

-- Dotted line denotes the lowest residential floor. 虛線為最低住宅樓層水平
EVA : Emergency Vehicular Access 緊急車輛通道

The part of Emergency Vehicular Access adjacent to the building is 126.45 to 126.85 metres above the Hong Kong Principal Datum. 毗連建築物的一段緊急車輛通道為香港主水平基準以上126.45至126.85米。

Cross-Section Plan 16 橫截面圖 16

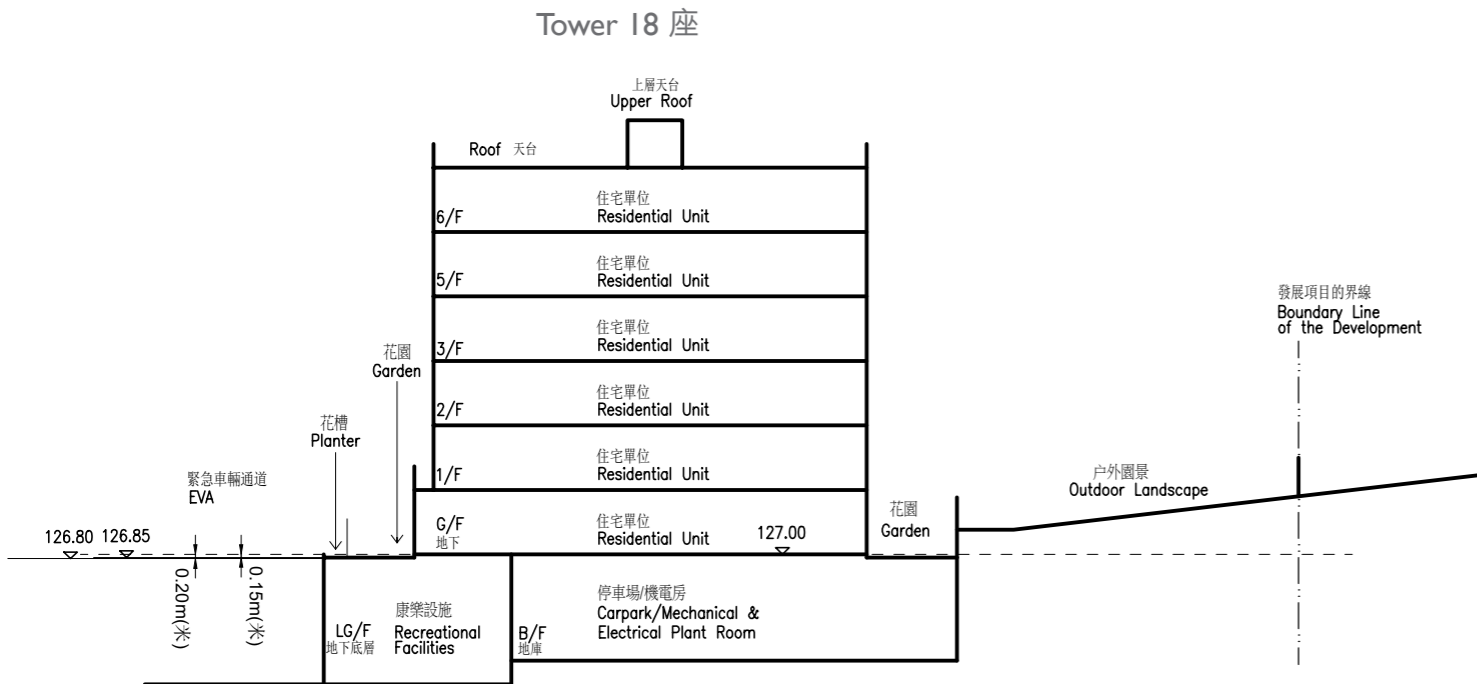

The part of Emergency Vehicular Access adjacent to the building is 126.80 to 126.85 metres above the Hong Kong Principal Datum. 毗連建築物的一段緊急車輛通道為香港主水平基準以上126.80至126.85米。

Cross-Section Plan 17 橫截面圖 17

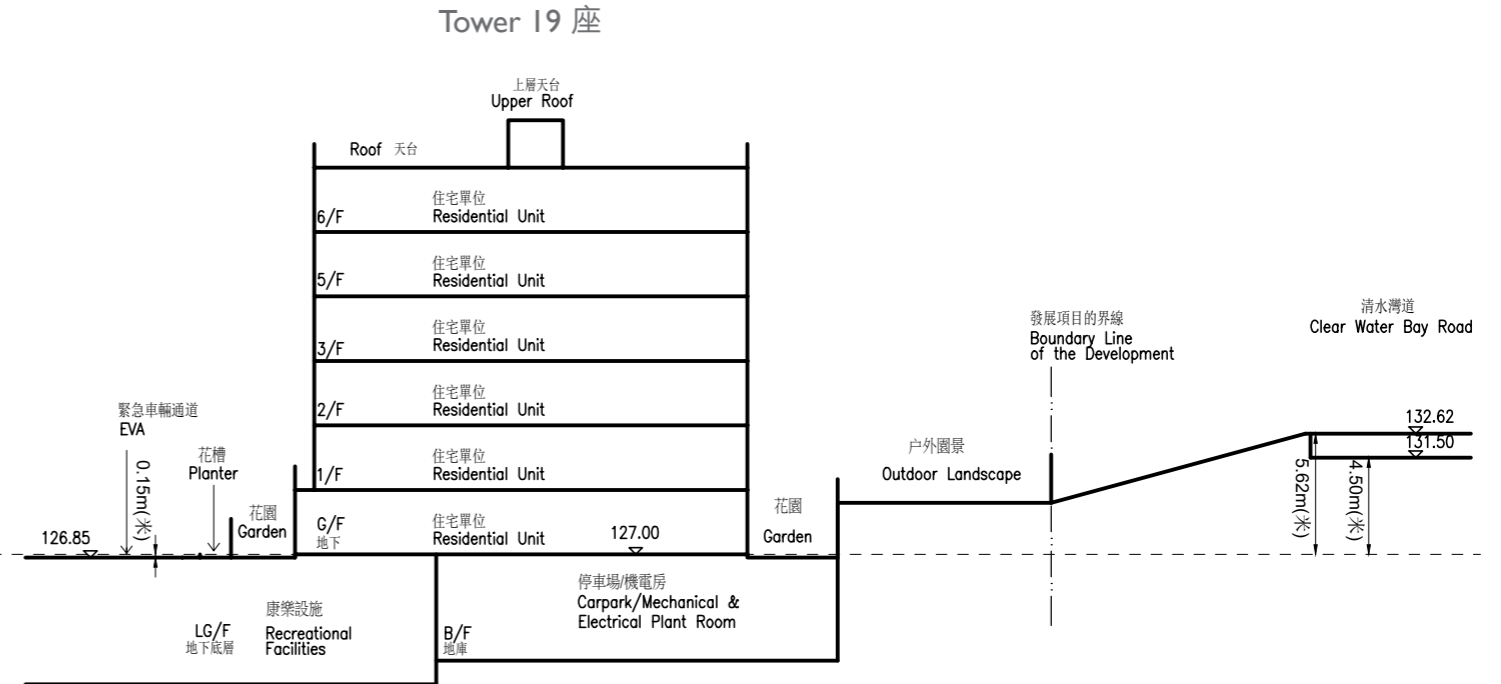

The part of Emergency Vehicular Access adjacent to the building is 126.85 metres above the Hong Kong Principal Datum. 毗連建築物的一段緊急車輛通道為香港主水平基準以上126.85米。

The part of Clearwater Bay Road adjacent to the building is 131.50 to 132.62 metres above the Hong Kong Principal Datum. 毗連建築物的一段清水灣道為香港主水平基準以上131.50至132.62米。

Cross-section plan of building in the development

發展項目中的建築物的橫截面圖

Cross-Section Plan 18 橫截面圖 18

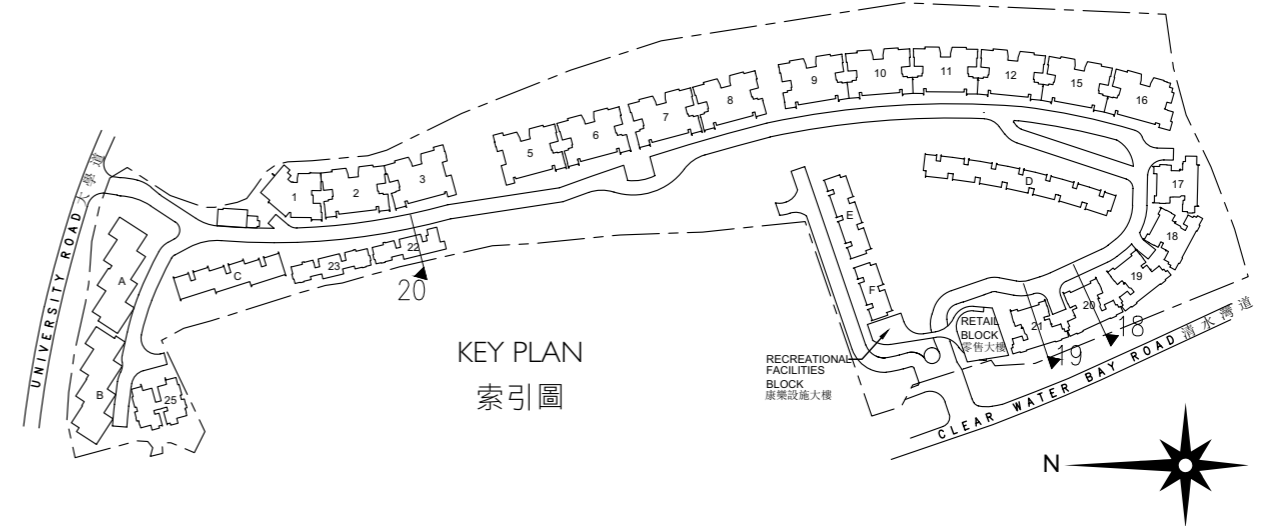
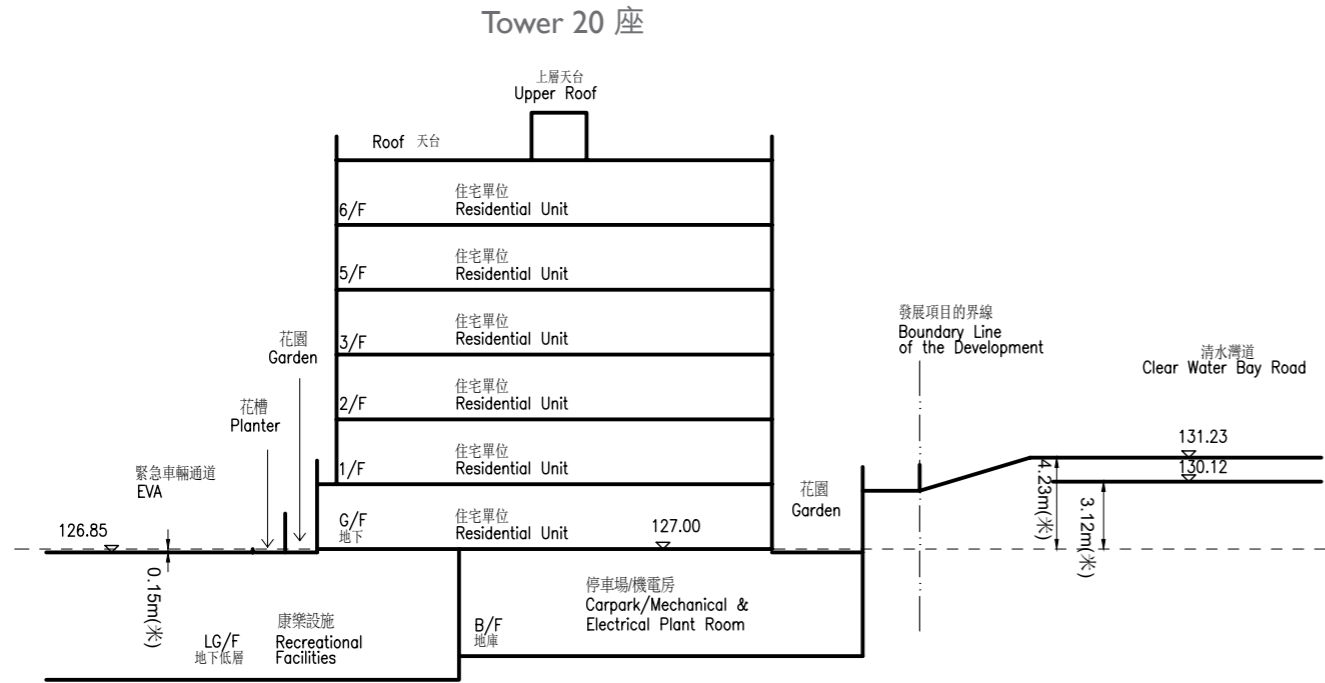

-- Dotted line denotes the lowest residential floor: 虛線為最低住宅樓層水平
EVA : Emergency Vehicular Access 緊急車輛通道

The part of Emergency Vehicular Access adjacent to the building is 126.85 metres above the Hong Kong Principal Datum.

毗連建築物的一段緊急車輛通道為香港主水平基準以上126.85米。

The part of Clearwater Bay Road adjacent to the building is 130.12 to 131.23 metres above the Hong Kong Principal Datum.

毗連建築物的一段清水灣道為香港主水平基準以上130.12至131.23米。

Cross-Section Plan 19 橫截面圖 19

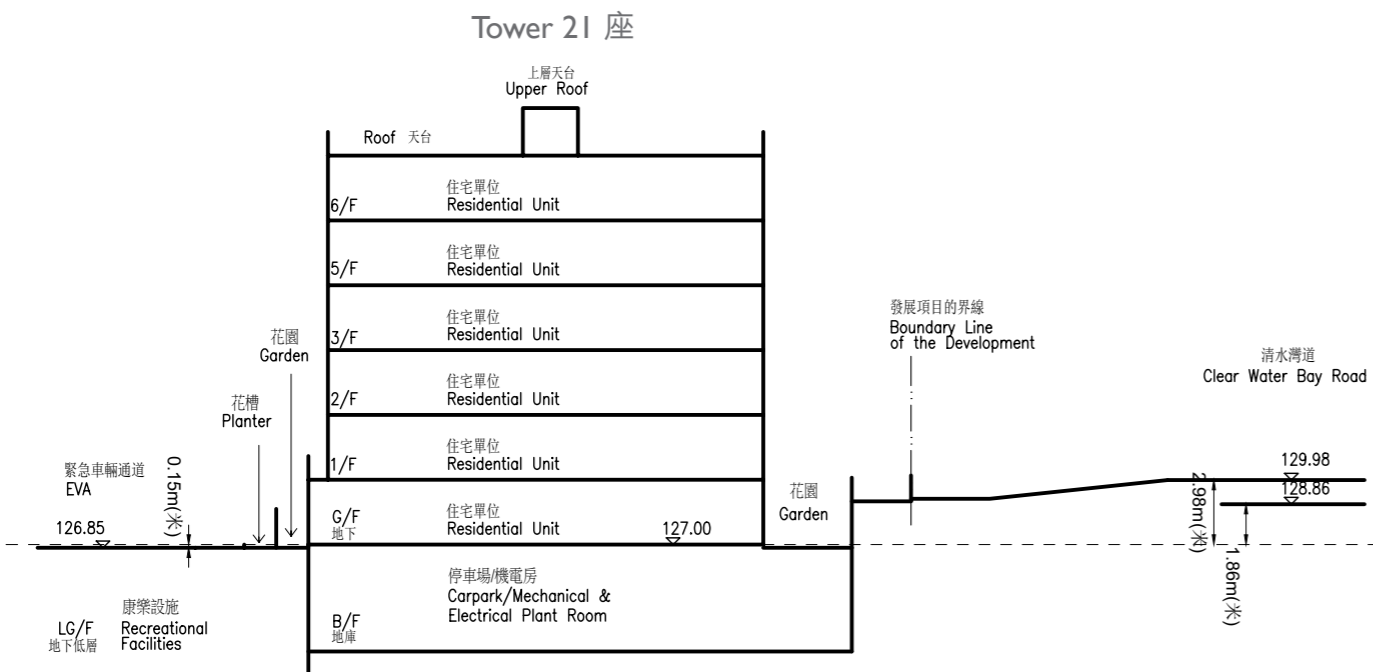

The part of Emergency Vehicular Access adjacent to the building is 126.85 metres above the Hong Kong Principal Datum.

毗連建築物的一段緊急車輛通道為香港主水平基準以上126.85米。

The part of Clearwater Bay Road adjacent to the building is 128.86 to 129.98 metres above the Hong Kong Principal Datum.

毗連建築物的一段清水灣道為香港主水平基準以上128.86至129.98米。

Cross-Section Plan 20 橫截面圖 20

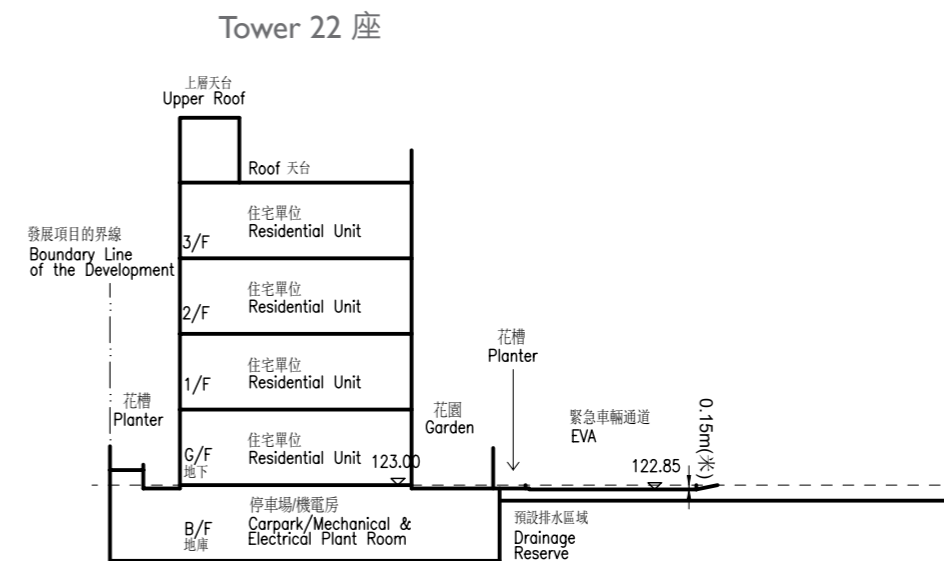

The part of Emergency Vehicular Access adjacent to the building is 122.85 metres above the Hong Kong Principal Datum.

毗連建築物的一段緊急車輛通道為香港主水平基準以上122.85米。

Cross-section plan of building in the development

發展項目中的建築物的橫截面圖

Cross-Section Plan 21 橫截面圖 21

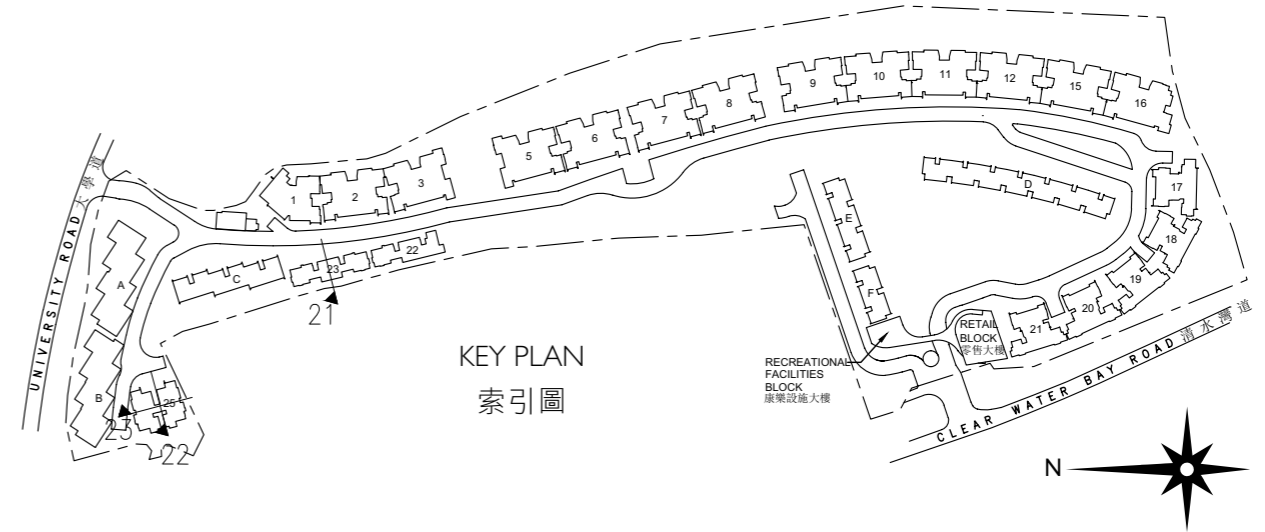
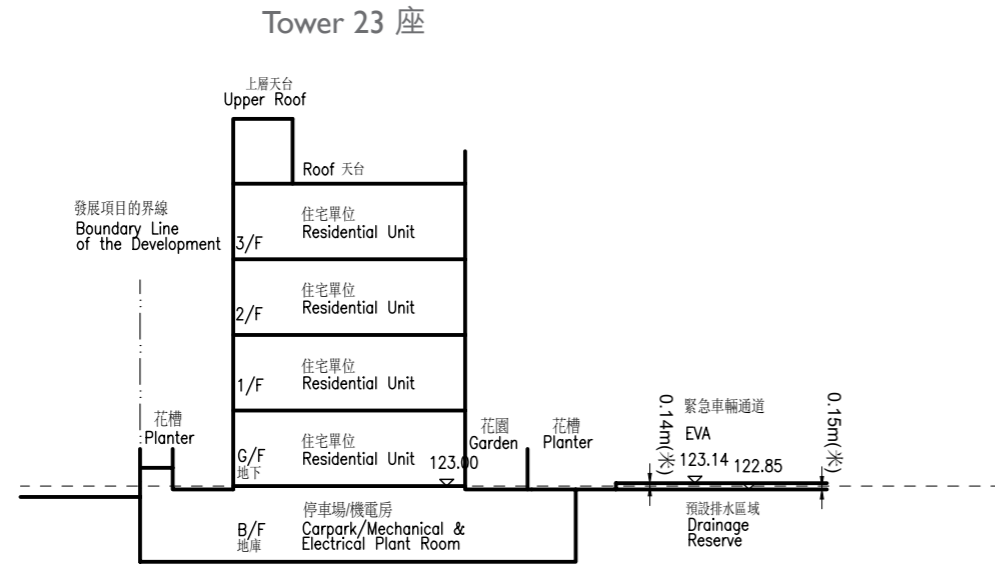

-- Dotted line denotes the lowest residential floor. 虛線為最低住宅樓層水平
EVA : Emergency Vehicular Access 緊急車輛通道

The part of Emergency Vehicular Access adjacent to the building is 122.85 to 123.14 metres above the Hong Kong Principal Datum. 毗連建築物的一段緊急車輛通道為香港主水平基準以上122.85至123.14米。

Cross-Section Plan 22 橫截面圖 22

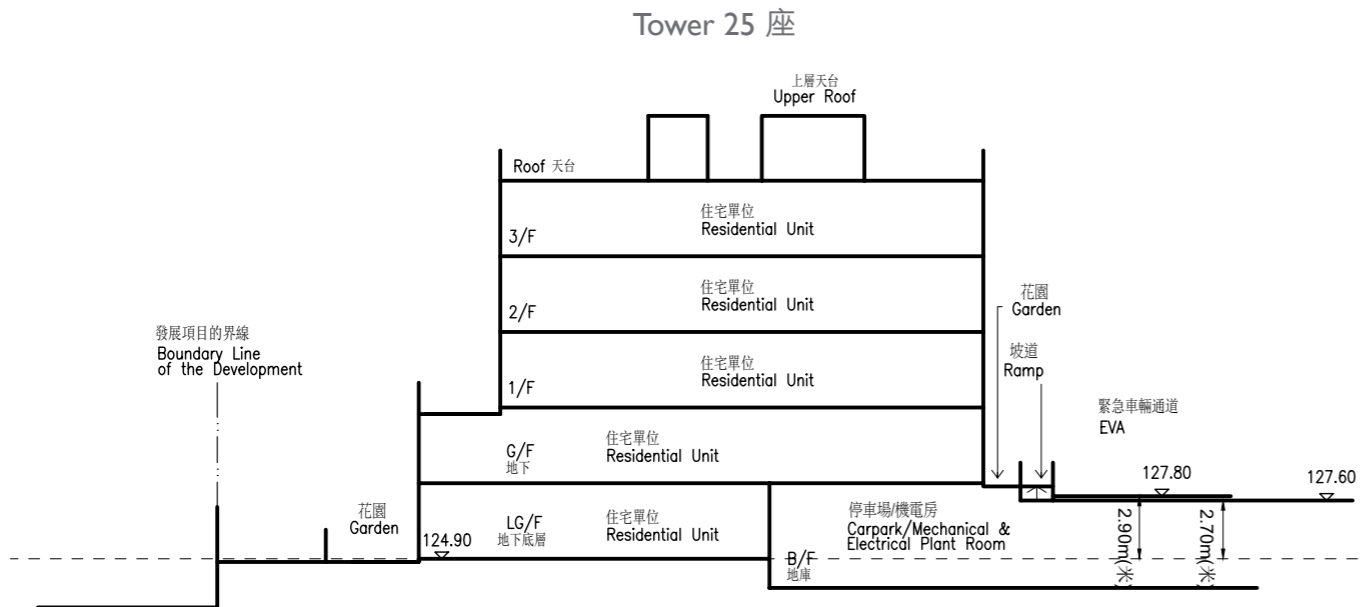

The part of Emergency Vehicular Access adjacent to the building is 127.60 to 127.80 metres above the Hong Kong Principal Datum. 毗連建築物的一段緊急車輛通道為香港主水平基準以上127.60至127.80米。

Cross-Section Plan 23 橫截面圖 23

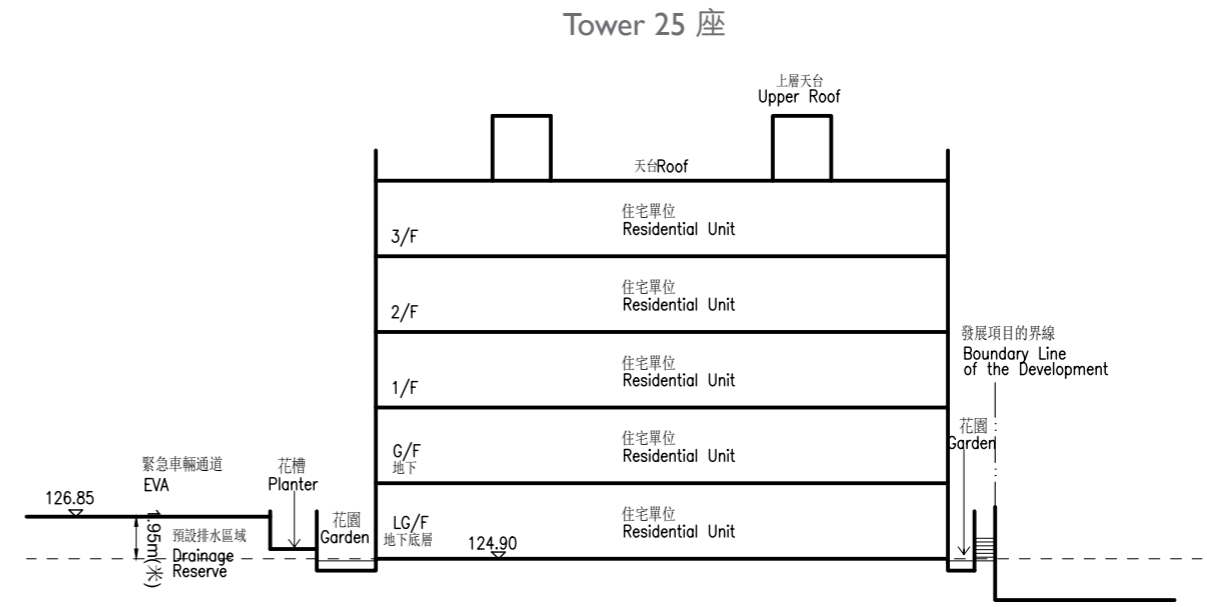

The part of Emergency Vehicular Access adjacent to the building is 126.85 metres above the Hong Kong Principal Datum. 毗連建築物的一段緊急車輛通道為香港主水平基準以上126.85米。

Elevation plan

立面圖



Elevation Plan A
立面圖A



Elevation Plan C
立面圖C

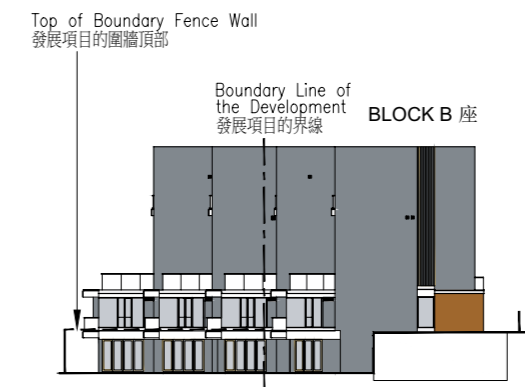

Elevation Plan B
立面圖B



Elevation Plan D
立面圖D

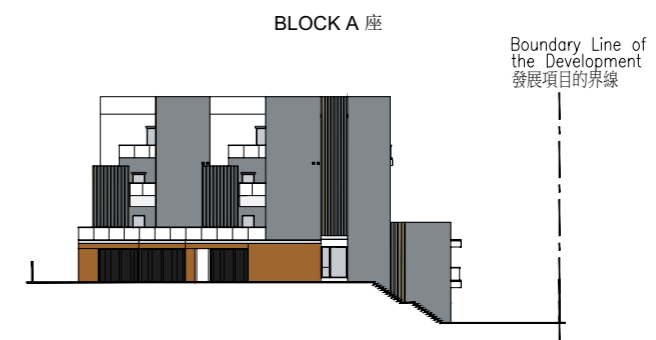

The Authorized Person for the Development has certified that the elevations shown on this plan:

1. are prepared on the basis of the approved building plans for the Development as of 2 March 2016 and 28 June 2016;
2. are in general accordance with the outward appearance of the Development.

發展項目的認可人士已證明本圖所顯示的立面：

1. 以2016年3月2日及2016年6月28日的情況為準的發展項目經批准的建築圖則為基礎擬備；
2. 大致上與該發展項目的外觀一致。

Elevation plan

立面圖

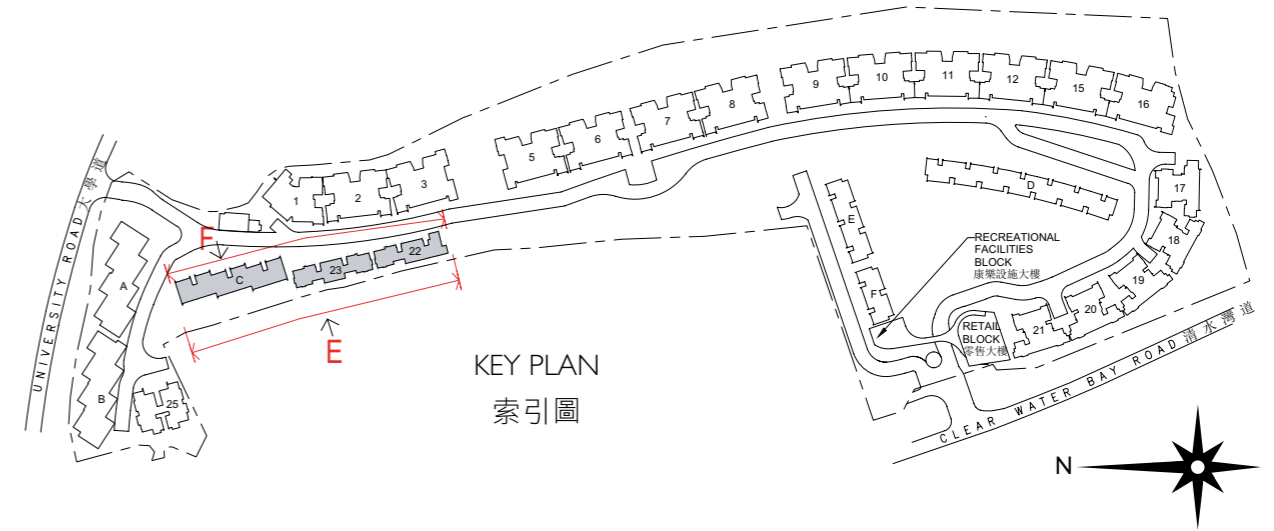

Elevation Plan E

立面圖E

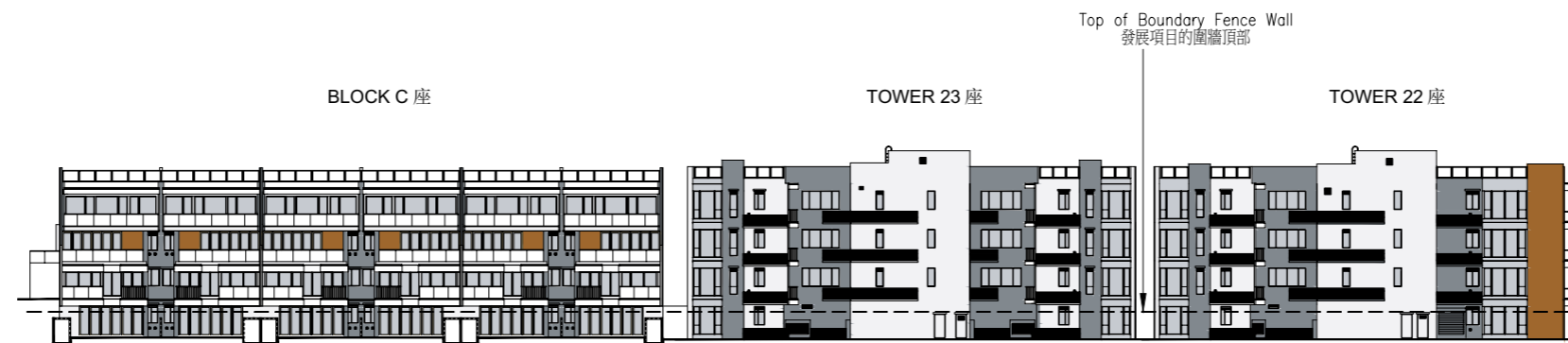

Elevation Plan F

立面圖F

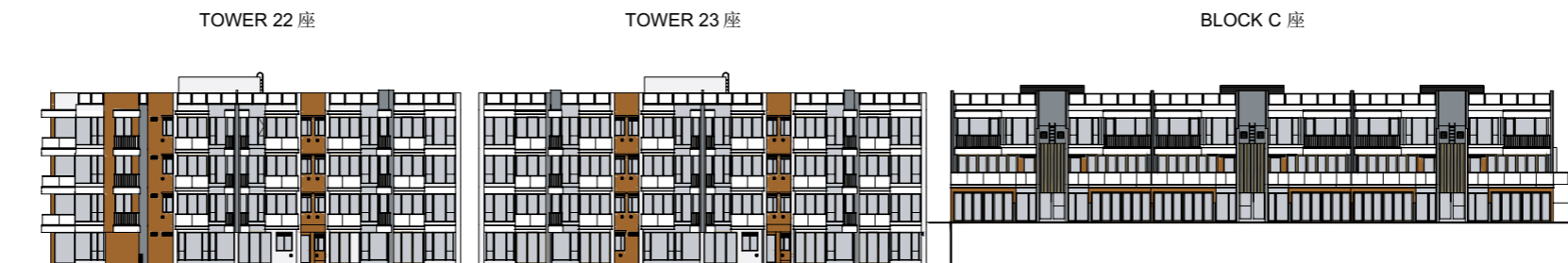

The Authorized Person for the Development has certified that the elevations shown on this plan:

1. are prepared on the basis of the approved building plans for the Development as of 2 March 2016 and 28 June 2016;
2. are in general accordance with the outward appearance of the Development.

發展項目的認可人士已證明本圖所顯示的立面：

1. 以2016年3月2日及2016年6月28日的情況為準的發展項目經批准的建築圖則為基礎擬備；
2. 大致上與該發展項目的外觀一致。

Elevation plan

立面圖

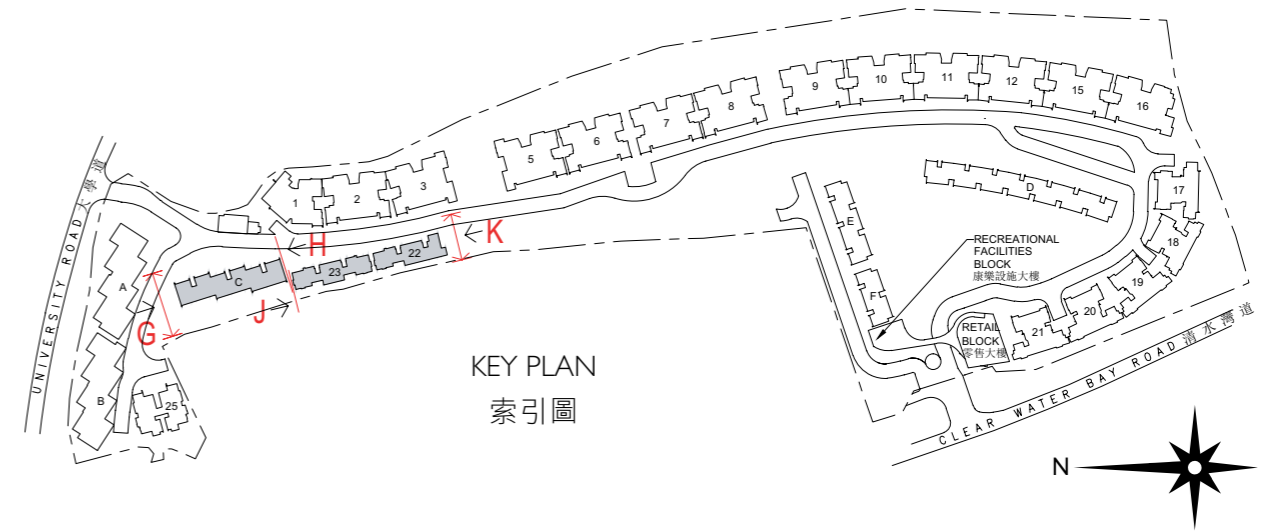

Elevation Plan G
立面圖G

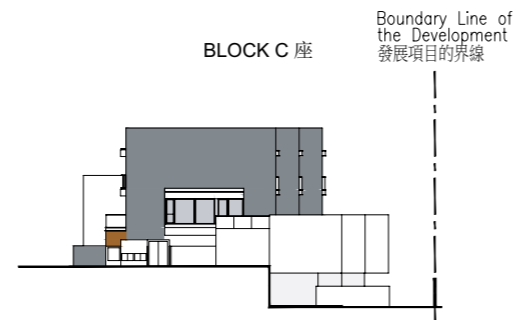

Elevation Plan H
立面圖H

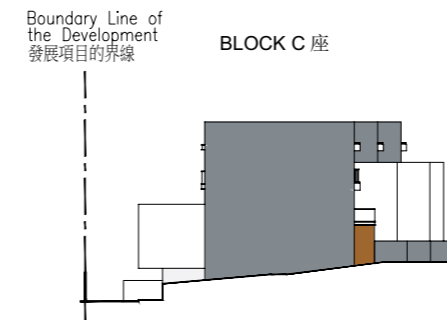

Elevation Plan J
立面圖J

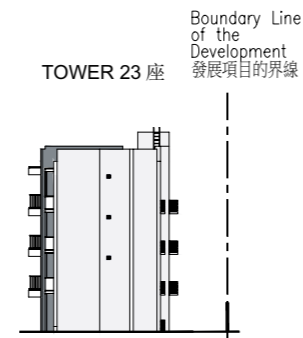

Elevation Plan K
立面圖K

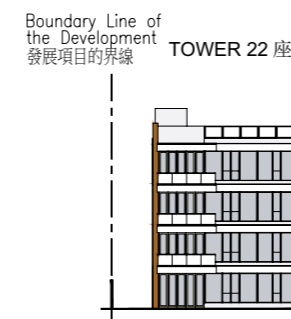

The Authorized Person for the Development has certified that the elevations shown on this plan:

1. are prepared on the basis of the approved building plans for the Development as of 2 March 2016 and 28 June 2016;
2. are in general accordance with the outward appearance of the Development.

發展項目的認可人士已證明本圖所顯示的立面：

1. 以2016年3月2日及2016年6月28日的情況為準的發展項目經批准的建築圖則為基礎擬備；
2. 大致上與該發展項目的外觀一致。

Elevation plan

立面圖

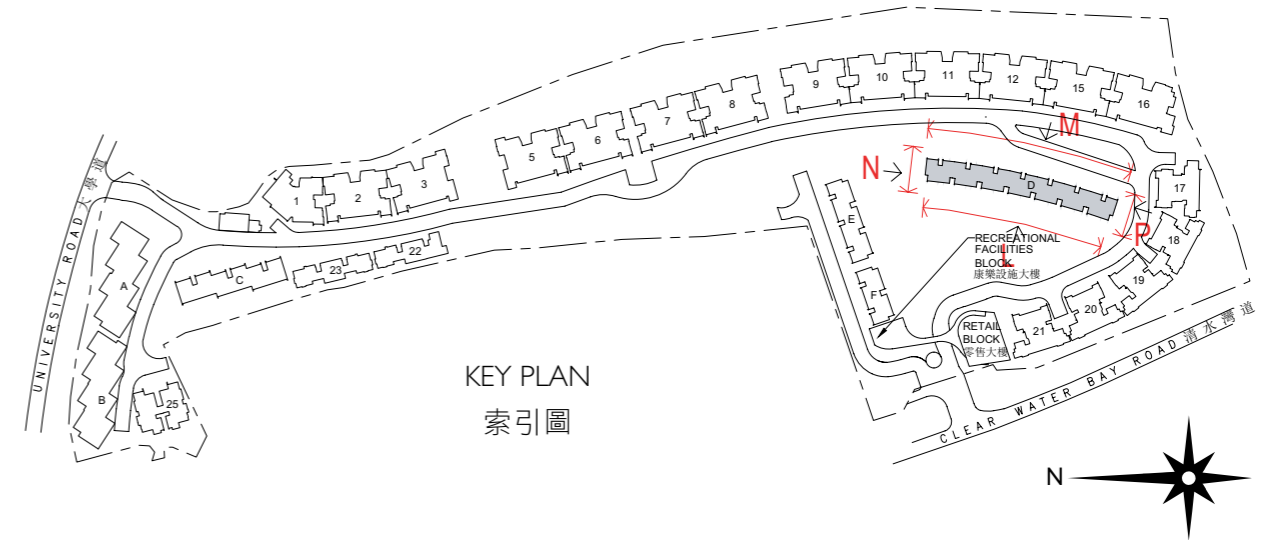

Elevation Plan L
立面圖L

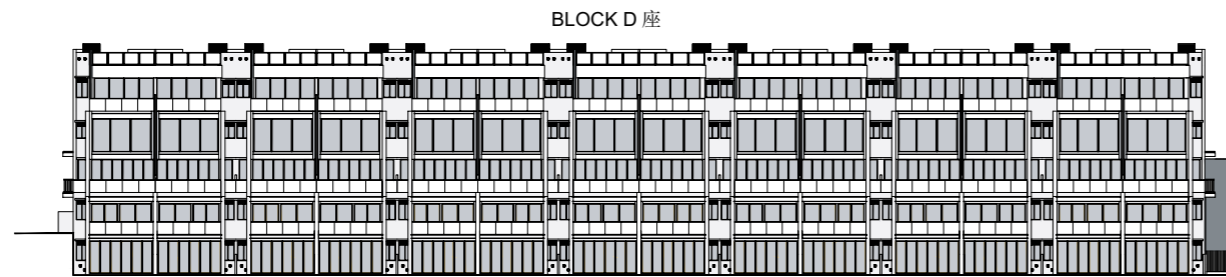

Elevation Plan N
立面圖N

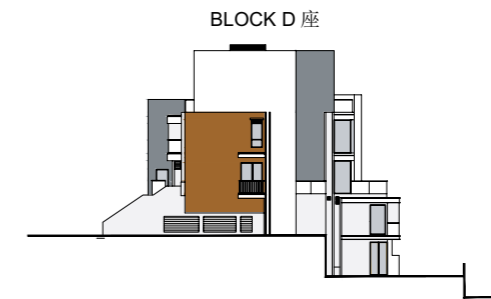

Elevation Plan M
立面圖M

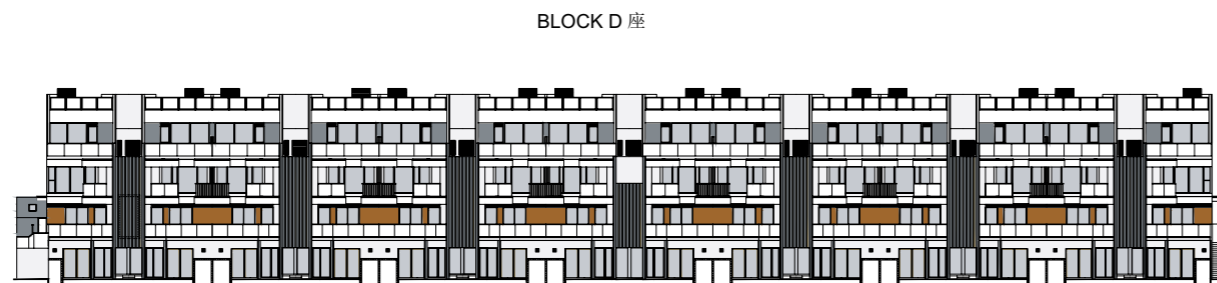

Elevation Plan P
立面圖P

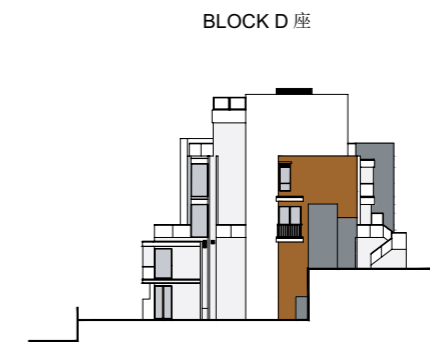

The Authorized Person for the Development has certified that the elevations shown on this plan:

1. are prepared on the basis of the approved building plans for the Development as of 2 March 2016 and 28 June 2016;
2. are in general accordance with the outward appearance of the Development.

發展項目的認可人士已證明本圖所顯示的立面：

1. 以2016年3月2日及2016年6月28日的情況為準的發展項目經批准的建築圖則為基礎擬備；
2. 大致上與該發展項目的外觀一致。

Elevation plan

立面圖

Elevation Plan Q
立面圖Q

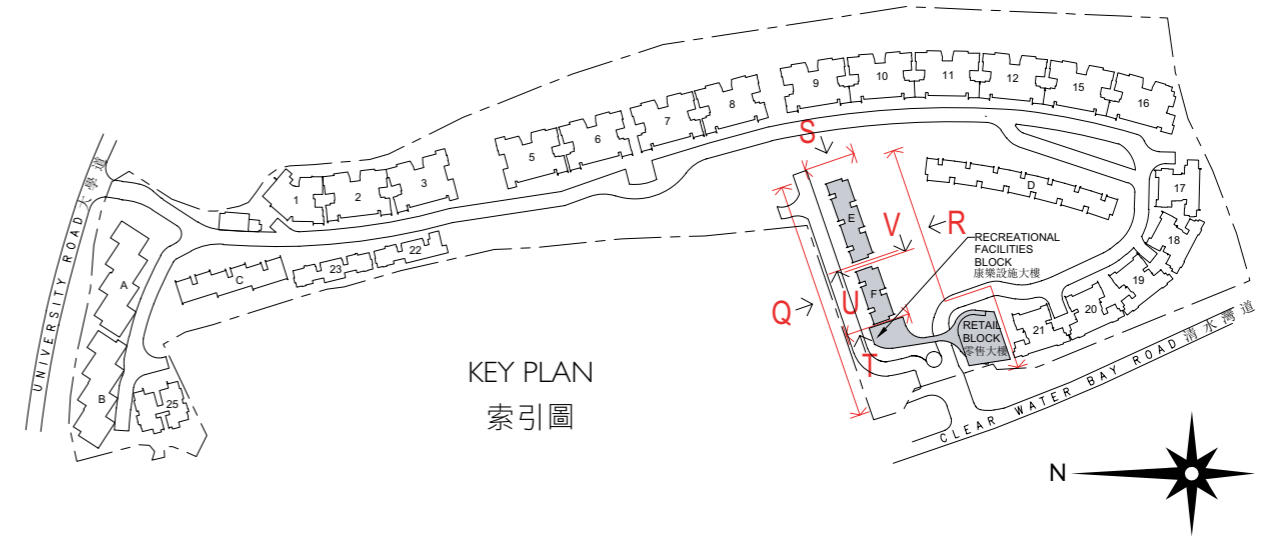
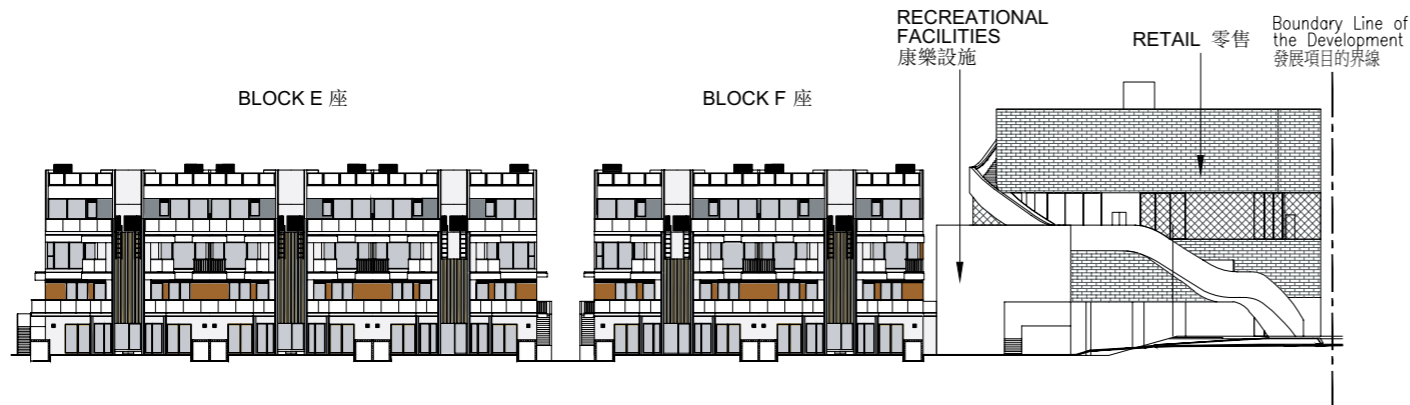

Elevation Plan R
立面圖R

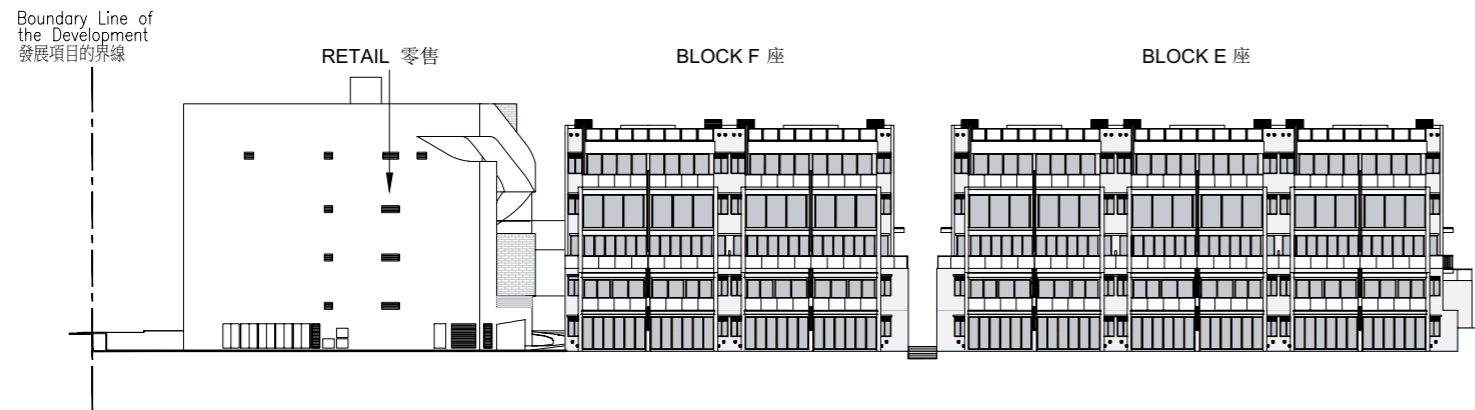

Elevation Plan S
立面圖S

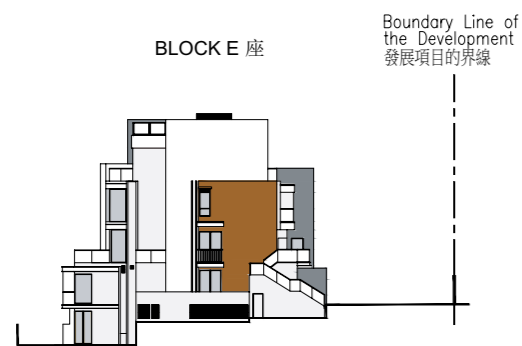

Elevation Plan T
立面圖T

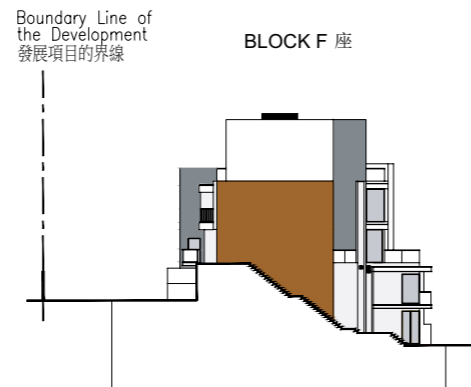

Elevation Plan U
立面圖U

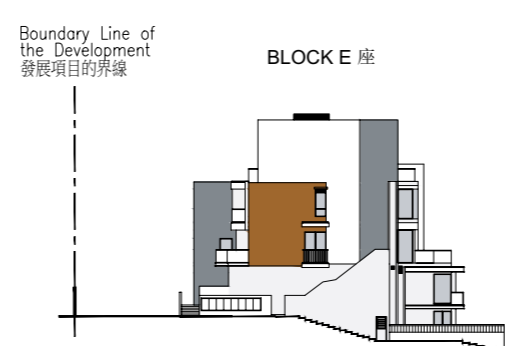

Elevation Plan V
立面圖V

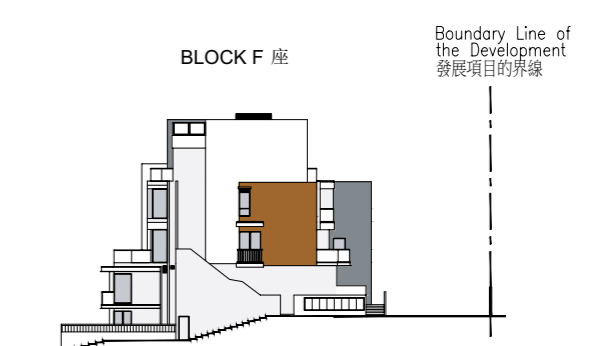

The Authorized Person for the Development has certified that the elevations shown on this plan:

1. are prepared on the basis of the approved building plans for the Development as of 2 March 2016 and 28 June 2016;
2. are in general accordance with the outward appearance of the Development.

發展項目的認可人士已證明本圖所顯示的立面：

1. 以2016年3月2日及2016年6月28日的情況為準的發展項目經批准的建築圖則為基礎擬備；
2. 大致上與該發展項目的外觀一致。

Elevation plan

立面圖

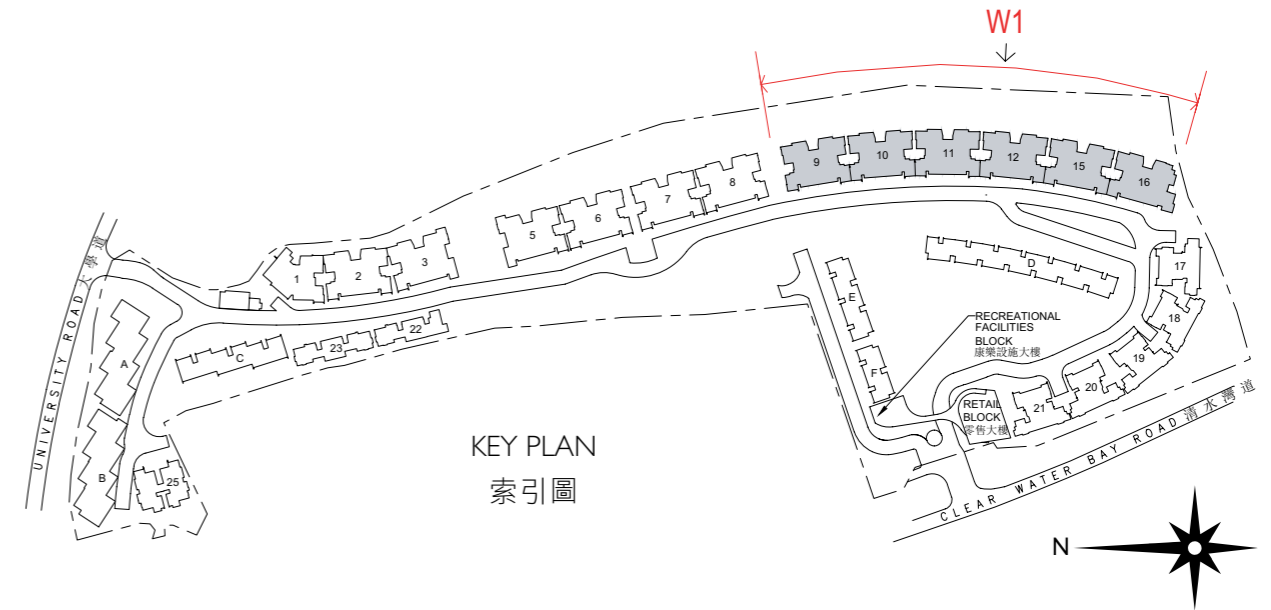

Elevation Plan W1

立面圖W1

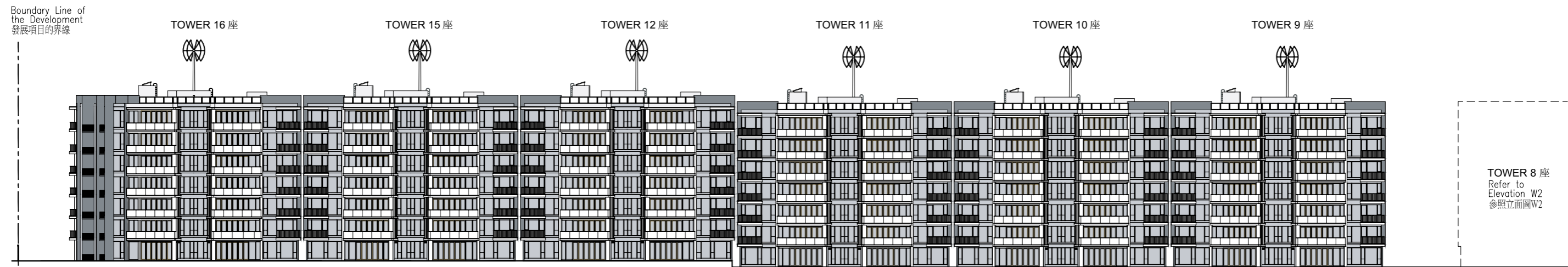

The Authorized Person for the Development has certified that the elevations shown on this plan:

1. are prepared on the basis of the approved building plans for the Development as of 2 March 2016 and 28 June 2016;
2. are in general accordance with the outward appearance of the Development.

發展項目的認可人士已證明本圖所顯示的立面：

1. 以2016年3月2日及2016年6月28日的情況為準的發展項目經批准的建築圖則為基礎擬備；
2. 大致上與該發展項目的外觀一致。

Elevation plan

立面圖

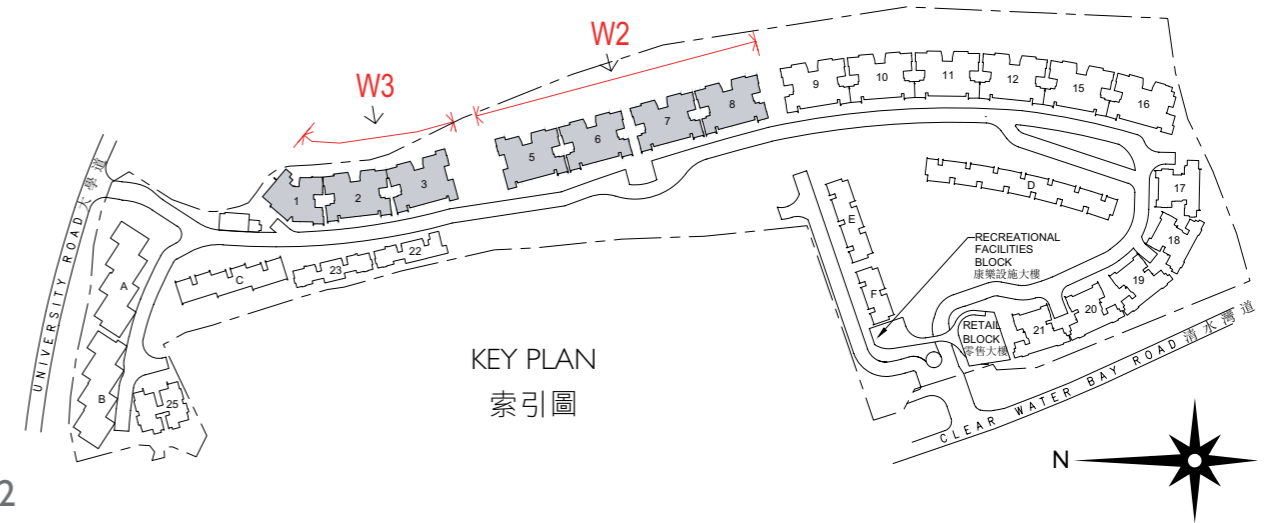

Elevation Plan W2
立面圖 W2

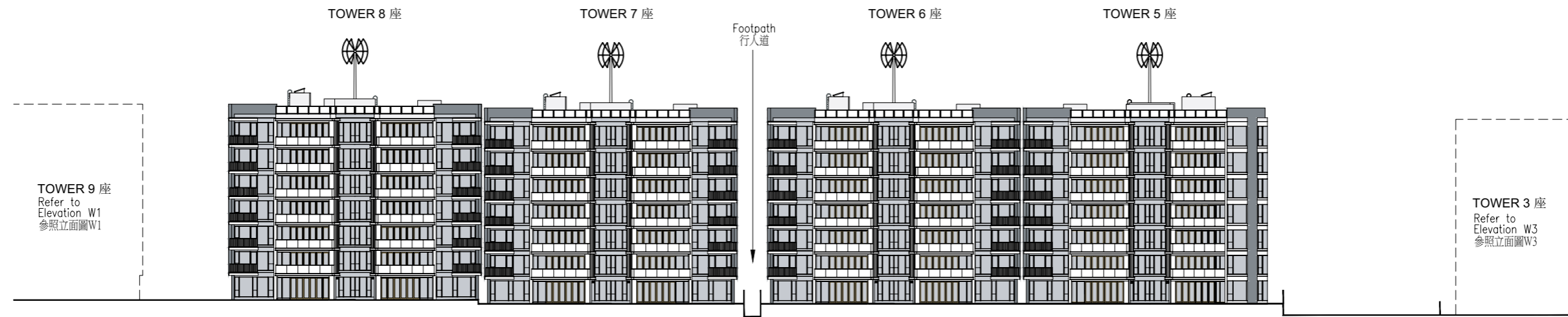

Elevation Plan W3
立面圖 W3

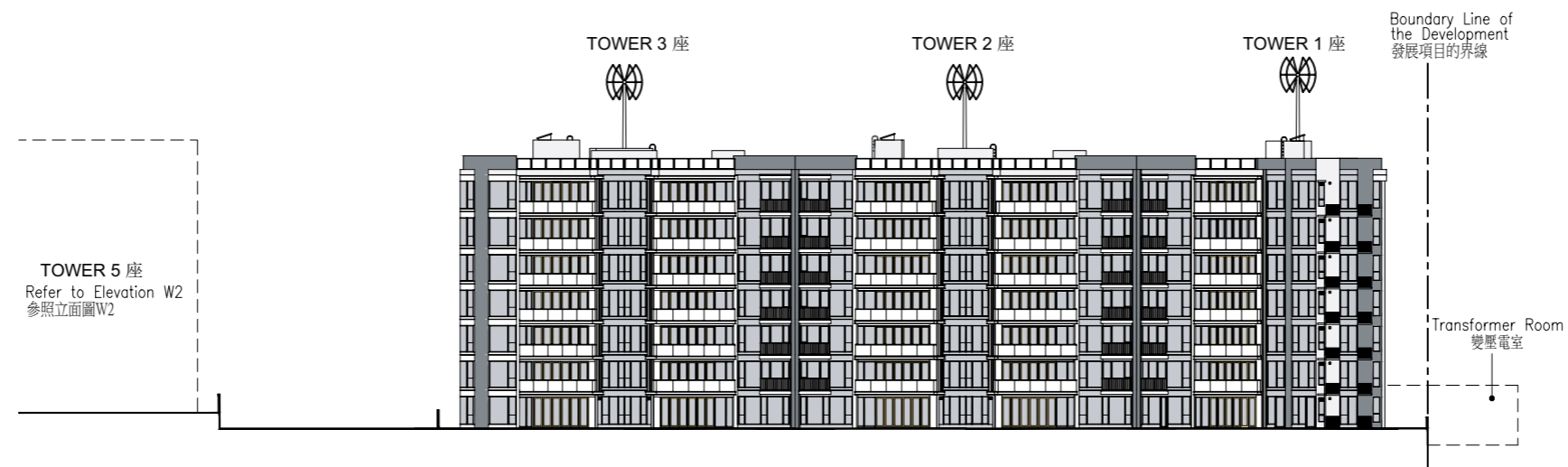

The Authorized Person for the Development has certified that the elevations shown on this plan:

1. are prepared on the basis of the approved building plans for the Development as of 2 March 2016 and 28 June 2016;
2. are in general accordance with the outward appearance of the Development.

發展項目的認可人士已證明本圖所顯示的立面：

1. 以2016年3月2日及2016年6月28日的情況為準的發展項目經批准的建築圖則為基礎擬備；
2. 大致上與該發展項目的外觀一致。

Elevation plan

立面圖

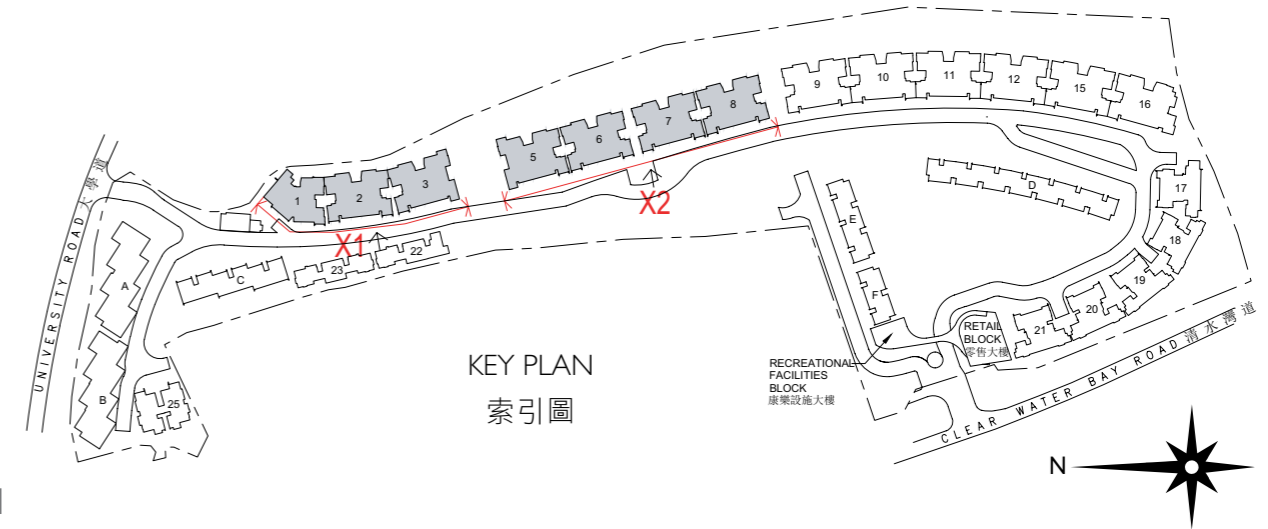

Elevation Plan X1
立面圖 X1

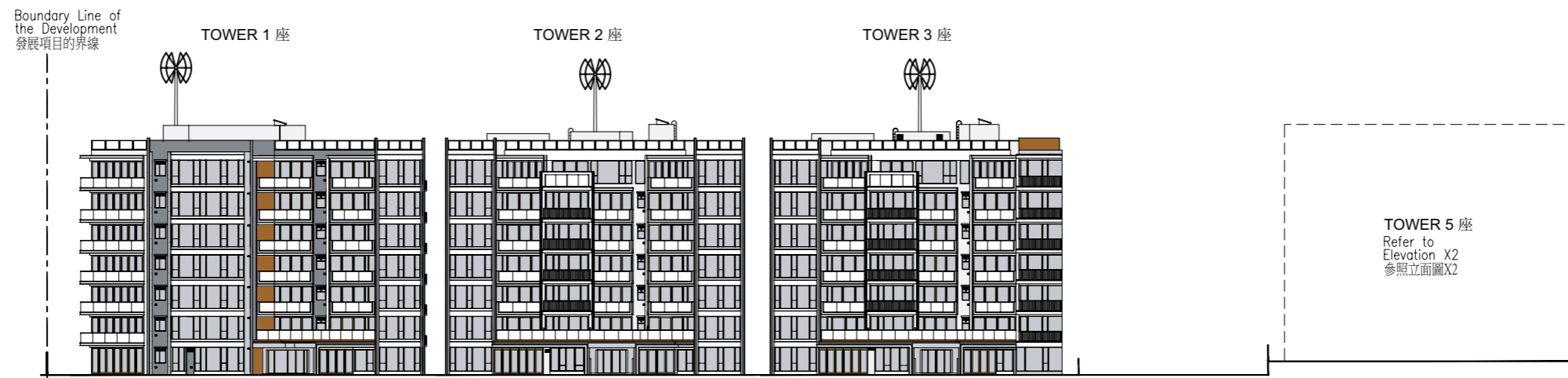

Elevation Plan X2
立面圖 X2

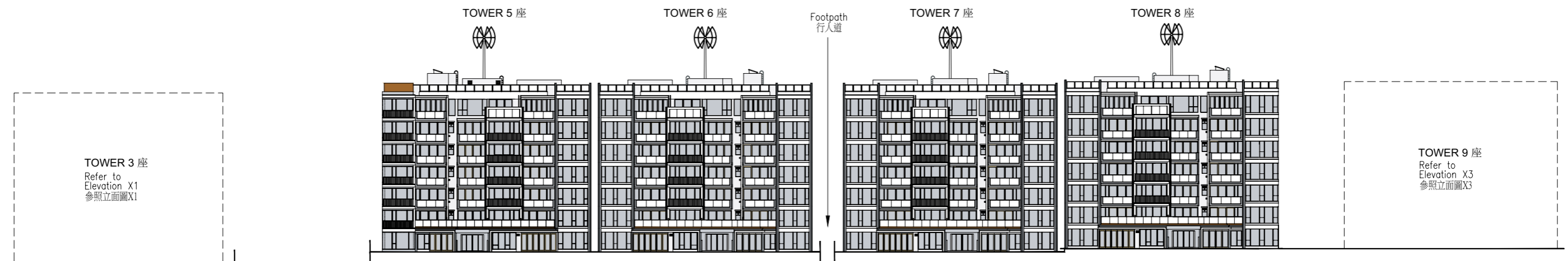

The Authorized Person for the Development has certified that the elevations shown on this plan:

1. are prepared on the basis of the approved building plans for the Development as of 2 March 2016 and 28 June 2016;
2. are in general accordance with the outward appearance of the Development.

發展項目的認可人士已證明本圖所顯示的立面：

1. 以2016年3月2日及2016年6月28日的情況為準的發展項目經批准的建築圖則為基礎擬備；
2. 大致上與該發展項目的外觀一致。

Elevation plan

立面圖

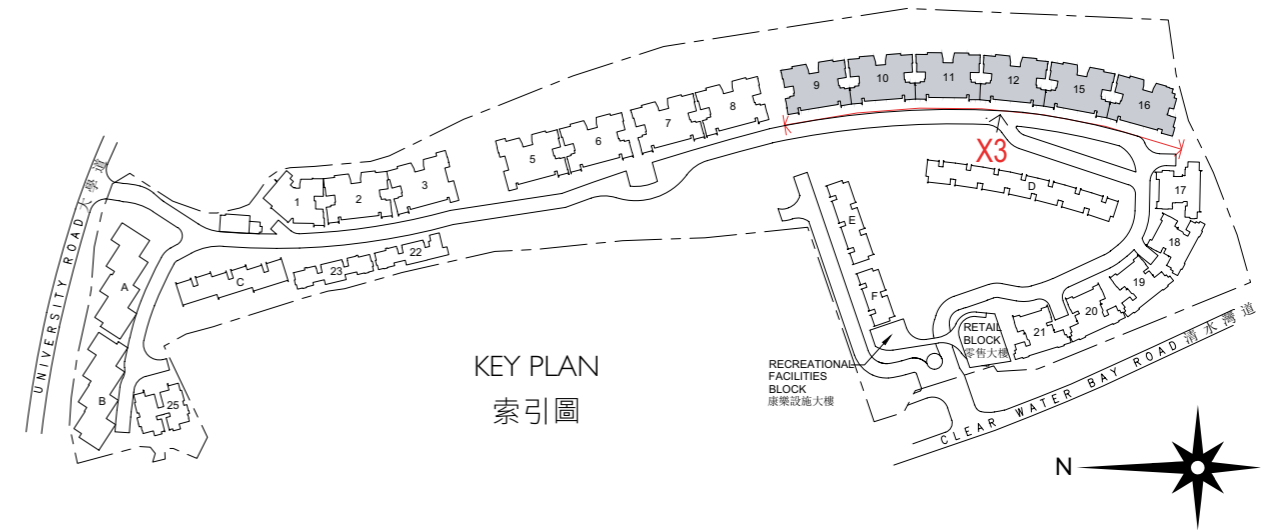

Elevation Plan X3

立面圖 X3

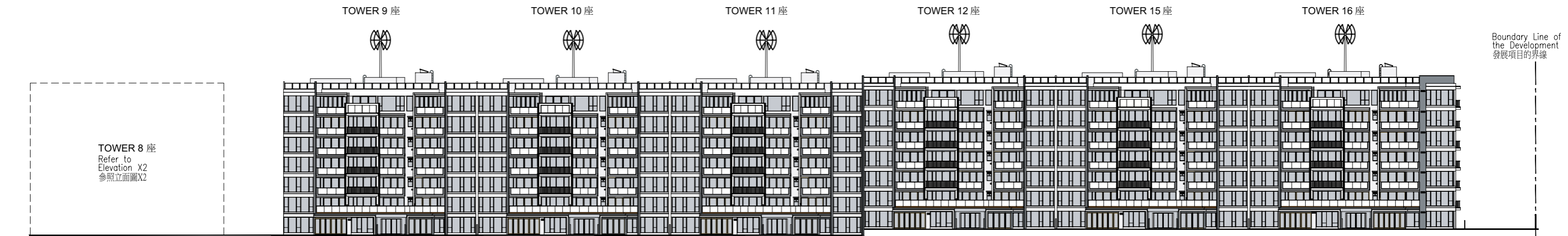

The Authorized Person for the Development has certified that the elevations shown on this plan:

1. are prepared on the basis of the approved building plans for the Development as of 2 March 2016 and 28 June 2016;
2. are in general accordance with the outward appearance of the Development.

發展項目的認可人士已證明本圖所顯示的立面：

1. 以2016年3月2日及2016年6月28日的情況為準的發展項目經批准的建築圖則為基礎擬備；
2. 大致上與該發展項目的外觀一致。

Elevation plan

立面圖

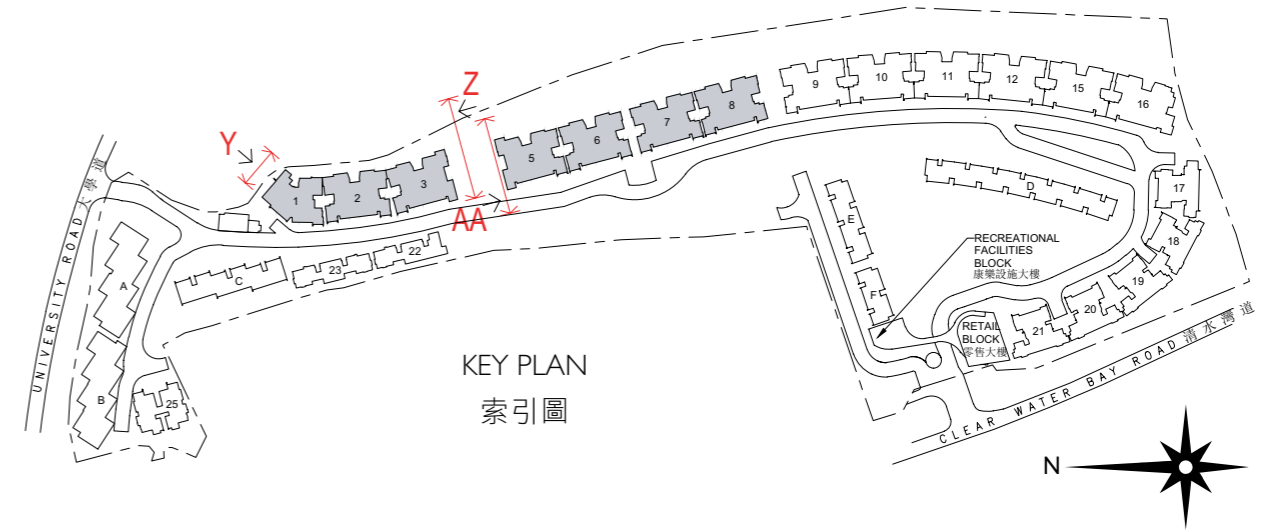

Elevation Plan Y
立面圖Y

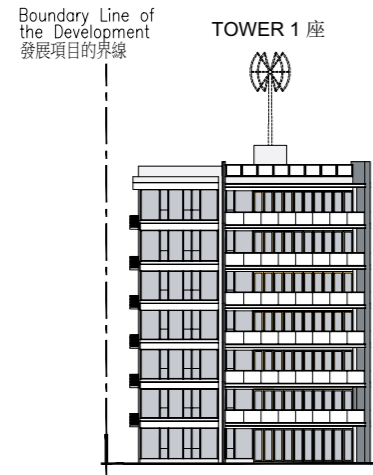

Elevation Plan Z
立面圖Z

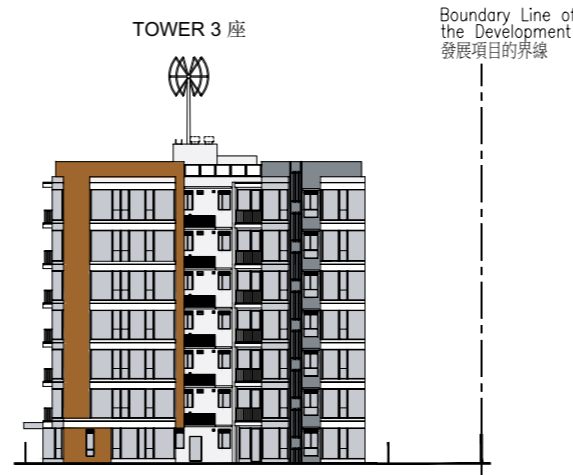

Elevation Plan AA
立面圖AA

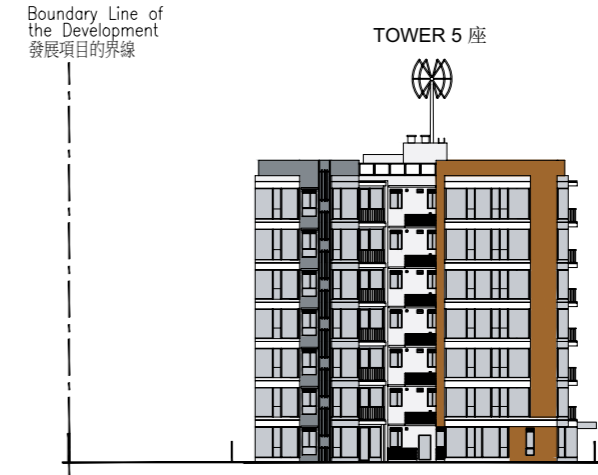

The Authorized Person for the Development has certified that the elevations shown on this plan:

1. are prepared on the basis of the approved building plans for the Development as of 2 March 2016 and 28 June 2016;
2. are in general accordance with the outward appearance of the Development.

發展項目的認可人士已證明本圖所顯示的立面：

1. 以2016年3月2日及2016年6月28日的情況為準的發展項目經批准的建築圖則為基礎擬備；
2. 大致上與該發展項目的外觀一致。

Elevation plan

立面圖

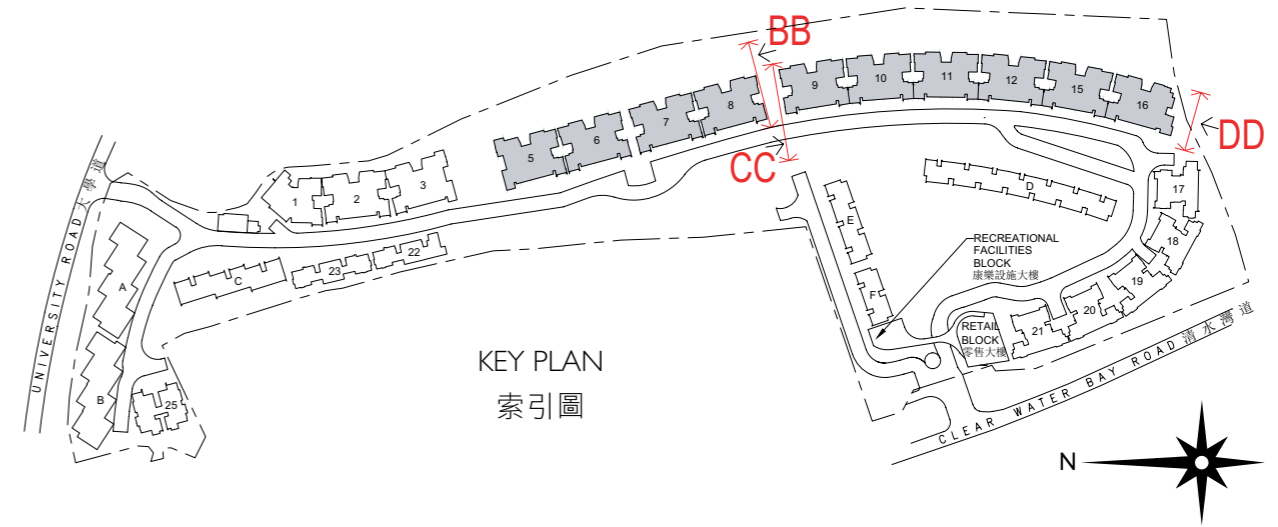

Elevation Plan BB
立面圖BB

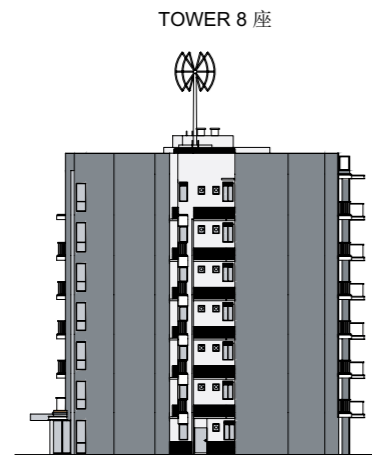

Elevation Plan CC
立面圖CC

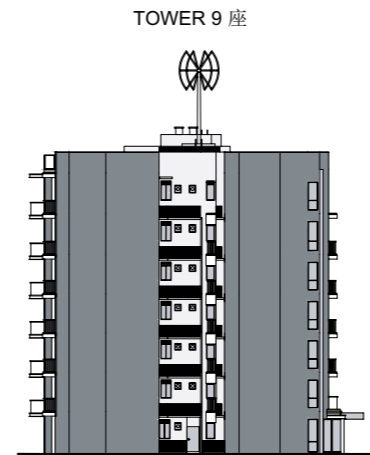

Elevation Plan DD
立面圖DD

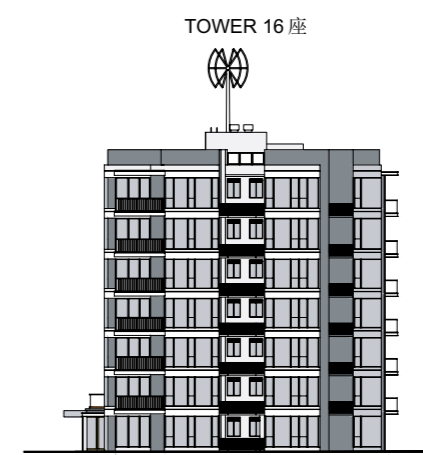

The Authorized Person for the Development has certified that the elevations shown on this plan:

1. are prepared on the basis of the approved building plans for the Development as of 2 March 2016 and 28 June 2016;
2. are in general accordance with the outward appearance of the Development.

發展項目的認可人士已證明本圖所顯示的立面：

1. 以2016年3月2日及2016年6月28日的情況為準的發展項目經批准的建築圖則為基礎擬備；
2. 大致上與該發展項目的外觀一致。

Elevation plan

立面圖

Elevation Plan GG
立面圖GG

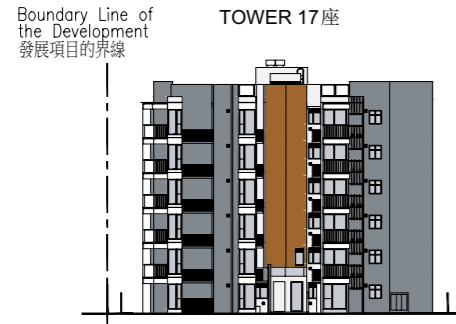

Elevation Plan HH
立面圖HH

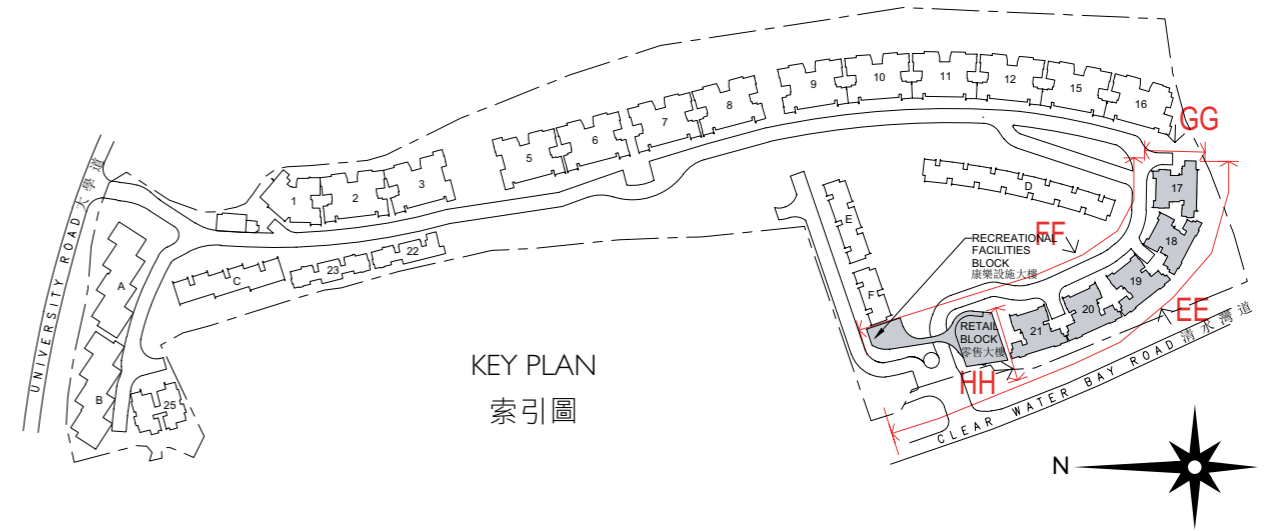
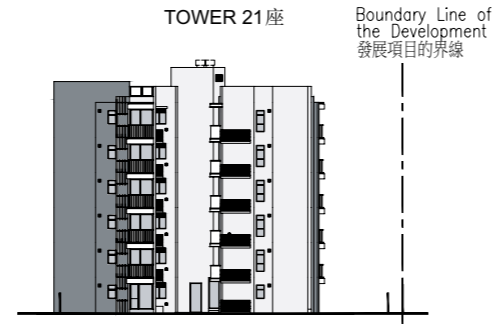

Elevation Plan EE
立面圖EE

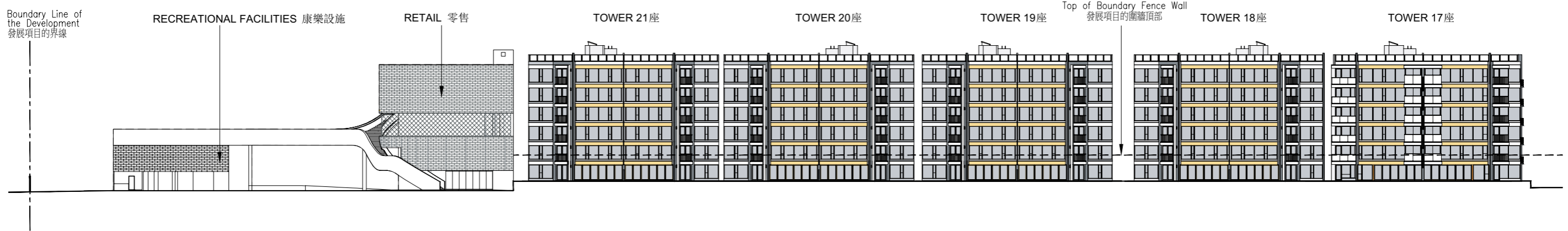

Elevation Plan FF
立面圖FF

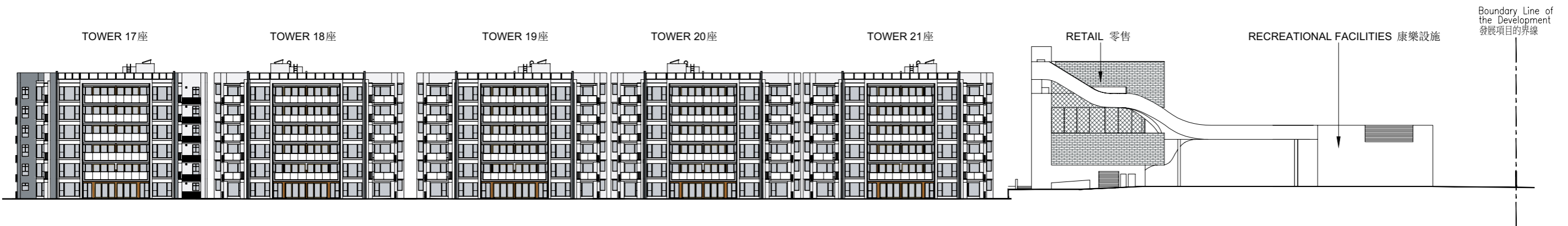

The Authorized Person for the Development has certified that the elevations shown on this plan:

1. are prepared on the basis of the approved building plans for the Development as of 2 March 2016 and 28 June 2016;
2. are in general accordance with the outward appearance of the Development.

發展項目的認可人士已證明本圖所顯示的立面：

1. 以2016年3月2日及2016年6月28日的情況為準的發展項目經批准的建築圖則為基礎擬備；
2. 大致上與該發展項目的外觀一致。

Elevation plan

立面圖

Elevation Plan JJ
立面圖JJ

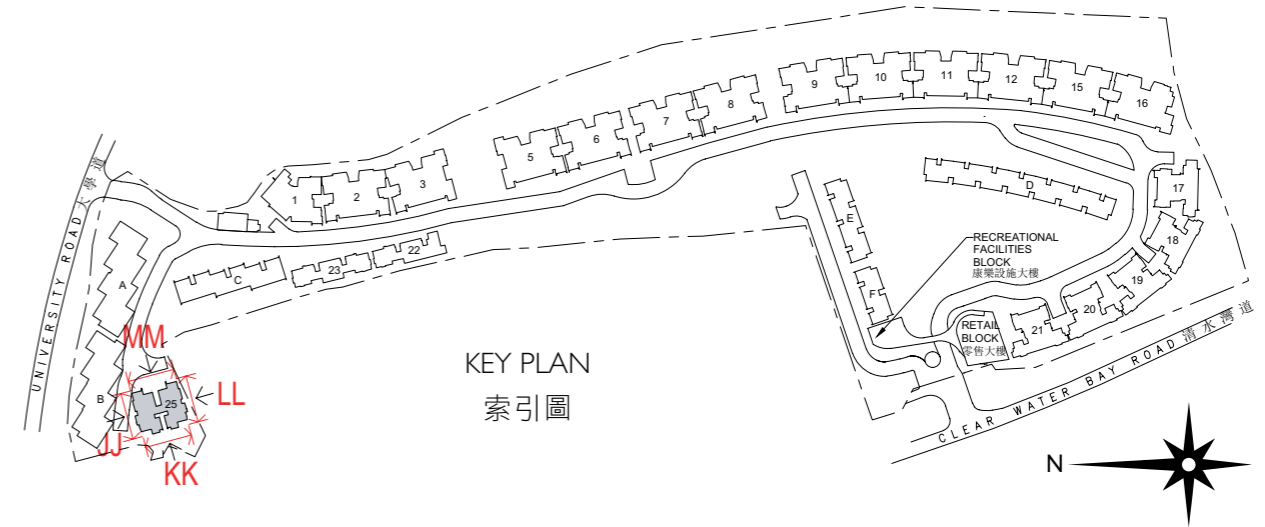
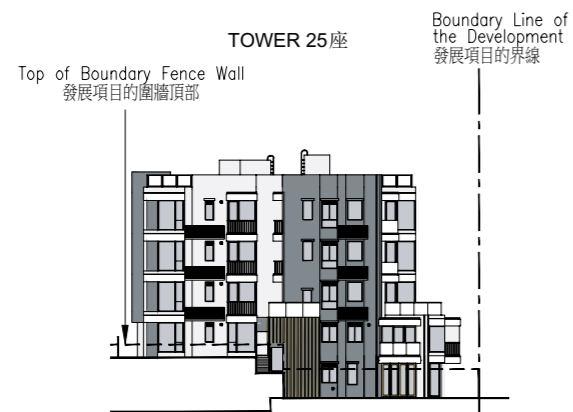

Elevation Plan KK
立面圖KK

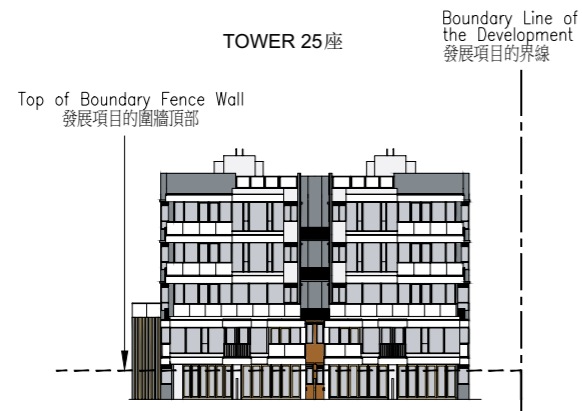

Elevation Plan LL
立面圖LL

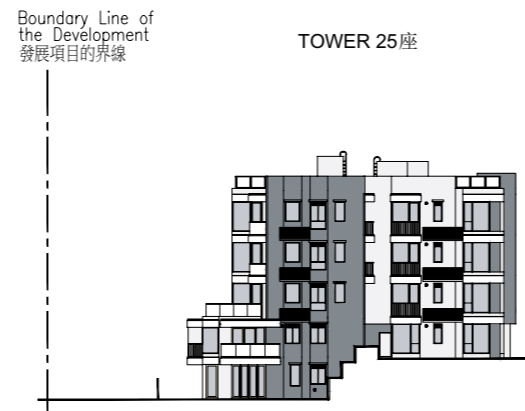

Elevation Plan MM
立面圖MM

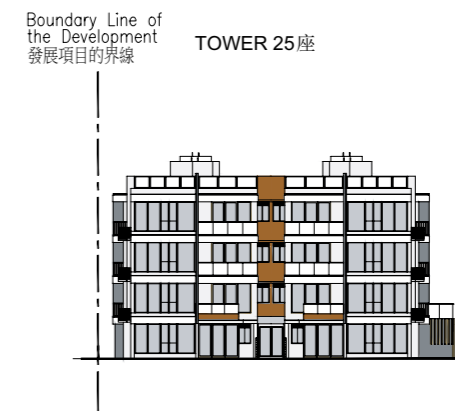

The Authorized Person for the Development has certified that the elevations shown on this plan:

1. are prepared on the basis of the approved building plans for the Development as of 2 March 2016 and 28 June 2016;
2. are in general accordance with the outward appearance of the Development.

發展項目的認可人士已證明本圖所顯示的立面：

1. 以2016年3月2日及2016年6月28日的情況為準的發展項目經批准的建築圖則為基礎擬備；
2. 大致上與該發展項目的外觀一致。

Information on common facilities in the development

發展項目中的公用設施的資料

Common Facilities 公用設施		Area 面積		Total Area 總數	
		sq.m. 平方米	sq.ft. 平方呎	sq.m. 平方米	sq.ft. 平方呎
Residents' clubhouse (including any recreational facilities for residents' use) 住客會所(包括供住客使用的任何康樂設施)	Covered 有上蓋	3,436	36,989	6,277	67,565
	Uncovered 沒有上蓋	2,841	30,576		
Communal garden or play area for residents' use on the roof, or on any floor between the roof and the lowest residential floor, of a building in the Development (whether known as a communal sky garden or otherwise) 位於發展項目中的建築物的天台或在天台和最低一層住宅樓層之間的任何一層的、供住客使用的公用花園或遊樂地方(不論是稱為公用空中花園或有其他名稱)	Covered 有上蓋	-	-	-	-
	Uncovered 沒有上蓋	-	-		
Communal garden or play area for residents' use below the lowest residential floor of a building in the Development (whether known as a covered and landscaped play area or otherwise) 位於發展項目中的建築物的最低一層住宅樓層以下的、供住客使用的公用花園或遊樂地方(不論是稱為有蓋及園景的遊樂場或有其他名稱)	Covered 有上蓋	-	-	25,744	277,108
	Uncovered 沒有上蓋	25,744	277,108		

Remarks:

1. Areas in square metres as specified above are based on the latest approved building plans.
2. Areas in square feet are converted from areas in square metres at a rate of 1 square metre to 10.764 square feet and rounded off to the nearest integer.

備註：

1. 上述所列以平方米顯示之面積乃依據最新的經批准的建築圖則。
2. 以平方呎顯示的面積由以平方米顯示之面積以1平方米=10.764平方呎換算，並以四捨五入至整數。

閱覽圖則及公契

1. The address of the website at which a copy of the outline zoning plan relating to the Development is available is: www.ozp.tpb.gov.hk
 2. (a) A copy of the latest draft of every deed of mutual covenant in respect of the specified residential properties as at the date on which the specified residential properties are offered to be sold is available for inspection at the place at which the specified residential properties are offered to be sold.
(b) The inspection is free of charge.
1. 關於本發展項目的分區計劃大綱圖的文本供閱覽的互聯網網站的網址為：
www.ozp.tpb.gov.hk
 2. (a) 指明住宅物業的每公契在將指明住宅物業提供出售的日期的最新擬稿的本文存放在指明住宅物業的售樓處，以供閱覽。
(b) 無須為閱覽付費。

Fittings, finishes and appliances

裝置、裝修物料及設備

I. Exterior finishes	
Item	Description
(a) External wall	- Finished with ceramic tiles, artificial granite tiles, aluminium curtain wall, aluminium cladding, aluminium louvre and grille, natural stone, metal balustrade, glass balustrade and paint.
(b) Window	- Fluorocarbon coated aluminium window frames fitted with single pane glass.
(c) Bay window	- Not provided.
(d) Planter	- Not provided.
(e) Verandah or balcony	- Balcony is provided with fluorocarbon coated aluminium balustrade with single pane glass and artificial stone capping. Wall is finished with aluminium curtain wall, aluminium cladding, artificial granite tiles and ceramic tiles. Floor is finished with ceramic tiles. Ceiling is finished with aluminum panel and paint, except ceiling of balconies in the following residential properties, which are finished with acoustic aluminum panels: Flat A and B, 6/F, Tower 17 Flat A and B, 2/F to 3/F, Tower 25 - Balconies are covered except those of Residential Unit P1, P2, P3 and P5 of Block A and B are uncovered. - There is no verandah.
(f) Drying facilities for clothing	- Not provided.

1. 外部裝修物料	
細項	描述
(a) 外牆	- 鋪砌瓷磚、人造花崗石磚、鋁玻璃幕牆、鋁板、鋁百葉及格柵、天然石、金屬欄杆、玻璃欄杆及油漆。
(b) 窗	- 採用氟化碳噴鋁窗框鑲單片玻璃。
(c) 窗台	- 沒有提供。
(d) 花槽	- 沒有提供。
(e) 陽台或露台	- 露台裝設氟化碳噴鋁欄杆鑲單片玻璃及人造石材扶手。牆身鋪鋁玻璃幕牆、鋁蓋板、人造花崗石磚及瓷磚。地台鋪砌瓷磚。天花板鋪鋁板及油漆，除以下住宅物業露台天花鋪設隔聲鋁板： 17座：6樓A單位及B單位 25座：2樓至3樓A單位及B單位 - 所有露台有蓋，除A座及B座P1、P2、P3及P5住宅單位的露台沒有蓋。 - 沒有陽台。
(f) 乾衣設施	- 沒有提供。

Remarks:

- In the description of residential property in a residential block, the prefix "G" means Garden Duplex unit and the numbering means the numbering of Garden Duplex unit of Block A, B, C, D, E or F (as the case may be). e.g. "G1" refers to Garden Duplex 1 of Block A, B, C, D, E or F (as the case may be).
- In the description of residential property in a residential block, the prefix "P" means Penthouse Triplex unit and the numbering means the numbering of Penthouse Triplex unit of Block A, B, D, E or F (as the case may be). e.g. "P1" refers to Penthouse Triplex 1 of Block A, B, D, E or F (as the case may be).
- In the description of residential property in a residential block, the prefix "P" means Penthouse Duplex unit and the numbering means the numbering of Penthouse Duplex unit of Block C. e.g. "P1" refers to Penthouse Duplex 1 of Block C.

備註:

- 住宅大樓的住宅物業的描述中，字首「G」指花園複式單位，而編號指A、B、C、D、E或F座(視情況而定)的花園複式單位的編號。例如「G1」指A、B、C、D、E或F座(視情況而定)的花園複式1號單位。
- 住宅大樓中住宅物業的描述中，字首「P」指頂層三複式單位，而編號指A、B、D、E或F座(視情況而定)的頂層三複式單位的編號。例如「P1」指A、B、D、E或F座(視情況而定)的頂層三複式1號單位。
- 住宅大樓中住宅物業的描述中，字首「P」指頂層複式單位，而編號指C座的頂層複式單位的編號。例如「P1」指C座的頂層複式1號單位。

Fittings, finishes and appliances

裝置、裝修物料及設備

2. Interior finishes	
Item	Description
(a) Lobby	<p>Lift Lobby at G/F of Tower 1 to 25 (Tower 4, 13, 14 and 24 omitted)</p> <ul style="list-style-type: none"> - Wall is finished with plastic laminate, glass panel, natural stone, stainless steel and metal panel. Floor is finished with ceramic tiles. Gypsum board false ceiling finished with emulsion paint. <p>Lift Lobby and Entrance Hall (Private Lift Lobby) on the floors other than G/F of Tower 1 to 25 (4/F omitted, Tower 4, 13, 14 and 24 omitted)</p> <ul style="list-style-type: none"> - Wall is finished with plastic laminate, stainless steel and glass panel. Floor is finished with ceramic tiles. Gypsum board false ceiling finished with emulsion paint. <p>Lift Lobby at G/F of Block A to F</p> <ul style="list-style-type: none"> - Wall is finished with plastic laminate, glass panel, stainless steel and metal panel. Floor is finished with ceramic tiles. Gypsum board false ceiling finished with emulsion paint. <p>Lift Lobby at LG/F of Block A to F; 1/F and 2/F of Block A, B, D, E and F; 1/F of Block C</p> <ul style="list-style-type: none"> - Wall is finished with glass panel and ceramic tiles. Floor is finished with ceramic tiles. Gypsum board false ceiling finished with emulsion paint.
(b) Internal wall and ceiling	<ul style="list-style-type: none"> - Walls of living room, dining room and bedroom are finished with emulsion paint. - Ceilings of living room, dining room and bedroom, partly provided with gypsum board false ceiling, are finished with emulsion paint.
(c) Internal floor	<ul style="list-style-type: none"> - Living room, dining room and bedroom are finished with engineered timber flooring and painted timber skirting. - Floor border along doors leading to balconies, utility platforms, gardens, flat roofs and conservatories, is partially finished with natural stone.
(d) Bathroom	<ul style="list-style-type: none"> - Wall (except areas above false ceiling level and areas covered by vanity cabinet and wall hung mirror cabinet) is finished with ceramic tiles, and some areas finished with mirror and plastic laminate. - Floor (except those areas under bath tub and areas covered by vanity cabinet) is finished with natural stone. - Painted gypsum board false ceiling is provided. - Wall finishes run up to the false ceiling.
(e) Kitchen	<ul style="list-style-type: none"> - Wall (except areas above false ceiling level and areas covered by kitchen cabinets) is finished with glass and plastic laminate. - Floor (except areas covered by kitchen cabinets) is finished with ceramic tiles. - Painted gypsum board and aluminium false ceilings are provided. - Cooking bench top finished with artificial stone. - Wall finishes run up to the false ceiling.

2. 室內裝修物料	
細項	描述
(a) 大堂	<p>1至25座地下升降機大堂(不設4、13、14及24座)</p> <ul style="list-style-type: none"> - 牆身鋪膠板、玻璃飾面、天然石、不銹鋼及金屬板飾面。地台鋪砌瓷磚。設有石膏板假天花髹上乳膠漆。 <p>1至25座升降機大堂及入口大堂(私人升降機大堂)除設於地下外的各樓層(不設4樓，不設4、13、14及24座)</p> <ul style="list-style-type: none"> - 牆身鋪膠板、不銹鋼及玻璃飾面。地台鋪砌瓷磚。設有石膏板假天花髹上乳膠漆。 <p>A至F座地下升降機大堂</p> <ul style="list-style-type: none"> - 牆身鋪膠板、玻璃飾面、不銹鋼及金屬板飾面。地台鋪砌瓷磚。設有石膏板假天花髹上乳膠漆。 <p>A至F座地下低層；A、B、D、E及F座1樓及2樓；C座1樓之升降機大堂</p> <ul style="list-style-type: none"> - 牆身鋪玻璃飾面及瓷磚飾面。地台鋪砌瓷磚。設有石膏板假天花髹上乳膠漆。
(b) 內牆及天花板	<ul style="list-style-type: none"> - 客廳、飯廳及睡房的牆身髹上乳膠漆。 - 客廳、飯廳及睡房的天花板，部分裝設石膏板假天花，均髹上乳膠漆。
(c) 內部地板	<ul style="list-style-type: none"> - 客廳、飯廳及睡房內部地板鋪砌複合木地板及髹油木腳線。 - 沿通往露台、工作平台、花園、平台及溫室的門之地台圍邊部分鋪砌天然石。
(d) 浴室	<ul style="list-style-type: none"> - 牆身鋪砌磁磚，部分地方鋪砌鏡及膠板(假天花以上、面盆櫃背及掛牆鏡櫃背除外)。 - 地台鋪砌天然石(浴缸底及面盆櫃底除外)。 - 裝設髹乳膠漆石膏板假天花。 - 牆身飾面鋪砌至假天花高度。
(e) 廚房	<ul style="list-style-type: none"> - 牆身鋪砌玻璃飾面及膠板飾面(假天花以上及櫥櫃背除外)。 - 地台鋪砌瓷磚(櫥櫃底除外)。 - 裝設髹乳膠漆石膏板及鋁質假天花。 - 灶台面為人造石材檯面。 - 牆身飾面鋪砌至假天花高度。

Remarks:

- In the description of residential property in a residential block, the prefix "G" means Garden Duplex unit and the numbering means the numbering of Garden Duplex unit of Block A, B, C, D, E or F (as the case may be). e.g. "G1" refers to Garden Duplex 1 of Block A, B, C, D, E or F (as the case may be).
- In the description of residential property in a residential block, the prefix "P" means Penthouse Triplex unit and the numbering means the numbering of Penthouse Triplex unit of Block A, B, D, E or F (as the case may be). e.g. "P1" refers to Penthouse Triplex 1 of Block A, B, D, E or F (as the case may be).
- In the description of residential property in a residential block the prefix "P" means Penthouse Duplex unit and the numbering means the numbering of Penthouse Duplex unit of Block C. e.g. "P1" refers to Penthouse Duplex 1 of Block C.

備註:

- 住宅大樓的住宅物業的描述中，字首「G」指花園複式單位，而編號指A、B、C、D、E或F座(視情況而定)的花園複式單位的編號。例如「G1」指A、B、C、D、E或F座(視情況而定)的花園複式1號單位。
- 住宅大樓中住宅物業的描述中，字首「P」指頂層三複式單位，而編號指A、B、D、E或F座(視情況而定)的頂層三複式單位的編號。例如「P1」指A、B、D、E或F座(視情況而定)的頂層三複式1號單位。
- 住宅大樓中住宅物業的描述中，字首「P」指頂層複式單位，而編號指C座的頂層複式單位的編號。例如「P1」指C座的頂層複式1號單位。

Fittings, finishes and appliances

裝置、裝修物料及設備

3. Interior fittings	
Item	Description
(a) Doors	<p>Main Entrance of Residential Property</p> <ul style="list-style-type: none"> - Solid core fire rated timber door with timber veneer finishes and painted stainless steel finishes. Fitted with lockset, handle, concealed door closer and eye viewer. <p>Entrance Hall (Private Lift Lobby) (Except Flat B, G/F of Tower 1 and Flat A and B, G/F of Tower 2-16) (4/F omitted, Tower 4, 13, 14 and 24 omitted)</p> <ul style="list-style-type: none"> - Solid core timber door with timber veneer finishes. Fitted with painted stainless steel handle. <p>Entrance Hall (Private Lift Lobby) (Flat B, G/F of Tower 1 and Flat A and B, G/F of Tower 2-16) (4/F omitted, Tower 4, 13, 14 and 24 omitted)</p> <ul style="list-style-type: none"> - Solid core fire rated timber door with timber veneer finishes. Fitted with painted stainless steel handle and concealed door closer. <p>Master Bedroom and Bedroom</p> <ul style="list-style-type: none"> - Solid core timber door with timber veneer finishes and fitted with lockset. <p>Kitchen</p> <ul style="list-style-type: none"> - Solid core fire rated timber door with timber veneer finishes and stainless steel finishes, and fitted with glass panel and door closer.

3. 室內裝置	
細項	描述
(a) 門	<p>住宅物業大門</p> <ul style="list-style-type: none"> - 選用實心防火木門配以木皮飾面及髹油不銹鋼飾面，裝設門鎖、門柄、暗藏氣鼓及防盜眼。 <p>入口大堂(私人升降機大堂) (除1座地下B單位及2至16座地下A及B單位) (不設4樓，不設4、13、14及24座)</p> <ul style="list-style-type: none"> - 選用實心木門配以木皮飾面，裝設髹油不銹鋼門柄。 <p>入口大堂(私人升降機大堂) (1座地下B單位及2至16座地下A及B單位) (不設4樓，不設4、13、14及24座)</p> <ul style="list-style-type: none"> - 選用實心防火木門配以木皮飾面，裝設髹油不銹鋼門柄及暗藏氣鼓。 <p>主人睡房及睡房</p> <ul style="list-style-type: none"> - 選用實心木門配以木皮飾面，裝設門鎖。 <p>廚房</p> <ul style="list-style-type: none"> - 選用實心防火木門配以木皮飾面及不銹鋼飾面，裝設玻璃窗及氣鼓。

Remarks:

1. In the description of residential property in a residential block, the prefix "G" means Garden Duplex unit and the numbering means the numbering of Garden Duplex unit of Block A, B, C, D, E or F (as the case may be). e.g. "G1" refers to Garden Duplex 1 of Block A, B, C, D, E or F (as the case may be).
2. In the description of residential property in a residential block, the prefix "P" means Penthouse Triplex unit and the numbering means the numbering of Penthouse Triplex unit of Block A, B, D, E or F (as the case may be). e.g. "P1" refers to Penthouse Triplex 1 of Block A, B, D, E or F (as the case may be).
3. In the description of residential property in a residential block, the prefix "P" means Penthouse Duplex unit and the numbering means the numbering of Penthouse Duplex unit of Block C. e.g. "P1" refers to Penthouse Duplex 1 of Block C.

備註:

1. 住宅大樓的住宅物業的描述中，字首「G」指花園複式單位，而編號指A、B、C、D、E或F座(視情況而定)的花園複式單位的編號。例如「G1」指A、B、C、D、E或F座(視情況而定)的花園複式1號單位。
2. 住宅大樓中住宅物業的描述中，字首「P」指頂層三複式單位，而編號指A、B、D、E或F座(視情況而定)的頂層三複式單位的編號。例如「P1」指A、B、D、E或F座(視情況而定)的頂層三複式1號單位。
3. 住宅大樓中住宅物業的描述中，字首「P」指頂層複式單位，而編號指C座的頂層複式單位的編號。例如「P1」指C座的頂層複式1號單位。

Fittings, finishes and appliances

裝置、裝修物料及設備

3. Interior fittings	
Item	Description
(a) Doors	<p>Store</p> <p>- Solid core timber door with plastic laminate finishes and fitted with door closer and lockset, except doors in the following residential properties, which are solid core fire rated timber door finished with timber veneer and fitted with door closer and lockset:</p> <p>Flat B and C, G/F, Tower 1 Flat B, 1/F to 7/F, Tower 1 Flat C, G/F, Tower 2 Flat E, 1/F to 6/F, Tower 2 Flat B and C, G/F, Tower 3 Flat C and E, 1/F to 6/F, Tower 3 Flat A and D, G/F, Tower 5 Flat D and E, 1/F to 6/F, Tower 5 Flat C, G/F, Tower 6 to 15 Flat E, 1/F to 6/F, Tower 6 to 16 Flat D, G/F to 6/F, Tower 17 Residential Unit G1 to G3 and G5 to G7, LG/F, Block C Residential Unit G1 to G3, G5 to G12 and G15 to G17, LG/F, Block D Residential Unit G1 to G3 and G5 to G7, LG/F, Block E Residential Unit G1 to G3 and G5, LG/F, Block F (4/F omitted, Tower 4, 13, 14 and 24 omitted)</p>

3. 室內裝置	
細項	描述
(a) 門	<p>儲物房</p> <p>- 選用實心木門配以膠板飾面，裝設氣鼓及門鎖；除以下住宅物業的門選用實心防火木門配以木皮飾面，裝設氣鼓及門鎖：</p> <p>1座地下B及C單位 1座1樓至7樓B單位 2座地下C單位 2座1樓至6樓E單位 3座地下B及C單位 3座1樓至6樓C及E單位 5座地下A及D單位 5座1樓至6樓D及E單位 6至15座地下C單位 6至16座1樓至6樓E單位 17座地下至6樓D單位 C座地下低層住宅單位G1至G3及G5至G7 D座地下低層住宅單位G1至G3、G5至G12及G15至G17 E座地下低層住宅單位G1至G3及G5至G7 F座地下低層住宅單位G1至G3及G5 (不設4樓，不設4、13、14及24座)</p>

Remarks:

- In the description of residential property in a residential block, the prefix "G" means Garden Duplex unit and the numbering means the numbering of Garden Duplex unit of Block A, B, C, D, E or F (as the case may be). e.g. "G1" refers to Garden Duplex 1 of Block A, B, C, D, E or F (as the case may be).
- In the description of residential property in a residential block, the prefix "P" means Penthouse Triplex unit and the numbering means the numbering of Penthouse Triplex unit of Block A, B, D, E or F (as the case may be). e.g. "P1" refers to Penthouse Triplex 1 of Block A, B, D, E or F (as the case may be).
- In the description of residential property in a residential block the prefix "P" means Penthouse Duplex unit and the numbering means the numbering of Penthouse Duplex unit of Block C. e.g. "P1" refers to Penthouse Duplex 1 of Block C.

備註:

- 住宅大樓的住宅物業的描述中，字首「G」指花園複式單位，而編號指A、B、C、D、E或F座(視情況而定)的花園複式單位的編號。例如「G1」指A、B、C、D、E或F座(視情況而定)的花園複式1號單位。
- 住宅大樓中住宅物業的描述中，字首「P」指頂層三複式單位，而編號指A、B、D、E或F座(視情況而定)的頂層三複式單位的編號。例如「P1」指A、B、D、E或F座(視情況而定)的頂層三複式1號單位。
- 住宅大樓中住宅物業的描述中，字首「P」指頂層複式單位，而編號指C座的頂層複式單位的編號。例如「P1」指C座的頂層複式1號單位。

Fittings, finishes and appliances

裝置、裝修物料及設備

3. Interior fittings	
Item	Description
(a) Doors	<p>Bathroom</p> <p>- Solid core timber door with timber veneer finishes and fitted with louvre and lockset.</p> <p>Master Bathroom</p> <p>- Painted stainless steel frame door fitted with glass panel and painted stainless steel handle and stainless steel louvre, except master bathroom in the following residential properties, which are solid core timber door with timber veneer finishes and fitted with louvre and lockset:</p> <p>Flat C, G/F to 6/F, Tower 17 Flat C and D, G/F to 6/F, Tower 18 to 21 Flat A to D, G/F, Tower 22 Flat A to E, 1/F to 3/F, Tower 22 Flat A to E, G/F, Tower 23 Flat A to F, 1/F to 3/F, Tower 23 Flat E and F, G/F, Tower 25 Flat A to D, 1/F to 3/F, Tower 25 (4/F omitted, Tower 4, 13, 14 and 24 omitted)</p> <p>Lavatory</p> <p>- Solid core timber door with timber veneer finishes and fitted with louvre and lockset.</p> <p>Lavatory in Store</p> <p>- Aluminium framed door fitted with glass panel and lockset.</p>

3. 室內裝置	
細項	描述
(a) 門	<p>浴室</p> <p>- 實心木門配以木皮飾面，裝設百葉及門鎖。</p> <p>主人房浴室</p> <p>- 髹油不銹鋼框玻璃門，裝設髹油不銹鋼門柄及不銹鋼百葉；除以下住宅物業配實心木門配以木皮飾面並裝設百葉及門鎖：</p> <p>17座地下至6樓C單位 18至21座地下至6樓C及D單位 22座地下A至D單位 22座1樓至3樓A至E單位 23座地下A至E單位 23座1樓至3樓A至F單位 25座地下E及F單位 25座1樓至3樓A至D單位 (不設4樓，不設4、13、14及24座)</p> <p>洗手間</p> <p>- 實心木門配以木皮飾面，裝設百葉及門鎖。</p> <p>儲物房洗手間</p> <p>- 鋁框玻璃門，裝設門鎖。</p>

Remarks:

- In the description of residential property in a residential block, the prefix "G" means Garden Duplex unit and the numbering means the numbering of Garden Duplex unit of Block A, B, C, D, E or F (as the case may be). e.g. "G1" refers to Garden Duplex 1 of Block A, B, C, D, E or F (as the case may be).
- In the description of residential property in a residential block, the prefix "P" means Penthouse Triplex unit and the numbering means the numbering of Penthouse Triplex unit of Block A, B, D, E or F (as the case may be). e.g. "P1" refers to Penthouse Triplex 1 of Block A, B, D, E or F (as the case may be).
- In the description of residential property in a residential block, the prefix "P" means Penthouse Duplex unit and the numbering means the numbering of Penthouse Duplex unit of Block C. e.g. "P1" refers to Penthouse Duplex 1 of Block C.

備註:

- 住宅大樓的住宅物業的描述中，字首「G」指花園複式單位，而編號指A、B、C、D、E或F座(視情況而定)的花園複式單位的編號。例如「G1」指A、B、C、D、E或F座(視情況而定)的花園複式1號單位。
- 住宅大樓中住宅物業的描述中，字首「P」指頂層三複式單位，而編號指A、B、D、E或F座(視情況而定)的頂層三複式單位的編號。例如「P1」指A、B、D、E或F座(視情況而定)的頂層三複式1號單位。
- 住宅大樓中住宅物業的描述中，字首「P」指頂層複式單位，而編號指C座的頂層複式單位的編號。例如「P1」指C座的頂層複式1號單位。

Fittings, finishes and appliances

裝置、裝修物料及設備

3. Interior fittings	
Item	Description
(a) Doors	<p>Garden</p> <p>- Folding doors of fluorocarbon coated aluminium frame fitted with single pane glass and lockset are provided at the garden in the residential properties except garden in the following units, at which fluorocarbon coated aluminium framed glass door fitted with lockset is provided:</p> <p>Flat A and B, G/F, Tower 2 to 3, 5 to 12 and 15 to 16 Flat A, G/F, Tower 5 Flat A and B, G/F, Tower 17 (at master bedroom) Flat A to D, G/F, Tower 17 to 21 Flat B to D, G/F, Tower 22 Flat A to E, G/F, Tower 23 Flat E and F, G/F, Tower 25 Residential Unit G1 to G3 and G5 to G7, G/F, Block C Residential Unit G1 to G3, G5 to G12 and G15 to G17, G/F, Block D Residential Unit G1 to G3 and G5 to G7, G/F, Block E (at bedroom 4)</p> <p>Utility Platform</p> <p>- Fluorocarbon coated aluminium framed glass door fitted with lockset is provided.</p>

3. 室內裝置	
細項	描述
(a) 門	<p>花園</p> <p>- 氟化碳噴鋁框單片玻璃摺門，裝設門鎖，設於住宅物業的花園；除以下住宅物業的花園配氟化碳噴鋁框玻璃門，裝設門鎖：</p> <p>2至3、5至12及15至16座地下A至B單位 5座地下A單位 17座地下A及B單位(位於主人睡房) 17至21座地下A至D單位 22座地下B至D單位 23座地下A至E單位 25座地下E及F單位 C座地下住宅單位G1至G3及G5至G7 D座地下住宅單位G1至G3、G5至G12及G15至G17 E座地下住宅單位G1至G3及G5至G7(位於睡房4)</p> <p>工作平台</p> <p>- 氟化碳噴鋁框玻璃門，裝設門鎖。</p>

Remarks:

- In the description of residential property in a residential block, the prefix "G" means Garden Duplex unit and the numbering means the numbering of Garden Duplex unit of Block A, B, C, D, E or F (as the case may be). e.g. "G1" refers to Garden Duplex 1 of Block A, B, C, D, E or F (as the case may be).
- In the description of residential property in a residential block, the prefix "P" means Penthouse Triplex unit and the numbering means the numbering of Penthouse Triplex unit of Block A, B, D, E or F (as the case may be). e.g. "P1" refers to Penthouse Triplex 1 of Block A, B, D, E or F (as the case may be).
- In the description of residential property in a residential block the prefix "P" means Penthouse Duplex unit and the numbering means the numbering of Penthouse Duplex unit of Block C. e.g. "P1" refers to Penthouse Duplex 1 of Block C.

備註:

- 住宅大樓的住宅物業的描述中，字首「G」指花園複式單位，而編號指A、B、C、D、E或F座(視情況而定)的花園複式單位的編號。例如「G1」指A、B、C、D、E或F座(視情況而定)的花園複式1號單位。
- 住宅大樓中住宅物業的描述中，字首「P」指頂層三複式單位，而編號指A、B、D、E或F座(視情況而定)的頂層三複式單位的編號。例如「P1」指A、B、D、E或F座(視情況而定)的頂層三複式1號單位。
- 住宅大樓中住宅物業的描述中，字首「P」指頂層複式單位，而編號指C座的頂層複式單位的編號。例如「P1」指C座的頂層複式1號單位。

Fittings, finishes and appliances

裝置、裝修物料及設備

3. Interior fittings	
Item	Description
(a) Doors	<p>Balcony</p> <p>- Folding doors of flurocarbon coated aluminium frame fitted with single pane glass and lockset are provided at the balcony in residential properties except balcony in the following residential properties, at which flurocarbon coated aluminium framed glass door fitted with lockset is provided:</p> <p>Flat C, 2/F to 6/F, Tower 1 Flat D, 7/F, Tower 1 Flat C to E, 2/F to 6/F, Tower 2 to 3, 5 to 12 and 15 to 16 Flat B, 1/F to 7/F, Tower 16 (at master bedroom) Flat A and B, 1/F to 6/F, Tower 17 (at living room and dining room) Flat B, 1/F to 6/F, Tower 17 (at master bedroom) Flat C and D, 2/F to 6/F, Tower 17 to 21 Flat A and B, 1/F to 6/F, Tower 18 to 21 Flat B to E, 1/F to 3/F, Tower 22 Flat A to F, 1/F to 3/F, Tower 23 Flat A to D, G/F, Tower 25 Flat A to D, 2/F to 3/F, Tower 25 Residential Unit G1 to G3 and G5, G/F, Block A and B Residential Unit P1 to P3 and P5, 3/F, Block A and B Residential Unit G1 to G3 and G5 to G7, G/F, Block C Residential Unit P1 to P3 and P5 to P7, 2/F, Block C Residential Unit G1 to G3, G5 to G12 and G15 to G17, G/F, Block D Residential Unit P1 to P3, P5 to P12 and P15 to P17, 2/F, Block D Residential Unit G1 to G3 and G5 to G7, G/F, Block E Residential Unit P1 to P3 and P5 to P7, 2/F, Block E Residential Unit G1 to G3 and G5, G/F, Block F Residential Unit P1 to P3 and P5, 2/F, Block F</p>

3. 室內裝置	
細項	描述
(a) 門	<p>露台</p> <p>- 氟化碳噴鋁框單片玻璃摺門，裝設門鎖，設於住宅物業的露台；除以下住宅物業的露台配氟化碳噴鋁框玻璃門，裝設門鎖：</p> <p>1座2樓至6樓C單位 1座7樓D單位 2至3、5至12及15至16座2樓至6樓C至E單位 16座1樓至7樓B單位(位於主人睡房) 17座1樓至6樓A及B單位(位於客廳及飯廳) 17座1樓至6樓B單位(位於主人睡房) 17至21座2樓至6樓C及D單位 18至21座1樓至6樓A及B單位 22座1樓至3樓B至E單位 23座1樓至3樓A至F單位 25座地下A至D單位 25座2樓至3樓A至D單位 A及B座地下住宅單位G1至G3及G5 A及B座3樓住宅單位P1至P3及P5 C座地下住宅單位G1至G3及G5至G7 C座2樓住宅單位P1至P3及P5至P7 D座地下住宅單位G1至G3、G5至G12及G15至G17 D座2樓住宅單位P1至P3、P5至P12及P15至P17 E座地下住宅單位G1至G3及G5至G7 E座2樓住宅單位P1至P3及P5至P7 F座地下住宅單位G1至G3及G5 F座2樓住宅單位P1至P3及P5單位</p>

Remarks:

- In the description of residential property in a residential block, the prefix "G" means Garden Duplex unit and the numbering means the numbering of Garden Duplex unit of Block A, B, C, D, E or F (as the case may be). e.g. "G1" refers to Garden Duplex 1 of Block A, B, C, D, E or F (as the case may be).
- In the description of residential property in a residential block, the prefix "P" means Penthouse Triplex unit and the numbering means the numbering of Penthouse Triplex unit of Block A, B, D, E or F (as the case may be). e.g. "P1" refers to Penthouse Triplex 1 of Block A, B, D, E or F (as the case may be).
- In the description of residential property in a residential block the prefix "P" means Penthouse Duplex unit and the numbering means the numbering of Penthouse Duplex unit of Block C. e.g. "P1" refers to Penthouse Duplex 1 of Block C.

備註:

- 住宅大樓的住宅物業的描述中，字首「G」指花園複式單位，而編號指A、B、C、D、E或F座(視情況而定)的花園複式單位的編號。例如「G1」指A、B、C、D、E或F座(視情況而定)的花園複式1號單位。
- 住宅大樓中住宅物業的描述中，字首「P」指頂層三複式單位，而編號指A、B、D、E或F座(視情況而定)的頂層三複式單位的編號。例如「P1」指A、B、D、E或F座(視情況而定)的頂層三複式1號單位。
- 住宅大樓中住宅物業的描述中，字首「P」指頂層複式單位，而編號指C座的頂層複式單位的編號。例如「P1」指C座的頂層複式1號單位。

Fittings, finishes and appliances

裝置、裝修物料及設備

3. Interior fittings	
Item	Description
(a) Doors	<p>Door to Flat Roof and Common Flat Roof</p> <p>- Fluorocarbon coated aluminium framed glass door fitted with lockset is provided at the flat roof and common flat roof in the residential properties, except for flat roof and common flat roof in the following residential properties, at which folding doors of fluorocarbon coated aluminium frame fitted with single pane glass and lockset are provided:</p> <p>Residential Unit P1 to P3 and P5, I/F, Block A and B Residential Unit P1 to P3 and P5 to P7, I/F, Block C Residential Unit P1 to P3, P5 to P12 and P15 to P17, I/F, Block D Residential Unit P1 to P3 and P5 to P7, I/F, Block E Residential Unit P1 to P3 and P5, I/F, Block F</p> <p>Conservatory</p> <p>- Fluorocarbon coated aluminium framed glass door fitted with lockset is provided at the conservatory in the residential properties except for conservatory in the following residential properties, at which folding doors of fluorocarbon coated aluminium frame fitted with single pane glass and lockset are provided:</p> <p>Flat B, G/F to 7/F, Tower 1 Flat A and B, G/F to 7/F, Tower 2 to 3, 5 to 12 and 15 Flat D, 7/F, Tower 2 to 3, 6 to 12 and 15 to 16 Flat C, 7/F, Tower 3, 5 to 12 and 15 Flat A, G/F to 7/F, Tower 16</p>

3. 室內裝置	
細項	描述
(a) 門	<p>通往平台及公用平台門扇</p> <p>- 氟化碳噴鋁框玻璃門，裝設門鎖，設於住宅物業的平台及公用平台；除以下住宅物業的平台及公用平台配氟化碳噴鋁框單片玻璃摺門，裝設門鎖：</p> <p>A及B座1樓住宅單位P1至P3及P5 C座1樓住宅單位P1至P3及P5至P7 D座1樓住宅單位P1至P3、P5至P12及P15至P17 E座1樓住宅單位P1至P3及P5至P7 F座1樓住宅單位P1至P3及P5</p> <p>溫室</p> <p>- 氟化碳噴鋁框玻璃門，裝設門鎖，設於住宅物業的溫室；除以下住宅物業的溫室配氟化碳噴鋁框玻璃摺門，裝設門鎖：</p> <p>1座地下至7樓B單位 2至3、5至12及15座地下至7樓A及B單位 2至3、6至12及15至16座7樓D單位 3、5至12及15座7樓C單位 16座地下至7樓A單位</p>

Remarks:

- In the description of residential property in a residential block, the prefix "G" means Garden Duplex unit and the numbering means the numbering of Garden Duplex unit of Block A, B, C, D, E or F (as the case may be). e.g. "G1" refers to Garden Duplex 1 of Block A, B, C, D, E or F (as the case may be).
- In the description of residential property in a residential block, the prefix "P" means Penthouse Triplex unit and the numbering means the numbering of Penthouse Triplex unit of Block A, B, D, E or F (as the case may be). e.g. "P1" refers to Penthouse Triplex 1 of Block A, B, D, E or F (as the case may be).
- In the description of residential property in a residential block, the prefix "P" means Penthouse Duplex unit and the numbering means the numbering of Penthouse Duplex unit of Block C. e.g. "P1" refers to Penthouse Duplex 1 of Block C.

備註:

- 住宅大樓的住宅物業的描述中，字首「G」指花園複式單位，而編號指A、B、C、D、E或F座(視情況而定)的花園複式單位的編號。例如「G1」指A、B、C、D、E或F座(視情況而定)的花園複式1號單位。
- 住宅大樓中住宅物業的描述中，字首「P」指頂層三複式單位，而編號指A、B、D、E或F座(視情況而定)的頂層三複式單位的編號。例如「P1」指A、B、D、E或F座(視情況而定)的頂層三複式1號單位。
- 住宅大樓中住宅物業的描述中，字首「P」指頂層複式單位，而編號指C座的頂層複式單位的編號。例如「P1」指C座的頂層複式1號單位。

Fittings, finishes and appliances

裝置、裝修物料及設備

3. Interior fittings	
Item	Description
(b) Bathroom	<p>Master Bathroom</p> <ul style="list-style-type: none"> - Timber vanity counter with natural stone counter top. Sanitary wares and fittings include vitreous china wash basin with chrome plated wash basin mixer; vitreous china water closet fitted with toilet paper holder. - Enamel finished pressed steel bathtub (1600mm (L) X 700mm (W) X 430mm (D)), fitted with bathtub mixer set. - Tempered glass shower cubicle and chrome plated shower mixer set provided for master bathrooms with shower cubicles. - Copper pipes are used for cold and hot water supply system. - uPVC pipes are used for flushing water supply system. - Ventilation system is provided. <p>Bathroom</p> <ul style="list-style-type: none"> - Timber vanity counter with natural stone counter top. Sanitary wares and fittings include vitreous china wash basin with chrome plated wash basin mixer; vitreous china water closet fitted with toilet paper holder. - Enamel finished pressed steel bathtub (1500mm (L) X 700mm (W) X 390mm (D)), fitted with bathtub mixer set provided for bathrooms with bathtub. - Tempered glass shower cubicle and chrome plated shower mixer set provided for bathrooms with shower cubicle. - Copper pipes are used for cold and hot water supply system. - uPVC pipes are used for flushing water supply system. - Ventilation system is provided.
(c) Kitchen	<ul style="list-style-type: none"> - Stainless steel sink with chrome plated sink mixer. - Copper pipes are used for cold and hot water supply system. - Fitted with timber kitchen cabinet with plastic laminate finishes and gloss paint finishes, door panel with plastic laminate finishes and gloss paint finishes, artificial stone surface material countertop. - For appliances provisions, please refer to the "Appliances Schedule".
(d) Bedroom	<ul style="list-style-type: none"> - Manually operated sheer curtain is provided.
(e) Telephone	<ul style="list-style-type: none"> - Telephone connection points are provided. For location and number of connection points, please refer to the "Mechanical & Electrical Provisions Plan" and "Schedule of Mechanical & Electrical Provisions of Residential Properties".

3. 室內裝置	
細項	描述
(b) 浴室	<p>主人房浴室</p> <ul style="list-style-type: none"> - 天然石檯面木製儲物櫃。潔具及裝置包括陶瓷洗手盆配鍍鉻洗手盆水龍頭，陶瓷坐廁及廁紙架。 - 瓷釉壓製鋼浴缸(1600毫米(長) x 700毫米(闊) x 430毫米(深))，設有浴缸花灑龍頭套裝。 - 設有淋浴間的主人房浴室，裝置強化玻璃淋浴間及設鍍鉻花灑套裝。 - 冷熱水供水系統採用銅喉管。 - 沖廁供水系統採用膠喉管。 - 配備通風系統。 <p>浴室</p> <ul style="list-style-type: none"> - 天然石檯面木製儲物櫃。潔具及裝置包括陶瓷洗手盆配鍍鉻洗手盆水龍頭，陶瓷坐廁及廁紙架。 - 設有浴缸的浴室，裝置瓷釉壓製鋼浴缸(1500毫米(長) x 700毫米(闊) x 390毫米(深))並設有浴缸花灑龍頭套裝。 - 設有淋浴間的浴室，裝置強化玻璃淋浴間及設鍍鉻花灑套裝。 - 冷熱水供水系統採用銅喉管。 - 沖廁供水系統採用膠喉管。 - 配備通風系統。
(c) 廚房	<ul style="list-style-type: none"> - 不銹鋼洗滌盆配鍍鉻洗滌盆水龍頭。 - 冷熱水供水系統採用銅喉管。 - 木製廚櫃組合配以膠板飾面及高光漆飾面，膠板飾面及高光漆飾面門板，人造石枱面。 - 有關供應之設備，請參閱「設備說明表」。
(d) 睡房	<ul style="list-style-type: none"> - 設有手動窗紗。
(e) 電話	<ul style="list-style-type: none"> - 裝設電話插座。有關接駁點的位置及數量，請參考「機電裝置平面圖」及「住宅物業機電裝置數量說明表」。

Remarks:

1. In the description of residential property in a residential block, the prefix "G" means Garden Duplex unit and the numbering means the numbering of Garden Duplex unit of Block A, B, C, D, E or F (as the case may be). e.g. "G1" refers to Garden Duplex 1 of Block A, B, C, D, E or F (as the case may be).
2. In the description of residential property in a residential block, the prefix "P" means Penthouse Triplex unit and the numbering means the numbering of Penthouse Triplex unit of Block A, B, D, E or F (as the case may be). e.g. "P1" refers to Penthouse Triplex 1 of Block A, B, D, E or F (as the case may be).
3. In the description of residential property in a residential block, the prefix "P" means Penthouse Duplex unit and the numbering means the numbering of Penthouse Duplex unit of Block C. e.g. "P1" refers to Penthouse Duplex 1 of Block C.

備註:

1. 住宅大樓的住宅物業的描述中，字首「G」指花園複式單位，而編號指A、B、C、D、E或F座(視情況而定)的花園複式單位的編號。例如「G1」指A、B、C、D、E或F座(視情況而定)的花園複式1號單位。
2. 住宅大樓中住宅物業的描述中，字首「P」指頂層三複式單位，而編號指A、B、D、E或F座(視情況而定)的頂層三複式單位的編號。例如「P1」指A、B、D、E或F座(視情況而定)的頂層三複式1號單位。
3. 住宅大樓中住宅物業的描述中，字首「P」指頂層複式單位，而編號指C座的頂層複式單位的編號。例如「P1」指C座的頂層複式1號單位。

Fittings, finishes and appliances

裝置、裝修物料及設備

3. Interior fittings	
Item	Description
(f) Aerials	- Communal TV/FM points are provided. For location and number of connection points, please refer to the "Mechanical & Electrical Provisions Plan" and "Schedule of Mechanical & Electrical Provisions of Residential Properties".
(g) Electrical installations	- Three-phase electricity supply with miniature circuit breaker distribution board is provided. - Conduits are partly concealed and partly exposed *. - For location and number of sockets and air-conditioner points, please refer to the "Mechanical & Electrical Provisions Plan" and "Schedule of Mechanical & Electrical Provisions of Residential Properties". * Note : Other than those parts of the conduits concealed within concrete, the rest of them are exposed. Exposed conduits are mostly covered or hidden by false ceilings, bulkheads, cabinets, claddings, non-concrete walls, pipe ducts or other materials and are not readily visible.
(h) Gas supply	- Town gas supply pipes are connected to gas cooking hob and gas water heater. - Separate town gas meters are provided on G/F for the following residential properties: Residential Unit P1 to P3 and P5, Block A and B Residential Unit G1 to G3 and G5 to G7, Block C Residential Unit P1 to P3 and P5 to P7, Block C - Separate town gas meters are provided on roof in the following residential properties: Residential Unit P1 to P3, P5 to P12 and P15 to P17, Block D Residential Unit P1 to P3 and P5 to P7, Block E Residential Unit P1 to P3 and P5, Block F - Separate town gas meters in residential properties other than the above are provided in the kitchen.
(i) Washing machine connection point	- Drain point and water point are provided for washing machine. For location of connection points, please refer to the "Mechanical & Electrical Provisions Plan".
(j) Water supply	- Copper pipes are used for cold and hot water supply system. - uPVC pipes are used for flushing water supply system. - Water pipes are partly concealed and partly exposed *. * Note : Other than those parts of the water pipes concealed within concrete, the rest of them are exposed. Some of the exposed water pipes are covered or hidden by false ceilings, bulkheads, cabinets, claddings, non-concrete walls, pipe ducts or other materials and are not readily visible.

3. 室內裝置	
細項	描述
(f) 天線	- 裝設公共電視/電台接收插座。有關接駁點的位置及數量，請參考「機電裝置平面圖」及「住宅物業機電裝置數量說明表」。
(g) 電力裝置	- 提供三相電力配電箱並裝置有微型斷路器。 - 導管是部分隱藏及部分外露*。 - 有關電插座及空調機接駁點的位置及數目，請參考「機電裝置平面圖」及「住宅物業機電裝置數量說明表」。 * 註釋：除部分隱藏於混凝土內之導管外，其他部分的導管均為外露。外露的導管大部分以假天花、假陣、櫃、飾面板、非混凝土牆、管道槽或其他物料覆蓋或掩藏，並不容易看見。
(h) 氣體供應	- 煤氣喉接駁煤氣煮食爐及煤氣熱水爐。 - 以下住宅物業的獨立煤氣錶位於地下： A及B座住宅單位P1至P3及P5 C座住宅單位G1至G3及G5至G7 C座住宅單位P1至P3及P5至P7 - 以下住宅物業的獨立煤氣錶位於天台： D座住宅單位P1至P3、P5至P12及P15至P17 E座住宅單位P1至P3及P5至P7 F座住宅單位P1至P3及P5 - 除上述外其他住宅物業的獨立煤氣錶位於廚房。
(i) 洗衣機接駁點	- 洗衣機配備來水及去水接駁點。有關接駁點的位置，請參考「機電裝置平面圖」。
(j) 供水	- 冷熱水供水系統採用銅喉管。 - 沖廁供水系統採用膠喉管。 - 水管是部分隱藏及部分外露*。 * 註釋：除部分隱藏於混凝土內之水管外，其他部分的水管均為外露。部分外露的水管以假天花、假陣、櫃、飾面板、非混凝土牆、管道槽或其他物料覆蓋或掩藏，並不容易看見。

Remarks:

- In the description of residential property in a residential block, the prefix "G" means Garden Duplex unit and the numbering means the numbering of Garden Duplex unit of Block A, B, C, D, E or F (as the case may be). e.g. "G1" refers to Garden Duplex 1 of Block A, B, C, D, E or F (as the case may be).
- In the description of residential property in a residential block, the prefix "P" means Penthouse Triplex unit and the numbering means the numbering of Penthouse Triplex unit of Block A, B, D, E or F (as the case may be). e.g. "P1" refers to Penthouse Triplex 1 of Block A, B, D, E or F (as the case may be).
- In the description of residential property in a residential block the prefix "P" means Penthouse Duplex unit and the numbering means the numbering of Penthouse Duplex unit of Block C. e.g. "P1" refers to Penthouse Duplex 1 of Block C.

備註:

- 住宅大樓的住宅物業的描述中，字首「G」指花園複式單位，而編號指A、B、C、D、E或F座(視情況而定)的花園複式單位的編號。例如「G1」指A、B、C、D、E或F座(視情況而定)的花園複式1號單位。
- 住宅大樓中住宅物業的描述中，字首「P」指頂層三複式單位，而編號指A、B、D、E或F座(視情況而定)的頂層三複式單位的編號。例如「P1」指A、B、D、E或F座(視情況而定)的頂層三複式1號單位。
- 住宅大樓中住宅物業的描述中，字首「P」指頂層複式單位，而編號指C座的頂層複式單位的編號。例如「P1」指C座的頂層複式1號單位。

Fittings, finishes and appliances

裝置、裝修物料及設備

4. Miscellaneous	
Item	Description
(a) Lifts	<p>Residential Tower</p> <ul style="list-style-type: none"> - Tower 1 to 3, 5 to 12 and 15 to 16 - 2 nos. of "Schindler" (model no.: Schindler 5500) lifts serve B/F, G/F, I/F to 3/F and 5/F to 7/F. (Tower 4, 13, 14 and 24 omitted) - Tower 17 to 21 - 1 no. of "Schindler" (model no.: Schindler 5500) lift serves B/F, G/F, I/F to 3/F and 5/F to 6/F. - Tower 22 and 23 - 1 no. of "Schindler" (model no.: Schindler 5500) lift serves B/F, G/F, and I/F to 3/F. - Tower 25 - 2 nos. of "Schindler" (model no.: Schindler 5500) lifts serve LG/F, G/F and I/F to 3/F. <p>Residential Block</p> <ul style="list-style-type: none"> - Block A and B - 2 nos. of "Schindler" (model no.: Schindler 5500) lifts serve B/F, G/F and I/F to 2/F. - Block C - 3 nos. of "Schindler" (model no.: Schindler 5500) lifts serve B/F, G/F and I/F. - Block D - 7 nos. of "Schindler" (model no.: Schindler 5500) lifts serve B/F, LG/F, G/F and I/F to 2/F. - Block E - 3 nos. of "Schindler" (model no.: Schindler 5500) lifts serve B/F, LG/F, G/F, and I/F to 2/F. - Block F - 2 nos. of "Schindler" (model no.: Schindler 5500) lifts serve B/F, LG/F, G/F and I/F to 2/F. <p>Clubhouse</p> <ul style="list-style-type: none"> - 1 no. of "Schindler" (model no.: Schindler 5500) lift serves LG/F, Mezzanine Floor, G/F and I/F. - 1 no. of "Garaventa Lift" (model no.: GVL-SW) vertical lifting platform serves B/F and LG/F.

4. 雜項	
細項	描述
(a) 升降機	<p>住宅大廈</p> <ul style="list-style-type: none"> - 1至3、5至12及15至16座 - 設有2部“迅達”升降機(型號: Schindler 5500)直達地庫、地下、1樓至3樓及5樓至7樓。(不設4、13、14及24座) - 17至21座 - 設有1部“迅達”升降機(型號: Schindler 5500)直達地庫、地下、1樓至3樓及5樓至6樓。 - 22及23座 - 設有1部“迅達”升降機(型號: Schindler 5500)直達地庫、地下及1樓至3樓。 - 25座 - 設有2部“迅達”升降機(型號: Schindler 5500)直達地下低層、地下及1樓至3樓。 <p>住宅大樓</p> <ul style="list-style-type: none"> - A及B座 - 設有2部“迅達”升降機(型號: Schindler 5500)直達地庫、地下及1樓至2樓。 - C座 - 設有3部“迅達”升降機(型號: Schindler 5500)直達地庫、地下及1樓。 - D座 - 設有7部“迅達”升降機(型號: Schindler 5500)直達地庫、地下低層、地下及1樓至2樓。 - E座 - 設有3部“迅達”升降機(型號: Schindler 5500)直達地庫、地下低層、地下及1樓至2樓。 - F座 - 設有2部“迅達”升降機(型號: Schindler 5500)直達地庫、地下低層、地下及1樓至2樓。 <p>會所</p> <ul style="list-style-type: none"> - 設有1部“迅達”升降機(型號: Schindler 5500)直達地下低層、地下低層夾層、地下及1樓。 - 設有1部“Garaventa Lift”垂直升降台(型號: GVL-SW)直達地庫及地下低層。

The vendor undertakes that if lifts or appliances of the specified brand name or model number are not installed in the Development, lifts or appliances of comparable quality will be installed.

賣方承諾如發展項目中沒有安裝指明的品牌名稱或產品型號的升降機或設備，便會安裝品質相若的升降機或設備。

Remarks:

1. In the description of residential property in a residential block, the prefix "G" means Garden Duplex unit and the numbering means the numbering of Garden Duplex unit of Block A, B, C, D, E or F (as the case may be). e.g. "G1" refers to Garden Duplex 1 of Block A, B, C, D, E or F (as the case may be).
2. In the description of residential property in a residential block, the prefix "P" means Penthouse Triplex unit and the numbering means the numbering of Penthouse Triplex unit of Block A, B, D, E or F (as the case may be). e.g. "P1" refers to Penthouse Triplex 1 of Block A, B, D, E or F (as the case may be).
3. In the description of residential property in a residential block, the prefix "P" means Penthouse Duplex unit and the numbering means the numbering of Penthouse Duplex unit of Block C. e.g. "P1" refers to Penthouse Duplex 1 of Block C.

備註:

1. 住宅大樓的住宅物業的描述中，字首「G」指花園複式單位，而編號指A、B、C、D、E或F座(視情況而定)的花園複式單位的編號。例如「G1」指A、B、C、D、E或F座(視情況而定)的花園複式1號單位。
2. 住宅大樓中住宅物業的描述中，字首「P」指頂層三複式單位，而編號指A、B、D、E或F座(視情況而定)的頂層三複式單位的編號。例如「P1」指A、B、D、E或F座(視情況而定)的頂層三複式1號單位。
3. 住宅大樓中住宅物業的描述中，字首「P」指頂層複式單位，而編號指C座的頂層複式單位的編號。例如「P1」指C座的頂層複式1號單位。

Fittings, finishes and appliances

裝置、裝修物料及設備

4. Miscellaneous	
Item	Description
(b) Letter box	- Metal letter box is provided.
(c) Refuse collection	<p>Residential Tower</p> <ul style="list-style-type: none"> - Refuse storage and material recovery room is provided in the common area of each residential floor of tower except that LG/F of Tower 25 is not provided with refuse storage and material recovery room. - A central refuse storage and material recovery chamber is provided at Basement for collection and removal of refuse by cleaners. <p>Residential Block</p> <ul style="list-style-type: none"> - Refuse storage and material recovery room is provided in the common area of Basement and 1/F. - A central refuse storage and material recovery chamber is provided at Basement for collection and removal of refuse by cleaners.

4. 雜項	
細項	描述
(b) 信箱	- 設有金屬信箱。
(c) 垃圾收集	<p>住宅大廈</p> <ul style="list-style-type: none"> - 垃圾及物料回收室位於住宅大廈每層住宅樓層之公用地方；除25座地下低層不設垃圾及物料回收室。 - 垃圾及物料由清潔工人收集及運送至地庫的公用垃圾及物料回收房作中央處理及移走。 <p>住宅大樓</p> <ul style="list-style-type: none"> - 垃圾及物料回收室位於地庫及一樓之公用地方。 - 垃圾及物料由清潔工人收集及運送至地庫的公用垃圾及物料回收房作中央處理及移走。

Remarks:

1. In the description of residential property in a residential block, the prefix "G" means Garden Duplex unit and the numbering means the numbering of Garden Duplex unit of Block A, B, C, D, E or F (as the case may be). e.g. "G1" refers to Garden Duplex 1 of Block A, B, C, D, E or F (as the case may be).
2. In the description of residential property in a residential block, the prefix "P" means Penthouse Triplex unit and the numbering means the numbering of Penthouse Triplex unit of Block A, B, D, E or F (as the case may be). e.g. "P1" refers to Penthouse Triplex 1 of Block A, B, D, E or F (as the case may be).
3. In the description of residential property in a residential block the prefix "P" means Penthouse Duplex unit and the numbering means the numbering of Penthouse Duplex unit of Block C. e.g. "P1" refers to Penthouse Duplex 1 of Block C.

備註:

1. 住宅大樓的住宅物業的描述中，字首「G」指花園複式單位，而編號指A、B、C、D、E或F座(視情況而定)的花園複式單位的編號。例如「G1」指A、B、C、D、E或F座(視情況而定)的花園複式1號單位。
2. 住宅大樓中住宅物業的描述中，字首「P」指頂層三複式單位，而編號指A、B、D、E或F座(視情況而定)的頂層三複式單位的編號。例如「P1」指A、B、D、E或F座(視情況而定)的頂層三複式1號單位。
3. 住宅大樓中住宅物業的描述中，字首「P」指頂層複式單位，而編號指C座的頂層複式單位的編號。例如「P1」指C座的頂層複式1號單位。

裝置、裝修物料及設備

4. Miscellaneous	
Item	Description
(d) Water meter, electricity meter and gas meter	<p>Water Meter</p> <p>Residential Tower</p> <ul style="list-style-type: none"> - Separate water meter for individual residential property is provided in the water meter cabinet on each residential floor of tower except that: Separate water meter for Duplex unit on LG/F and G/F, Tower 25 is provided in the water meter cabinet on Basement. Separate water meter for Flats A to D, I/F to 3/F, Tower 25 is provided in the water meter cabinet on G/F. <p>Residential Block</p> <ul style="list-style-type: none"> - Separate water meter for individual residential property in Block A and B is provided in the water meter cabinet on I/F of the respective block. - Separate water meter for individual residential property in Block C is provided in the water meter cabinet on Basement of the respective block. - Separate water meter for individual residential property in Block D to F is provided in the water meter cabinet on G/F of the respective block. <p>Electricity meter</p> <ul style="list-style-type: none"> - Separate electricity meter for individual residential property in Block C to F is provided in the electricity meter room on Basement of the respective block. - Separate electricity meter for individual residential property in Block A and B and Tower 22 and 23 is provided in the electricity meter room on G/F of the respective block. - Separate electricity meter for individual residential property on 7/F, Tower 2, 6 to 16 is provided in the electricity meter room on 6/F of the respective tower. - Separate electricity meter for individual residential property of tower other than the above is provided in the electricity meter room on each residential floor. <p>Town gas meter</p> <ul style="list-style-type: none"> - Separate town gas meters are provided on G/F for the following residential properties: Residential Unit P1 to P3 and P5, Block A and B Residential Unit G1 to G3 and G5 to G7, Block C Residential Unit P1 to P3 and P5 to P7, Block C - Separate town gas meters are provided on the roof in the following residential properties: Residential Unit P1 to P3, P5 to P12 and P15 to P17, Block D Residential Unit P1 to P3 and P5 to P7, Block E Residential Unit P1 to P3 and P5, Block F - Separate town gas meters in residential properties other than the above are provided in the kitchen.

4. 雜項	
細項	描述
(d) 水錶、電錶及氣體錶	<p>水錶</p> <p>住宅大廈</p> <ul style="list-style-type: none"> - 每戶住宅物業之獨立水錶安裝於大廈每層住宅樓層之水錶箱內除： 25座地下低層(複式單位)及地下單位的獨立水錶位於地庫之水錶箱內 25座1樓至3樓A至D單位的獨立水錶，位於地下之水錶箱內 <p>住宅大樓</p> <ul style="list-style-type: none"> - A及B座之每戶住宅物業的獨立水錶設於該座1樓之水錶箱內 - C座之每戶住宅物業的獨立水錶設於該座地庫之水錶箱內 - D至F座之每戶住宅物業的獨立水錶設於該座地下之水錶箱內 <p>電錶</p> <ul style="list-style-type: none"> - C至F座之每戶住宅物業之獨立電錶安裝於該座地庫之電錶房內。 - A、B、22及23座之每戶住宅物業之獨立電錶安裝於該座地下之電錶房內。 - 2及6至16座之7樓的住宅物業之獨立電錶安裝於該座6樓住宅樓層之電錶房內。 - 除上述外其他住宅物業之獨立電錶安裝於住宅大廈每層住宅樓層之電錶房內。 <p>煤氣錶</p> <ul style="list-style-type: none"> - 以下住宅物業的獨立煤氣錶位於地下： A及B座住宅單位P1至P3及P5 C座住宅單位G1至G3及G5至G7 C座住宅單位P1至P3及P5至P7 - 以下住宅物業的獨立煤氣錶位於天台： D座住宅單位P1至P3、P5至P12及P15至P17 E座住宅單位P1至P3及P5至P7 F座住宅單位P1至P3及P5 - 除上述外其他住宅物業的獨立煤氣錶位於廚房。

Remarks:

1. In the description of residential property in a residential block, the prefix "G" means Garden Duplex unit and the numbering means the numbering of Garden Duplex unit of Block A, B, C, D, E or F (as the case may be). e.g. "G1" refers to Garden Duplex 1 of Block A, B, C, D, E or F (as the case may be).
2. In the description of residential property in a residential block, the prefix "P" means Penthouse Triplex unit and the numbering means the numbering of Penthouse Triplex unit of Block A, B, D, E or F (as the case may be). e.g. "P1" refers to Penthouse Triplex 1 of Block A, B, D, E or F (as the case may be).
3. In the description of residential property in a residential block, the prefix "P" means Penthouse Duplex unit and the numbering means the numbering of Penthouse Duplex unit of Block C. e.g. "P1" refers to Penthouse Duplex 1 of Block C.

備註:

1. 住宅大樓的住宅物業的描述中，字首「G」指花園複式單位，而編號指A、B、C、D、E或F座(視情況而定)的花園複式單位的編號。例如「G1」指A、B、C、D、E或F座(視情況而定)的花園複式1號單位。
2. 住宅大樓中住宅物業的描述中，字首「P」指頂層三複式單位，而編號指A、B、D、E或F座(視情況而定)的頂層三複式單位的編號。例如「P1」指A、B、D、E或F座(視情況而定)的頂層三複式1號單位。
3. 住宅大樓中住宅物業的描述中，字首「P」指頂層複式單位，而編號指C座的頂層複式單位的編號。例如「P1」指C座的頂層複式1號單位。

Fittings, finishes and appliances

裝置、裝修物料及設備

5. Security facilities
Description
<ul style="list-style-type: none"> - CCTV cameras are provided at landscape area, main entrance lobby of residential tower and residential block, lift lobby and lift cars of residential tower and residential block and carpark area. - Visitor intercom panel and smart card reader is provided at development main entrance and main entrance of residential tower and residential block, and connected to door phone of each residential property; smart card reader is provided at carpark entrance. - Each residential property is equipped with a handset type door phone with panic alarm push button. - The private lift lobby of each of the following residential properties is equipped with an intercom system connected to the main security room: Flat A, G/F to 7/F, Tower I Residential Unit P1 and P3, 1/F, to 2/F, Block A and B Residential Unit G1 to G3 and G5 to G7, LG/F, Block E Residential Unit G1 to G3 and G5, LG/F, Block F - Perimeter intrusion detection system is provided at part of the site boundary. - Infrared sensor, CCTV camera and flash light are provided for residential property with garden on G/F.

6. Appliances
Description
<ul style="list-style-type: none"> - As set out in the "Appliances Schedule".

5. 保安設施
描述
<ul style="list-style-type: none"> - 園景區、住宅大廈及住宅大樓入口大堂、住宅大廈及住宅大樓升降機大堂及升降機及停車場均裝設有閉路電視。 - 訪客對講系統及智能卡出入系統裝設於屋苑主入口及住宅大廈及住宅大樓入口，並連接該大廈各住宅物業內之對講機；智能卡出入系統亦裝設於停車場車輛入口。 - 每個住宅物業均配備手提式對講機連警鐘按鈕。 - 以下住宅物業之私人升降機大堂設有對講機系統連接保安控制室： 1座地下至7樓A單位 A及B座1樓至2樓住宅單位P1及P3 E座地下低層住宅單位G1至G3及G5至G7 F座地下低層住宅單位G1至G3及G5 - 屋苑部分邊界裝有週界入侵檢測系統。 - 地下住宅物業花園設有紅外線感應器，閉路電視及閃燈。

6. 設備
描述
<ul style="list-style-type: none"> - 於「設備說明表」列出。

The vendor undertakes that if lifts or appliances of the specified brand name or model number are not installed in the Development, lifts or appliances of comparable quality will be installed.

賣方承諾如發展項目中沒有安裝指明的品牌名稱或產品型號的升降機或設備，便會安裝品質相若的升降機或設備。

Remarks:

1. In the description of residential property in a residential block, the prefix "G" means Garden Duplex unit and the numbering means the numbering of Garden Duplex unit of Block A, B, C, D, E or F (as the case may be). e.g. "G1" refers to Garden Duplex 1 of Block A, B, C, D, E or F (as the case may be).
2. In the description of residential property in a residential block, the prefix "P" means Penthouse Triplex unit and the numbering means the numbering of Penthouse Triplex unit of Block A, B, D, E or F (as the case may be). e.g. "P1" refers to Penthouse Triplex 1 of Block A, B, D, E or F (as the case may be).
3. In the description of residential property in a residential block the prefix "P" means Penthouse Duplex unit and the numbering means the numbering of Penthouse Duplex unit of Block C. e.g. "P1" refers to Penthouse Duplex 1 of Block C.

備註:

1. 住宅大樓的住宅物業的描述中，字首「G」指花園複式單位，而編號指A、B、C、D、E或F座(視情況而定)的花園複式單位的編號。例如「G1」指A、B、C、D、E或F座(視情況而定)的花園複式1號單位。
2. 住宅大樓中住宅物業的描述中，字首「P」指頂層三複式單位，而編號指A、B、D、E或F座(視情況而定)的頂層三複式單位的編號。例如「P1」指A、B、D、E或F座(視情況而定)的頂層三複式1號單位。
3. 住宅大樓中住宅物業的描述中，字首「P」指頂層複式單位，而編號指C座的頂層複式單位的編號。例如「P1」指C座的頂層複式1號單位。