

65 - 89 Tan Kwai Tsuen Road
丹桂村路65 - 89號

Sales Brochure
售樓說明書

You are advised to take the following steps before purchasing first-hand residential properties.

For all first-hand residential properties

1. Important information

- Make reference to the materials available on the Sales of First-hand Residential Properties Electronic Platform (SRPE) (www.srpe.gov.hk) on the first-hand residential property market.
- Study the information on the website designated by the vendor for the development, including the sales brochure, price lists, documents containing the sales arrangements, and the register of transactions of a development.
- Sales brochure for a development will be made available to the general public at least 7 days immediately before a date of sale while price list and sales arrangements will be made available at least 3 days immediately before the date of sale.
- Information on transactions can be found on the register of transactions on the website designated by the vendor for the development and the SRPE.

2. Fees, mortgage loan and property price

- Calculate the total expenses of the purchase, such as solicitors' fees, mortgage charges, insurance fees and stamp duties.
- Check with banks to find out if you will be able to obtain the needed mortgage loan, select the appropriate payment method and calculate the amount of the mortgage loan to ensure it is within your repayment ability.
- Check recent transaction prices of comparable properties for comparison.
- Check with the vendor or the estate agent the estimated management fee, the amount of management fee payable in advance (if any), special fund payable (if any), the amount of reimbursement of the deposits for water, electricity and gas (if any), and/or the amount of debris removal fee (if any) you have to pay to the vendor or the manager of the development.

3. Price list, payment terms and other financial incentives

- Vendors may not offer to sell all the residential properties that are covered in a price list. To know which residential properties the vendors may offer to sell, pay attention to the sales arrangements which will be announced by the vendors at least 3 days before the relevant residential properties are offered to be sold.
- Pay attention to the terms of payment as set out in a price list. If there are discounts on the price, gift, or any financial advantage or benefit to be made available in connection with the purchase of the residential properties, such information will also be set out in the price list.
- If you intend to opt for any mortgage loan plans offered by financial institutions specified by the vendor, before entering into a preliminary agreement for sale and purchase (PASP), you must study the details of various mortgage loan plans¹ as set out in the price list concerned. If you have any questions about these mortgage loan plans, you should check with the financial institutions concerned direct before entering into a PASP.

4. Property area and its surroundings

- Pay attention to the area information in the sales brochure and price list, and price per square foot/metre in the price list. According to the Residential Properties (First-hand Sales) Ordinance (Cap. 621) (the Ordinance), vendors can only present the area and price per square foot and per square metre of a residential property using saleable area. Saleable area, in relation to a residential property, means the floor area of the residential property, and includes the floor area of every one of the following to the extent that it forms part of the residential property - (i) a balcony; (ii) a utility platform; and (iii) a verandah. The saleable area excludes the area of the following which forms part of the residential property - air-conditioning plant room; bay window; cockloft; flat roof; garden; parking space; roof; stairhood; terrace and yard.
- Floor plans of all residential properties in the development have to be shown in the sales brochure. In a sales brochure, floor plans of residential properties in the development must state the external and internal dimensions of each residential property². The external and internal dimensions of residential properties as provided in the sales brochure exclude plaster and finishes. You are advised to note this if you want to buy furniture before handing over of the residential property.
- Visit the development site and get to know the surroundings of the property (including transportation and community facilities). Check town planning proposals and decisions which may affect the property. Take a look at the location plan, aerial photograph, outline zoning plan and cross-section plan that are provided in the sales brochure.

5. Sales brochure

- Ensure that the sales brochure you have obtained is the latest version. According to the Ordinance, the sales brochure made available to the public should be printed or examined, or examined and revised within the previous 3 months.
- Read through the sales brochure and in particular, check the following information in the sales brochure -
 - whether there is a section on “relevant information” in the sales brochure, under which information on any matter that is known to the vendor but is not known to the general public, and is likely to materially affect the enjoyment of a residential property will be set out. Please note that information contained in a document that has been registered with the Land Registry will not be regarded as “relevant information”;
 - the cross-section plan showing a cross-section of the building in relation to every street adjacent to the building, and the level of every such street in relation to a known datum and to the level of the lowest residential floor of the building. This will help you visualize the difference in height between the lowest residential floor of a building and the street level, regardless of how that lowest residential floor is named;
 - interior and exterior fittings and finishes and appliances;
 - the basis on which management fees are shared;
 - whether individual owners have obligations or need to share the expenses for managing, operating and maintaining the public open space or public facilities inside or outside the development, and the location of the public open space or public facilities; and
 - whether individual owners have responsibility to maintain slopes.

6. Government land grant and deed of mutual covenant (DMC)

- Read the Government land grant and the DMC (or the draft DMC). Information such as ownership of the rooftop and external walls can be found in the DMC. The vendor will provide copies of the Government land grant and the DMC (or the draft DMC) at the place where the sale is to take place for free inspection by prospective purchasers.
- Check the Government land grant on whether individual owners are liable to pay Government rent.
- Check the DMC on whether animals can be kept in the residential property.

7. Information on Availability of Residential Properties for Selection at Sales Office

- Check with the vendor which residential properties are available for selection. If a “consumption table” is displayed by the vendor at the sales office, you may check from the table information on the progress of sale on a date of sale, including which residential properties are offered for sale at the beginning of that date of sale and which of them have been selected and sold during that date of sale.
- Do not believe in rumours about the sales condition of the development and enter into a PASP rashly.

8. Register of Transactions

- Pay attention to the register of transactions for a development. A vendor must, within 24 hours after entering into a PASP with a purchaser, enter transaction information of the PASP in the register of transactions. The vendor must, within 1 working day after entering into an agreement for sale and purchase (ASP), enter transaction information of the ASP in the register of transactions. Check the register of transactions for the concerned development to learn more about the sales condition of the development.
- Never take the number of registrations of intent or cashier orders a vendor has received for the purpose of registration as an indicator of the sales volume of a development. The register of transactions for a development is the most reliable source of information from which members of the public can grasp the daily sales condition of the development.

¹ The details of various mortgage loan plans include the requirements for mortgagors on minimum income level, the loan limit under the first mortgage and second mortgage, the maximum loan repayment period, the change of mortgage interest rate throughout the entire repayment period, and the payment of administrative fees.

² According to section 10(2)(d) in Part 1 of Schedule 1 to the Ordinance, each of the floor plans of the residential properties in the development in the sales brochure must state the following -
(i) the external dimensions of each residential property;
(ii) the internal dimensions of each residential property;
(iii) the thickness of the internal partitions of each residential property;
(iv) the external dimensions of individual compartments in each residential property.

According to section 10(3) in Part 1 of Schedule 1 to the Ordinance, if any information required by section 10(2)(d) in Part 1 of Schedule 1 to the Ordinance is provided in the approved building plans for the development, a floor plan must state the information as so provided.

9. Agreement for sale and purchase

- Ensure that the PASP and ASP include the mandatory provisions as required by the Ordinance.
- Pay attention that fittings, finishes and appliances to be included in the sale and purchase of the property are inserted in the PASP and ASP.
- Pay attention to the area plan annexed to the ASP which shows the total area which the vendor is selling to you. The total area which the vendor is selling to you is normally greater than the saleable area of the property.
- A preliminary deposit of 5% of the purchase price is payable by you to the owner (i.e. the seller) on entering into a PASP.
- If you do not execute the ASP within 5 working days (working day means a day that is not a general holiday or a Saturday or a black rainstorm warning day or gale warning day) after entering into the PASP, the PASP is terminated, the preliminary deposit (i.e. 5% of the purchase price) is forfeited, and the owner (i.e. the seller) does not have any further claim against you for not executing the ASP.
- If you execute the ASP within 5 working days after the signing of the PASP, the owner (i.e. the seller) must execute the ASP within 8 working days after entering into the PASP.
- The deposit should be made payable to the solicitors' firm responsible for stakeholding purchasers' payments for the property.

10. Expression of intent of purchasing a residential property

- Note that vendors (including their authorized representative(s)) should not seek or accept any specific or general expression of intent of purchasing any residential property before the relevant price lists for such properties are made available to the public. You therefore should not make such an offer to the vendors or their authorized representative(s).
- Note that vendors (including their authorized representative(s)) should not seek or accept any specific expression of intent of purchasing a particular residential property before the sale of the property has commenced. You therefore should not make such an offer to the vendors or their authorized representative(s).

11. Appointment of estate agent

- Note that if the vendor has appointed one or more than one estate agents to act in the sale of any specified residential property in the development, the price list for the development must set out the name of all the estate agents so appointed as at the date of printing of the price list.
- You may appoint any estate agent (not necessarily from those estate agency companies appointed by the vendor) to act in the purchase of any specified residential property in the development, and may also not appoint any estate agent to act on your behalf.
- Before you appoint an estate agent to look for a property, you should -
 - find out whether the agent will act on your behalf only. If the agent also acts for the vendor, he/she may not be able to protect your best interests in the event of a conflict of interest;
 - find out whether any commission is payable by you to the estate agent and, if so, its amount and the time of payment; and
 - note that only licensed estate agents or salespersons may accept your appointment. If in doubt, you should request the estate agent or salesperson to produce his/her Estate Agent Card, or check the Licence List on the Estate Agents Authority website: www.eaa.org.hk.

12. Appointment of solicitor

- Consider appointing your own solicitor to protect your interests. If the solicitor also acts for the vendor, he/she may not be able to protect your best interests in the event of a conflict of interest.
- Compare the charges of different solicitors.

For first-hand uncompleted residential properties

13. Pre-sale Consent

- For uncompleted residential property under the Lands Department Consent Scheme, seek confirmation from the vendor whether the "Pre-sale Consent" has been issued by the Lands Department for the development.

14. Show flats

- While the vendor is not required to make any show flat available for viewing by prospective purchasers or the general public, if the vendor wishes to make available show flats of a specified residential property, the vendor must first of all make available an unmodified show flat of that residential property and that, having made available such unmodified show flat, the vendor may then make available a modified show flat of that residential property.

In this connection, the vendor is allowed to make available more than one modified show flat of that residential property.

- If you visit the show flats, you should always look at the unmodified show flats for comparison with the modified show flats. That said, the Ordinance does not restrict the discretion of the vendor in arranging the sequence of the viewing of unmodified and modified show flats.
- Sales brochure of the development should have been made available to the public when the show flat is made available for viewing. You are advised to get a copy of the sales brochure and make reference to it when viewing the show flats.
- You may take measurements in modified and unmodified show flats, and take photographs or make video recordings of unmodified show flats, subject to reasonable restriction(s) which may be set by the vendor for ensuring safety of the persons viewing the show flat.

For first-hand uncompleted residential properties and completed residential properties pending compliance

15. Estimated material date and handing over date

- Check the estimated material date³ for the development in the sales brochure.
 - The estimated material date for a development in the sales brochure is not the same as the date on which a residential property is handed over to purchaser. The latter is inevitably later than the former.
- Handing over date
 - The mandatory provisions to be incorporated in an ASP as required by the Ordinance include a provision requiring the vendor to apply in writing for an Occupation Document/a Certificate of Compliance or the Director of Lands' Consent to Assign (as the case may be) in respect of the development within 14 days after the estimated material date as stipulated in the ASP.
 - For development subject to the Lands Department Consent Scheme, the vendor is required to notify the purchaser in writing that the vendor is in a position validly to assign the property within one month after the issue of the Certificate of Compliance or the Consent to Assign, whichever first happens; or
 - For development not subject to the Lands Department Consent Scheme, the vendor is required to notify the purchaser in writing that the vendor is in a position validly to assign the property within 6 months after the issue of the Occupation Document including Occupation Permit.
 - The mandatory provisions to be incorporated in an ASP as required by the Ordinance include a provision requiring completion of the sale and purchase within 14 days after the date of the notification aforesaid. Upon completion, the vendor shall arrange handover of the property to the purchaser.
- Authorized Person (AP) may grant extension(s) of time for completion of the development beyond the estimated material date.
 - The mandatory provisions to be incorporated in an ASP as required by the Ordinance include a provision that the AP of a development may grant an extension of time for completion of the development beyond the estimated material date having regard to delays caused exclusively by any one or more of the following reasons:
 - strike or lock-out of workmen;
 - riots or civil commotion;
 - force majeure or Act of God;
 - fire or other accident beyond the vendor's control;
 - war; or
 - inclement weather.
 - The AP may grant more than once such an extension of time depending on the circumstances. That means handover of the property may be delayed.
 - The mandatory provisions to be incorporated in an ASP as required by the Ordinance also include a provision requiring the vendor to, within 14 days after the issue of an extension of time granted by the AP, furnish the purchaser with a copy of the relevant certificate of extension.
- Ask the vendor if there are any questions on handing over date.

³ Generally speaking, "material date" means the date on which the conditions of the land grant are complied with in respect of the development, or the date on which the development is completed in all respects in compliance with the approved building plans or the conditions subject to which the certificate of exemption is issued. For details, please refer to section 2 of the Ordinance.

NOTES TO PURCHASERS OF FIRST-HAND RESIDENTIAL PROPERTIES 一手住宅物業買家須知

For first-hand completed residential properties

16. Vendor's information form

- Ensure that you obtain the “vendor’s information form(s)” printed within the previous 3 months in relation to the residential property/properties you intend to purchase.

17. Viewing of property

- Ensure that, before you purchase a residential property, you are arranged to view the residential property that you would like to purchase or, if it is not reasonably practicable to view the property in question, a comparable property in the development, unless you agree in writing that the vendor is not required to arrange such a comparable property for viewing for you. You are advised to think carefully before signing any waiver.
- You may take measurements, take photographs or make video recordings of the property, unless the property is held under a tenancy or reasonable restriction(s) is/are needed to ensure safety of the persons viewing the property.

For complaints and enquiries relating to the sales of first-hand residential properties by the vendors which the Ordinance applies, please contact the Sales of First-hand Residential Properties Authority -

Website	: www.srpa.gov.hk
Telephone	: 2817 3313
Email	: enquiry_srpa@hd.gov.hk
Fax	: 2219 2220

Other useful contacts:

Consumer Council	
Website	: www.consumer.org.hk
Telephone	: 2929 2222
Email	: cc@consumer.org.hk
Fax	: 2856 3611

Estate Agents Authority	
Website	: www.eaa.org.hk
Telephone	: 2111 2777
Email	: enquiry@eaa.org.hk
Fax	: 2598 9596

Real Estate Developers Association of Hong Kong	
Telephone	: 2826 0111
Fax	: 2845 2521

Sales of First-hand Residential Properties Authority
Transport and Housing Bureau
August 2017

您在購置一手住物業之前，應留意下列事項：

適用於所有一手住宅物業

1. 重要資訊

- 瀏覽一手住宅物業銷售資訊網（下稱「銷售資訊網」）（網址：www.srpe.gov.hk），參考「銷售資訊網」內有關一手住宅物業的市場資料。
- 閱覽賣方就該發展項目所指定的互聯網網站內的有關資訊，包括售樓說明書、價單、載有銷售安排的文件，及成交紀錄冊。
- 發展項目的售樓說明書，會在該項目的出售日期前最少七日向公眾發布，而有關價單和銷售安排，亦會在該項目的出售日期前最少三日公布。
- 在賣方就有關發展項目所指定的互聯網網站，以及「銷售資訊網」內，均載有有關物業成交資料的成交紀錄冊，以供查閱。

2. 費用、按揭貸款和樓價

- 計算置業總開支，包括律師費、按揭費用、保險費，以及印花稅。
- 向銀行查詢可否取得所需的按揭貸款，然後選擇合適的還款方式，並小心計算按揭貸款金額，以確保貸款額沒有超出本身的負擔能力。
- 查閱同類物業最近的成交價格，以作比較。
- 向賣方或地產代理瞭解，您須付予賣方或該發展項目的管理人的預計的管理費、管理費上期金額（如有）、特別基金金額（如有）、補還的水、電力及氣體按金（如有）、以及／或清理廢料的費用（如有）。

3. 價單、支付條款，以及其他財務優惠

- 賣方未必會把價單所涵蓋的住宅物業悉數推售，因此應留意有關的銷售安排，以了解賣方會推售的住宅物業為何。賣方會在有關住宅物業推售日期前最少三日公布銷售安排。
- 留意價單所載列的支付條款。倘買家可就購置有關住宅物業而連帶獲得價格折扣、贈品，或任何財務優惠或利益，上述資訊亦會在價單內列明。
- 如您擬選用由賣方指定的財務機構提供的各類按揭貸款計劃，在簽訂臨時買賣合約前，應先細閱有關價單內列出的按揭貸款計劃資料¹。如就該些按揭貸款計劃的詳情有任何疑問，應在簽訂臨時買賣合約前，直接向有關財務機構查詢。

4. 物業的面積及四周環境

- 留意載於售樓說明書和價單內的物業面積資料，以及載於價單內的每平方呎／每平方米售價。根據《一手住宅物業銷售條例》（第621章）（下稱「條例」），賣方只可以實用面積表達住宅物業的面積和每平方呎及平方米的售價。就住宅物業而言，實用面積指該住宅物業的樓面面積，包括在構成該物業的一部分的範圍內的以下每一項目的樓面面積：(i) 露台；(ii) 工作平台；以及 (iii) 陽台。實用面積並不包括空調機房、窗台、閣樓、平台、花園、停車位、天台、梯屋、前庭或庭院的每一項目的面積，即使該些項目構成該物業的一部分的範圍。
- 售樓說明書必須顯示發展項目中所有住宅物業的樓面平面圖。在售樓說明書所載有關發展項目中住宅物業的每一份樓面平面圖，均須述明每個住宅物業的外部及內部尺寸²。售樓說明書所提供有關住宅物業外部及內部的尺寸，不會把批盪和裝飾物料包括在內。買家收樓前如欲購置家具，應留意這點。
- 親臨發展項目的所在地實地視察，以了解有關物業的四周環境（包括交通和社區設施）；亦應查詢有否任何城市規劃方案和議決，會對有關的物業造成影響；參閱載於售樓說明書內的位置圖、鳥瞰照片、分區計劃大綱圖，以及橫截面圖。

5. 售樓說明書

- 確保所取得的售樓說明書屬最新版本。根據條例，提供予公眾的售樓說明書必須是在之前的三個月之內印製或檢視、或檢視及修改。
- 閱覽售樓說明書，並須特別留意以下資訊：
 - 售樓說明書內有否關於「有關資料」的部分，列出賣方知悉但並非為一般公眾人士所知悉，關於相當可能對享有有關住宅物業造成重大影響的事宜的資料。請注意，已在土地註冊處註冊的文件，其內容不會被視為「有關資料」；
 - 橫截面圖會顯示有關建築物相對毗連該建築物的每條街道的橫截面，以及每條上述街道與已知基準面和該建築物最低的一層住宅樓層的水平相對的水平。橫截面圖能以圖解形式，顯示出建築物最低一層住宅樓層和街道水平的高低差距，不論該最低住宅樓層以何種方式命名；
 - 室內和外部的裝置、裝修物料和設備；
 - 管理費按甚麼基準分擔；
 - 小業主有否責任或需要分擔管理、營運或維持有關發展項目以內或以外的公眾休憩用地或公共設施

- 的開支，以及有關公眾休憩用地或公共設施的位置；以及
- 小業主是否須要負責維修斜坡。

6. 政府批地文件和公契

- 閱覽政府批地文件和公契（或公契擬稿）。公契內載有天台和外牆業權等相關資料。賣方會在售樓處提供政府批地文件和公契（或公契擬稿）的複本，供準買家免費閱覽。
- 留意政府批地文件內所訂明小業主是否須要負責支付地稅。
- 留意公契內訂明有關物業內可否飼養動物。

7. 售樓處內有關可供揀選住宅物業的資料

- 向賣方查詢清楚有哪些一手住宅物業可供揀選。若賣方在售樓處內展示「消耗表」，您可從該「消耗表」得悉在每個銷售日的銷售進度資料，包括在該個銷售日開始時有哪些住宅物業可供出售，以及在該個銷售日內有哪些住宅物業已獲揀選及售出。
- 切勿隨便相信有關發展項目銷情的傳言，倉卒簽立臨時買賣合約。

8. 成交紀錄冊

- 留意發展項目的成交紀錄冊。賣方須於臨時買賣合約訂立後的24小時內，於紀錄冊披露該臨時買賣合約的資料，以及於買賣合約訂立後一個工作天內，披露該買賣合約的資料。您可透過成交紀錄冊得悉發展項目的銷售情況。
- 切勿將賣方接獲用作登記的購樓意向書或本票的數目視為銷情指標。發展項目的成交紀錄冊才是讓公眾掌握發展項目每日銷售情況的最可靠資料來源。

9. 買賣合約

- 確保臨時買賣合約和買賣合約包含條例所規定的強制性條文。
- 留意有關物業買賣交易所包括的裝置、裝修物料和設備，須在臨時買賣合約和買賣合約上列明。
- 留意夾附於買賣合約的圖則。該圖則會顯示所有賣方售予您的物業面積，而該面積通常較該物業的實用面積為大。
- 訂立臨時買賣合約時，您須向擁有人（即賣方）支付樓價5%的臨時訂金。
- 如您在訂立臨時買賣合約後五個工作日（工作日指並非公眾假日、星期六、黑色暴雨警告日或烈風警告日的日子）之內，沒有簽立買賣合約，該臨時買賣合約即告終止，有關臨時訂金（即樓價的5%）會被沒收，而擁有人（即賣方）不得因您沒有簽立買賣合約而對您提出進一步申索。
- 在訂立臨時買賣合約後的五個工作日之內，倘您簽立買賣合約，則擁有人（即賣方）必須在訂立該臨時買賣合約後的八個工作日之內簽立買賣合約。
- 有關的訂金，應付予負責為所涉物業擔任保證金保存人的律師事務所。

10. 表達購樓意向

- 留意在賣方（包括其獲授權代表）就有關住宅物業向公眾提供價單前，賣方不得尋求或接納任何對有關住宅物業的購樓意向（不論是否屬明確選擇購樓意向）。因此您不應向賣方或其授權代表提出有關意向。
- 留意在有關住宅物業的銷售開始前，賣方（包括其獲授權代表）不得尋求或接納任何對該物業的有明確選擇購樓意向。因此您不應向賣方或其授權代表提出有關意向。

¹ 按揭貸款計劃的資料包括有關按揭貸款計劃對借款人的最低收入的要求、就第一按揭連同第二按揭可獲得的按揭貸款金額上限、最長還款年期、整個還款期內的按揭利率變化，以及申請人須繳付的手續費。

² 根據條例附表1第1部第10(2)(d)條述明，售樓說明書內顯示的發展項目中的住宅物業的每一份樓面平面圖須述明以下各項—

- (i) 每個住宅物業的外部尺寸；
- (ii) 每個住宅物業的內部尺寸；
- (iii) 每個住宅物業的內部間隔的厚度；
- (iv) 每個住宅物業內個別分隔室的外部尺寸。

根據條例附表1第1部第10(3)條，如有關發展項目的經批准的建築圖則，提供條例附表1第1部第10(2)(d)條所規定的資料，樓面平面圖須述明如此規定的該資料。

11. 委託地產代理

- 留意倘賣方委任一個或多於一個地產代理，以協助銷售其發展項目內任何指明住宅物業，該發展項目的價單必須列明在價單印刷日期當日所有獲委任為地產代理的姓名／名稱。
- 您可委託任何地產代理（不一定是賣方所指定的地產代理），以協助您購置發展項目內任何指明住宅物業；您亦可不委託任何地產代理。
- 委託地產代理以物色物業前，您應該—
 - 了解該地產代理是否只代表您行事。該地產代理若同時代表賣方行事，倘發生利益衝突，未必能夠保障您的最大利益；
 - 了解您須否支付佣金予該地產代理。若須支付，有關的佣金金額和支付日期為何；以及
 - 留意只有持牌地產代理或營業員才可以接受您的委託。如有疑問，應要求該地產代理或營業員出示其「地產代理證」，或瀏覽地產代理監管局的網頁（網址：www.eaa.org.hk），查閱牌照目錄。

12. 委聘律師

- 考慮自行委聘律師，以保障您的利益。該律師若同時代表賣方行事，倘發生利益衝突，未必能夠保障您的最大利益。
- 比較不同律師的收費。

適用於一手未落成住宅物業

13. 預售樓花同意書

- 洽購地政總署「預售樓花同意方案」下的未落成住宅物業時，應向賣方確認地政總署是否已就該發展項目批出「預售樓花同意書」。

14. 示範單位

- 賣方不一定須設置示範單位供準買家或公眾參觀，但賣方如為某指明住宅物業設置示範單位，必須首先設置該住宅物業的無改動示範單位，才可設置該住宅物業的經改動示範單位，並可以就該住宅物業設置多於一個經改動示範單位。
- 參觀示範單位時，務必視察無改動示範單位，以便與經改動示範單位作出比較。然而，條例並沒有限制賣方安排參觀無改動示範單位及經改動示範單位的先後次序。
- 賣方設置示範單位供公眾參觀時，應已提供有關發展項目的售樓說明書。因此，緊記先行索取售樓說明書，以便在參觀示範單位時參閱相關資料。
- 您可以在無改動示範單位及經改動示範單位中進行量度，並在無改動示範單位內拍照或拍攝影片，惟在確保示範單位參觀者人身安全的前提下，賣方可能會設定合理的限制。

適用於一手未落成住宅物業及尚待符合條件的已落成住宅物業

15. 預計關鍵日期及收樓日期

- 查閱售樓說明書中有關發展項目的預計關鍵日期³。
 - 售樓說明書中有關發展項目的預計關鍵日期並不同買家的「收樓日期」。買家的「收樓日期」必定較發展項目的預計關鍵日期遲。
- 收樓日期
 - 條例規定買賣合約須載有強制性條文，列明賣方須於買賣合約內列出的預計關鍵日期後的14日內，以書面為發展項目申請佔用文件、合格證明書，或地政總署署長的轉讓同意（視屬何種情況而定）。
 - 如發展項目屬地政總署預售樓花同意方案所規管，賣方須在合格證明書或地政總署署長的轉讓同意發出後的一個月內（以較早者為準），就賣方有能力有效地轉讓有關物業一事，以書面通知買家；或
 - 如發展項目並非屬地政總署預售樓花同意方案所規管，賣方須在佔用文件（包括佔用許可證）發出後的六個月內，就賣方有能力有效地轉讓有關物業一事，以書面通知買家。
 - 條例規定買賣合約須載有強制性條文，列明有關物業的買賣須於賣方發出上述通知的日期的14日內完成。有關物業的買賣完成後，賣方將安排買家收樓事宜。
- 認可人士可批予在預計關鍵日期之後完成發展項目
 - 條例規定買賣合約須載有強制性條文，列明發展項目的認可人士可以在顧及純粹由以下一個或多於一個原因所導致的延遲後，批予在預計關鍵日期之後，完成發展項目：
 - 工人罷工或封閉工地；
 - 暴動或內亂；
 - 不可抗力或天災；

- 火警或其他賣方所不能控制的意外；
- 戰爭；或
- 惡劣天氣。

- 發展項目的認可人士可以按情況，多於一次批予延後預計關鍵日期以完成發展項目，即收樓日期可能延遲。
 - 條例規定買賣合約須載有強制性條文，列明賣方須於認可人士批予延期後的14日內，向買家提供有關延期證明書的文本。
- 如對收樓日期有任何疑問，可向賣方查詢。

適用於一手已落成住宅物業

16. 賣方資料表格

- 確保取得最近三個月內印製有關您擬購買的一手已落成住宅物業的「賣方資料表格」。

17. 參觀物業

- 購置住宅物業前，確保已獲安排參觀您打算購置的住宅物業。倘參觀有關物業並非合理地切實可行，則應參觀與有關物業相若的物業，除非您以書面同意賣方無須開放與有關物業相若的物業供您參觀。您應仔細考慮，然後才決定是否簽署豁免上述規定的書面同意。
- 除非有關物業根據租約持有，或為確保物業參觀者的人身安全而須設定合理限制，您可以對該物業進行量度、拍照或拍攝影片。

³ 一般而言，「關鍵日期」指該項目符合批地文件的條件的日期，或該項目在遵照經批准的建築圖則的情況下或按照豁免證明書的發出的條件在各方面均屬完成的日期。有關詳情請參閱條例第2條。

任何與賣方銷售受條例所規管的一手住宅物業有關的投訴和查詢，請與一手住宅物業銷售監管局聯絡。

網址	: www.srpa.gov.hk
電話	: 2817 3313
電郵	: enquiry_srpa@hd.gov.hk
傳真	: 2219 2220

其他相關聯絡資料：

消費者委員會	
網址	: www.consumer.org.hk
電話	: 2929 2222
電郵	: cc@consumer.org.hk
傳真	: 2856 3611

地產代理監管局	
網址	: www.eaa.org.hk
電話	: 2111 2777
電郵	: enquiry@eaa.org.hk
傳真	: 2598 9596

香港地產建設商會	
電話	: 2826 0111
傳真	: 2845 2521

運輸及房屋局
一手住宅物業銷售監管局
2017年8月

INFORMATION ON THE DEVELOPMENT 發展項目的資料

Name of the Development

65-89 Tan Kwai Tsuen Road

Name of the street and street number

65, 67A, 67B, 69A, 69B, 71A, 71B, 73A, 73B, 75A, 75B, 77A, 77B, 79A - 79F, 81, 83A - 83G, 85A - 85D, 87A - 87E and 89 Tan Kwai Tsuen Road

The Development consists of a mutli-unit building known as “DOMUS” and 36 houses known as “Casa Regalia”

Total number of storeys of DOMUS

4 storeys (G/F to 3/F, excluding the Roof)

Floor numbering of DOMUS

G/F, 1/F, 2/F and 3/F

Omitted floor numbers of DOMUS

No omitted floor number

Refuge floor of DOMUS

No refuge floor

Total number of houses in Casa Regalia

36

House Number	House Name
House 1	67A Tan Kwai Tsuen Road, Casa Regalia
House 2	83A Tan Kwai Tsuen Road, Casa Regalia
House 3	67B Tan Kwai Tsuen Road, Casa Regalia
House 5	69A Tan Kwai Tsuen Road, Casa Regalia
House 6	83B Tan Kwai Tsuen Road, Casa Regalia
House 7	69B Tan Kwai Tsuen Road, Casa Regalia
House 8	83C Tan Kwai Tsuen Road, Casa Regalia
House 9	71A Tan Kwai Tsuen Road, Casa Regalia
House 10	83D Tan Kwai Tsuen Road, Casa Regalia
House 11	71B Tan Kwai Tsuen Road, Casa Regalia
House 12	83E Tan Kwai Tsuen Road, Casa Regalia
House 15	73A Tan Kwai Tsuen Road, Casa Regalia
House 16	83F Tan Kwai Tsuen Road, Casa Regalia
House 17	73B Tan Kwai Tsuen Road, Casa Regalia
House 18	83G Tan Kwai Tsuen Road, Casa Regalia
House 19	75A Tan Kwai Tsuen Road, Casa Regalia
House 20	85A Tan Kwai Tsuen Road, Casa Regalia
House 21	75B Tan Kwai Tsuen Road, Casa Regalia
House 22	85B Tan Kwai Tsuen Road, Casa Regalia
House 23	77A Tan Kwai Tsuen Road, Casa Regalia
House 25	77B Tan Kwai Tsuen Road, Casa Regalia
House 26	85C Tan Kwai Tsuen Road, Casa Regalia
House 27	79A Tan Kwai Tsuen Road, Casa Regalia
House 28	85D Tan Kwai Tsuen Road, Casa Regalia
House 29	79B Tan Kwai Tsuen Road, Casa Regalia
House 30	87A Tan Kwai Tsuen Road, Casa Regalia

發展項目名稱

丹桂村路 65-89 號

街道名稱及門牌號數

丹桂村路 65、67A、67B、69A、69B、71A、71B、73A、73B、75A、75B、77A、77B、79A-79F、81、83A-83G、85A-85D、87A-87E 及 89 號

發展項目包含1幢名為「尚築」的多單位建築物及36座名為「富豪·悦庭」的洋房

尚築的樓層總數

4層（地下至三樓，不包括天台）

尚築的樓層號數

地下、1樓、2樓及3樓

尚築內被略去的樓層號數

沒有被略去的樓層號數

尚築內的庇護層

不設庇護層

富豪·悦庭的洋房總數

共36座

洋房號碼

洋房 1

洋房 2

洋房 3

洋房 5

洋房 6

洋房 7

洋房 8

洋房 9

洋房 10

洋房 11

洋房 12

洋房 15

洋房 16

洋房 17

洋房 18

洋房 19

洋房 20

洋房 21

洋房 22

洋房 23

洋房 25

洋房 26

洋房 27

洋房 28

洋房 29

洋房 30

洋房名稱

富豪·悦庭丹桂村路67A號

富豪·悦庭丹桂村路83A號

富豪·悦庭丹桂村路67B號

富豪·悦庭丹桂村路69A號

富豪·悦庭丹桂村路83B號

富豪·悦庭丹桂村路69B號

富豪·悦庭丹桂村路83C號

富豪·悦庭丹桂村路71A號

富豪·悦庭丹桂村路83D號

富豪·悦庭丹桂村路71B號

富豪·悦庭丹桂村路83E號

富豪·悦庭丹桂村路73A號

富豪·悦庭丹桂村路83F號

富豪·悦庭丹桂村路73B號

富豪·悦庭丹桂村路83G號

富豪·悦庭丹桂村路75A號

富豪·悦庭丹桂村路85A號

富豪·悦庭丹桂村路75B號

富豪·悦庭丹桂村路85B號

富豪·悦庭丹桂村路77A號

富豪·悦庭丹桂村路77B號

富豪·悦庭丹桂村路85C號

富豪·悦庭丹桂村路79A號

富豪·悦庭丹桂村路85D號

富豪·悦庭丹桂村路79B號

富豪·悦庭丹桂村路87A號

House Number	House Name
House 31	79C Tan Kwai Tsuen Road, Casa Regalia
House 32	87B Tan Kwai Tsuen Road, Casa Regalia
House 33	79D Tan Kwai Tsuen Road, Casa Regalia
House 35	79E Tan Kwai Tsuen Road, Casa Regalia
House 36	87C Tan Kwai Tsuen Road, Casa Regalia
House 37	79F Tan Kwai Tsuen Road, Casa Regalia
House 38	87D Tan Kwai Tsuen Road, Casa Regalia
House 39	81 Tan Kwai Tsuen Road, Casa Regalia
House 50	87E Tan Kwai Tsuen Road, Casa Regalia
House 52	89 Tan Kwai Tsuen Road, Casa Regalia

Omitted house numbers

4, 13, 14, 24, 34, 40-49 and 51

洋房號碼	洋房名稱
洋房 31	富豪·悦庭丹桂村路79C號
洋房 32	富豪·悦庭丹桂村路87B號
洋房 33	富豪·悦庭丹桂村路79D號
洋房 35	富豪·悦庭丹桂村路79E號
洋房 36	富豪·悦庭丹桂村路87C號
洋房 37	富豪·悦庭丹桂村路79F號
洋房 38	富豪·悦庭丹桂村路87D號
洋房 39	富豪·悦庭丹桂村路81號
洋房 50	富豪·悦庭丹桂村路87E號
洋房 52	富豪·悦庭丹桂村路89號

洋房被略去的門牌號數

4、13、14、24、34、40-49及51

Note:
The name of the street and street number of DOMUS is 65 Tan Kwai Tsuen Road.

備註:
尚築的街道名稱及門牌號數為丹桂村路65號。

INFORMATION ON VENDOR AND OTHERS INVOLVED IN THE DEVELOPMENT

賣方及有參與發展項目的其他人的資料

Vendor

Advance Fame Investments Limited
Lucky Achievement Limited *
Brilliant Enhancement Limited *
Multiple Achievement Limited *
New Multi-Profit Limited *
Equal Advantage Limited *
Super Residence Limited *

Holding company of the vendor

Lucky Vortex Limited
Cheer Enhancement Limited
Multiple Options Limited
New Multi-Gain Limited
Parallel Advantage Limited
Super Upsurge Limited
Advance Fame Investment Limited
Master Fame Investments Limited
P&R Holdings Limited
Paliburg Development BVI Holdings Limited
Paliburg Holdings Limited
Century City BVI Holdings Limited
Century City International Holdings Limited

Authorized person for the Development

Mr. Wong Po Man

The firm or corporation of which an authorized person for the Development is a proprietor, director or employee in his or her professional capacity

Paliburg Development Consultants Limited

Building contractor for the Development

Chatwin Engineering Limited

The firm of solicitors acting for the owner in relation to the sale of residential properties in the Development

Iu, Lai & Li Solicitors

Authorized institution that has made a loan, or has undertaken to provide finance, for the construction of the Development

The Bank of East Asia, Limited (The loan had been fully repaid)

Any other person who has made a loan for the construction of the Development

Master Fame Investments Limited

Remark *:

Advance Fame Investments Limited had assigned the following residential properties and parking spaces to its associated corporations:-

Name of associated corporation	Residential Property and Parking Space
Lucky Achievement Limited	67A Tan Kwai Tsuen Road, Casa Regalia and Residential Parking Spaces Nos. 1 and 2
Brilliant Enhancement Limited	69B Tan Kwai Tsuen Road, Casa Regalia and Residential Parking Spaces Nos. 7 and 8
Multiple Achievement Limited	73B Tan Kwai Tsuen Road, Casa Regalia and Residential Parking Spaces Nos. 15 and 16
New Multi-Profit Limited	83A Tan Kwai Tsuen Road, Casa Regalia and Residential Parking Spaces Nos. 70 and 71
Equal Advantage Limited	83G Tan Kwai Tsuen Road, Casa Regalia and Residential Parking Spaces Nos. 58 and 59
Super Residence Limited	89 Tan Kwai Tsuen Road, Casa Regalia and Residential Parking Spaces Nos. 39, 40 and 41

For the purpose of the Residential Properties (First-hand Sales) Ordinance and according to section 11 of that Ordinance, the relevant agreements for sale and purchase and assignments in respect of the above residential properties are not regarded as having been entered into/made in respect of the above residential properties. Therefore, the above associated corporations have become the respective vendor of the above residential properties.

賣方

晉茂投資有限公司
Lucky Achievement Limited *
Brilliant Enhancement Limited *
Multiple Achievement Limited *
New Multi-Profit Limited *
Equal Advantage Limited *
Super Residence Limited *

賣方的控權公司

Lucky Vortex Limited
Cheer Enhancement Limited
Multiple Options Limited
New Multi-Gain Limited
Parallel Advantage Limited
Super Upsurge Limited
晉茂投資有限公司
Master Fame Investments Limited
P&R Holdings Limited 百富控股有限公司
Paliburg Development BVI Holdings Limited
Paliburg Holdings Limited
Century City BVI Holdings Limited
Century City International Holdings Limited

發展項目的認可人士

黃寶文先生

發展項目的認可人士以其專業身分擔任經營人、董事或僱員的商號或法團

百利保發展顧問有限公司

發展項目的承建商

正宏工程有限公司

就發展項目中的住宅物業的出售而代表擁有人行事的律師事務所

姚黎李律師行

已為發展項目的建造提供貸款或已承諾為該項建造提供融資的認可機構

東亞銀行有限公司 (有關貸款已經全部還清)

已為發展項目的建造提供貸款的任何其他人

Master Fame Investments Limited

附註 *:

晉茂投資有限公司已將以下住宅物業及車位轉讓予其有聯繫法團：

有聯繫法團名稱	住宅物業及車位
Lucky Achievement Limited	富豪·悅庭丹桂村路 67A號及住宅車位1及2號
Brilliant Enhancement Limited	富豪·悅庭丹桂村路 69B號及住宅車位 7及 8號
Multiple Achievement Limited	富豪·悅庭丹桂村路 73B號及住宅車位15及16號
New Multi-Profit Limited	富豪·悅庭丹桂村路 83A號及住宅車位70及71號
Equal Advantage Limited	富豪·悅庭丹桂村路 83G號及住宅車位58及59號
Super Residence Limited	富豪·悅庭丹桂村路 89號及住宅車位39, 40及41號

為《一手住宅物業銷售條例》的目的及根據該條例的第11條，以上住宅物業之相關買賣合約及轉讓契不視為已就以上住宅物業而訂立/作出。因此，以上有聯繫法團分別成為以上住宅物業之賣方。

RELATIONSHIP BETWEEN PARTIES INVOLVED IN THE DEVELOPMENT
有參與發展項目的各方的關係

(a)	the vendor or a building contractor for the Development is an individual, and that vendor or contractor is an immediate family member of an authorized person for the Development. 賣方或有關發展項目的承建商屬個人，並屬該項目的認可人士的家人。	Not Applicable 不適用
(b)	the vendor or a building contractor for the Development is a partnership, and a partner of that vendor or contractor is an immediate family member of such an authorized person. 賣方或該項目的承建商屬合夥，而該賣方或承建商的合夥人屬上述認可人士的家人。	Not Applicable 不適用
(c)	the vendor or a building contractor for the Development is a corporation, and a director or the secretary of that vendor or contractor (or a holding company of that vendor) is an immediate family member of such an authorized person. 賣方或該項目的承建商屬法團，而該賣方或承建商（或該賣方的控權公司）的董事或秘書屬上述認可人士的家人。	No 否
(d)	the vendor or a building contractor for the Development is an individual, and that vendor or contractor is an immediate family member of an associate of such an authorized person. 賣方或該項目的承建商屬個人，並屬上述認可人士的有聯繫人士的家人。	Not Applicable 不適用
(e)	the vendor or a building contractor for the Development is a partnership, and a partner of that vendor or contractor is an immediate family member of an associate of such an authorized person. 賣方或該項目的承建商屬合夥，而該賣方或承建商的合夥人屬上述認可人士的有聯繫人士的家人。	Not Applicable 不適用
(f)	the vendor or a building contractor for the Development is a corporation, and a director or the secretary of that vendor or contractor (or a holding company of that vendor) is an immediate family member of an associate of such an authorized person. 賣方或該項目的承建商屬法團，而該賣方或承建商（或該賣方的控權公司）的董事或秘書屬上述認可人士的有聯繫人士的家人。	No 否
(g)	the vendor or a building contractor for the Development is an individual, and that vendor or contractor is an immediate family member of a proprietor of a firm of solicitors acting for the owner in relation to the sale of residential properties in the Development. 賣方或該項目的承建商屬個人，並屬就該項目內的住宅物業的出售代表擁有人行事的律師事務所行事的經營人的家人。	Not Applicable 不適用
(h)	the vendor or a building contractor for the Development is a partnership, and a partner of that vendor or contractor is an immediate family member of a proprietor of a firm of solicitors acting for the owner in relation to the sale of residential properties in the Development. 賣方或該項目的承建商屬合夥，而該賣方或承建商的合夥人屬就該項目內的住宅物業的出售代表擁有人行事的律師事務所行事的經營人的家人。	Not Applicable 不適用
(i)	the vendor or a building contractor for the Development is a corporation, and a director or the secretary of that vendor or contractor (or a holding company of that vendor) is an immediate family member of a proprietor of such a firm of solicitors. 賣方或該項目的承建商屬法團，而該賣方或承建商（或該賣方的控權公司）的董事或秘書屬上述律師事務所的經營人的家人。	No 否
(j)	the vendor, a holding company of the vendor, or a building contractor for the Development, is a private company, and an authorized person for the Development, or an associate of such an authorized person, holds at least 10% of the issued shares in that vendor, holding company or contractor. 賣方、賣方的控權公司或有關發展項目的承建商屬私人公司，而該項目的認可人士或該認可人士的有聯繫人士持有該賣方、控權公司或承建商最少 10% 的已發行股份。	No 否

(k)	the vendor, a holding company of the vendor, or a building contractor for the Development, is a listed company, and such an authorized person, or such an associate, holds at least 1% of the issued shares in that vendor, holding company or contractor. 賣方、賣方的控權公司或該項目的承建商屬上市公司，而上述認可人士或上述有聯繫人士持有該賣方、控權公司或承建商最少 1% 的已發行股份。	No 否
(l)	the vendor or a building contractor for the Development is a corporation, and such an authorized person, or such an associate, is an employee, director or secretary of that vendor or contractor or of a holding company of that vendor. 賣方或該項目的承建商屬法團，而上述認可人士或上述有聯繫人士屬該賣方、承建商或該賣方的控權公司的僱員、董事或秘書。	Yes 是
(m)	the vendor or a building contractor for the Development is a partnership, and such an authorized person, or such an associate, is an employee of that vendor or contractor. 賣方或該項目的承建商屬合夥，而上述認可人士或上述有聯繫人士屬該賣方或承建商的僱員。	Not Applicable 不適用
(n)	the vendor, a holding company of the vendor, or a building contractor for the Development, is a private company, and a proprietor of a firm of solicitors acting for the owner in relation to the sale of residential properties in the Development holds at least 10% of the issued shares in that vendor, holding company or contractor. 賣方、賣方的控權公司或該項目的承建商屬私人公司，而就該項目中的住宅物業的出售而代表擁有人行事的律師事務所的經營人持有該賣方、控權公司或承建商最少 10% 的已發行股份。	No 否
(o)	the vendor, a holding company of the vendor, or a building contractor for the Development, is a listed company, and a proprietor of such a firm of solicitors holds at least 1% of the issued shares in that vendor, holding company or contractor. 賣方、賣方的控權公司或該項目的承建商屬上市公司，而上述律師事務所的經營人持有該賣方、控權公司或承建商最少 1% 的已發行股份。	No 否
(p)	the vendor or a building contractor for the Development is a corporation, and a proprietor of such a firm of solicitors is an employee, director or secretary of that vendor or contractor or of a holding company of that vendor. 賣方或該項目的承建商屬法團，而上述律師事務所的經營人屬該賣方或承建商或該賣方的控權公司的僱員、董事或秘書。	No 否
(q)	the vendor or a building contractor for the Development is a partnership, and a proprietor of such a firm of solicitors is an employee of that vendor or contractor. 賣方或該項目的承建商屬合夥，而上述律師事務所的經營人屬該賣方或承建商的僱員。	Not Applicable 不適用
(r)	the vendor or a building contractor for the Development is a corporation, and the corporation of which an authorized person for the Development is a director or employee in his or her professional capacity is an associate corporation of that vendor or contractor or of a holding company of that vendor. 賣方或該項目的承建商屬法團，而該項目的認可人士以其專業身份擔任董事或僱員的法團為該賣方或承建商或該賣方的控權公司的有聯繫法團。	Yes 是
(s)	the vendor or a building contractor for the Development is a corporation, and that contractor is an associate corporation of that vendor or of a holding company of that vendor. 賣方或該項目的承建商屬法團，而該承建商屬該賣方或該賣方的控權公司的有聯繫法團。	Yes 是

INFORMATION ON DESIGN OF THE DEVELOPMENT

發展項目的設計的資料

There are non-structural prefabricated external walls and curtain walls forming part of the enclosing walls of the Development
發展項目有構成圍封牆的一部分的非結構的預製外牆及幕牆

The Thickness of the Non-Structural Prefabricated External Walls of DOMUS: Not applicable.

尚樂的非結構的預製外牆的厚度：不適用。

The Thickness of the Non-Structural Prefabricated External Walls of Houses: 150mm.

洋房的非結構的預製外牆的厚度：150毫米。

Schedule of Total Area of Non-Structural Prefabricated External Walls Forming Part of The Enclosing Walls (In respect of each Residential Property)

構成圍封牆的一部分的非結構的預製外牆總面積表（以每個住宅物業計）

House 洋房	Total area of the non-structural prefabricated external walls of each residential property (sq.m) 每個住宅物業的非結構的預製外牆總面積(平方米)
67A Tan Kwai Tsuen Road, Casa Regalia 富豪·悦庭丹桂村路 67A 號	4.476
67B Tan Kwai Tsuen Road, Casa Regalia 富豪·悦庭丹桂村路 67B 號	4.476
69A Tan Kwai Tsuen Road, Casa Regalia 富豪·悦庭丹桂村路 69A 號	4.476
69B Tan Kwai Tsuen Road, Casa Regalia 富豪·悦庭丹桂村路 69B 號	4.476
71A Tan Kwai Tsuen Road, Casa Regalia 富豪·悦庭丹桂村路 71A 號	4.578
71B Tan Kwai Tsuen Road, Casa Regalia 富豪·悦庭丹桂村路 71B 號	4.578
73A Tan Kwai Tsuen Road, Casa Regalia 富豪·悦庭丹桂村路 73A 號	4.578
73B Tan Kwai Tsuen Road, Casa Regalia 富豪·悦庭丹桂村路 73B 號	4.578
75A Tan Kwai Tsuen Road, Casa Regalia 富豪·悦庭丹桂村路 75A 號	2.892
75B Tan Kwai Tsuen Road, Casa Regalia 富豪·悦庭丹桂村路 75B 號	2.892
77A Tan Kwai Tsuen Road, Casa Regalia 富豪·悦庭丹桂村路 77A 號	2.892
77B Tan Kwai Tsuen Road, Casa Regalia 富豪·悦庭丹桂村路 77B 號	2.892
79A Tan Kwai Tsuen Road, Casa Regalia 富豪·悦庭丹桂村路 79A 號	2.160
79B Tan Kwai Tsuen Road, Casa Regalia 富豪·悦庭丹桂村路 79B 號	2.160
79C Tan Kwai Tsuen Road, Casa Regalia 富豪·悦庭丹桂村路 79C 號	2.160
79D Tan Kwai Tsuen Road, Casa Regalia 富豪·悦庭丹桂村路 79D 號	2.160
79E Tan Kwai Tsuen Road, Casa Regalia 富豪·悦庭丹桂村路 79E 號	2.160
79F Tan Kwai Tsuen Road, Casa Regalia 富豪·悦庭丹桂村路 79F 號	2.160

House 洋房	Total area of the non-structural prefabricated external walls of each residential property (sq.m) 每個住宅物業的非結構的預製外牆總面積(平方米)
81 Tan Kwai Tsuen Road, Casa Regalia 富豪·悦庭丹桂村路 81 號	1.823
83A Tan Kwai Tsuen Road, Casa Regalia 富豪·悦庭丹桂村路 83A 號	2.913
83B Tan Kwai Tsuen Road, Casa Regalia 富豪·悦庭丹桂村路 83B 號	2.913
83C Tan Kwai Tsuen Road, Casa Regalia 富豪·悦庭丹桂村路 83C 號	2.913
83D Tan Kwai Tsuen Road, Casa Regalia 富豪·悦庭丹桂村路 83D 號	2.913
83E Tan Kwai Tsuen Road, Casa Regalia 富豪·悦庭丹桂村路 83E 號	2.913
83F Tan Kwai Tsuen Road, Casa Regalia 富豪·悦庭丹桂村路 83F 號	2.913
83G Tan Kwai Tsuen Road, Casa Regalia 富豪·悦庭丹桂村路 83G 號	2.913
85A Tan Kwai Tsuen Road, Casa Regalia 富豪·悦庭丹桂村路 85A 號	2.892
85B Tan Kwai Tsuen Road, Casa Regalia 富豪·悦庭丹桂村路 85B 號	2.892
85C Tan Kwai Tsuen Road, Casa Regalia 富豪·悦庭丹桂村路 85C 號	2.892
85D Tan Kwai Tsuen Road, Casa Regalia 富豪·悦庭丹桂村路 85D 號	2.892
87A Tan Kwai Tsuen Road, Casa Regalia 富豪·悦庭丹桂村路 87A 號	2.160
87B Tan Kwai Tsuen Road, Casa Regalia 富豪·悦庭丹桂村路 87B 號	2.160
87C Tan Kwai Tsuen Road, Casa Regalia 富豪·悦庭丹桂村路 87C 號	2.160
87D Tan Kwai Tsuen Road, Casa Regalia 富豪·悦庭丹桂村路 87D 號	2.160
87E Tan Kwai Tsuen Road, Casa Regalia 富豪·悦庭丹桂村路 87E 號	2.160
89 Tan Kwai Tsuen Road, Casa Regalia 富豪·悦庭丹桂村路 89 號	2.986

The Thickness of the Curtain Walls of DOMUS: 300mm.

尚築的非結構的幕牆的厚度：300毫米。

The Thickness of the Curtain Walls of Houses: 300mm.

洋房的非結構的幕牆的厚度：300毫米。

Schedule of Total Area of Curtain Walls Forming Part of The Enclosing Walls (In respect of each Residential Property)
構成圍封牆的一部分的幕牆總面積表（以每個住宅物業計）

Multi-unit building 多單位建築物	Floor 樓層	Flat 單位	Total area of curtain walls of each residential property (sq.m) 每個住宅物業的幕牆的總面積 (平方米)
DOMUS 尚築	G/F 地下	1	0.622
		2	0.386
		3	0.984
		5	0.386
		6	0.386
		7	0.386
		8	0.386
		9	0.386
		10	0.386
		11	0.386
		12	0.645
		15	0.645
		16	0.386
		17	0.386
		18	0.386
		19	0.386
		20	0.386
		21	0.386
		22	0.334
		23	0.386
		25	0.386
		26	0.386
		27	0.386
		28	0.386
		29	0.645
		30	0.645
		31	0.386
		32	0.386
		33	0.401
		35	0.401
		36	0.386
		37	0.386
		38	0.386

Multi-unit building 多單位建築物	Floor 樓層	Flat 單位	Total area of curtain walls of each residential property (sq.m) 每個住宅物業的幕牆的總面積 (平方米)
DOMUS 尚築	1/F-3/F 1樓至3樓	1	0.563
		2	0.563
		3	0.563
		5	1.126
		6	0.563
		7	0.563
		8	0.563
		9	0.563
		10	0.563
		11	0.563
		12	0.563
		15	1.201
		16	1.201
		17	0.563
		18	0.563
		19	0.563
		20	0.563
		21	0.563
		22	0.563
		23	0.394
		25	0.563
		26	0.563
		27	0.465
		28	0.563
		31	0.833
		32	0.563
		33	0.563
		35	0.964
		36	0.964
		37	0.563
	38	0.563	
	39	0.563	
	1/F-2/F 1樓至2樓	29	0.563
	30	0.833	
3/F 3樓	30	1.890	

INFORMATION ON DESIGN OF THE DEVELOPMENT
發展項目的設計的資料

Schedule of Total Area of Curtain Walls Forming Part of The Enclosing Walls (In respect of each Residential Property)
構成圍封牆的一部分的幕牆總面積表 (以每個住宅物業計)

House 洋房	Total area of curtain walls of each residential property (sq.m) 每個住宅物業的幕牆的總面積 (平方米)
67A Tan Kwai Tsuen Road, Casa Regalia 富豪·悅庭丹桂村路 67A 號	4.788
67B Tan Kwai Tsuen Road, Casa Regalia 富豪·悅庭丹桂村路 67B 號	4.788
69A Tan Kwai Tsuen Road, Casa Regalia 富豪·悅庭丹桂村路 69A 號	4.788
69B Tan Kwai Tsuen Road, Casa Regalia 富豪·悅庭丹桂村路 69B 號	4.788
71A Tan Kwai Tsuen Road, Casa Regalia 富豪·悅庭丹桂村路 71A 號	5.322
71B Tan Kwai Tsuen Road, Casa Regalia 富豪·悅庭丹桂村路 71B 號	5.322
73A Tan Kwai Tsuen Road, Casa Regalia 富豪·悅庭丹桂村路 73A 號	5.322
73B Tan Kwai Tsuen Road, Casa Regalia 富豪·悅庭丹桂村路 73B 號	5.322
75A Tan Kwai Tsuen Road, Casa Regalia 富豪·悅庭丹桂村路 75A 號	4.368
75B Tan Kwai Tsuen Road, Casa Regalia 富豪·悅庭丹桂村路 75B 號	4.368
77A Tan Kwai Tsuen Road, Casa Regalia 富豪·悅庭丹桂村路 77A 號	4.368
77B Tan Kwai Tsuen Road, Casa Regalia 富豪·悅庭丹桂村路 77B 號	4.368
79A Tan Kwai Tsuen Road, Casa Regalia 富豪·悅庭丹桂村路 79A 號	3.918
79B Tan Kwai Tsuen Road, Casa Regalia 富豪·悅庭丹桂村路 79B 號	3.918
79C Tan Kwai Tsuen Road, Casa Regalia 富豪·悅庭丹桂村路 79C 號	3.918
79D Tan Kwai Tsuen Road, Casa Regalia 富豪·悅庭丹桂村路 79D 號	3.918
79E Tan Kwai Tsuen Road, Casa Regalia 富豪·悅庭丹桂村路 79E 號	3.918
79F Tan Kwai Tsuen Road, Casa Regalia 富豪·悅庭丹桂村路 79F 號	3.918

House 洋房	Total area of curtain walls of each residential property (sq.m) 每個住宅物業的幕牆的總面積 (平方米)
81 Tan Kwai Tsuen Road, Casa Regalia 富豪·悅庭丹桂村路 81 號	9.939
83A Tan Kwai Tsuen Road, Casa Regalia 富豪·悅庭丹桂村路 83A 號	5.322
83B Tan Kwai Tsuen Road, Casa Regalia 富豪·悅庭丹桂村路 83B 號	5.322
83C Tan Kwai Tsuen Road, Casa Regalia 富豪·悅庭丹桂村路 83C 號	5.322
83D Tan Kwai Tsuen Road, Casa Regalia 富豪·悅庭丹桂村路 83D 號	5.322
83E Tan Kwai Tsuen Road, Casa Regalia 富豪·悅庭 83E 號丹桂村路	5.322
83F Tan Kwai Tsuen Road, Casa Regalia 富豪·悅庭丹桂村路 83F 號	5.322
83G Tan Kwai Tsuen Road, Casa Regalia 富豪·悅庭丹桂村路 83G 號	5.322
85A Tan Kwai Tsuen Road, Casa Regalia 富豪·悅庭丹桂村路 85A 號	4.368
85B Tan Kwai Tsuen Road, Casa Regalia 富豪·悅庭丹桂村路 85B 號	4.368
85C Tan Kwai Tsuen Road, Casa Regalia 富豪·悅庭丹桂村路 85C 號	4.368
85D Tan Kwai Tsuen Road, Casa Regalia 富豪·悅庭丹桂村路 85D 號	4.368
87A Tan Kwai Tsuen Road, Casa Regalia 富豪·悅庭丹桂村路 87A 號	3.918
87B Tan Kwai Tsuen Road, Casa Regalia 富豪·悅庭丹桂村路 87B 號	3.918
87C Tan Kwai Tsuen Road, Casa Regalia 富豪·悅庭丹桂村路 87C 號	3.918
87D Tan Kwai Tsuen Road, Casa Regalia 富豪·悅庭丹桂村路 87D 號	3.918
87E Tan Kwai Tsuen Road, Casa Regalia 富豪·悅庭丹桂村路 87E 號	3.918
89 Tan Kwai Tsuen Road, Casa Regalia 富豪·悅庭丹桂村路 89 號	9.974

THE MANAGER APPOINTED UNDER THE DEED OF MUTUAL COVENANT

Regal Estate Management Limited has been appointed as the manager of the Development under the deed of mutual covenant in respect of the Development.

根據公契獲委任的管理人

根據公契，富豪物業管理有限公司已獲委任為發展項目的管理人。

LOCATION PLAN OF THE DEVELOPMENT 發展項目的所在位置圖

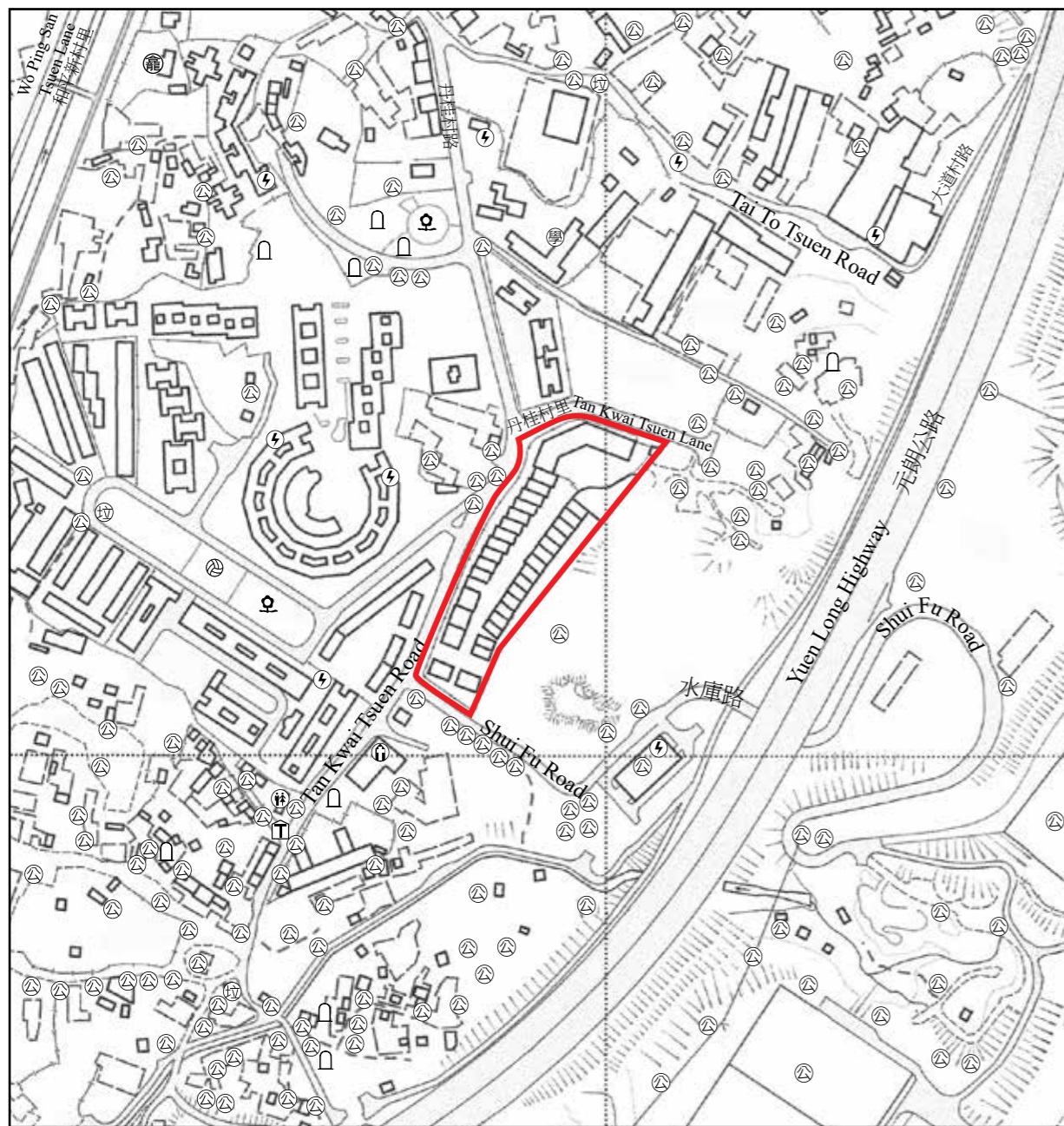

Notation 圖例

-  A public convenience 公廁
-  A religious institution (including a church, a temple and a Tsz Tong) 宗教場所 (包括教堂、廟宇及祠堂)
-  Sports facilities (including a sports ground and a swimming pool) 體育設施 (包括運動場及游泳池)
-  A power plant (including electricity sub-stations) 發電廠 (包括電力分站)
-  A public park 公園
-  A school (including a kindergarten) 學校 (包括幼稚園)
-  A public utility installation 公用事業設施裝置
-  A refuse collection point 垃圾收集站
-  A cemetery 墳場
-  A public transport terminal (including a rail station) 公共交通總站 (包括鐵路車站)
-  A columbarium 骨灰龕



 Location of the Development
發展項目的位置

0M / 米
Scale:  250M / 米
比例:

The above Location Plan is prepared by the vendor with reference to the Survey Sheet No. 6-NW-C dated 12 July 2018, with adjustments where necessary.

上述位置圖參考於日期為 2018 年 7 月 12 日修訂之測繪圖編號 6-NW-C 並由賣方擬備，經修正處理。

Notes:

1. The map is reproduced with permission of the Director of Lands © The Government of Hong Kong SAR. Licence No. 63/2018.
2. The vendor advises prospective purchasers to conduct on-site visit for a better understanding of the development site, its surrounding environment and the public facilities nearby.
3. The above plan shows slightly more than the area required under the Residential Properties (First-hand Sales) Ordinance due to the technical reason that the boundary of the Development is irregular.

備註:

1. 地圖版權屬香港特別行政區政府，經地政總署准許複印，版權特許編號63/2018。
2. 賣方建議準買方到該發展地盤作實地考察，以對該發展地盤、其周邊環境及附近的公共設施有較佳的了解。
3. 由於發展項目的邊界不規則的技術原因，上圖顯示稍多於〈一手住宅物業銷售條例〉所要求顯示的範圍。



● Location of the Development
發展項目的位置

Survey and Mapping Office, Lands Department, The Government of HKSAR © Copyright reserved-reproduction by permission only.

香港特別行政區政府地政總處測繪處©版權所有，未經許可，不得複製。

Adopted from part of the aerial photograph taken by the Survey and Mapping Office of Lands Department at a flying height of 6,900 feet, Photo No.E035348C, dated 13 March 2018.

摘錄自地政總署測繪處於2018年3月13日在6,900呎飛行高度拍攝之鳥瞰照片，編號為E035348C。

Notes:

1. The above aerial photograph is available for free inspection at the sales office(s) during opening hours.
2. The above aerial photograph shows slightly more than the area required under the Residential Properties (First-hand Sales) Ordinance due to the technical reason that the boundary of the Development is irregular.

備註：

1. 上述鳥瞰照片可於開放時間向售樓處免費查閱。
2. 由於發展項目的邊界不規則的技術原因，上述鳥瞰照片顯示稍多於〈一手住宅物業銷售條例〉所要求顯示的範圍。

AERIAL PHOTOGRAPH OF THE DEVELOPMENT
發展項目的鳥瞰照片

This blank area falls outside the coverage of the aerial photograph.
此空白範圍不為本鳥瞰照片所覆蓋。

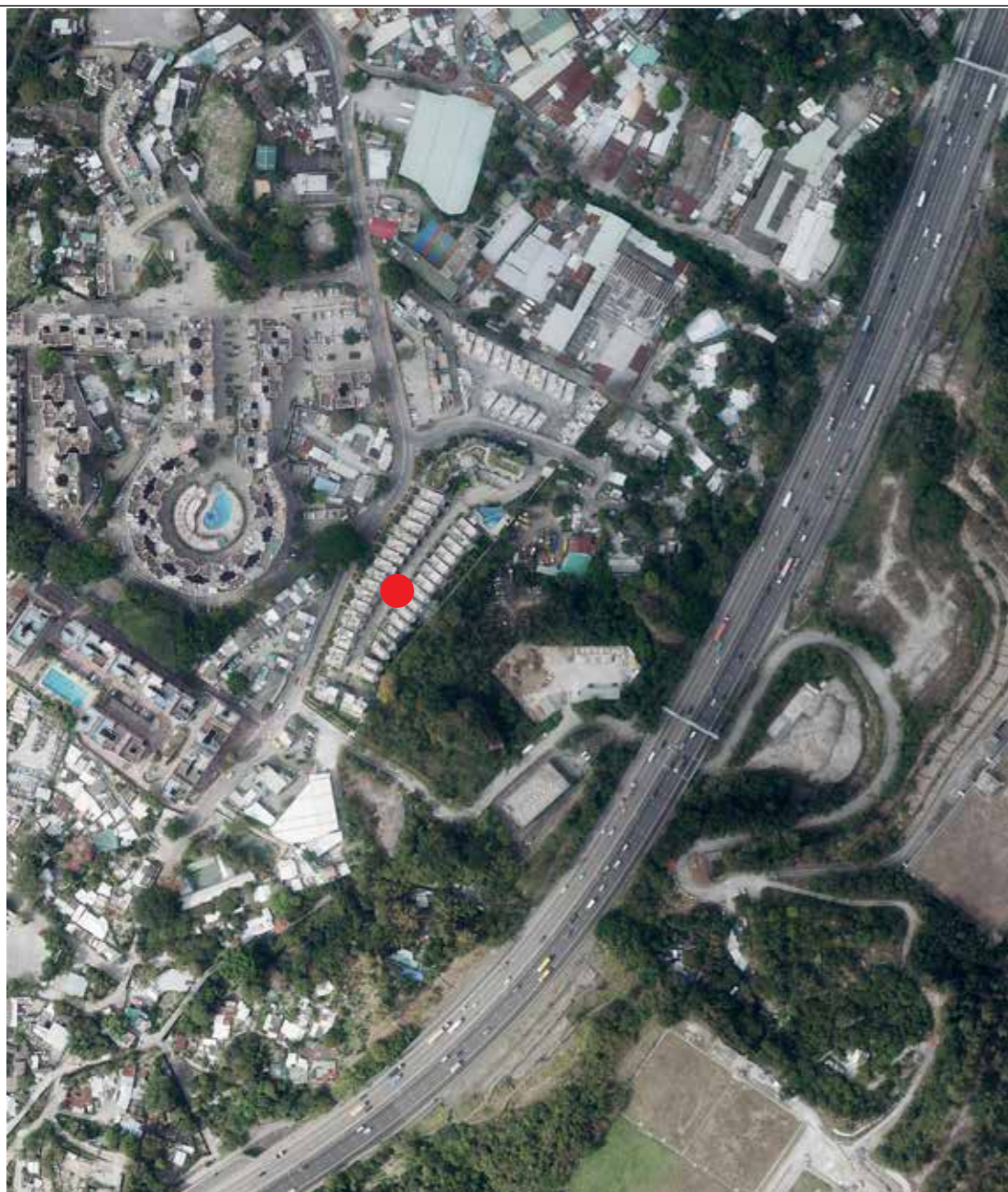

● Location of the Development
發展項目的位置

Survey and Mapping Office, Lands Department, The Government of HKSAR © Copyright reserved-reproduction by permission only.
香港特別行政區政府地政總處測繪處©版權所有，未經許可，不得複製。

Adopted from part of the aerial photograph taken by the Survey and Mapping Office of Lands Department at a flying height of 6,900 feet, Photo No.E035349C, dated 13 March 2018.
摘錄自地政總署測繪處於2018年3月13日在6,900呎飛行高度拍攝之鳥瞰照片，編號為E035349C。

Notes:

1. The above aerial photograph is available for free inspection at the sales office(s) during opening hours.
2. The above aerial photograph shows slightly more than the area required under the Residential Properties (First-hand Sales) Ordinance due to the technical reason that the boundary of the Development is irregular.

備註：

1. 上述鳥瞰照片可於開放時間向售樓處免費查閱。
2. 由於發展項目的邊界不規則的技術原因，上述鳥瞰照片顯示稍多於〈一手住宅物業銷售條例〉所要求顯示的範圍。

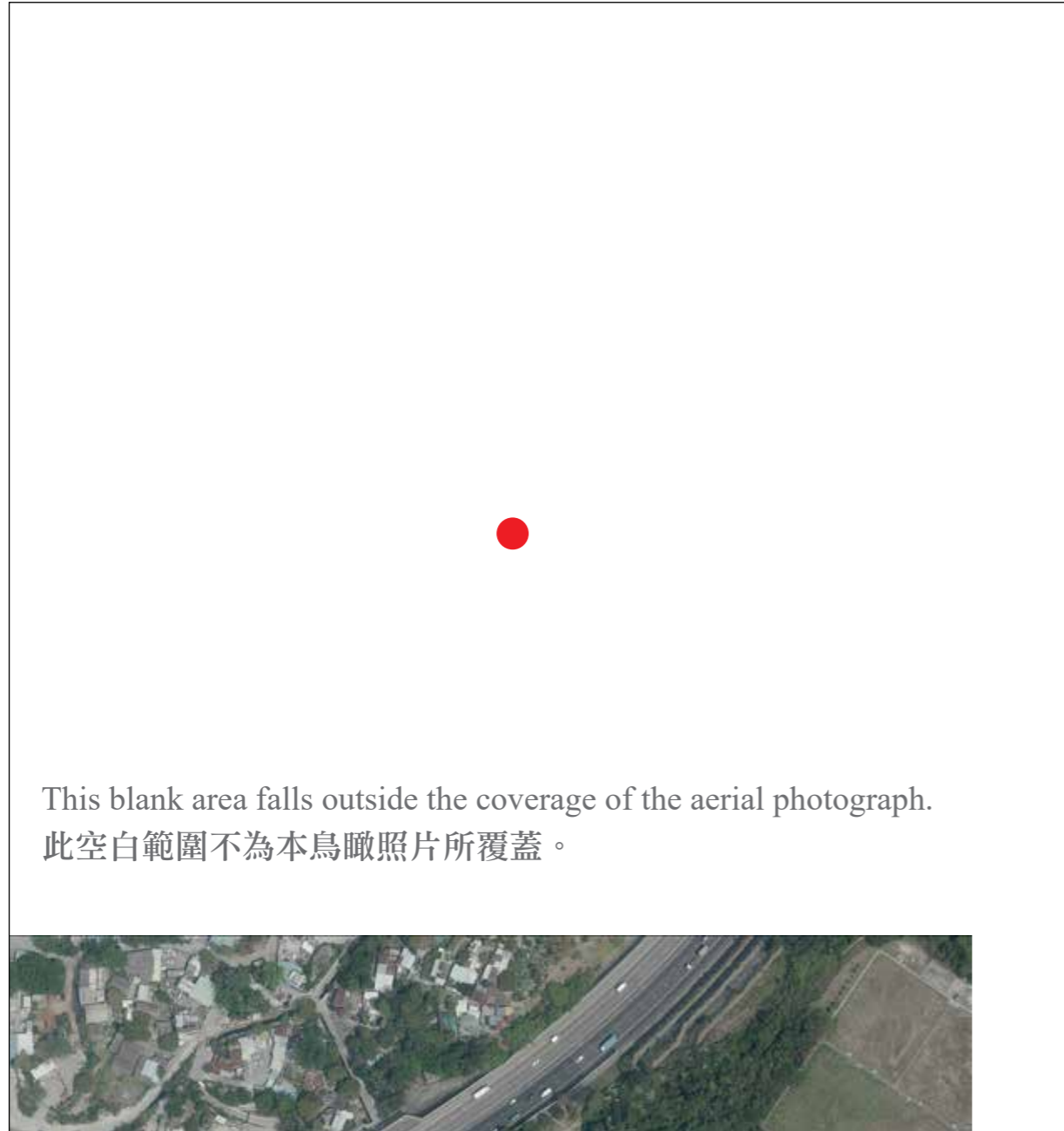

● Location of the Development
發展項目的位置

Survey and Mapping Office, Lands Department, The Government of HKSAR © Copyright reserved-reproduction by permission only.
香港特別行政區政府地政總處測繪處©版權所有，未經許可，不得複製。

Adopted from part of the aerial photograph taken by the Survey and Mapping Office of Lands Department at a flying height of 6,900 feet, Photo No.E036667C, dated 22 March 2018.
摘錄自地政總署測繪處於2018年3月22日在6,900呎飛行高度拍攝之鳥瞰照片，編號為E036667C。

Notes:

1. The above aerial photograph is available for free inspection at the sales office(s) during opening hours.
2. The above aerial photograph shows slightly more than the area required under the Residential Properties (First-hand Sales) Ordinance due to the technical reason that the boundary of the Development is irregular.

備註：

1. 上述鳥瞰照片可於開放時間向售樓處免費查閱。
2. 由於發展項目的邊界不規則的技術原因，上述鳥瞰照片顯示稍多於〈一手住宅物業銷售條例〉所要求顯示的範圍。



This blank area falls outside the coverage of the aerial photograph.
此空白範圍不為本鳥瞰照片所覆蓋。



● Location of the Development
發展項目的位置

Survey and Mapping Office, Lands Department, The Government of HKSAR © Copyright reserved-reproduction by permission only.
香港特別行政區政府地政總處測繪處©版權所有，未經許可，不得複製。

Adopted from part of the aerial photograph taken by the Survey and Mapping Office of Lands Department at a flying height of 6,900 feet, Photo No.E036666C, dated 22 March 2018.
摘錄自地政總署測繪處於2018年3月22日在6,900呎飛行高度拍攝之鳥瞰照片，編號為E036666C。

Notes:

1. The above aerial photograph is available for free inspection at the sales office(s) during opening hours.
2. The above aerial photograph shows slightly more than the area required under the Residential Properties (First-hand Sales) Ordinance due to the technical reason that the boundary of the Development is irregular.

備註：

1. 上述鳥瞰照片可於開放時間向售樓處免費查閱。
2. 由於發展項目的邊界不規則的技術原因，上述鳥瞰照片顯示稍多於〈一手住宅物業銷售條例〉所要求顯示的範圍。

This page is left blank intentionally.
此頁保留空白。

OUTLINE ZONING PLAN RELATING TO THE DEVELOPMENT 關乎發展項目的分區計劃大綱圖

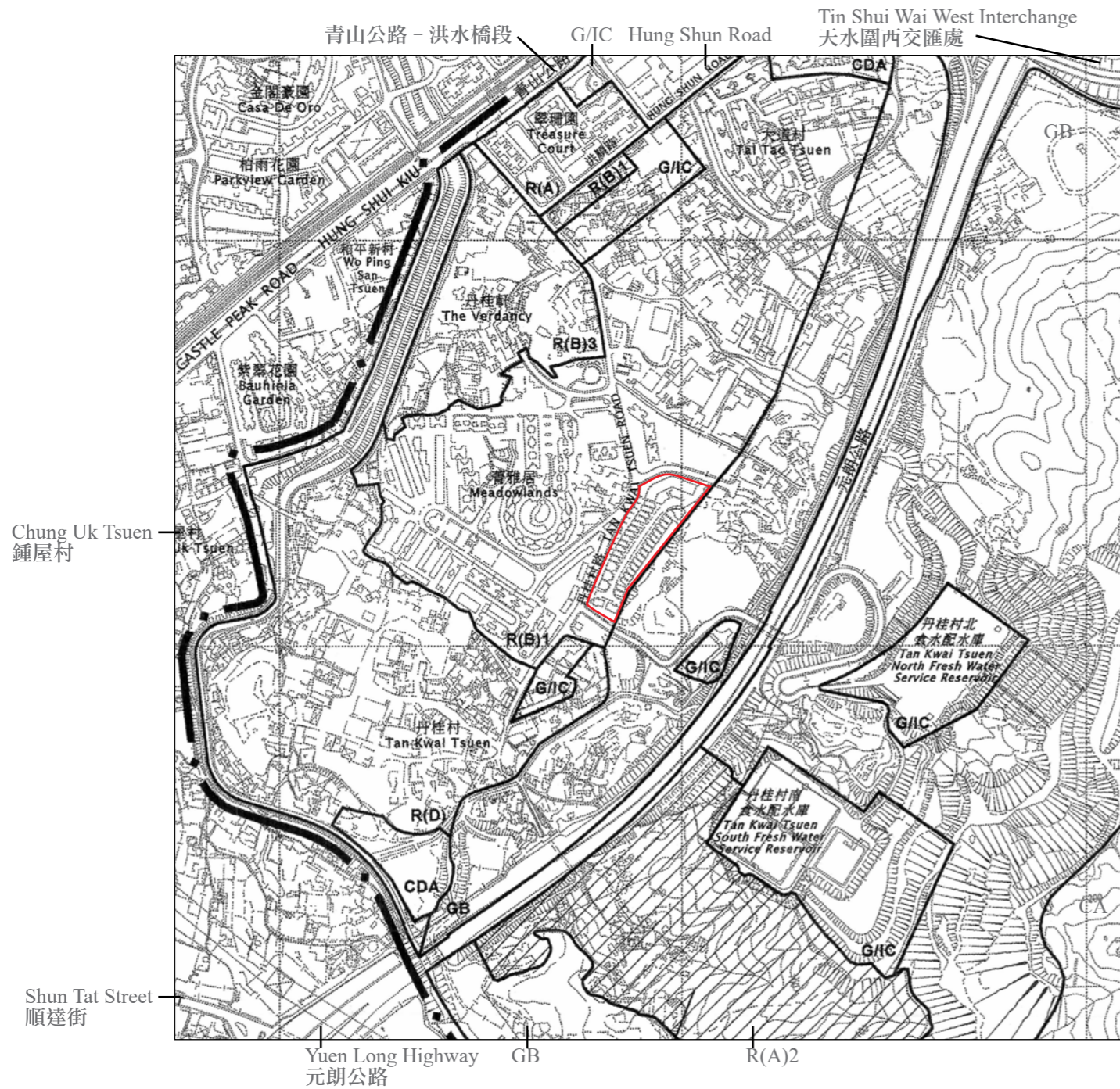

NOTATION 圖例

ZONES 地帶

CDA	Comprehensive Development Area 綜合發展區
R(A)	Residential (Group A) 住宅 (甲類)
R(B)	Residential (Group B) 住宅 (乙類)
R(D)	Residential (Group D) 住宅 (丁類)
G/IC	Government, Institution or Community 政府、機構或社區
GB	Green Belt 綠化地帶
CA	Conservation Area 自然保育區

COMMUNICATIONS 交通

+	Major Road and Junction 主要道路及路口
---	---------------------------------

MISCELLANEOUS 其他

- · -	Boundary of Planning Scheme 規劃範圍界線
-------	------------------------------------



Location of the Development
發展項目的位置

Scale: 0M / 米 500M / 米
比例:

Part of the draft Tong Yan San Tsuen Outline Zoning Plan with Plan No. S/YL-TYST/11 gazetted on 29 September 2017.

摘錄自 2017 年 9 月 29 日刊憲之唐人新村分區計劃大綱草圖，圖則編號 S/YL-TYST/11。

Notes:

- The above Outline Zoning Plan, prepared by the Planning Department under the direction of the Town Planning Board is reproduced with permission of the Director of Land © The Government of Hong Kong SAR.
- The above Outline Zoning Plan is available for free inspection at the sales office(s) during opening hours.
- The vendor advises purchasers to conduct on-site visit for a better understanding of the Development site, its surrounding environment and the public facilities nearby.
- The above plan shows slightly more than the area required under the Residential Properties (First-hand Sales) Ordinance due to the technical reason that the boundary of the Development is irregular.

備註:

- 上述分區計劃大綱圖，為規劃署遵照城市規劃委員會指示擬備，版權屬香港特別行政區政府，經地政總署准許複印。
- 上述分區計劃大綱圖可於開放時間向售樓處免費查閱。
- 賣方建議準買方到該發展地盤作實地考察，以對該發展地盤、其周邊地區環境及附近的公共設施有較佳的了解。
- 由於發展項目的邊界不規則的技術原因，上圖顯示稍多於〈一手住宅物業銷售條例〉所要求的範圍。

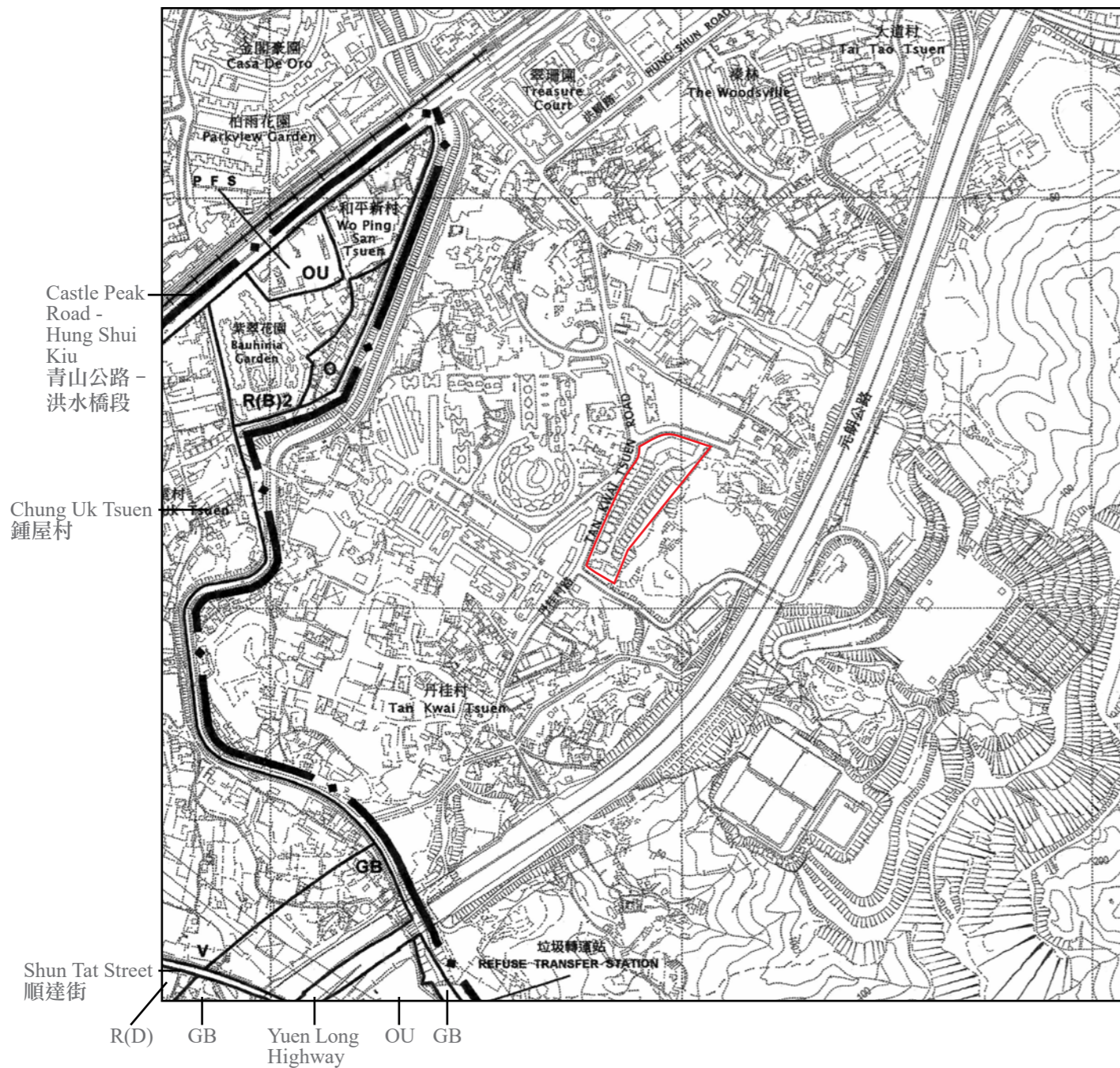

NOTATION 圖例

ZONES 地帶

- R(B) Residential (Group B) 住宅 (乙類)
- R(D) Residential (Group D) 住宅 (丁類)
- v Village Type Development 鄉村式發展
- o Open Space 休憩用地
- OU Other Specified Uses 其他指定用途
- GB Green Belt 綠化地帶

COMMUNICATIONS 交通

- Major Road and Junction
主要道路及路口
- Light Rail 輕鐵

MISCELLANEOUS 其他

- Boundary of Planning Scheme
規劃範圍界線
- PFS Petrol Filling Station
加油站



- Location of the Development
發展項目的位置

Scale: 0M / 米 500M / 米
 比例:

Part of the draft Lam Tei and Yick Yuen Outline Zoning Plan with Plan No. S/TM-LTY9/9 gazetted on 26 May 2017.

摘錄自 2017 年 5 月 26 日刊憲之藍地及亦園分區計劃大綱草圖，圖則編號 S/TM-LTY9/9。

Notes:

1. The above Outline Zoning Plan, prepared by the Planning Department under the direction of the Town Planning Board is reproduced with permission of the Director of Land © The Government of Hong Kong SAR.
2. The above Outline Zoning Plan is available for free inspection at the sales office(s) during opening hours.
3. The vendor advises purchasers to conduct on-site visit for a better understanding of the Development site, its surrounding environment and the public facilities nearby.
4. The above plan shows slightly more than the area required under the Residential Properties (First-hand Sales) Ordinance due to the technical reason that the boundary of the Development is irregular.

備註:

1. 上述分區計劃大綱圖，為規劃署遵照城市規劃委員會指示擬備，版權屬香港特別行政區政府，經地政總署准許複印。
2. 上述分區計劃大綱圖可於開放時間向售樓處免費查閱。
3. 賣方建議準買方到該發展地盤作實地考察，以對該發展地盤、其周邊地區環境及附近的公共設施有較佳的了解。
4. 由於發展項目的邊界不規則的技術原因，上圖顯示稍多於〈一手住宅物業銷售條例〉所要求的範圍。

OUTLINE ZONING PLAN RELATING TO THE DEVELOPMENT 關於發展項目的分區計劃大綱圖

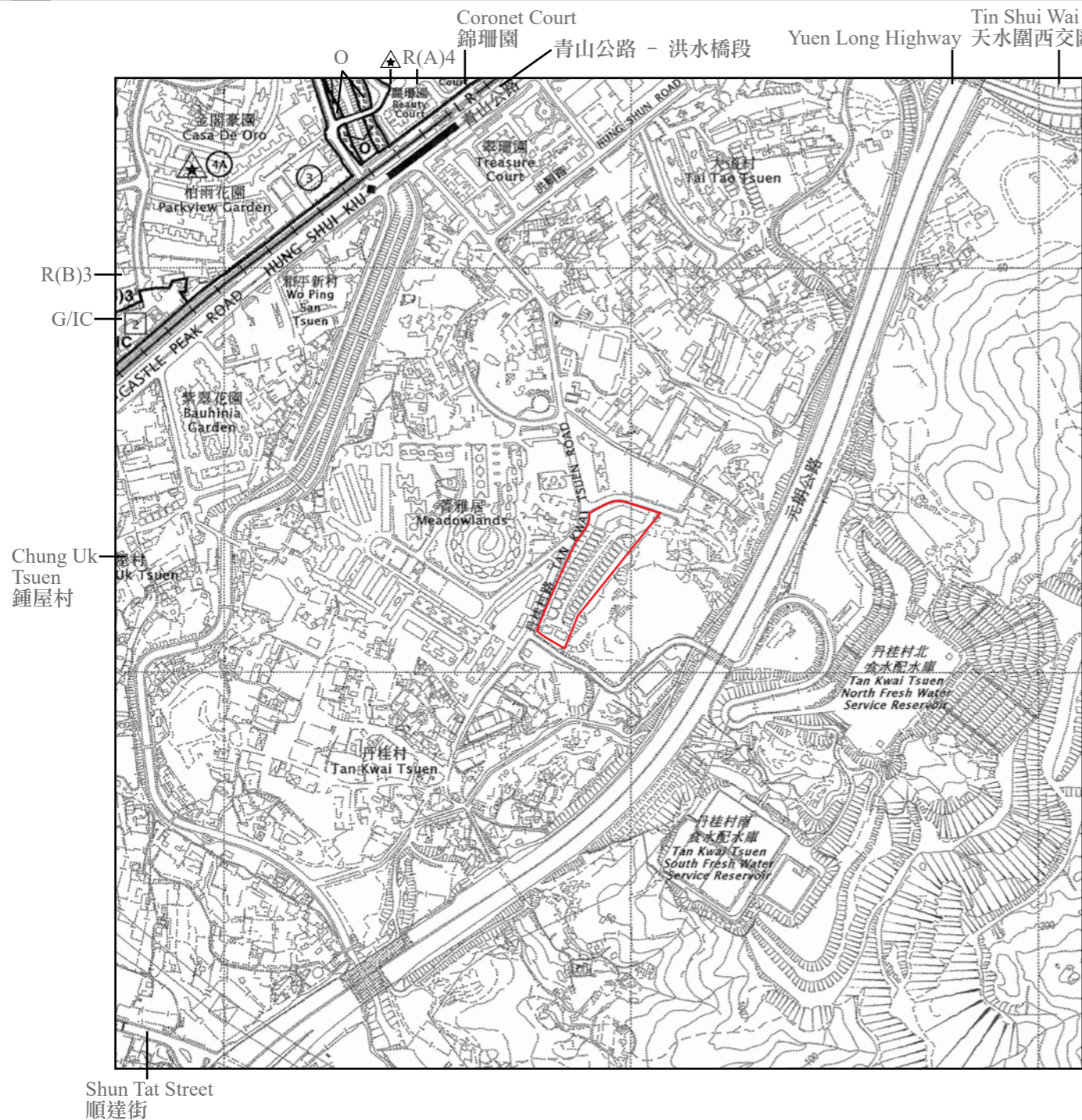

NOTATION 圖例

ZONES 地帶

- R(A) Residential (Group A) 住宅 (甲類)
- R(B) Residential (Group B) 住宅 (乙類)
- G/C Government, Institution or Community 政府、機構或社區
- O Open Space 休憩用地

COMMUNICATIONS 交通

- Light Rail 輕鐵
- Major Road and Junction 主要道路及路口

MISCELLANEOUS 其他

- Boundary of Planning Scheme 規劃範圍界線
- 1 Planning Area Number 規劃區編號
- Maximum Building Height Restriction as Stipulated on the Notes 《註釋》內訂明最高建築物高度限制
- 8 Maximum Building Height (In Number of Storeys) 最高建築物高度 (樓層數目)
- Area Designated for 'Riverside Promenade' 指定為「河畔長廊」的地區



 Location of the Development
發展項目的位置

Scale: 0M / 米 500M / 米
比例:

Part of the draft Hung Shui Kiu and Ha Tsuen Outline Zoning Plan with Plan No. S/HSK/1 gazetted on 26 May 2017.
摘錄自 2017 年 5 月 26 日刊憲之洪水橋及廈村分區計劃大綱草圖，圖則編號 S/HSK/1。

Notes:

1. The above Outline Zoning Plan, prepared by the Planning Department under the direction of the Town Planning Board is reproduced with permission of the Director of Land © The Government of Hong Kong SAR.
2. The above Outline Zoning Plan is available for free inspection at the sales office(s) during opening hours.
3. The vendor advises purchasers to conduct on-site visit for a better understanding of the Development site, its surrounding environment and the public facilities nearby.
4. The above plan shows slightly more than the area required under the Residential Properties (First-hand Sales) Ordinance due to the technical reason that the boundary of the Development is irregular.

備註:

1. 上述分區計劃大綱圖，為規劃署遵照城市規劃委員會指示擬備，版權屬香港特別行政區政府，經地政總署准許複印。
2. 上述分區計劃大綱圖可於開放時間向售樓處免費查閱。
3. 賣方建議準買方到該發展地盤作實地考察，以對該發展地盤、其周邊地區環境及附近的公共設施有較佳的了解。
4. 由於發展項目的邊界不規則的技術原因，上圖顯示稍多於〈一手住宅物業銷售條例〉所要求的範圍。

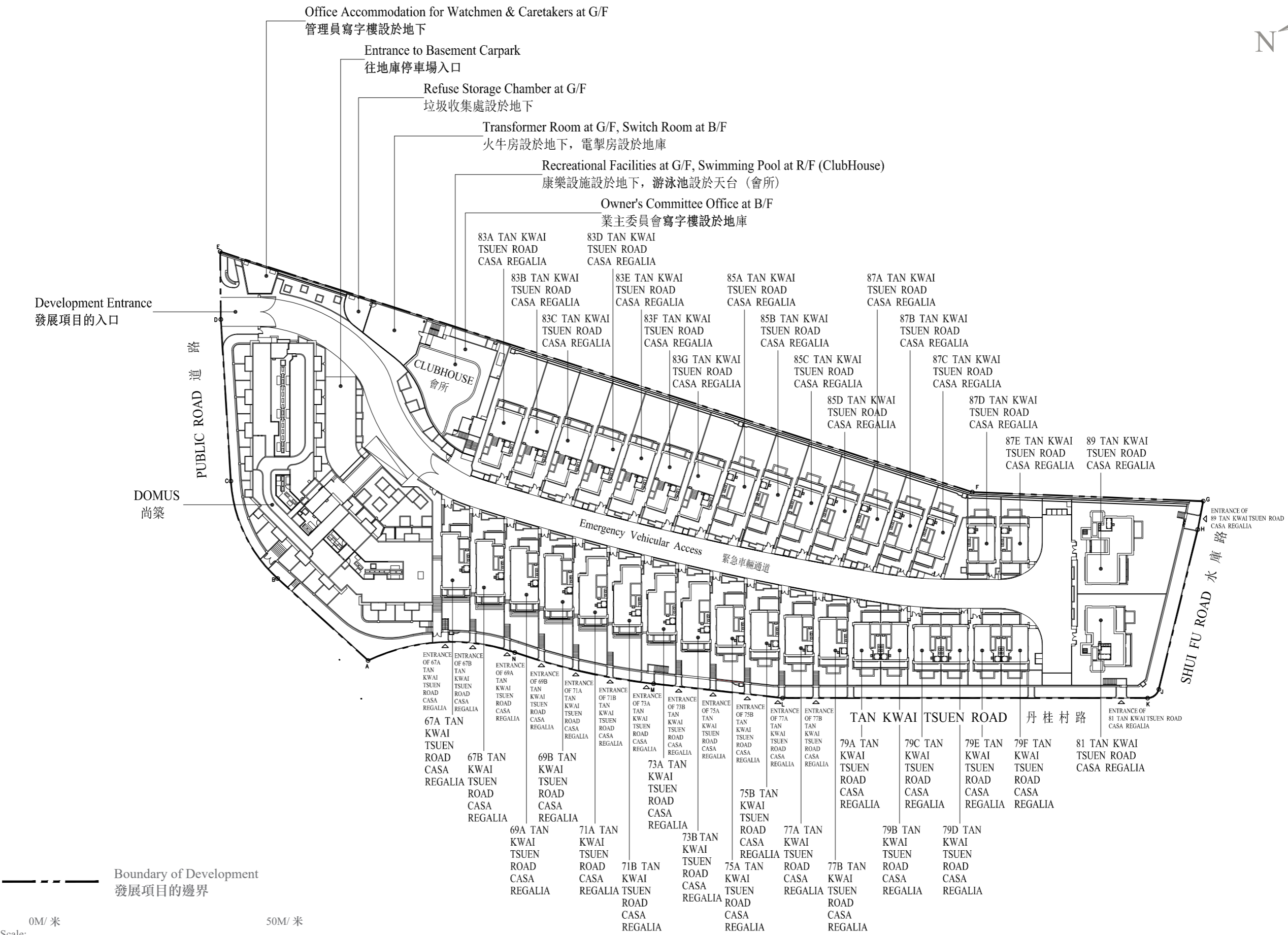

FLOOR PLANS OF RESIDENTIAL PROPERTIES IN THE DEVELOPMENT

發展項目的住宅物業的樓面平面圖

Legend 圖例

AF ABOVE = ARCHITECTURAL FEATURE ABOVE = 上層建築裝飾
APARTMENT = 大樓
BAL = BALCONY = 露台
BAL ABOVE = BALCONY ABOVE = 上層露台
BATH = BATHROOM = 浴室
BEDROOM = 睡房
CANOPY = 簷篷
CANOPY ABOVE = 上層簷篷
CAR PARK = 停車場
CLUBHOUSE = 會所
CORRIDOR = 走廊
CW = CURTAIN WALL = 玻璃幕牆
CW ABOVE = CURTAIN WALL ABOVE = 上層玻璃幕牆
D = DOWN = 下
DIN = DINING ROOM = 飯廳
ELV & TEL = EXTRA LOW VOLTAGE ELECTRICAL & TELEPHONE ROOM = 低電壓及電話機房
EL ROOM = ELECTRIC ROOM = 電掣房
EMC = ELECTRICAL METER CABINET = 電錶箱
EMR = ELECTRICAL METER ROOM = 電錶房
FH / FS INLET = FIRE HYDRANT / FIRE SERVICE INLET = 消防栓及消防入水掣
FS / SPK INLET = FIRE SERVICE / SPRINKLER INLET = 消防及消防花灑入水掣
FLAT = 單位
FLAT ROOF = 平台
FS PUMP ROOM = FIRE SERVICE PUMP ROOM = 消防設備泵房
FS WATER TANK = FIRE SERVICE WATER TANK = 消防水箱
GARDEN = 花園
GLASS CANOPY = 玻璃簷篷
GUEST LAV = GUEST LAVATORY = 客人洗手間
HOU = HOUSE = 洋房
HR = HOSE REEL = 消防喉轆
KIT = KITCHEN = 廚房
LAWN = 草地
LAV = LAVATORY = 洗手間
LIFT = 升降機
LIFT LOBBY = 升降機大堂
LIFT MACHINE ROOM = 升降機機房

LIV = LIVING ROOM = 客廳
MCB = MINIATURE CIRCUIT BREAKER = 總電掣箱
M BATH = MASTER BATHROOM = 主人浴室
MASTER BEDROOM = 主人睡房
MV = MECHANICAL VENTILATION = 機械通風
OPEN KIT = OPEN KITCHEN = 開放式廚房
PD = PIPE DUCT = 喉管管道槽
PLANTER = 花槽
RC CANOPY = REINFORCED CONCRETE CANOPY = 石屎簷篷
RAMP = 斜路
RS / MRR = REFUSE STORAGE / MATERIAL RECOVERY ROOM = 垃圾及物料回收房
ROOF = 天台
SMATV ROOM = SATELLITE MASTER ANTENNA TELEVISION = 衛星天線設備房
ST RM = STORE = 儲物房
TEL = TELEPHONE CABINET = 電話線箱
TD = TELEPHONE DUCT = 電話線槽
U = UP = 上
UPPER ROOF = 天台高層
VOID = 中空
VD = VENT DUCT = 排氣管道
WMC = WATER METER CABINET = 水錶箱
WMR = WATER METER ROOM = 水錶房

DOMUS 尚築

G/F Floor Plan 地下平面圖



The thickness of the floor slabs (excluding plaster) (mm) 樓板(不包括灰泥)的厚度(毫米)	The floor-to-floor height (mm) 層與層之間的高度(毫米)
125, 150, 175	3250

The internal areas of the residential properties on the upper floors will generally be slightly larger than those on the lower floors because of the reducing thickness of the structural walls on the upper floors.

因住宅物業的較高樓層的結構牆的厚度遞減，較高樓層的內部面積，一般比較低樓層的內部面積稍大。

Notes:

- The dimensions of floor plans are all structural dimensions in millimeter.
- There may be architectural features and/or exposed pipes on external walls of DOMUS. For details, please refer to the latest approved building plans.
- Common pipes exposed and/or enclosed in cladding are located at/adjacent to flat roof and/or external wall of DOMUS/Houses. For details, please refer to the latest approved building plans.
- There are ceiling bulkheads and/or sunken slab of the above Flats/Houses at living/dining room, bedrooms, corridors and/or kitchen of the above Flats/Houses for the air-conditioning system and/or mechanical and electrical services.
- Please refer to page 20 of this sales brochure for legend of the terms and abbreviations shown in the floor plan above.
- The air-conditioning outdoor unit is located at the Garden of the Flat.
- Under Special Condition No. (9)(g) of the Land Grant, the total number of residential units erected or to be erected on the Lot shall not be less than 170.
- According to Clause 55 of the Third Schedule to the DMC, no Owner shall demolish or alter the partition walls separating two Residential Units (as defined in the DMC) or a common wall dividing the land upon which two Houses (as defined in the DMC) are constructed or the floor slabs or roof slabs between two Residential Units which will result in such Residential Units being internally linked to and accessible from each other, except with the prior written consent of the Director of Lands or other Government authority in place of him from time to time.

備註:

- 平面圖所列之尺寸數字為以毫米標示之建築尺寸。
- 尚築及洋房外牆設有建築裝飾及/或外露喉管。詳細資料請參考最新批准之建築圖則。
- 尚築及洋房的平台及/或外牆設有外露及/或外牆裝飾板內藏之公用喉管。詳細資料請參考最新批准的建築圖則。
- 大樓及洋房客/飯廳、睡房、走廊及/或廚房有假天花及/或有跌級樓板以內藏冷氣系統及/或機電設備。
- 以上平面圖中顯示之名詞及簡稱請參閱本售樓書第20頁。
- 單位的分體式空調機的室外散熱機裝於單位的花園內。
- 批地文件特別條款第(9)(g)條規定，在該地段已建或擬建的住宅單位不得少於170個。
- 根據公契附表3第55條，除非已事先獲得地政總署署長或取代地政總署署長的其他政府機構不時作出的同意，否則任何業主不得拆卸或變更分隔兩個住宅單位(定義見公契)的間隔牆、分隔兩間洋房(定義見公契)土地的公用牆、或兩個住宅單位之間的水泥板或屋頂板以致使該等住宅單位能夠在內部連接及互通。

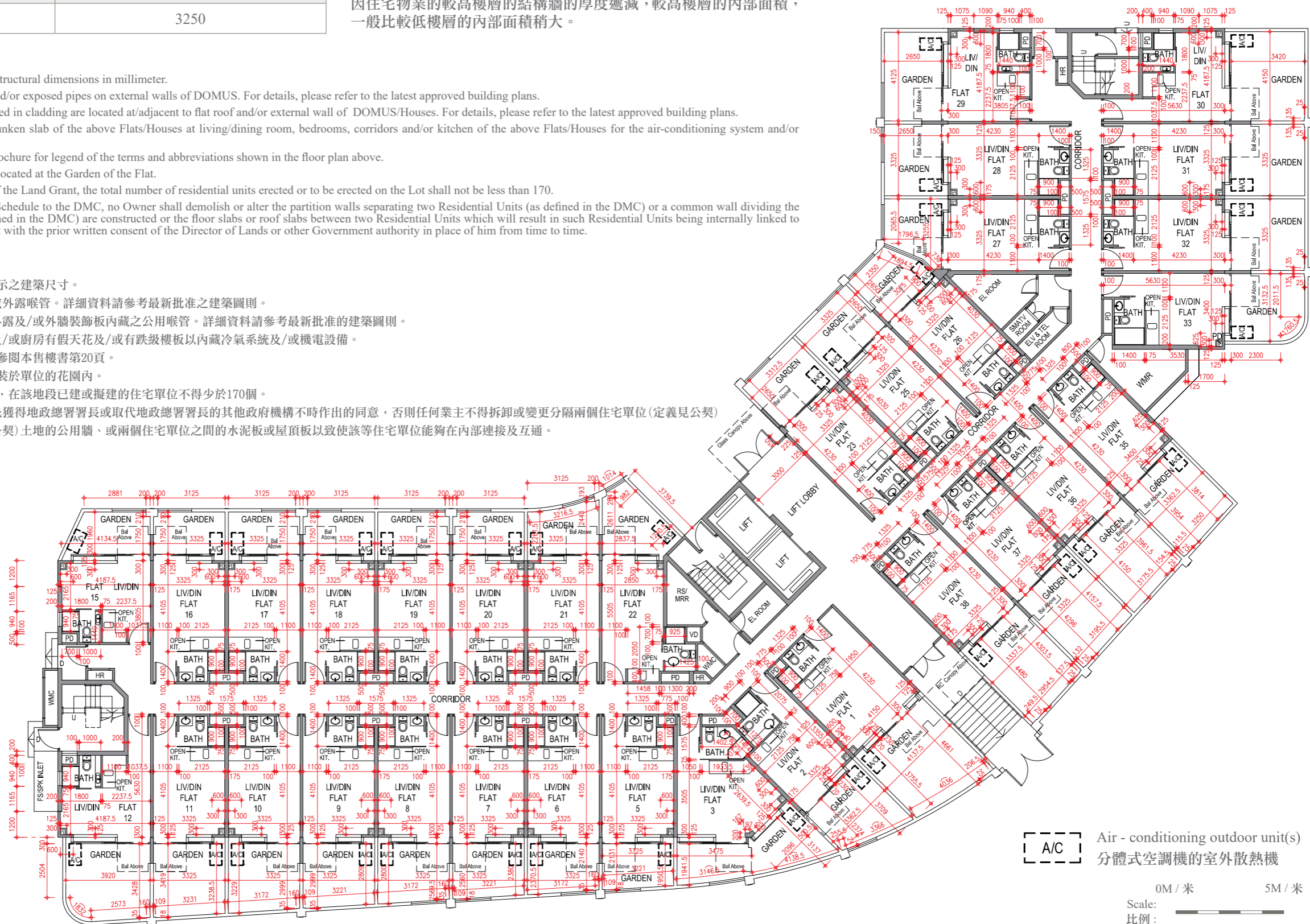

DOMUS 尚築

1/F Floor Plan 一樓平面圖



The thickness of the floor slabs (excluding plaster) (mm) 樓板(不包括灰泥)的厚度(毫米)	The floor-to-floor height (mm) 層與層之間的高度(毫米)
150	3050

The internal areas of the residential properties on the upper floors will generally be slightly larger than those on the lower floors because of the reducing thickness of the structural walls on the upper floors.
因住宅物業的較高樓層的結構牆的厚度遞減，較高樓層的內部面積，一般比較低樓層的內部面積稍大。

Notes:

- The dimensions of floor plans are all structural dimensions in millimeter.
- There may be architectural features and/or exposed pipes on external walls of DOMUS. For details, please refer to the latest approved building plans.
- Common pipes exposed and/or enclosed in cladding are located at/adjacent to flat roof and/or external wall of DOMUS/Houses. For details, please refer to the latest approved building plans.
- There are ceiling bulkheads and/or sunken slab of the above Flats/Houses at living/dining room, bedrooms, corridors and/or kitchen of the above Flats/Houses for the air-conditioning system and/or mechanical and electrical services.
- Please refer to page 20 of this sales brochure for legend of the terms and abbreviations shown in the floor plan above.
- The air - conditioning outdoor unit is located at the Roof of DOMUS.
- Under Special Condition No. (9)(g) of the Land Grant, the total number of residential units erected or to be erected on the Lot shall not be less than 170.
- According to Clause 55 of the Third Schedule to the DMC, no Owner shall demolish or alter the partition walls separating two Residential Units (as defined in the DMC) or a common wall dividing the land upon which two Houses (as defined in the DMC) are constructed or the floor slabs or roof slabs between two Residential Units which will result in such Residential Units being internally linked to and accessible from each other, except with the prior written consent of the Director of Lands or other Government authority in place of him from time to time.

備註:

- 平面圖所列之尺寸數字為以毫米標示之建築尺寸。
- 尚築及洋房外牆設有建築裝飾及/或外露喉管。詳細資料請參考最新批准之建築圖則。
- 尚築及洋房的平台及/或外牆設有外露及/或外牆裝飾板內藏之公用喉管。詳細資料請參考最新批准的建築圖則。
- 大樓及洋房客/飯廳、睡房、走廊及/或廚房有假天花及/或有跌級樓板以內藏冷氣系統及/或機電設備。
- 以上平面圖中顯示之名詞及簡稱請參閱本售樓書第20頁。
- 單位的分體式空調機的室外散熱機裝於尚築的天台。
- 批地文件特別條款第(9)(g)條規定，在該地段已建或擬建的住宅單位不得少於170個。
- 根據公契附表3第55條，除非已事先獲得地政總署署長或取代地政總署署長的其他政府機構不時作出的同意，否則任何業主不得拆卸或變更分隔兩個住宅單位(定義見公契)的間隔牆、分隔兩間洋房(定義見公契)土地的公用牆、或兩個住宅單位之間的水泥板或屋頂板以致使該等住宅單位能夠在內部連接及互通。

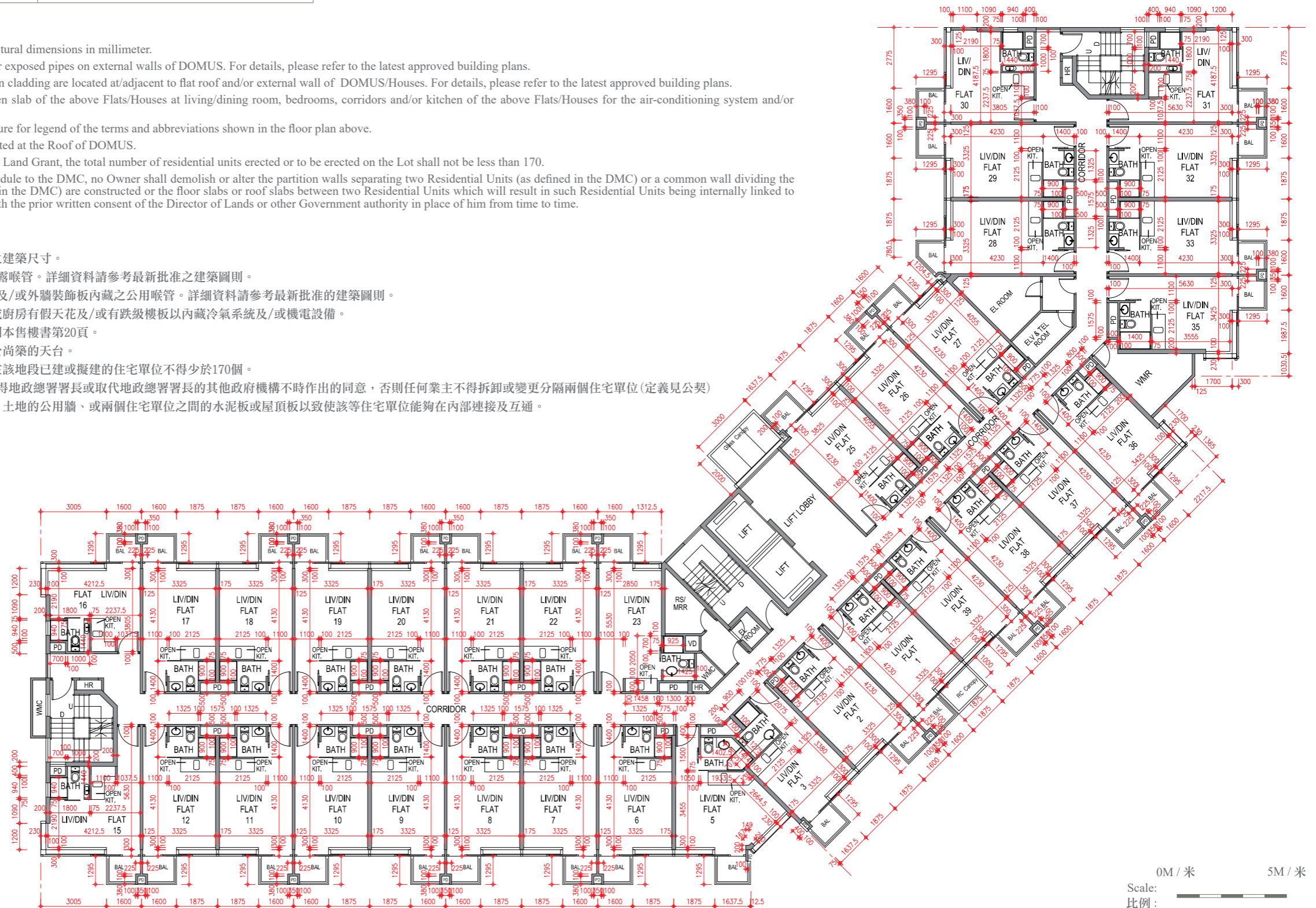

DOMUS 尚築

2/F Floor Plan 二樓平面圖



The thickness of the floor slabs (excluding plaster) (mm) 樓板(不包括灰泥)的厚度(毫米)	The floor-to-floor height (mm) 層與層之間的高度(毫米)
150	3050

The internal areas of the residential properties on the upper floors will generally be slightly larger than those on the lower floors because of the reducing thickness of the structural walls on the upper floors.

因住宅物業的較高樓層的結構牆的厚度遞減，較高樓層的內部面積，一般比較低樓層的內部面積稍大。

Notes:

- The dimensions of floor plans are all structural dimensions in millimeter.
- There may be architectural features and/or exposed pipes on external walls of DOMUS. For details, please refer to the latest approved building plans.
- Common pipes exposed and/or enclosed in cladding are located at/adjacent to flat roof and/or external wall of DOMUS/Houses. For details, please refer to the latest approved building plans.
- There are ceiling bulkheads and/or sunken slab of the above Flats/Houses at living/dining room, bedrooms, corridors and/or kitchen of the above Flats/Houses for the air-conditioning system and/or mechanical and electrical services.
- Please refer to page 20 of this sales brochure for legend of the terms and abbreviations shown in the floor plan above.
- The air - conditioning outdoor unit is located at the Roof of DOMUS.
- Under Special Condition No. (9)(g) of the Land Grant, the total number of residential units erected or to be erected on the Lot shall not be less than 170.
- According to Clause 55 of the Third Schedule to the DMC, no Owner shall demolish or alter the partition walls separating two Residential Units (as defined in the DMC) or a common wall dividing the land upon which two Houses (as defined in the DMC) are constructed or the floor slabs or roof slabs between two Residential Units which will result in such Residential Units being internally linked to and accessible from each other, except with the prior written consent of the Director of Lands or other Government authority in place of him from time to time.

備註：

- 平面圖所列之尺寸數字為以毫米標示之建築尺寸。
- 尚築及洋房外牆設有建築裝飾及/或外露喉管。詳細資料請參考最新批准之建築圖則。
- 尚築及洋房的平台及/或外牆設有外露及/或外牆裝飾板內藏之公用喉管。詳細資料請參考最新批准的建築圖則。
- 大樓及洋房客/飯廳、睡房、走廊及/或廚房有假天花及/或有跌級樓板以內藏冷氣系統及/或機電設備。
- 以上平面圖中顯示之名詞及簡稱請參閱本售樓書第20頁。
- 單位的分體式空調機的室外散熱機裝於尚築的天台。
- 批地文件特別條款第(9)(g)條規定，在該地段已建或擬建的住宅單位不得少於170個。
- 根據公契附表3第55條，除非已事先獲得地政總署署長或取代地政總署署長的其他政府機構不時作出的同意，否則任何業主不得拆卸或變更分隔兩個住宅單位(定義見公契)的間隔牆、分隔兩間洋房(定義見公契)土地之公用牆、或兩個住宅單位之間的水泥板或屋頂板以致使該等住宅單位能夠在內部連接及互通。

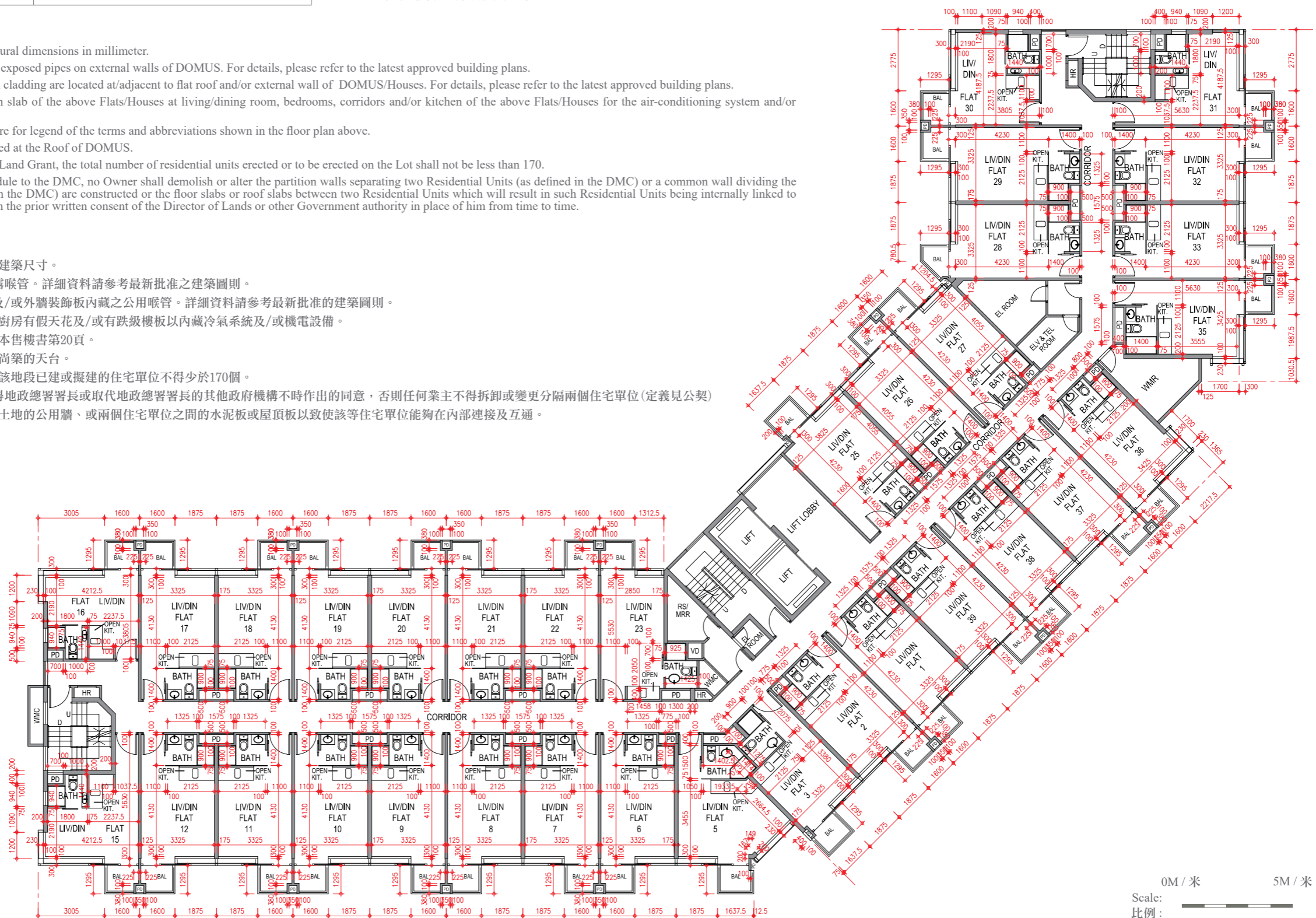

DOMUS 尚築

3/F Floor Plan 三樓平面圖



The thickness of the floor slabs (excluding plaster) (mm) 樓板(不包括灰泥)的厚度(毫米)	The floor-to-floor height (mm) 層與層之間的高度(毫米)
150	3050

The internal areas of the residential properties on the upper floors will generally be slightly larger than those on the lower floors because of the reducing thickness of the structural walls on the upper floors.
因住宅物業的較高樓層的結構牆的厚度遞減，較高樓層的內部面積，一般比較低樓層的內部面積稍大。

Notes:

- The dimensions of floor plans are all structural dimensions in millimeter.
- There may be architectural features and/or exposed pipes on external walls of DOMUS. For details, please refer to the latest approved building plans.
- Common pipes exposed and/or enclosed in cladding are located at/adjacent to flat roof and/or external wall of DOMUS/Houses. For details, please refer to the latest approved building plans.
- There are ceiling bulkheads and/or sunken slab of the above Flats/Houses at living/dining room, bedrooms, corridors and/or kitchen of the above Flats/Houses for the air-conditioning system and/or mechanical and electrical services.
- Please refer to page 20 of this sales brochure for legend of the terms and abbreviations shown in the floor plan above.
- The air - conditioning outdoor unit is located at the Roof of DOMUS.
- Under Special Condition No. (9)(g) of the Land Grant, the total number of residential units erected or to be erected on the Lot shall not be less than 170.
- According to Clause 55 of the Third Schedule to the DMC, no Owner shall demolish or alter the partition walls separating two Residential Units (as defined in the DMC) or a common wall dividing the land upon which two Houses (as defined in the DMC) are constructed or the floor slabs or roof slabs between two Residential Units which will result in such Residential Units being internally linked to and accessible from each other, except with the prior written consent of the Director of Lands or other Government authority in place of him from time to time.

備註:

- 平面圖所列之尺寸數字為以毫米標示之建築尺寸。
- 尚築及洋房外牆設有建築裝飾及/或外露喉管。詳細資料請參考最新批准之建築圖則。
- 尚築及洋房的平台及/或外牆設有外露及/或外牆裝飾板內藏之公用喉管。詳細資料請參考最新批准的建築圖則。
- 大樓及洋房客/飯廳、睡房、走廊及/或廚房有假天花及/或有跌級樓板以內藏冷氣系統及/或機電設備。
- 以上平面圖中顯示之名詞及簡稱請參閱本售樓書第20頁。
- 單位的分體式空調機的室外散熱機裝於尚築的天台。
- 批地文件特別條款第(9)(g)條規定，在該地段已建或擬建的住宅單位不得少於170個。
- 根據公契附表3第55條，除非已事先獲得地政總署署長或取代地政總署署長的其他政府機構不時作出的同意，否則任何業主不得拆卸或變更分隔兩個住宅單位(定義見公契)的間隔牆、分隔兩間洋房(定義見公契)土地的公用牆、或兩個住宅單位之間的水泥板或屋頂板以致使該等住宅單位能夠在內部連接及互通。

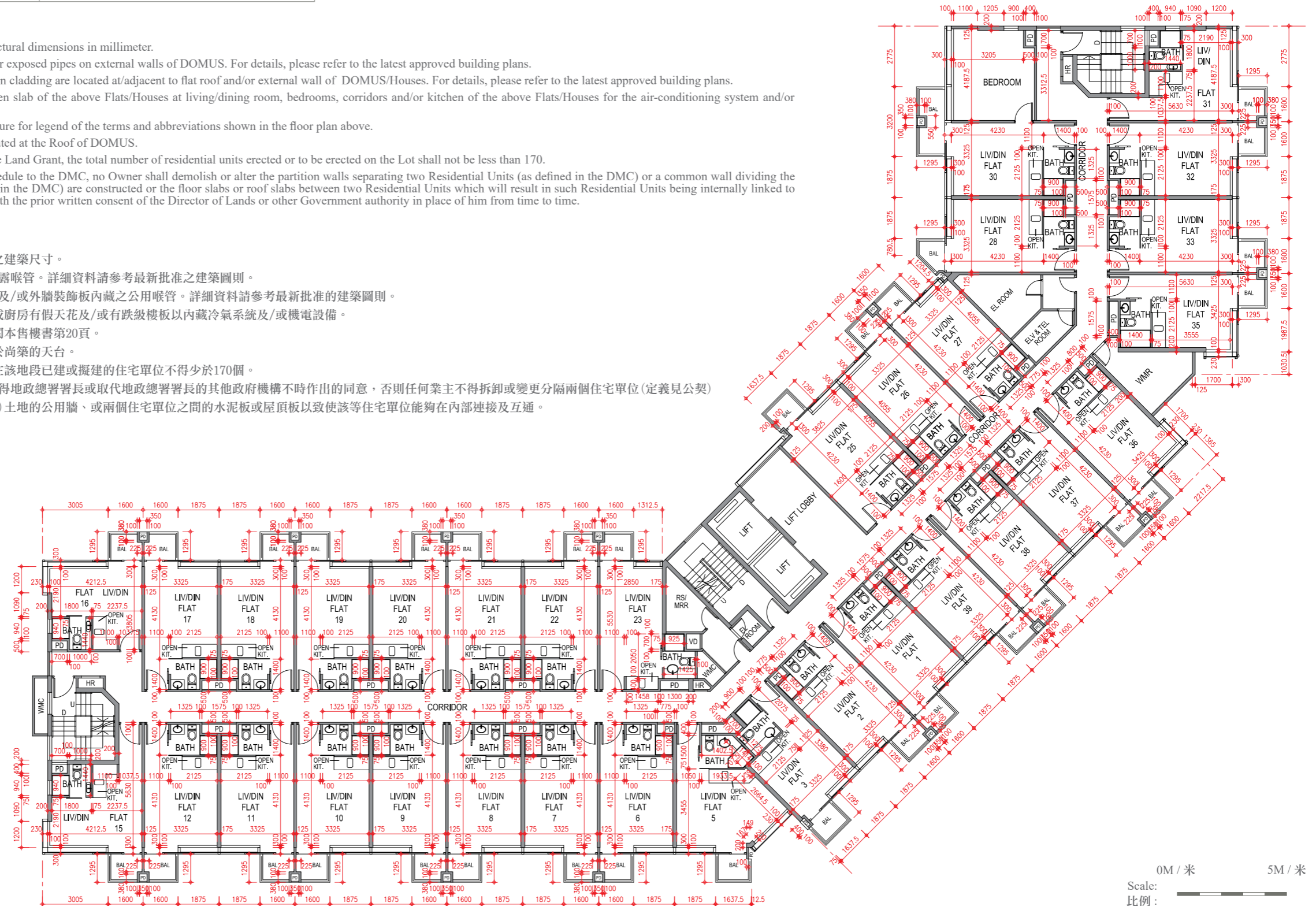

67A Tan Kwai Tsuen Road, Casa Regalia 富豪·悦庭丹桂村路 67A 號

Floor 樓層	The thickness of the floor slabs (excluding plaster) of each House (mm) 每座洋房的樓板(不包括灰泥)的厚度(毫米)	The floor-to-floor height of each House (mm) 每座洋房的層與層之間的高度(毫米)
Basement 地下樓層	-	3600
G/F 地下	150, 175	4200
1/F 一樓	150, 175	3400
2/F 二樓	150, 175	3400
Roof 天台	150, 175	2825

The internal areas of the residential properties on the upper floors will generally be slightly larger than those on the lower floors because of the reducing thickness of the structural walls on the upper floors.

因住宅物業的較高樓層的結構牆的厚度遞減，較高樓層的內部面積，一般比較低樓層的內部面積稍大。

Notes:

- The dimensions of floor plans are all structural dimensions in millimeter.
- There may be architectural features and/or exposed pipes on external walls of DOMUS/Houses. For details, please refer to the latest approved building plans.
- Common pipes exposed and/or enclosed in cladding are located at/adjacent to flat roof and/or external wall of DOMUS/Houses. For details, please refer to the latest approved building plans.
- There are ceiling bulkheads and/or sunken slab of the above Flats/Houses at living/dining room, bedrooms, corridors and/or kitchen of the above Flats/Houses for the air-conditioning system and/or mechanical and electrical services.
- Please refer to page 20 of this sales brochure for legend of the terms and abbreviations shown in the floor plan above.
- Under Special Condition No. (9)(g) of the Land Grant, the total number of residential units erected or to be erected on the Lot shall not be less than 170.
- According to Clause 55 of the Third Schedule to the DMC, no Owner shall demolish or alter the partition walls separating two Residential Units (as defined in the DMC) or a common wall dividing the land upon which two Houses (as defined in the DMC) are constructed or the floor slabs or roof slabs between two Residential Units which will result in such Residential Units being internally linked to and accessible from each other, except with the prior written consent of the Director of Lands or other Government authority in place of him from time to time.

備註：

- 平面圖所列之尺寸數字為以毫米標示之建築尺寸。
- 尚築及洋房外牆設有建築裝飾及/或外露喉管。詳細資料請參考最新批准之建築圖則。
- 尚築及洋房的平台及/或外牆設有外露及/或外牆裝飾板內藏之公用喉管。詳細資料請參考最新批准的建築圖則。
- 大樓及洋房客/飯廳、睡房、走廊及/或廚房有假天花及/或有跌級樓板以內藏冷氣系統及/或機電設備。
- 以上平面圖中顯示之名詞及簡稱請參閱本售樓書第20頁。
- 批地文件特別條款第(9)(g)條規定，在該地段已建或擬建的住宅單位不得少於170個。
- 根據公契附表3第55條，除非已事先獲得地政總署署長或取代地政總署署長的其他政府機構不時作出的同意，否則任何業主不得拆卸或變更分隔兩個住宅單位(定義見公契)的間隔牆、分隔兩間洋房(定義見公契)土地的公用牆、或兩個住宅單位之間的水泥板或屋頂板以致使該等住宅單位能夠在內部連接及互通。

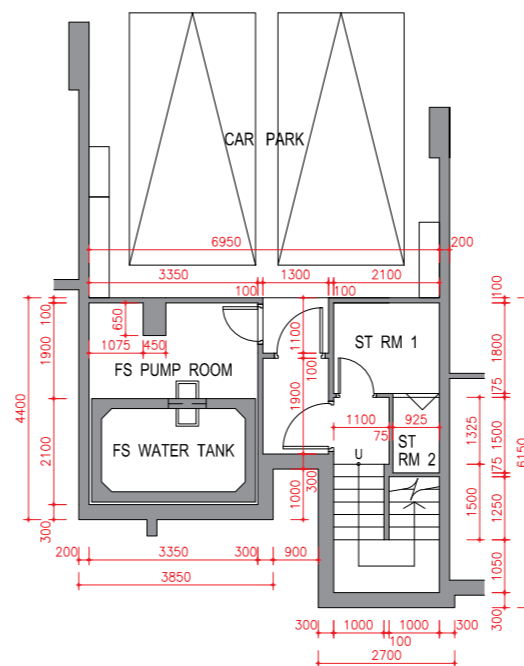

Basement Plan
地庫平面圖

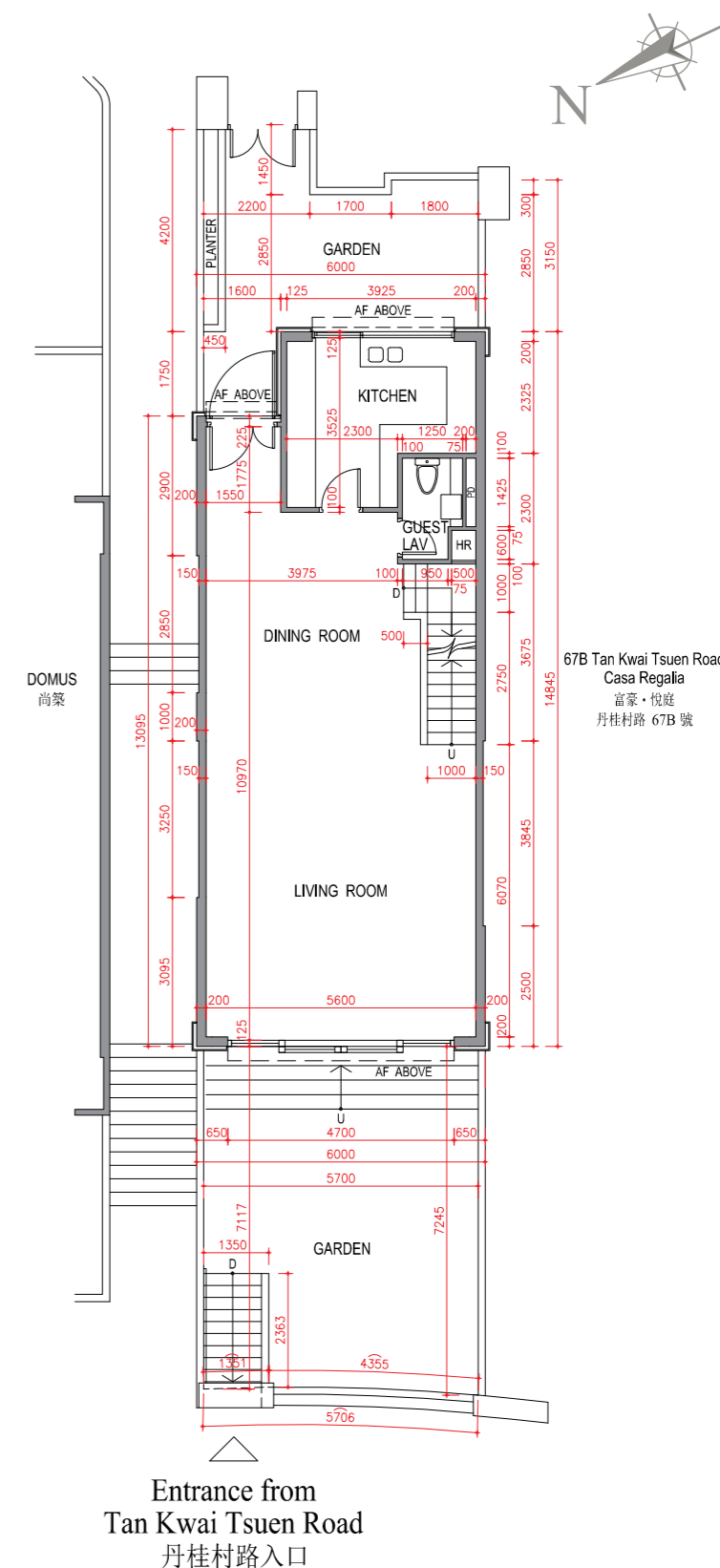

Entrance from
Tan Kwai Tsuen Road
丹桂村路入口

G/F Plan
地面層平面圖

0M / 米 5M / 米
Scale:
比例:

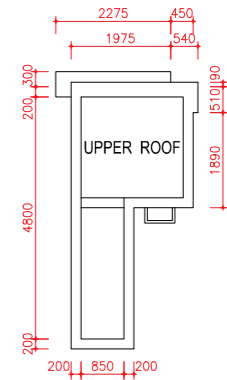
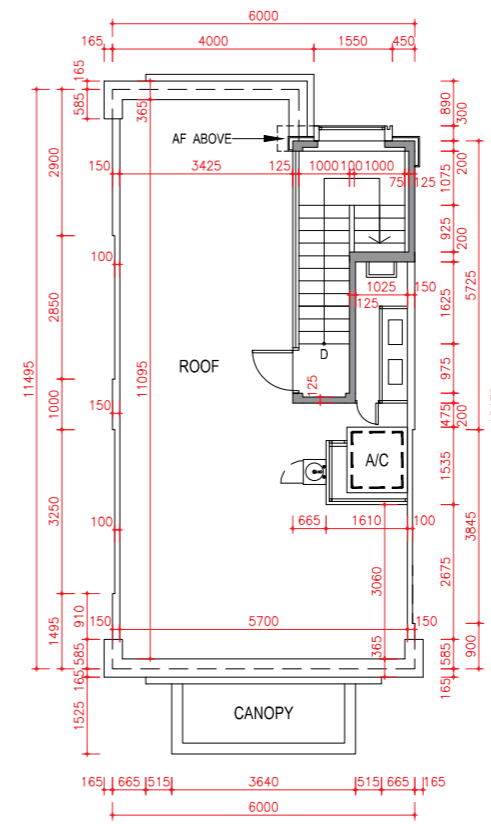
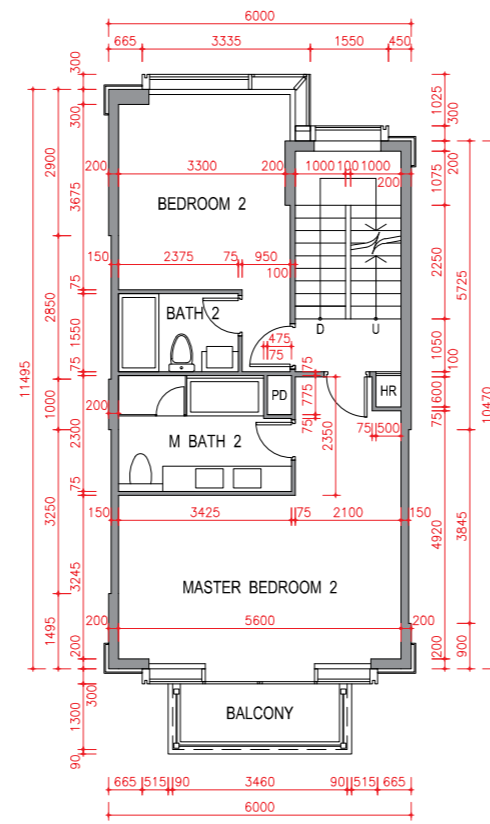
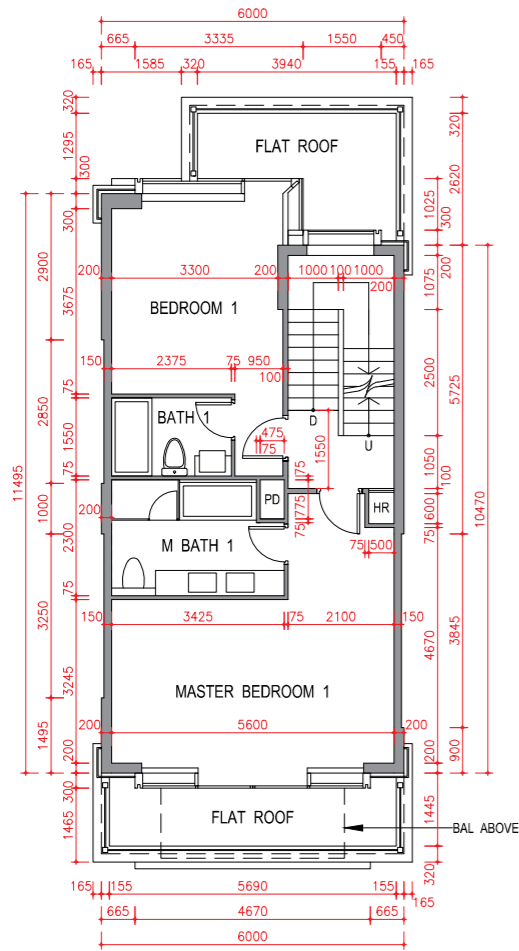
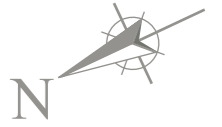

Upper Roof Plan
上層天台平面圖

67B Tan Kwai Tsuen Road, Casa Regalia 富豪·悅庭丹桂村路 67B 號



Floor 樓層	The thickness of the floor slabs (excluding plaster) of each House (mm) 每座洋房的樓板(不包括灰泥)的厚度(毫米)	The floor-to-floor height of each House (mm) 每座洋房的層與層之間的高度(毫米)
Basement 地下樓層	-	3600
G/F 地下	150, 175	4200
1/F 一樓	150, 175	3400
2/F 二樓	150, 175	3400
Roof 天台	150, 175	2825

The internal areas of the residential properties on the upper floors will generally be slightly larger than those on the lower floors because of the reducing thickness of the structural walls on the upper floors.

因住宅物業的較高樓層的結構牆的厚度遞減，較高樓層的內部面積，一般比較低樓層的內部面積稍大。

Notes:

- The dimensions of floor plans are all structural dimensions in millimeter.
- There may be architectural features and/or exposed pipes on external walls of DOMUS/Houses. For details, please refer to the latest approved building plans.
- Common pipes exposed and/or enclosed in cladding are located at/adjacent to flat roof and/or external wall of DOMUS/Houses. For details, please refer to the latest approved building plans.
- There are ceiling bulkheads and/or sunken slab of the above Flats/Houses at living/dining room, bedrooms, corridors and/or kitchen of the above Flats/Houses for the air-conditioning system and/or mechanical and electrical services.
- Please refer to page 20 of this sales brochure for legend of the terms and abbreviations shown in the floor plan above.
- Under Special Condition No. (9)(g) of the Land Grant, the total number of residential units erected or to be erected on the Lot shall not be less than 170.
- According to Clause 55 of the Third Schedule to the DMC, no Owner shall demolish or alter the partition walls separating two Residential Units (as defined in the DMC) or a common wall dividing the land upon which two Houses (as defined in the DMC) are constructed or the floor slabs or roof slabs between two Residential Units which will result in such Residential Units being internally linked to and accessible from each other, except with the prior written consent of the Director of Lands or other Government authority in place of him from time to time.

備註：

- 平面圖所列之尺寸數字為以毫米標示之建築尺寸。
- 尚築及洋房外牆設有建築裝飾及/或外露喉管。詳細資料請參考最新批准之建築圖則。
- 尚築及洋房的平台及/或外牆設有外露及/或外牆裝飾板內藏之公用喉管。詳細資料請參考最新批准的建築圖則。
- 大樓及洋房客/飯廳、睡房、走廊及/或廚房有假天花及/或有跌級樓板以內藏冷氣系統及/或機電設備。
- 以上平面圖中顯示之名詞及簡稱請參閱本售樓書第20頁。
- 批地文件特別條款第(9)(g)條規定，在該地段已建或擬建的住宅單位不得少於170個。
- 根據公契附表3第55條，除非已事先獲得地政總署署長或取代地政總署署長的其他政府機構不時作出的同意，否則任何業主不得拆卸或變更分隔兩個住宅單位(定義見公契)的間隔牆、分隔兩間洋房(定義見公契)土地的公用牆、或兩個住宅單位之間的水泥板或屋頂板以致使該等住宅單位能夠在內部連接及互通。

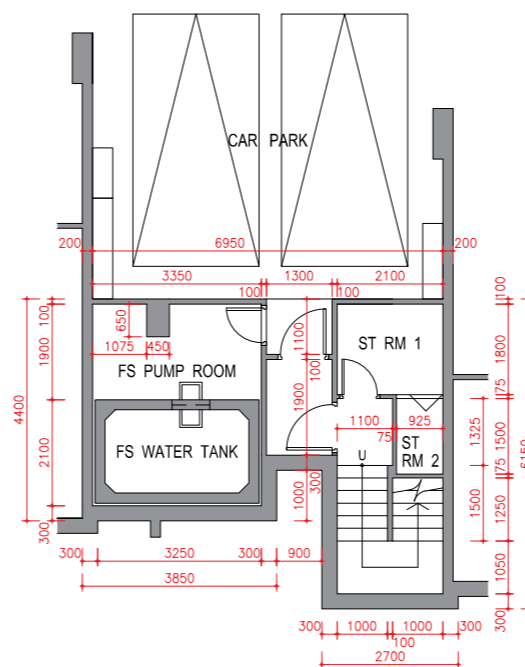

Basement Plan
地庫平面圖

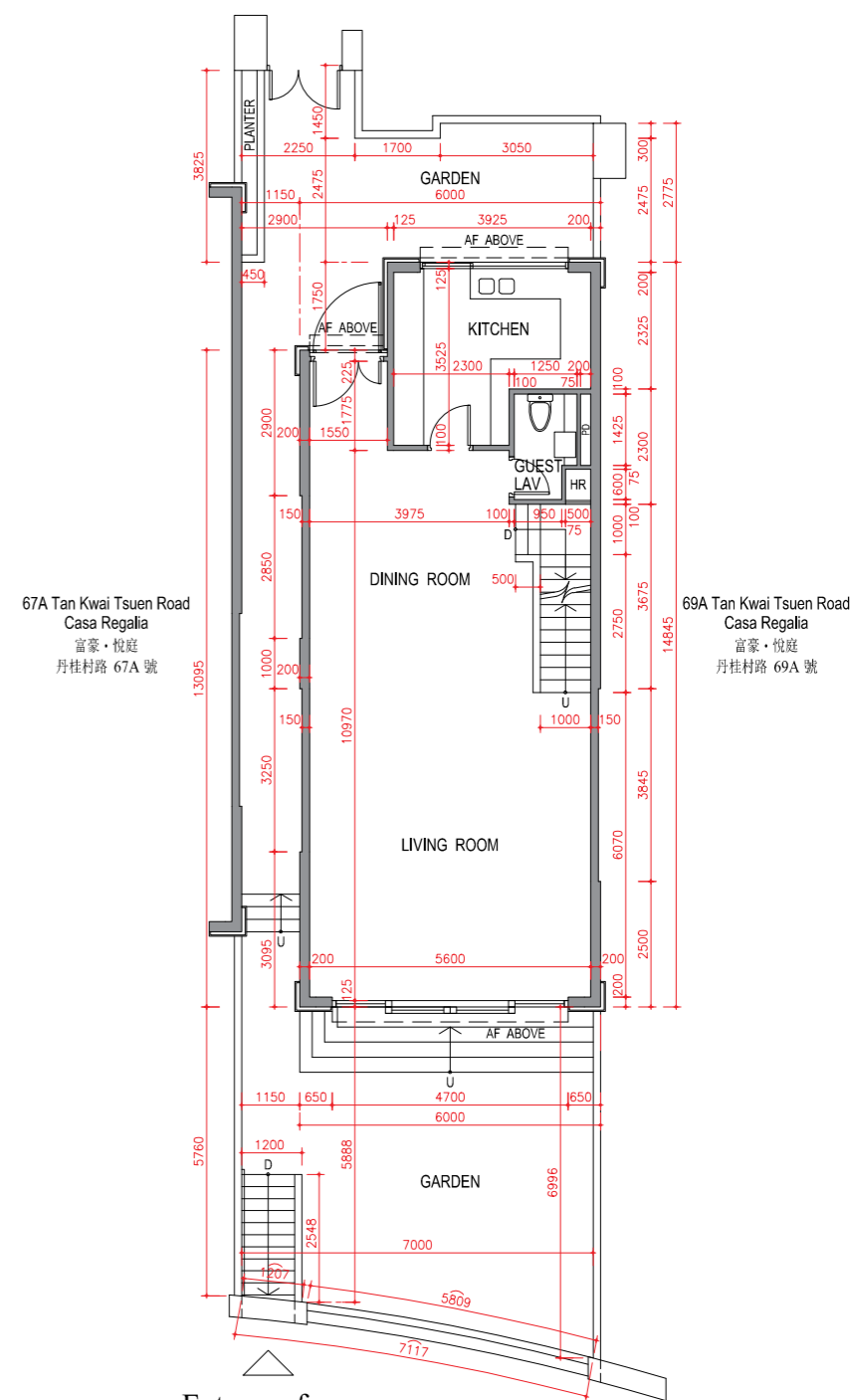

Entrance from
Tan Kwai Tsuen Road
丹桂村路入口

G/F Plan
地面層平面圖

Scale: 0M / 米 5M / 米
比例:

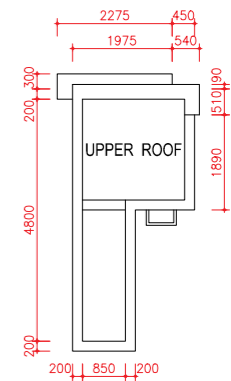
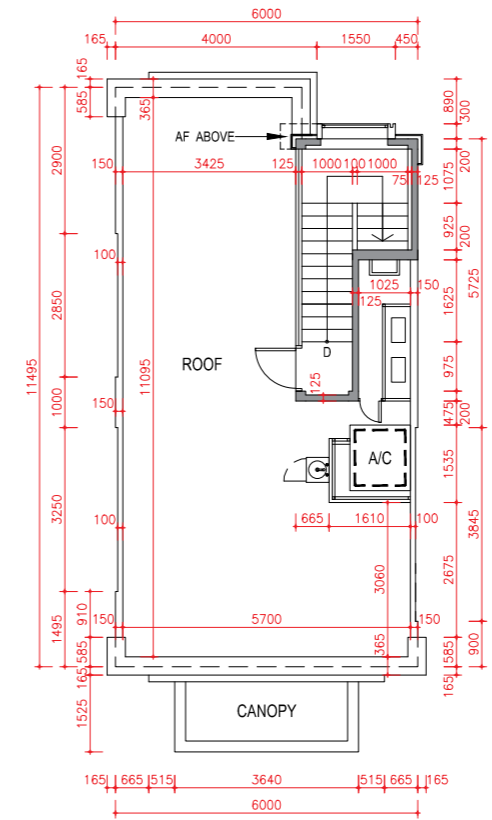
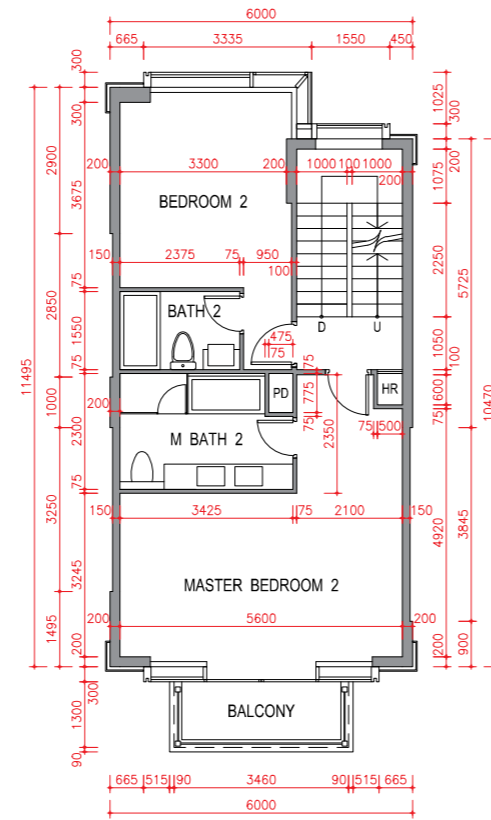
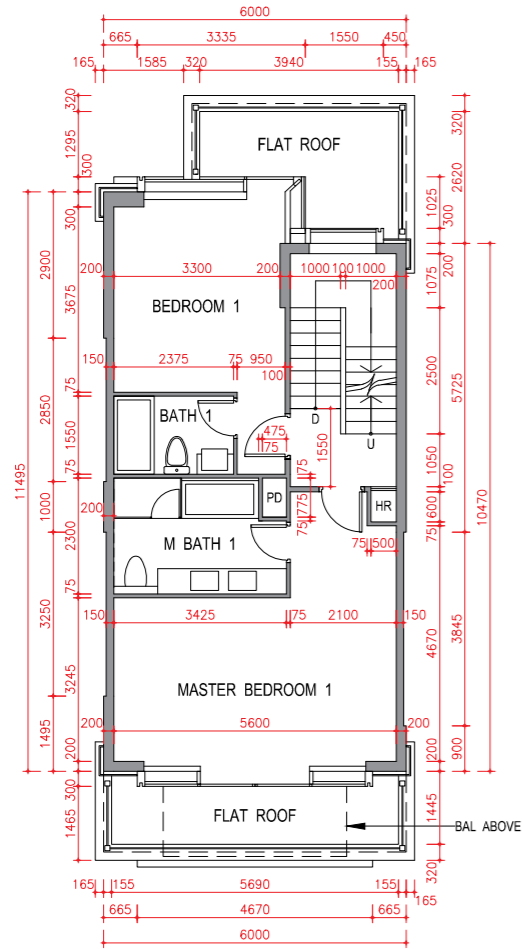
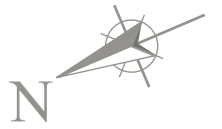

Upper Roof Plan
上層天台平面圖

69A Tan Kwai Tsuen Road, Casa Regalia 富豪·悦庭丹桂村路 69A 號

Floor 樓層	The thickness of the floor slabs (excluding plaster) of each House (mm) 每座洋房的樓板(不包括灰泥)的厚度(毫米)	The floor-to-floor height of each House (mm) 每座洋房的層與層之間的高度(毫米)
Basement 地下樓層	-	3600
G/F 地下	150, 175	4200
1/F 一樓	150, 175	3400
2/F 二樓	150, 175	3400
Roof 天台	150, 175	2825

The internal areas of the residential properties on the upper floors will generally be slightly larger than those on the lower floors because of the reducing thickness of the structural walls on the upper floors.

因住宅物業的較高樓層的結構牆的厚度遞減，較高樓層的內部面積，一般比較低樓層的內部面積稍大。

Notes:

- The dimensions of floor plans are all structural dimensions in millimeter.
- There may be architectural features and/or exposed pipes on external walls of DOMUS/Houses. For details, please refer to the latest approved building plans.
- Common pipes exposed and/or enclosed in cladding are located at/adjacent to flat roof and/or external wall of DOMUS/Houses. For details, please refer to the latest approved building plans.
- There are ceiling bulkheads and/or sunken slab of the above Flats/Houses at living/dining room, bedrooms, corridors and/or kitchen of the above Flats/Houses for the air-conditioning system and/or mechanical and electrical services.
- Please refer to page 20 of this sales brochure for legend of the terms and abbreviations shown in the floor plan above.
- Under Special Condition No. (9)(g) of the Land Grant, the total number of residential units erected or to be erected on the Lot shall not be less than 170.
- According to Clause 55 of the Third Schedule to the DMC, no Owner shall demolish or alter the partition walls separating two Residential Units (as defined in the DMC) or a common wall dividing the land upon which two Houses (as defined in the DMC) are constructed or the floor slabs or roof slabs between two Residential Units which will result in such Residential Units being internally linked to and accessible from each other, except with the prior written consent of the Director of Lands or other Government authority in place of him from time to time.

備註：

- 平面圖所列之尺寸數字為以毫米標示之建築尺寸。
- 尚築及洋房外牆設有建築裝飾及/或外露喉管。詳細資料請參考最新批准之建築圖則。
- 尚築及洋房的平台及/或外牆設有外露及/或外牆裝飾板內藏之公用喉管。詳細資料請參考最新批准的建築圖則。
- 大樓及洋房客/飯廳、睡房、走廊及/或廚房有假天花及/或有跌級樓板以內藏冷氣系統及/或機電設備。
- 以上平面圖中顯示之名詞及簡稱請參閱本售樓書第20頁。
- 批地文件特別條款第(9)(g)條規定，在該地段已建或擬建的住宅單位不得少於170個。
- 根據公契附表3第55條，除非已事先獲得地政總署署長或取代地政總署署長的其他政府機構不時作出的同意，否則任何業主不得拆卸或變更分隔兩個住宅單位(定義見公契)的間隔牆、分隔兩間洋房(定義見公契)土地的公用牆、或兩個住宅單位之間的水泥板或屋頂板以致使該等住宅單位能夠在內部連接及互通。

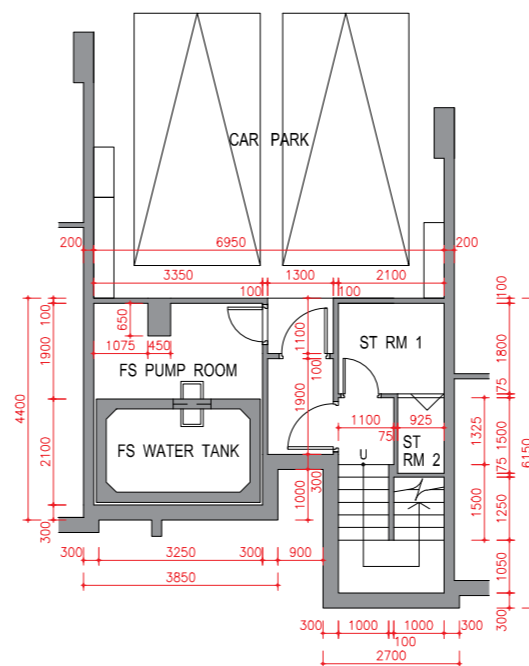

Basement Plan
地庫平面圖

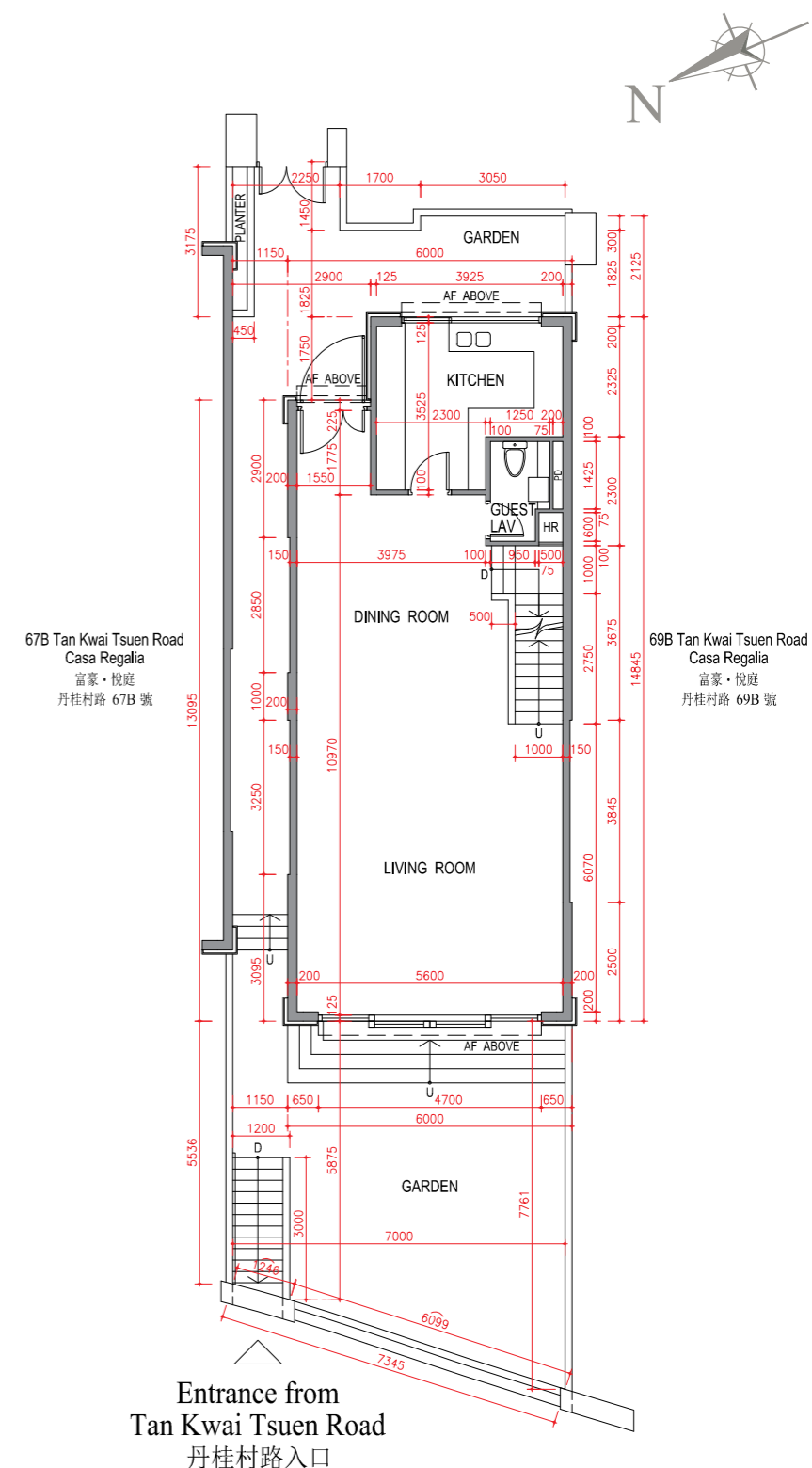

G/F Plan
地面層平面圖

Scale: 0M / 米 5M / 米
比例:

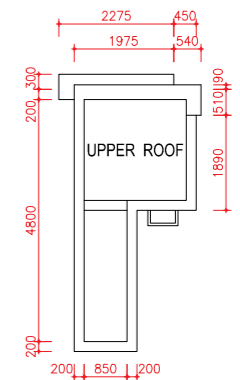
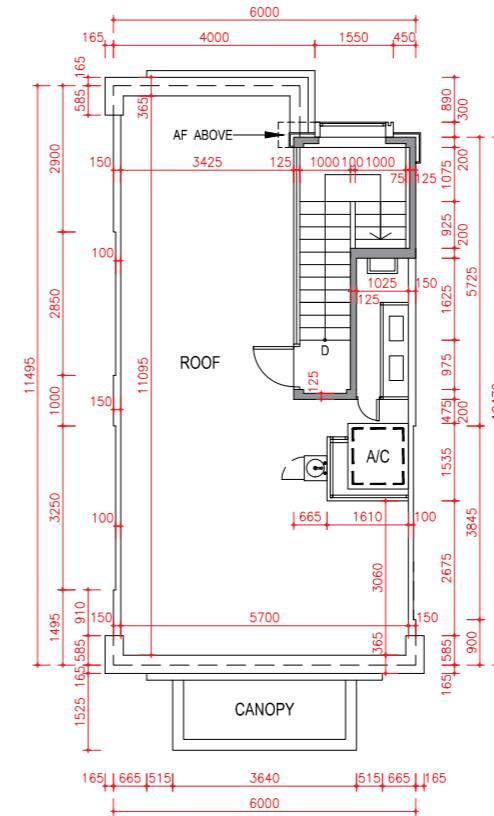
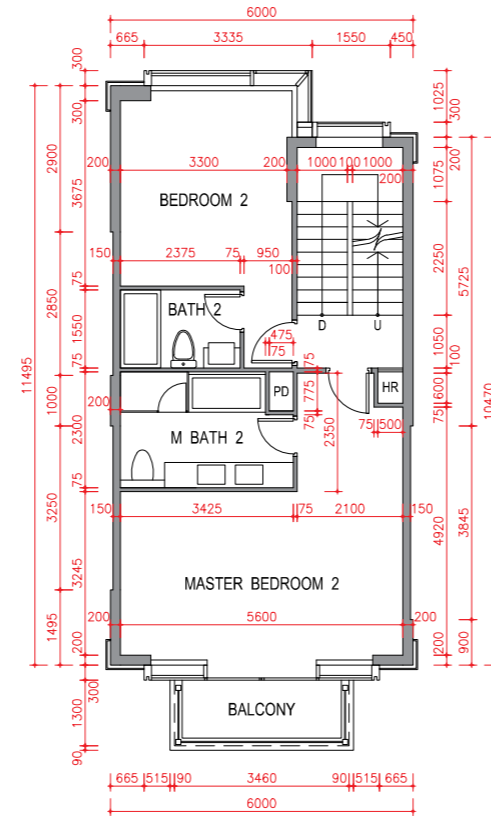
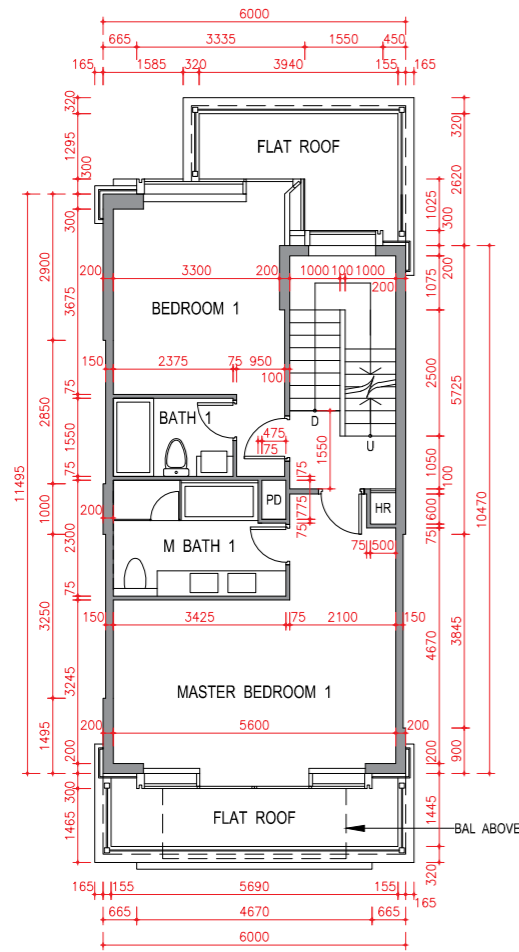
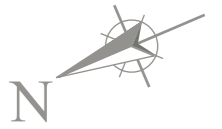

Upper Roof Plan
上層天台平面圖

69B Tan Kwai Tsuen Road, Casa Regalia 富豪·悅庭丹桂村路 69B 號

Floor 樓層	The thickness of the floor slabs (excluding plaster) of each House (mm) 每座洋房的樓板(不包括灰泥)的厚度(毫米)	The floor-to-floor height of each House (mm) 每座洋房的層與層之間的高度(毫米)
Basement 地下樓層	-	3600
G/F 地下	150, 175	4200
1/F 一樓	150, 175	3400
2/F 二樓	150, 175	3400
Roof 天台	150, 175	2825

The internal areas of the residential properties on the upper floors will generally be slightly larger than those on the lower floors because of the reducing thickness of the structural walls on the upper floors.

因住宅物業的較高樓層的結構牆的厚度遞減，較高樓層的內部面積，一般比較低樓層的內部面積稍大。

Notes:

- The dimensions of floor plans are all structural dimensions in millimeter.
- There may be architectural features and/or exposed pipes on external walls of DOMUS/Houses. For details, please refer to the latest approved building plans.
- Common pipes exposed and/or enclosed in cladding are located at/adjacent to flat roof and/or external wall of DOMUS/Houses. For details, please refer to the latest approved building plans.
- There are ceiling bulkheads and/or sunken slab of the above Flats/Houses at living/dining room, bedrooms, corridors and/or kitchen of the above Flats/Houses for the air-conditioning system and/or mechanical and electrical services.
- Please refer to page 20 of this sales brochure for legend of the terms and abbreviations shown in the floor plan above.
- Under Special Condition No. (9)(g) of the Land Grant, the total number of residential units erected or to be erected on the Lot shall not be less than 170.
- According to Clause 55 of the Third Schedule to the DMC, no Owner shall demolish or alter the partition walls separating two Residential Units (as defined in the DMC) or a common wall dividing the land upon which two Houses (as defined in the DMC) are constructed or the floor slabs or roof slabs between two Residential Units which will result in such Residential Units being internally linked to and accessible from each other, except with the prior written consent of the Director of Lands or other Government authority in place of him from time to time.

備註：

- 平面圖所列之尺寸數字為以毫米標示之建築尺寸。
- 尚築及洋房外牆設有建築裝飾及/或外露喉管。詳細資料請參考最新批准之建築圖則。
- 尚築及洋房的平台及/或外牆設有外露及/或外牆裝飾板內藏之公用喉管。詳細資料請參考最新批准的建築圖則。
- 大樓及洋房客/飯廳、睡房、走廊及/或廚房有假天花及/或有跌級樓板以內藏冷氣系統及/或機電設備。
- 以上平面圖中顯示之名詞及簡稱請參閱本售樓書第20頁。
- 批地文件特別條款第(9)(g)條規定，在該地段已建或擬建的住宅單位不得少於170個。
- 根據公契附表3第55條，除非已事先獲得地政總署署長或取代地政總署署長的其他政府機構不時作出的同意，否則任何業主不得拆卸或變更分隔兩個住宅單位(定義見公契)的間隔牆、分隔兩間洋房(定義見公契)土地的公用牆、或兩個住宅單位之間的水泥板或屋頂板以致使該等住宅單位能夠在內部連接及互通。

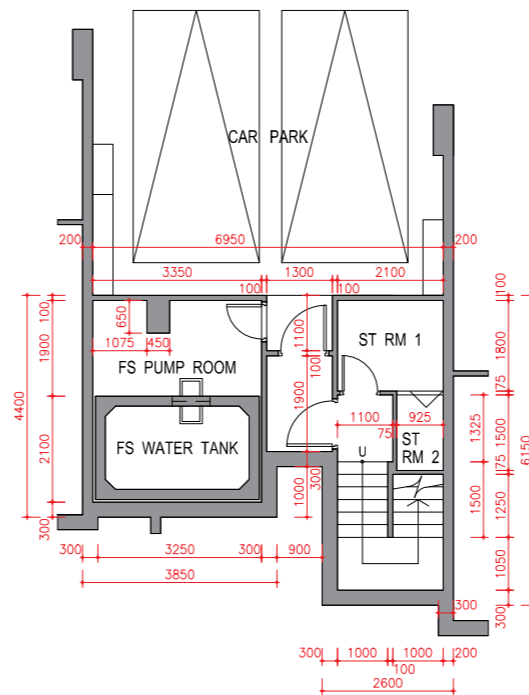

Basement Plan
地庫平面圖

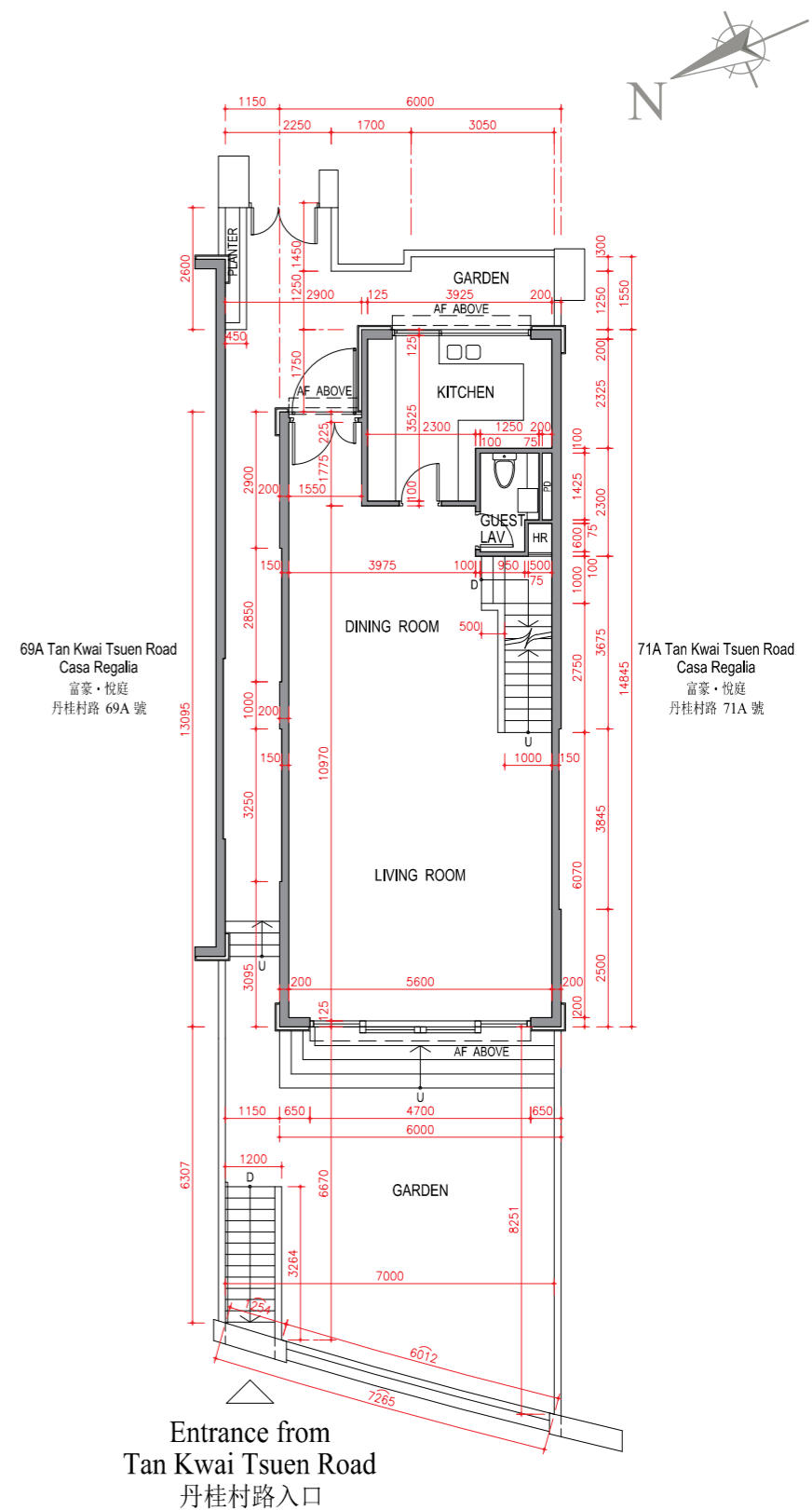

G/F Plan
地面層平面圖

Scale: 0M / 米 5M / 米
比例:

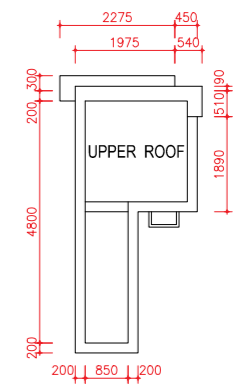
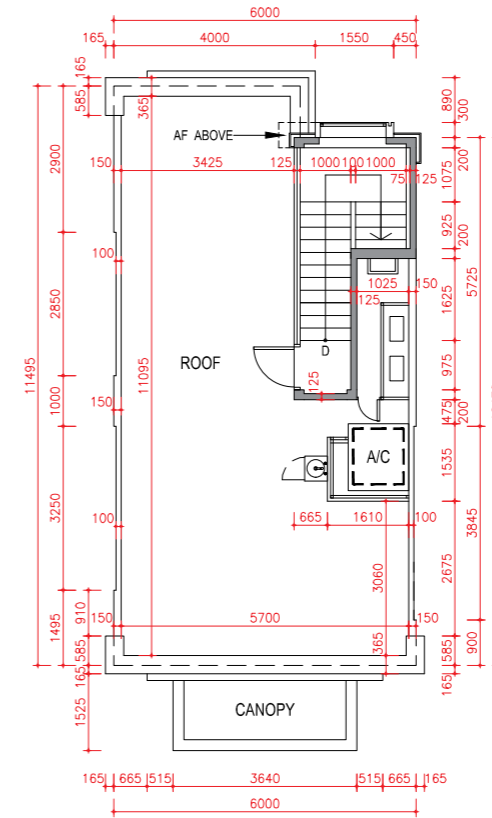
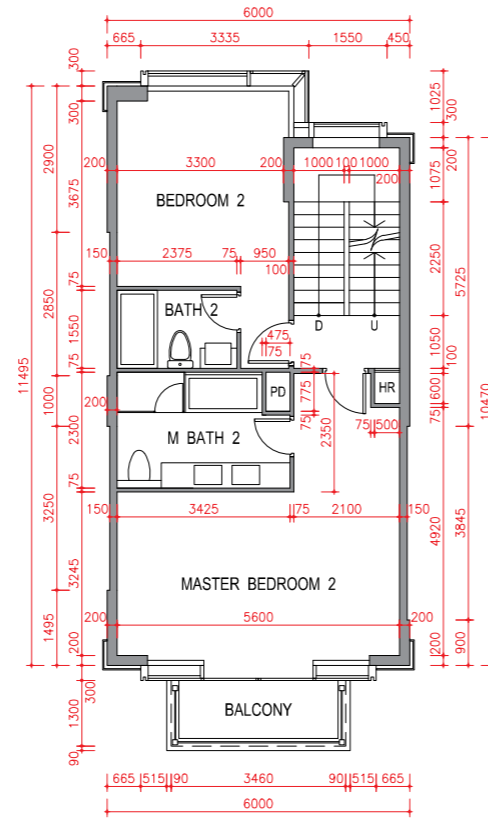
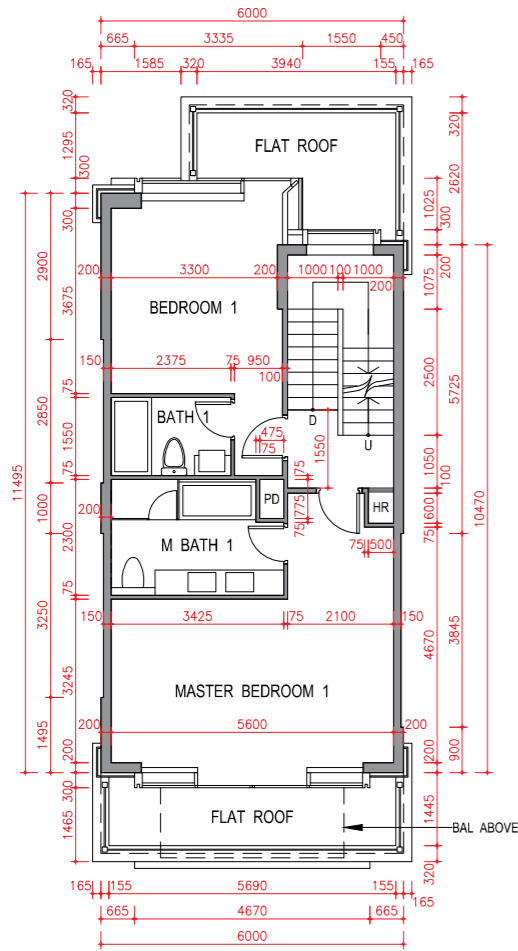
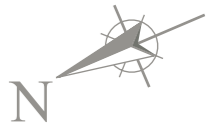

Upper Roof Plan
上層天台平面圖

71A Tan Kwai Tsuen Road, Casa Regalia 富豪·悅庭丹桂村路 71A 號

Floor 樓層	The thickness of the floor slabs (excluding plaster) of each House (mm) 每座洋房的樓板(不包括灰泥)的厚度(毫米)	The floor-to-floor height of each House (mm) 每座洋房的層與層之間的高度(毫米)
Basement 地下樓層	-	3650
G/F 地下	150, 175	4150
1/F 一樓	150, 175	3400
2/F 二樓	150, 175	3400
Roof 天台	150, 175	2825

The internal areas of the residential properties on the upper floors will generally be slightly larger than those on the lower floors because of the reducing thickness of the structural walls on the upper floors.

因住宅物業的較高樓層的結構牆的厚度遞減，較高樓層的內部面積，一般比較低樓層的內部面積稍大。

Notes:

- The dimensions of floor plans are all structural dimensions in millimeter.
- There may be architectural features and/or exposed pipes on external walls of DOMUS/Houses. For details, please refer to the latest approved building plans.
- Common pipes exposed and/or enclosed in cladding are located at/adjacent to flat roof and/or external wall of DOMUS/Houses. For details, please refer to the latest approved building plans.
- There are ceiling bulkheads and/or sunken slab of the above Flats/Houses at living/dining room, bedrooms, corridors and/or kitchen of the above Flats/Houses for the air-conditioning system and/or mechanical and electrical services.
- Please refer to page 20 of this sales brochure for legend of the terms and abbreviations shown in the floor plan above.
- Under Special Condition No. (9)(g) of the Land Grant, the total number of residential units erected or to be erected on the Lot shall not be less than 170.
- According to Clause 55 of the Third Schedule to the DMC, no Owner shall demolish or alter the partition walls separating two Residential Units (as defined in the DMC) or a common wall dividing the land upon which two Houses (as defined in the DMC) are constructed or the floor slabs or roof slabs between two Residential Units which will result in such Residential Units being internally linked to and accessible from each other, except with the prior written consent of the Director of Lands or other Government authority in place of him from time to time.

備註：

- 平面圖所列之尺寸數字為以毫米標示之建築尺寸。
- 尚築及洋房外牆設有建築裝飾及/或外露喉管。詳細資料請參考最新批准之建築圖則。
- 尚築及洋房的平台及/或外牆設有外露及/或外牆裝飾板內藏之公用喉管。詳細資料請參考最新批准的建築圖則。
- 大樓及洋房客/飯廳、睡房、走廊及/或廚房有假天花及/或有跌級樓板以內藏冷氣系統及/或機電設備。
- 以上平面圖中顯示之名詞及簡稱請參閱本售樓書第20頁。
- 批地文件特別條款第(9)(g)條規定，在該地段已建或擬建的住宅單位不得少於170個。
- 根據公契附表3第55條，除非已事先獲得地政總署署長或取代地政總署署長的其他政府機構不時作出的同意，否則任何業主不得拆卸或變更分隔兩個住宅單位(定義見公契)的間隔牆、分隔兩間洋房(定義見公契)土地的公用牆、或兩個住宅單位之間的水泥板或屋頂板以致使該等住宅單位能夠在內部連接及互通。

Remark:

Alterations have been made to 71A Tan Kwai Tsuen Road, Casa Regalia, please refer to the "as-is" layout plans on Pages 34A and 34B for such alterations.

備註：

富豪·悅庭丹桂村路71A號經過改動，有關改動請參閱第34A及34B頁之現狀平面圖。

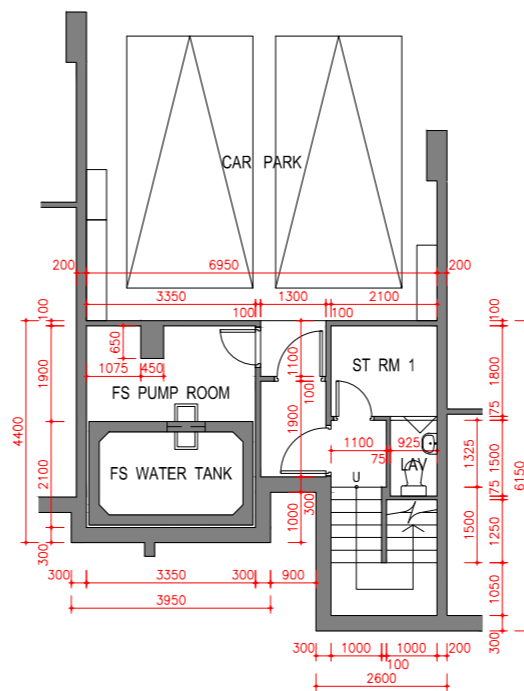

Basement Plan
地庫平面圖

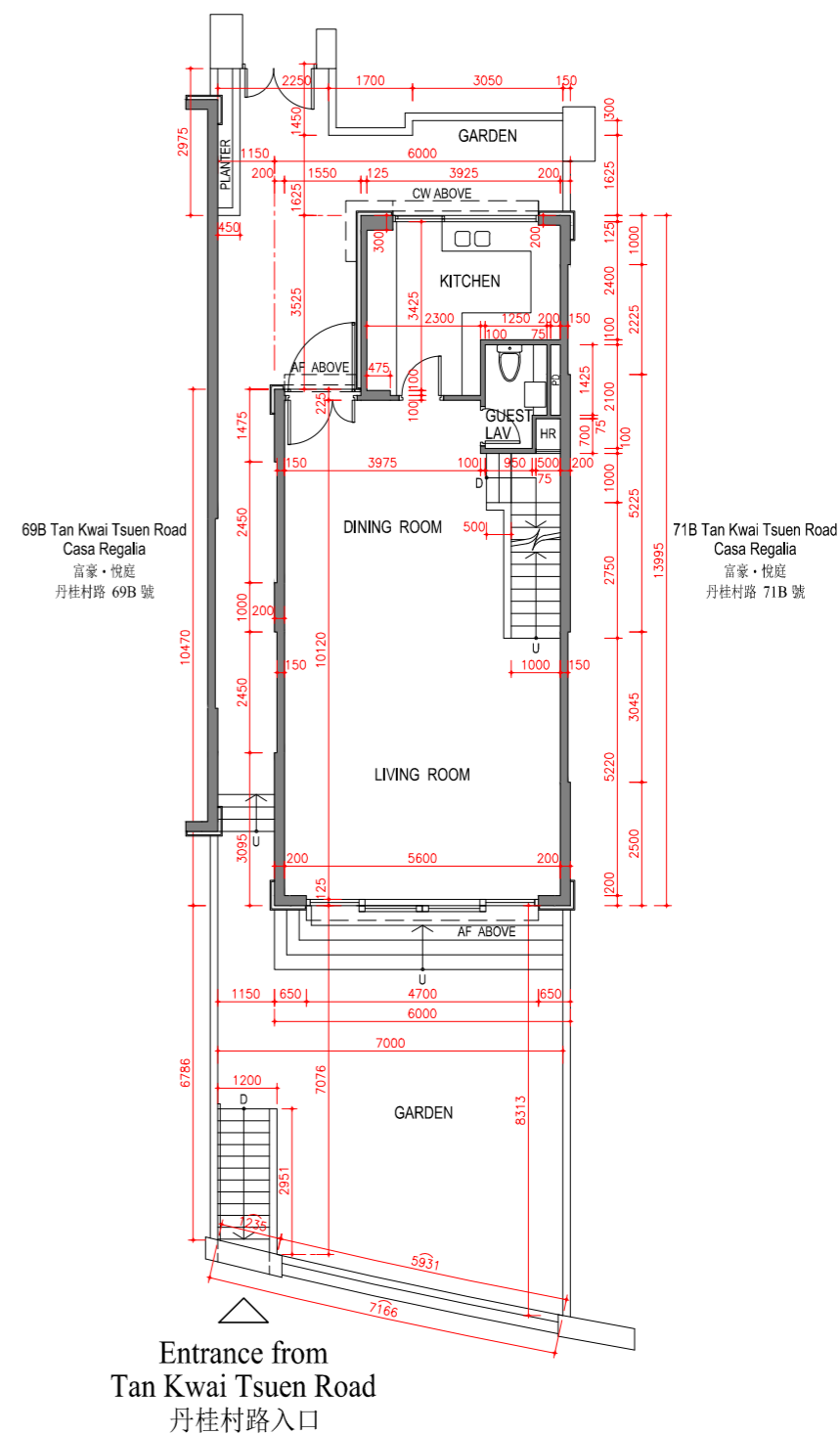

G/F Plan
地面層平面圖

Scale:
比例: 0M / 米 5M / 米

Remark:
Alterations have been made to 71A Tan Kwai Tsuen Road, Casa Regalia, please refer to the "as-is" layout plans on Pages 34A and 34B for such alterations.

備註:
富豪·悅庭丹桂村路71A號經過改動，有關改動請參閱第34A及34B頁之現狀平面圖。

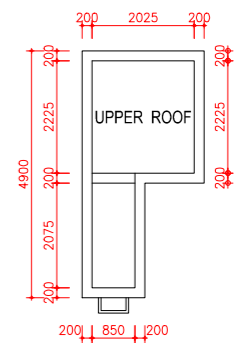
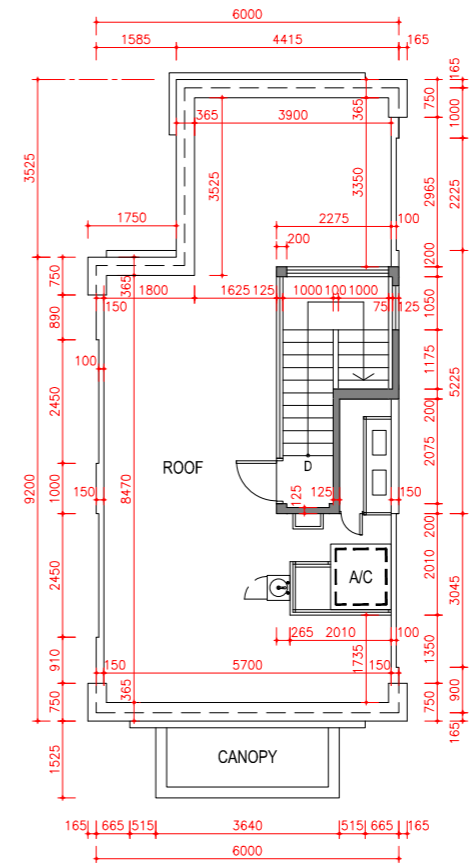
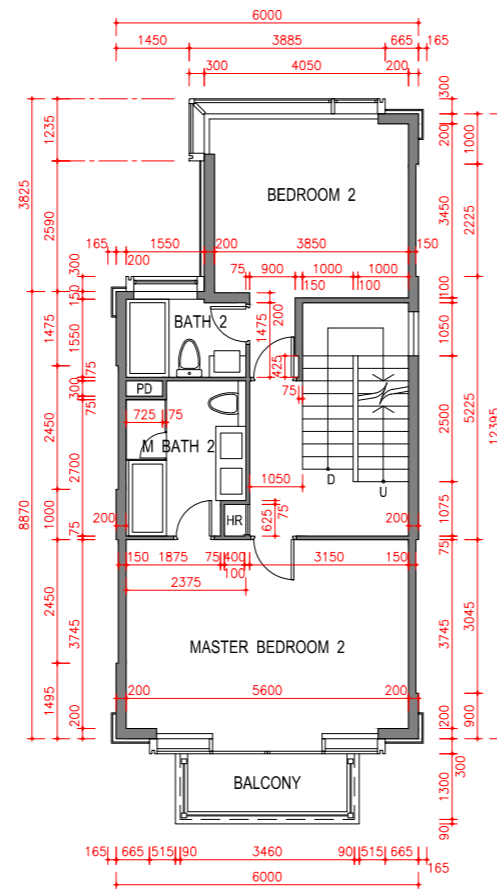
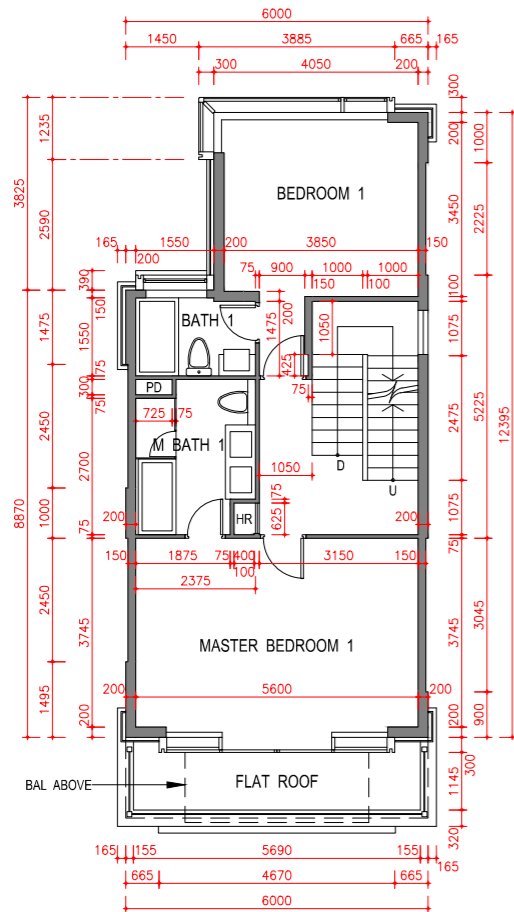

Upper Roof Plan
上層天台平面圖

71A Tan Kwai Tsuen Road, Casa Regalia 富豪·悅庭丹桂村路 71A 號

Floor 樓層	The thickness of the floor slabs (excluding plaster) of each House (mm) 每座洋房的樓板(不包括灰泥)的厚度(毫米)	The floor-to-floor height of each House (mm) 每座洋房的層與層之間的高度(毫米)
Basement 地下樓層	-	3650
G/F 地下	150, 175	4150
1/F 一樓	150, 175	3400
2/F 二樓	150, 175	3400
Roof 天台	150, 175	2825

The internal areas of the residential properties on the upper floors will generally be slightly larger than those on the lower floors because of the reducing thickness of the structural walls on the upper floors.

因住宅物業的較高樓層的結構牆的厚度遞減，較高樓層的內部面積，一般比較低樓層的內部面積稍大。

Notes:

- The dimensions of floor plans are all structural dimensions in millimeter.
- There may be architectural features and/or exposed pipes on external walls of DOMUS/Houses. For details, please refer to the latest approved building plans.
- Common pipes exposed and/or enclosed in cladding are located at/adjacent to flat roof and/or external wall of DOMUS/Houses. For details, please refer to the latest approved building plans.
- There are ceiling bulkheads and/or sunken slab of the above Flats/Houses at living/dining room, bedrooms, corridors and/or kitchen of the above Flats/Houses for the air-conditioning system and/or mechanical and electrical services.
- Please refer to page 20 of this sales brochure for legend of the terms and abbreviations shown in the floor plan above.
- Under Special Condition No. (9)(g) of the Land Grant, the total number of residential units erected or to be erected on the Lot shall not be less than 170.
- According to Clause 55 of the Third Schedule to the DMC, no Owner shall demolish or alter the partition walls separating two Residential Units (as defined in the DMC) or a common wall dividing the land upon which two Houses (as defined in the DMC) are constructed or the floor slabs or roof slabs between two Residential Units which will result in such Residential Units being internally linked to and accessible from each other, except with the prior written consent of the Director of Lands or other Government authority in place of him from time to time.

備註：

- 平面圖所列之尺寸數字為以毫米標示之建築尺寸。
- 尚築及洋房外牆設有建築裝飾及/或外露喉管。詳細資料請參考最新批准之建築圖則。
- 尚築及洋房的平台及/或外牆設有外露及/或外牆裝飾板內藏之公用喉管。詳細資料請參考最新批准的建築圖則。
- 大樓及洋房客/飯廳、睡房、走廊及/或廚房有假天花及/或有跌級樓板以內藏冷氣系統及/或機電設備。
- 以上平面圖中顯示之名詞及簡稱請參閱本售樓書第20頁。
- 批地文件特別條款第(9)(g)條規定，在該地段已建或擬建的住宅單位不得少於170個。
- 根據公契附表3第55條，除非已事先獲得地政總署署長或取代地政總署署長的其他政府機構不時作出的同意，否則任何業主不得拆卸或變更分隔兩個住宅單位(定義見公契)的間隔牆、分隔兩間洋房(定義見公契)土地的公用牆、或兩個住宅單位之間的水泥板或屋頂板以致使該等住宅單位能夠在內部連接及互通。

Remark:
This page is the additional information mentioned in the Remark on Pages 33 and 34.

備註：
本頁是第33及34頁備註附加資料。

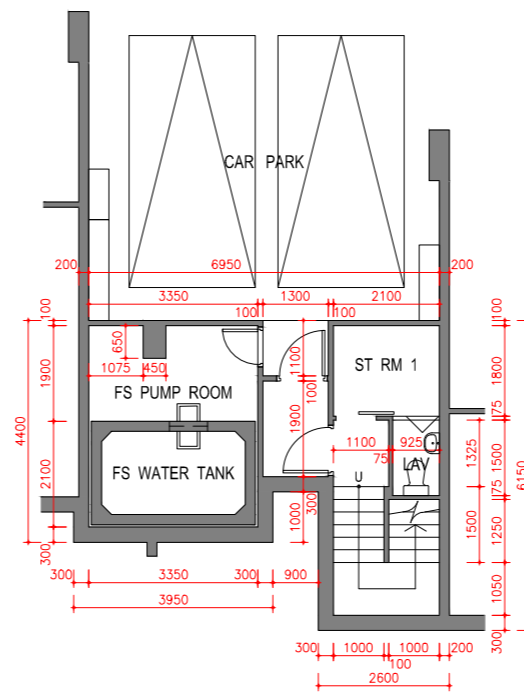

Basement Plan in "as-is" Layout
地庫現狀平面圖

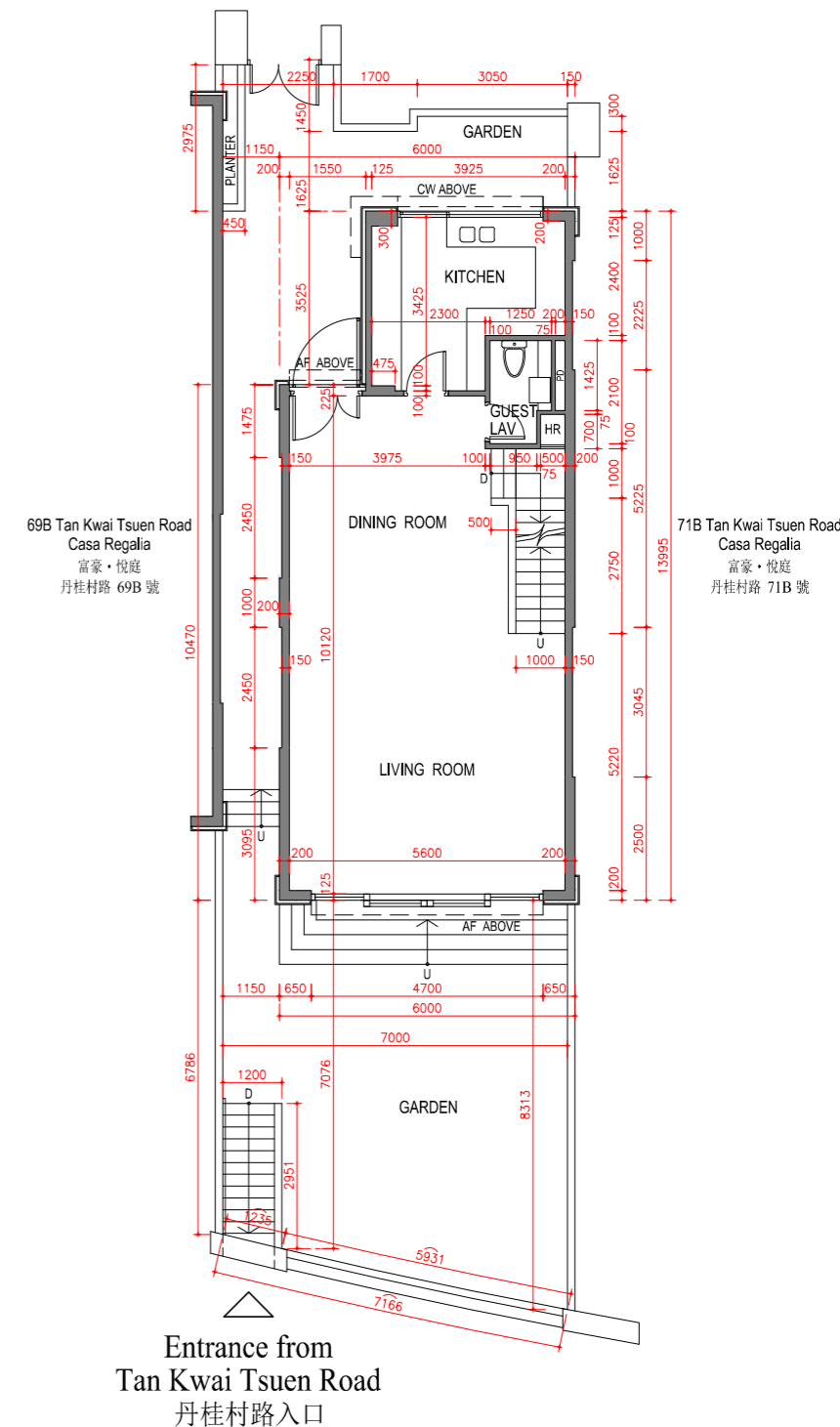

G/F Plan in "as-is" Layout
地面層現狀平面圖

71A Tan Kwai Tsuen Road, Casa Regalia has been altered by way of minor works and exempted works under the "Buildings Ordinance" after completion of the Development.
富豪·悅庭丹桂村路71A號在發展項目落成後進行小型工程及獲《建築物條例》豁免的工程。



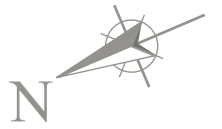

Remark:
This page is the additional information mentioned in the Remark on Pages 33 and 34.

備註:
本頁是第33及34頁備註附加資料。

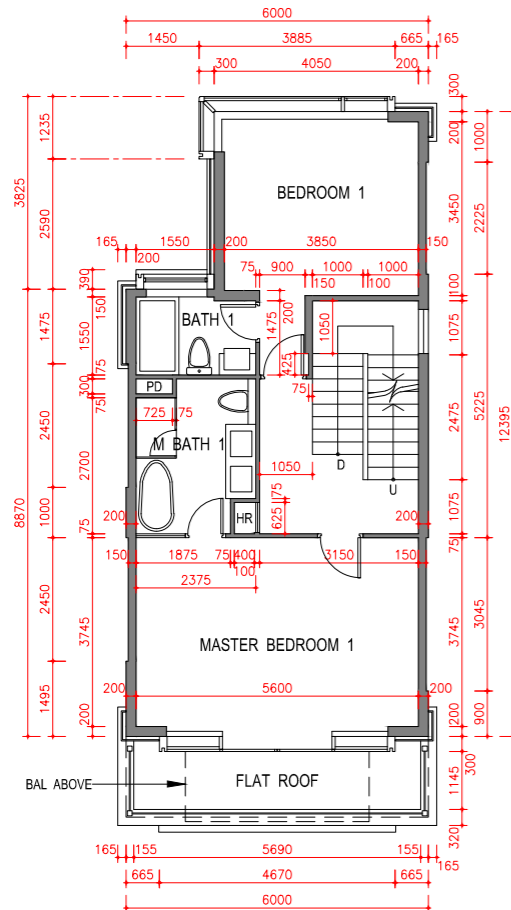

1/F Plan in "as-is" Layout
一樓現狀平面圖

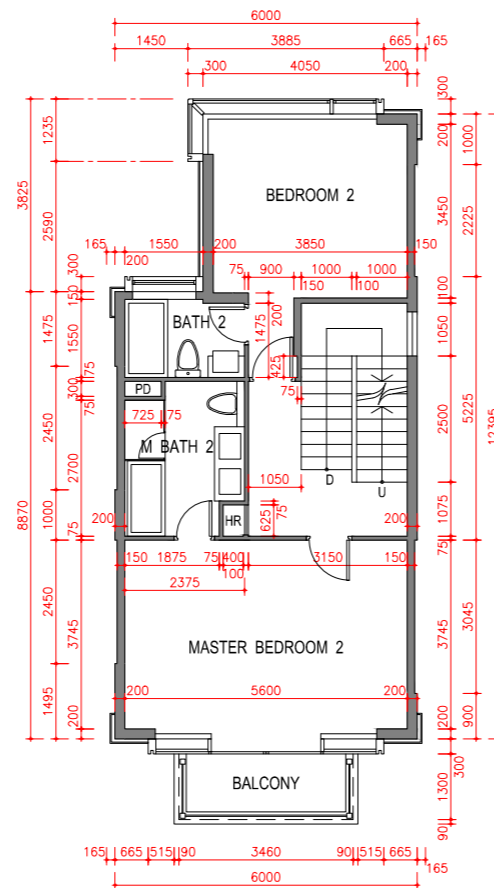

2/F Plan in "as-is" Layout
二樓現狀平面圖

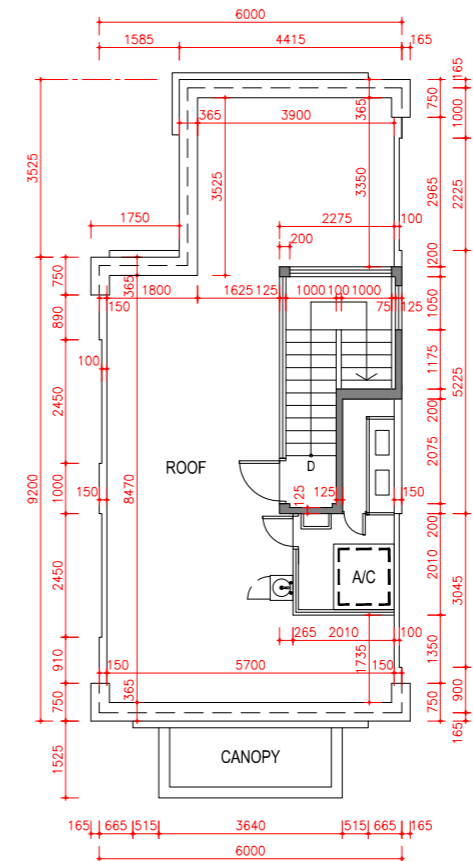

Roof Plan in "as-is" Layout
天台現狀平面圖

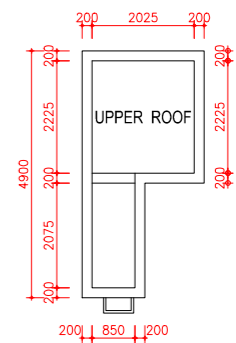

Upper Roof Plan in "as-is" Layout
上層天台現狀平面圖

71A Tan Kwai Tsuen Road, Casa Regalia has been altered by way of minor works and exempted works under the "Buildings Ordinance" after completion of the Development.
富豪·悅庭丹桂村路71A號在發展項目落成後進行小型工程及獲《建築物條例》豁免的工程。

0M / 米 5M / 米
Scale:
比例:

71B Tan Kwai Tsuen Road, Casa Regalia 富豪·悅庭丹桂村路 71B 號



Floor 樓層	The thickness of the floor slabs (excluding plaster) of each House (mm) 每座洋房的樓板(不包括灰泥)的厚度(毫米)	The floor-to-floor height of each House (mm) 每座洋房的層與層之間的高度(毫米)
Basement 地下樓層	-	3650
G/F 地下	150, 175	4150
1/F 一樓	150, 175	3400
2/F 二樓	150, 175	3400
Roof 天台	150, 175	2825

The internal areas of the residential properties on the upper floors will generally be slightly larger than those on the lower floors because of the reducing thickness of the structural walls on the upper floors.

因住宅物業的較高樓層的結構牆的厚度遞減，較高樓層的內部面積，一般比較低樓層的內部面積稍大。

Notes:

- The dimensions of floor plans are all structural dimensions in millimeter.
- There may be architectural features and/or exposed pipes on external walls of DOMUS/Houses. For details, please refer to the latest approved building plans.
- Common pipes exposed and/or enclosed in cladding are located at/adjacent to flat roof and/or external wall of DOMUS/Houses. For details, please refer to the latest approved building plans.
- There are ceiling bulkheads and/or sunken slab of the above Flats/Houses at living/dining room, bedrooms, corridors and/or kitchen of the above Flats/Houses for the air-conditioning system and/or mechanical and electrical services.
- Please refer to page 20 of this sales brochure for legend of the terms and abbreviations shown in the floor plan above.
- Under Special Condition No. (9)(g) of the Land Grant, the total number of residential units erected or to be erected on the Lot shall not be less than 170.
- According to Clause 55 of the Third Schedule to the DMC, no Owner shall demolish or alter the partition walls separating two Residential Units (as defined in the DMC) or a common wall dividing the land upon which two Houses (as defined in the DMC) are constructed or the floor slabs or roof slabs between two Residential Units which will result in such Residential Units being internally linked to and accessible from each other, except with the prior written consent of the Director of Lands or other Government authority in place of him from time to time.

備註：

- 平面圖所列之尺寸數字為以毫米標示之建築尺寸。
- 尚築及洋房外牆設有建築裝飾及/或外露喉管。詳細資料請參考最新批准之建築圖則。
- 尚築及洋房的平台及/或外牆設有外露及/或外牆裝飾板內藏之公用喉管。詳細資料請參考最新批准的建築圖則。
- 大樓及洋房客/飯廳、睡房、走廊及/或廚房有假天花及/或有跌級樓板以內藏冷氣系統及/或機電設備。
- 以上平面圖中顯示之名詞及簡稱請參閱本售樓書第20頁。
- 批地文件特別條款第(9)(g)條規定，在該地段已建或擬建的住宅單位不得少於170個。
- 根據公契附表3第55條，除非已事先獲得地政總署署長或取代地政總署署長的其他政府機構不時作出的同意，否則任何業主不得拆卸或變更分隔兩個住宅單位(定義見公契)的間隔牆、分隔兩間洋房(定義見公契)土地的公用牆、或兩個住宅單位之間的水泥板或屋頂板以致使該等住宅單位能夠在內部連接及互通。

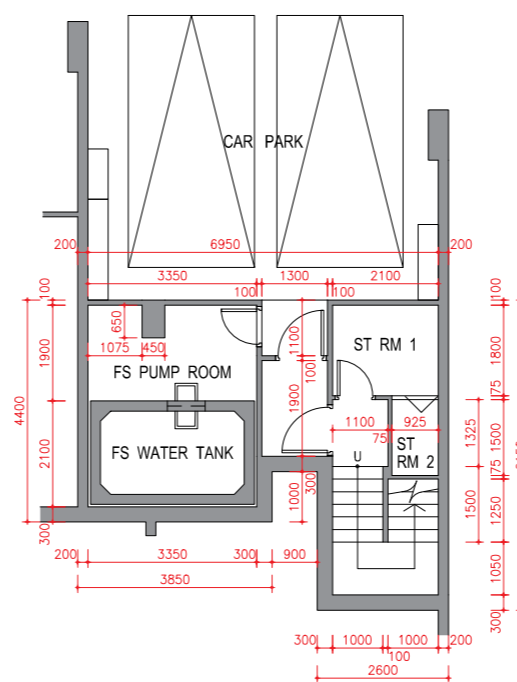

Basement Plan
地庫平面圖

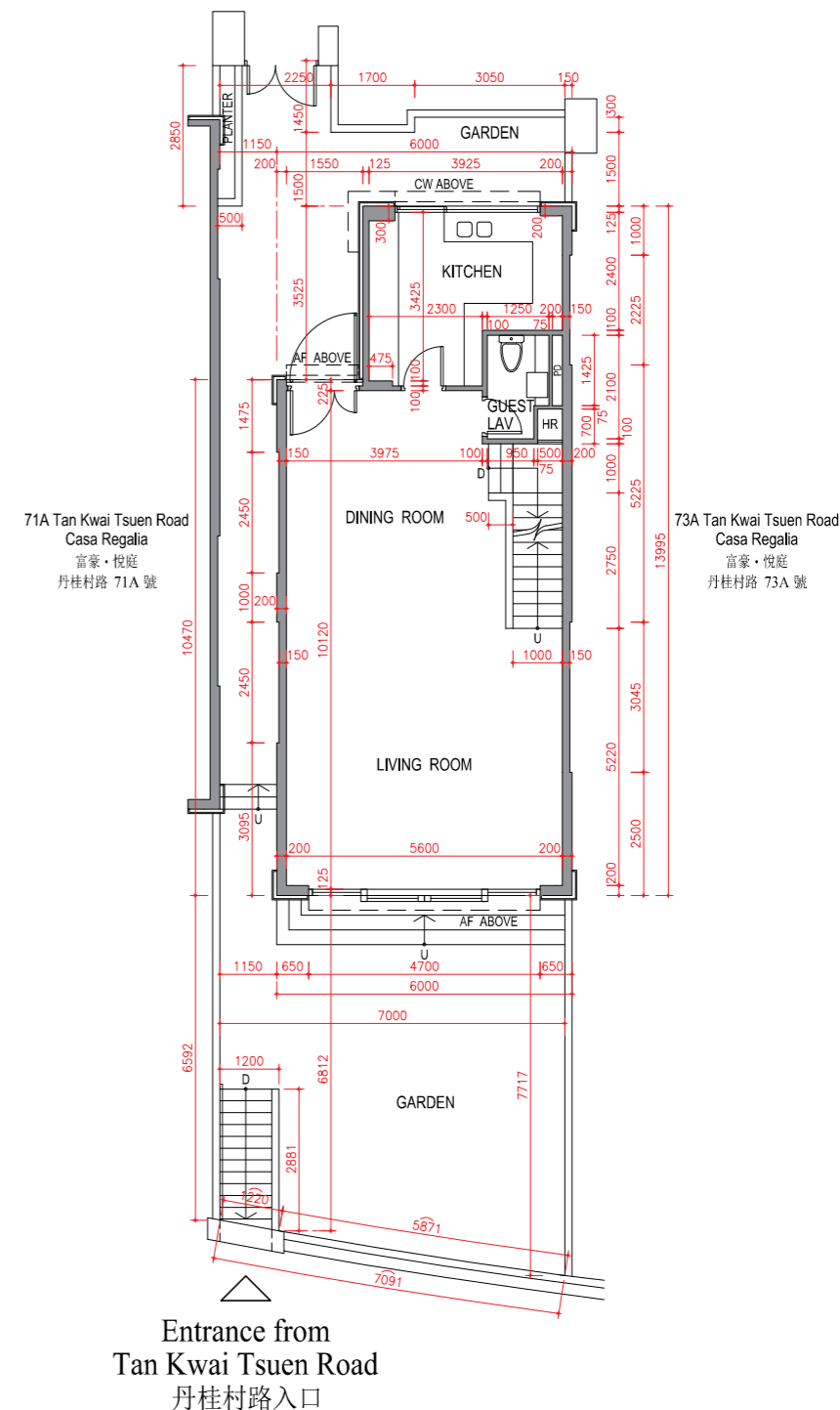

G/F Plan
地面層平面圖

Scale: 0M / 米 5M / 米
比例:

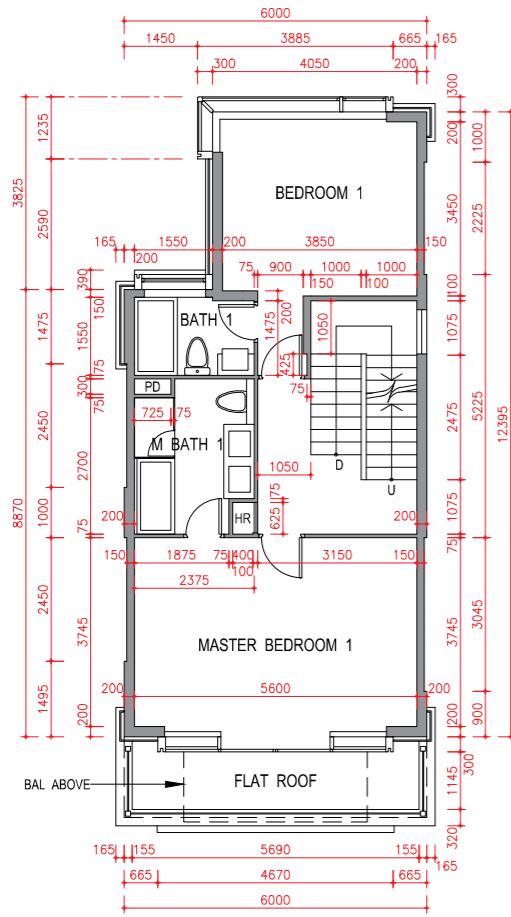
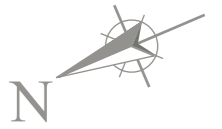

1/F Plan
一樓平面圖

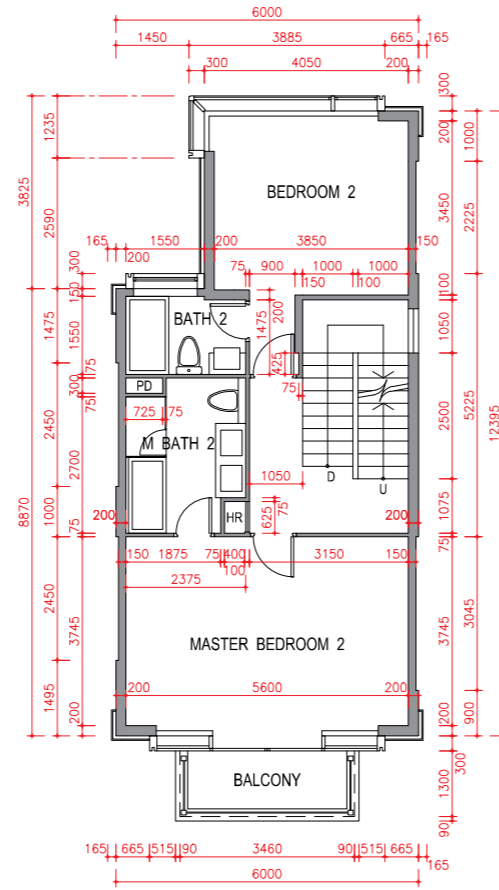

2/F Plan
二樓平面圖

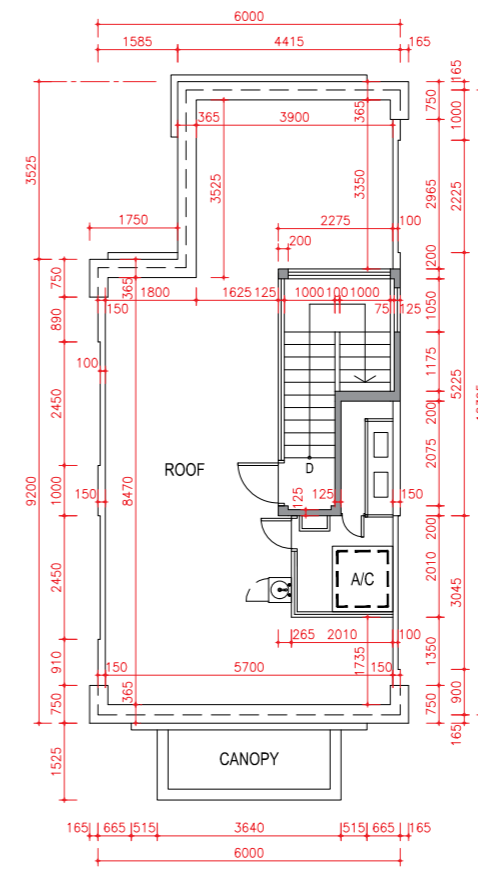

Roof Plan
天台平面圖

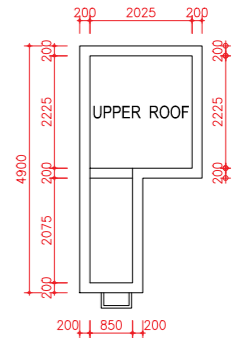

Upper Roof Plan
上層天台平面圖

73A Tan Kwai Tsuen Road, Casa Regalia 富豪·悅庭丹桂村路 73A 號



Floor 樓層	The thickness of the floor slabs (excluding plaster) of each House (mm) 每座洋房的樓板(不包括灰泥)的厚度(毫米)	The floor-to-floor height of each House (mm) 每座洋房的層與層之間的高度(毫米)
Basement 地下樓層	-	3650
G/F 地下	150, 175	4150
1/F 一樓	150, 175	3400
2/F 二樓	150, 175	3400
Roof 天台	150, 175	2825

The internal areas of the residential properties on the upper floors will generally be slightly larger than those on the lower floors because of the reducing thickness of the structural walls on the upper floors.

因住宅物業的較高樓層的結構牆的厚度遞減，較高樓層的內部面積，一般比較低樓層的內部面積稍大。

Notes:

- The dimensions of floor plans are all structural dimensions in millimeter.
- There may be architectural features and/or exposed pipes on external walls of DOMUS/Houses. For details, please refer to the latest approved building plans.
- Common pipes exposed and/or enclosed in cladding are located at/adjacent to flat roof and/or external wall of DOMUS/Houses. For details, please refer to the latest approved building plans.
- There are ceiling bulkheads and/or sunken slab of the above Flats/Houses at living/dining room, bedrooms, corridors and/or kitchen of the above Flats/Houses for the air-conditioning system and/or mechanical and electrical services.
- Please refer to page 20 of this sales brochure for legend of the terms and abbreviations shown in the floor plan above.
- Under Special Condition No. (9)(g) of the Land Grant, the total number of residential units erected or to be erected on the Lot shall not be less than 170.
- According to Clause 55 of the Third Schedule to the DMC, no Owner shall demolish or alter the partition walls separating two Residential Units (as defined in the DMC) or a common wall dividing the land upon which two Houses (as defined in the DMC) are constructed or the floor slabs or roof slabs between two Residential Units which will result in such Residential Units being internally linked to and accessible from each other, except with the prior written consent of the Director of Lands or other Government authority in place of him from time to time.

備註：

- 平面圖所列之尺寸數字為以毫米標示之建築尺寸。
- 尚築及洋房外牆設有建築裝飾及/或外露喉管。詳細資料請參考最新批准之建築圖則。
- 尚築及洋房的平台及/或外牆設有外露及/或外牆裝飾板內藏之公用喉管。詳細資料請參考最新批准的建築圖則。
- 大樓及洋房客/飯廳、睡房、走廊及/或廚房有假天花及/或有跌級樓板以內藏冷氣系統及/或機電設備。
- 以上平面圖中顯示之名詞及簡稱請參閱本售樓書第20頁。
- 批地文件特別條款第(9)(g)條規定，在該地段已建或擬建的住宅單位不得少於170個。
- 根據公契附表3第55條，除非已事先獲得地政總署署長或取代地政總署署長的其他政府機構不時作出的同意，否則任何業主不得拆卸或變更分隔兩個住宅單位(定義見公契)的間隔牆、分隔兩間洋房(定義見公契)土地的公用牆、或兩個住宅單位之間的水泥板或屋頂板以致使該等住宅單位能夠在內部連接及互通。

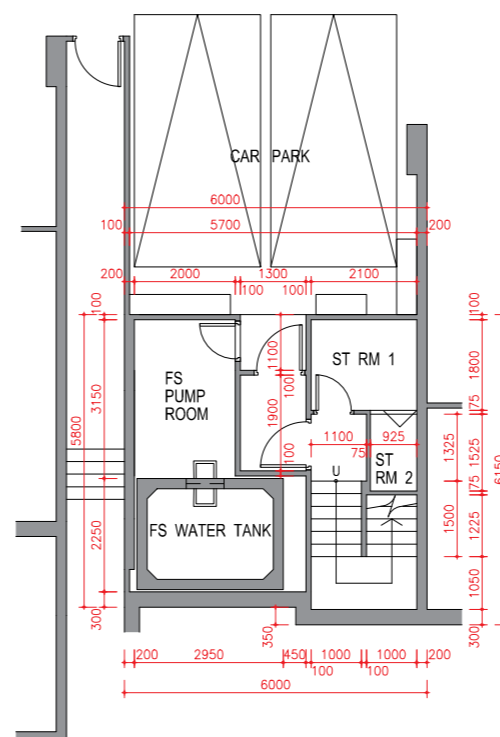

Basement Plan
地庫平面圖

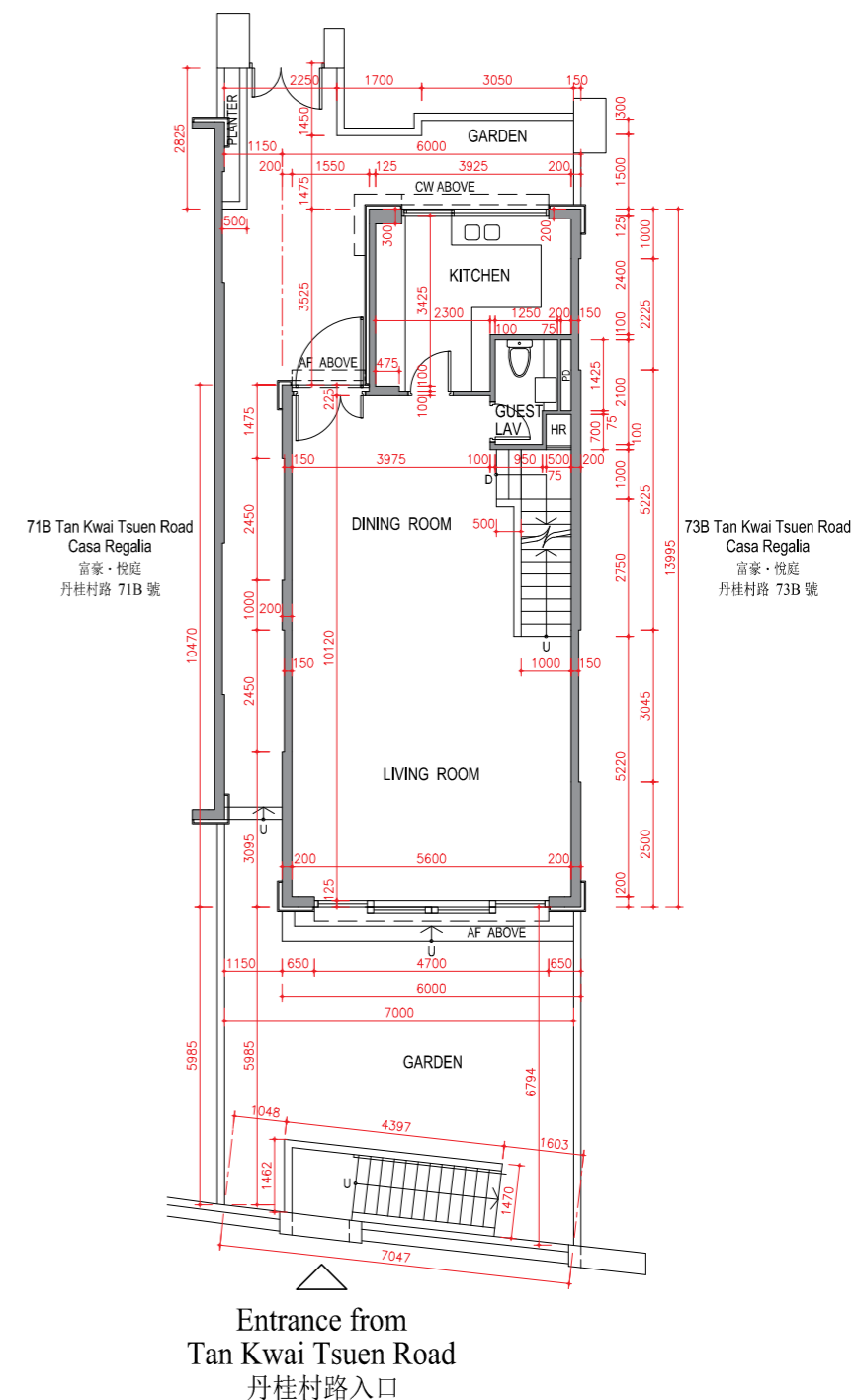

Entrance from
Tan Kwai Tsuen Road
丹桂村路入口

G/F Plan
地面層平面圖

0M / 米
Scale:
比例: 5M / 米

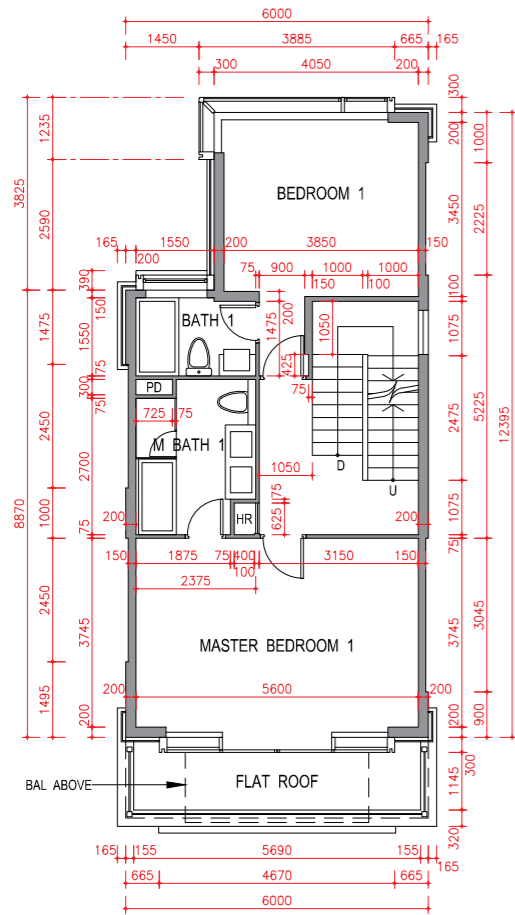
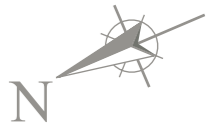

1/F Plan
一樓平面圖

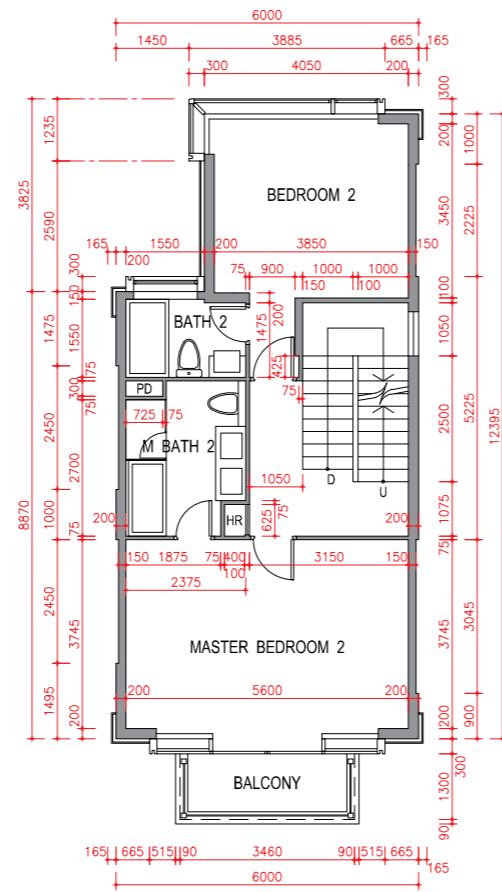

2/F Plan
二樓平面圖

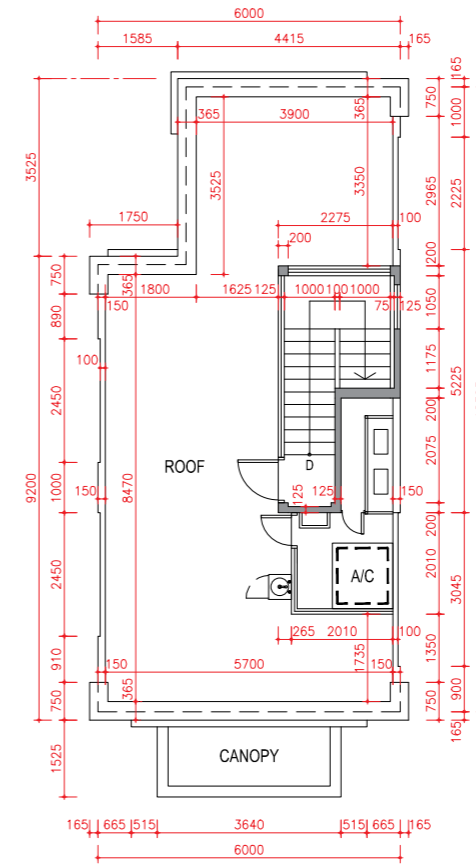

Roof Plan
天台平面圖

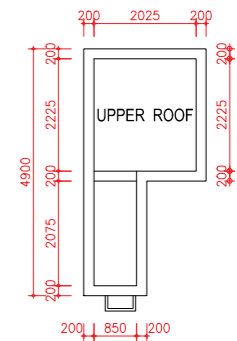

Upper Roof Plan
上層天台平面圖

73B Tan Kwai Tsuen Road, Casa Regalia 富豪·悦庭丹桂村路 73B 號



Floor 樓層	The thickness of the floor slabs (excluding plaster) of each House (mm) 每座洋房的樓板(不包括灰泥)的厚度(毫米)	The floor-to-floor height of each House (mm) 每座洋房的層與層之間的高度(毫米)
Basement 地下樓層	-	3650
G/F 地下	150, 175	4150
1/F 一樓	150, 175	3400
2/F 二樓	150, 175	3400
Roof 天台	150, 175	2825

The internal areas of the residential properties on the upper floors will generally be slightly larger than those on the lower floors because of the reducing thickness of the structural walls on the upper floors.

因住宅物業的較高樓層的結構牆的厚度遞減，較高樓層的內部面積，一般比較低樓層的內部面積稍大。

Notes:

- The dimensions of floor plans are all structural dimensions in millimeter.
- There may be architectural features and/or exposed pipes on external walls of DOMUS/Houses. For details, please refer to the latest approved building plans.
- Common pipes exposed and/or enclosed in cladding are located at/adjacent to flat roof and/or external wall of DOMUS/Houses. For details, please refer to the latest approved building plans.
- There are ceiling bulkheads and/or sunken slab of the above Flats/Houses at living/dining room, bedrooms, corridors and/or kitchen of the above Flats/Houses for the air-conditioning system and/or mechanical and electrical services.
- Please refer to page 20 of this sales brochure for legend of the terms and abbreviations shown in the floor plan above.
- Under Special Condition No. (9)(g) of the Land Grant, the total number of residential units erected or to be erected on the Lot shall not be less than 170.
- According to Clause 55 of the Third Schedule to the DMC, no Owner shall demolish or alter the partition walls separating two Residential Units (as defined in the DMC) or a common wall dividing the land upon which two Houses (as defined in the DMC) are constructed or the floor slabs or roof slabs between two Residential Units which will result in such Residential Units being internally linked to and accessible from each other, except with the prior written consent of the Director of Lands or other Government authority in place of him from time to time.

備註：

- 平面圖所列之尺寸數字為以毫米標示之建築尺寸。
- 尚築及洋房外牆設有建築裝飾及/或外露喉管。詳細資料請參考最新批准之建築圖則。
- 尚築及洋房的平台及/或外牆設有外露及/或外牆裝飾板內藏之公用喉管。詳細資料請參考最新批准的建築圖則。
- 大樓及洋房客/飯廳、睡房、走廊及/或廚房有假天花及/或有跌級樓板以內藏冷氣系統及/或機電設備。
- 以上平面圖中顯示之名詞及簡稱請參閱本售樓書第20頁。
- 批地文件特別條款第(9)(g)條規定，在該地段已建或擬建的住宅單位不得少於170個。
- 根據公契附表3第55條，除非已事先獲得地政總署署長或取代地政總署署長的其他政府機構不時作出的同意，否則任何業主不得拆卸或變更分隔兩個住宅單位(定義見公契)的間隔牆、分隔兩間洋房(定義見公契)土地的公用牆、或兩個住宅單位之間的水泥板或屋頂板以致使該等住宅單位能夠在內部連接及互通。

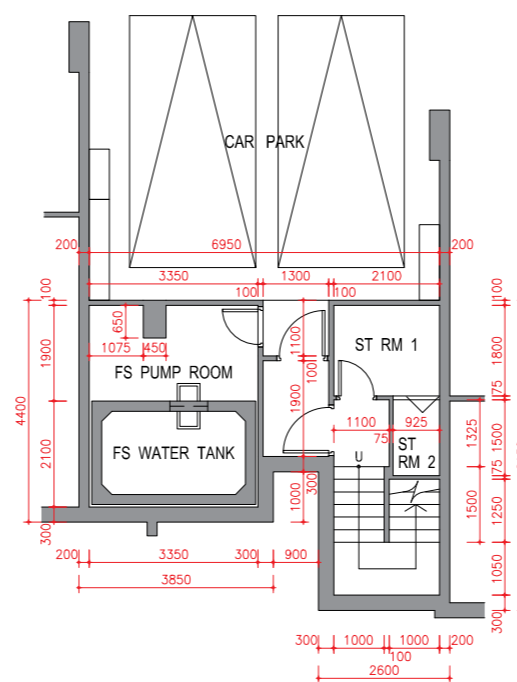

Basement Plan
地庫平面圖

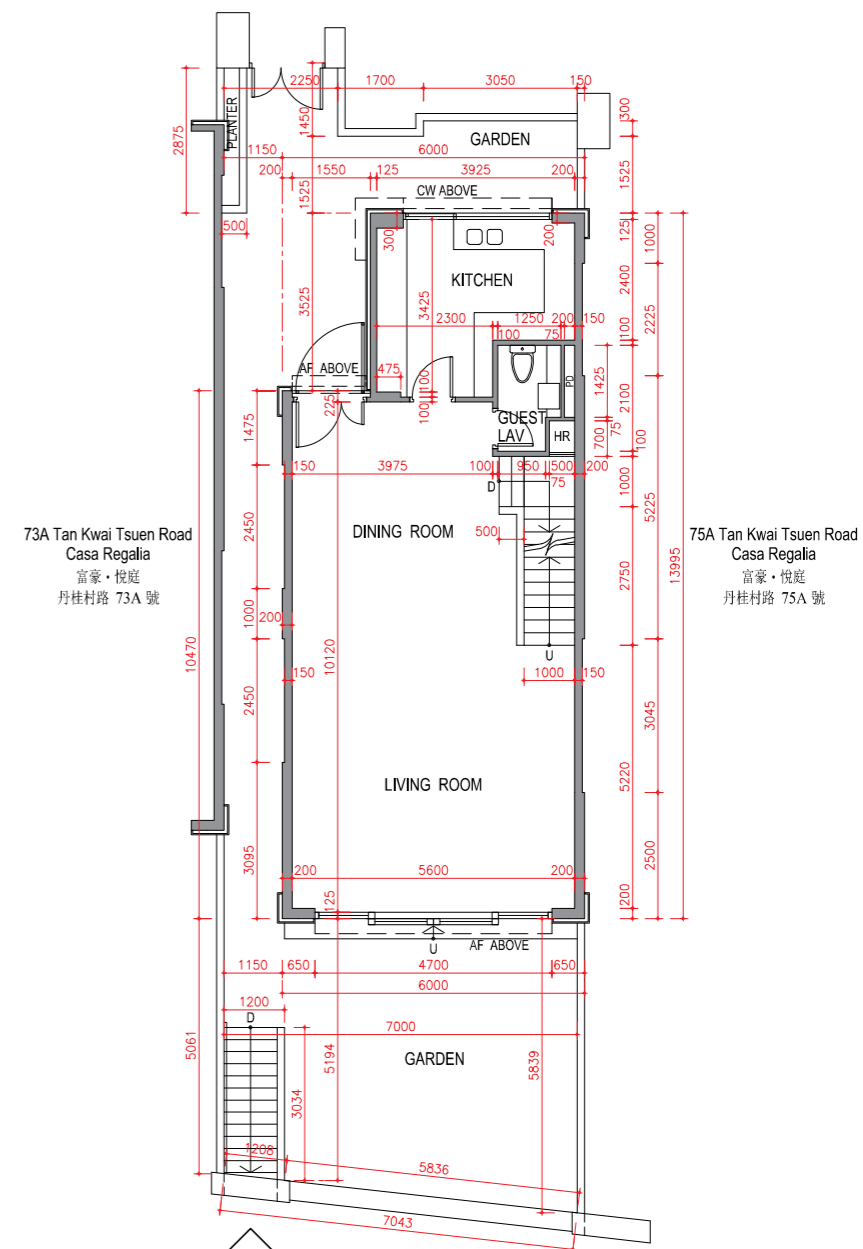

Entrance from
Tan Kwai Tsuen Road
丹桂村路入口

G/F Plan
地面層平面圖

Scale:
比例: 0M / 米 5M / 米

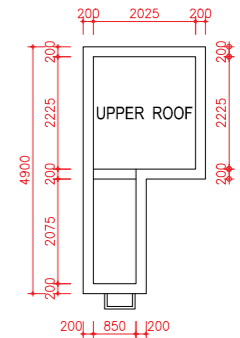
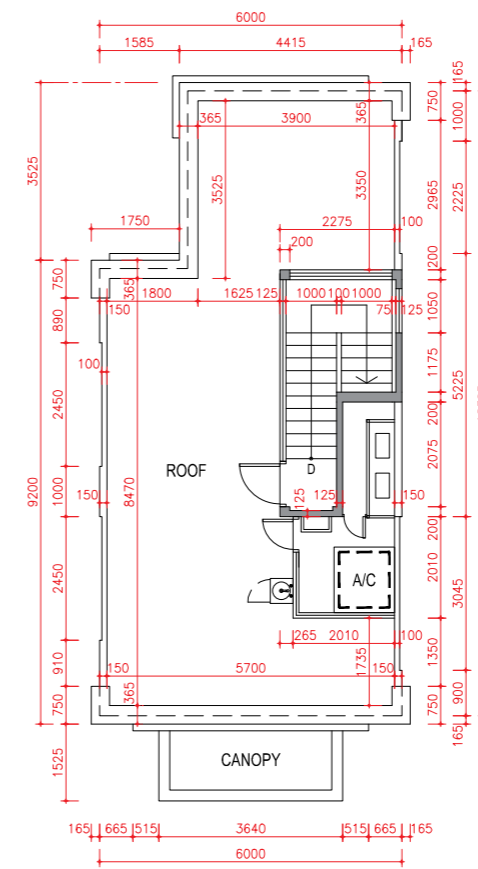
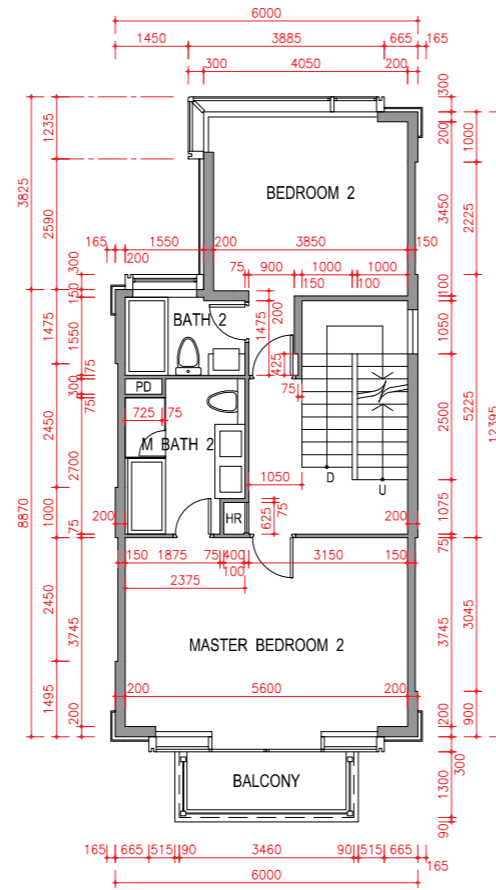
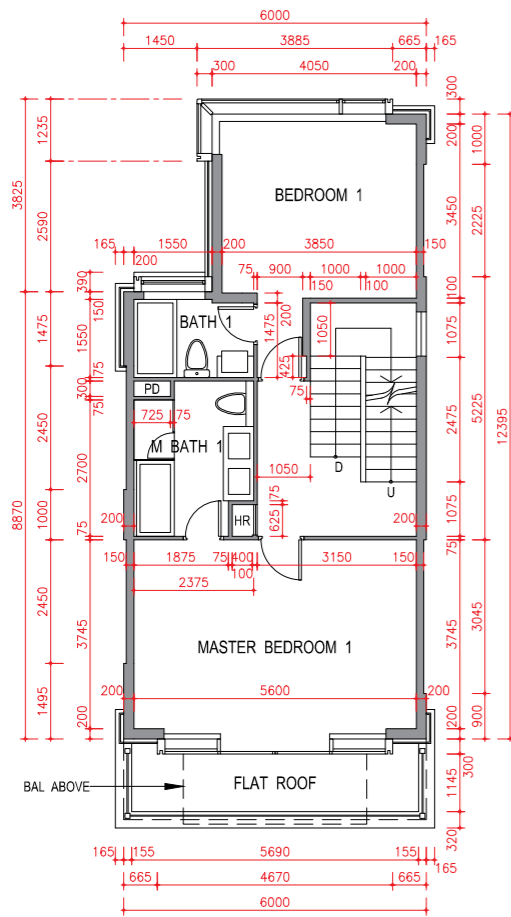
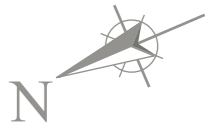

Upper Roof Plan
上層天台平面圖

75A Tan Kwai Tsuen Road, Casa Regalia 富豪·悦庭丹桂村路 75A 號

Floor 樓層	The thickness of the floor slabs (excluding plaster) of each House (mm) 每座洋房的樓板(不包括灰泥)的厚度(毫米)	The floor-to-floor height of each House (mm) 每座洋房的層與層之間的高度(毫米)
Basement 地下樓層	-	3650
G/F 地下	150, 175	4150
1/F 一樓	150, 175	3400
2/F 二樓	150	3400
Roof 天台	150	2825

The internal areas of the residential properties on the upper floors will generally be slightly larger than those on the lower floors because of the reducing thickness of the structural walls on the upper floors.

因住宅物業的較高樓層的結構牆的厚度遞減，較高樓層的內部面積，一般比較低樓層的內部面積稍大。

Notes:

- The dimensions of floor plans are all structural dimensions in millimeter.
- There may be architectural features and/or exposed pipes on external walls of DOMUS/Houses. For details, please refer to the latest approved building plans.
- Common pipes exposed and/or enclosed in cladding are located at/adjacent to flat roof and/or external wall of DOMUS/Houses. For details, please refer to the latest approved building plans.
- There are ceiling bulkheads and/or sunken slab of the above Flats/Houses at living/dining room, bedrooms, corridors and/or kitchen of the above Flats/Houses for the air-conditioning system and/or mechanical and electrical services.
- Please refer to page 20 of this sales brochure for legend of the terms and abbreviations shown in the floor plan above.
- Under Special Condition No. (9)(g) of the Land Grant, the total number of residential units erected or to be erected on the Lot shall not be less than 170.
- According to Clause 55 of the Third Schedule to the DMC, no Owner shall demolish or alter the partition walls separating two Residential Units (as defined in the DMC) or a common wall dividing the land upon which two Houses (as defined in the DMC) are constructed or the floor slabs or roof slabs between two Residential Units which will result in such Residential Units being internally linked to and accessible from each other, except with the prior written consent of the Director of Lands or other Government authority in place of him from time to time.

備註：

- 平面圖所列之尺寸數字為以毫米標示之建築尺寸。
- 尚築及洋房外牆設有建築裝飾及/或外露喉管。詳細資料請參考最新批准之建築圖則。
- 尚築及洋房的平台及/或外牆設有外露及/或外牆裝飾板內藏之公用喉管。詳細資料請參考最新批准的建築圖則。
- 大樓及洋房客/飯廳、睡房、走廊及/或廚房有假天花及/或有跌級樓板以內藏冷氣系統及/或機電設備。
- 以上平面圖中顯示之名詞及簡稱請參閱本售樓書第20頁。
- 批地文件特別條款第(9)(g)條規定，在該地段已建或擬建的住宅單位不得少於170個。
- 根據公契附表3第55條，除非已事先獲得地政總署署長或取代地政總署署長的其他政府機構不時作出的同意，否則任何業主不得拆卸或變更分隔兩個住宅單位(定義見公契)的間隔牆、分隔兩間洋房(定義見公契)土地的公用牆、或兩個住宅單位之間的水泥板或屋頂板以致使該等住宅單位能夠在內部連接及互通。

Remark:

Alterations have been made to 75A Tan Kwai Tsuen Road, Casa Regalia, please refer to the "as-is" layout plans on Pages 42A and 42B for such alterations.

備註：

富豪·悦庭丹桂村路75A號經過改動，有關改動請參閱第42A及42B頁之現狀平面圖。

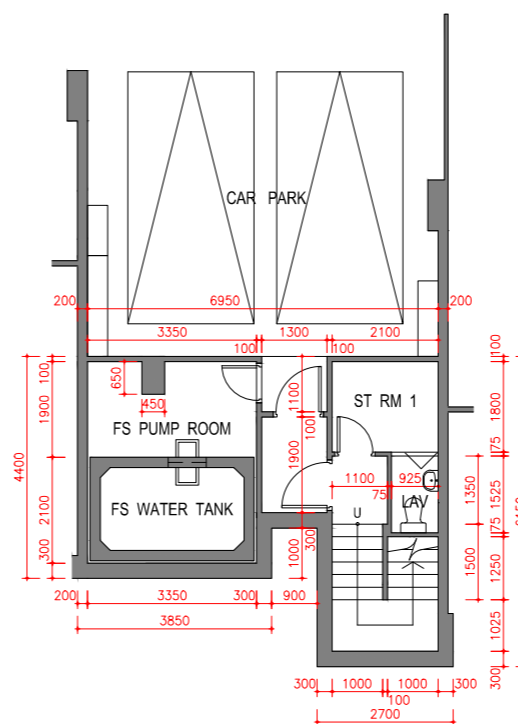

Basement Plan
地庫平面圖

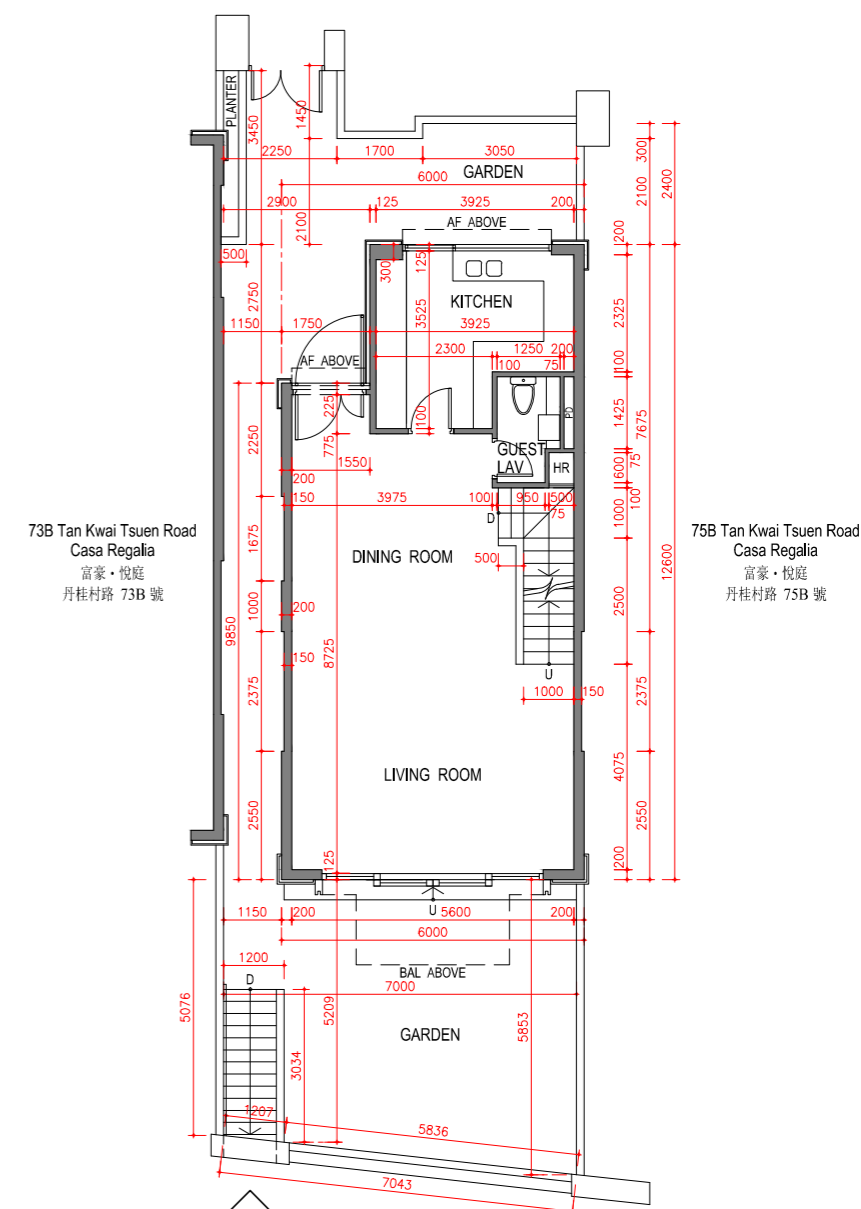

Entrance from
Tan Kwai Tsuen Road
丹桂村路入口

G/F Plan
地面層平面圖

0M / 米 5M / 米
Scale:
比例:



Remark:
Alterations have been made to 75A Tan Kwai Tsuen Road, Casa Regalia, please refer to the
“as-is” layout plans on Pages 42A and 42B for such alterations.

備註：
富豪·悅庭丹桂村路75A號經過改動，有關改動請參閱第42A及42B頁之現狀平面圖。

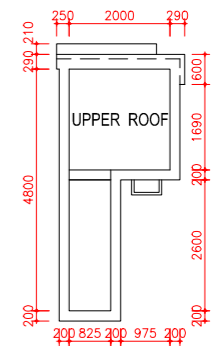
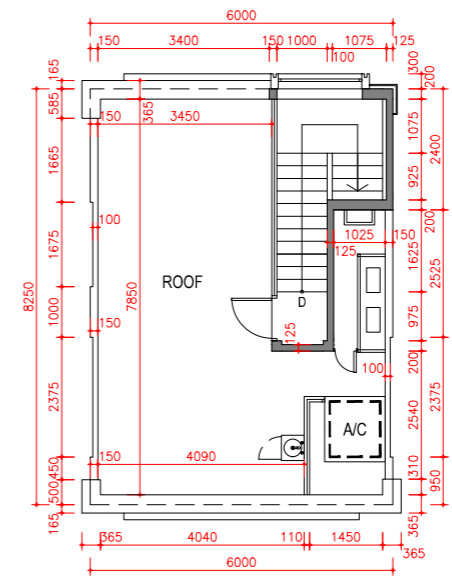
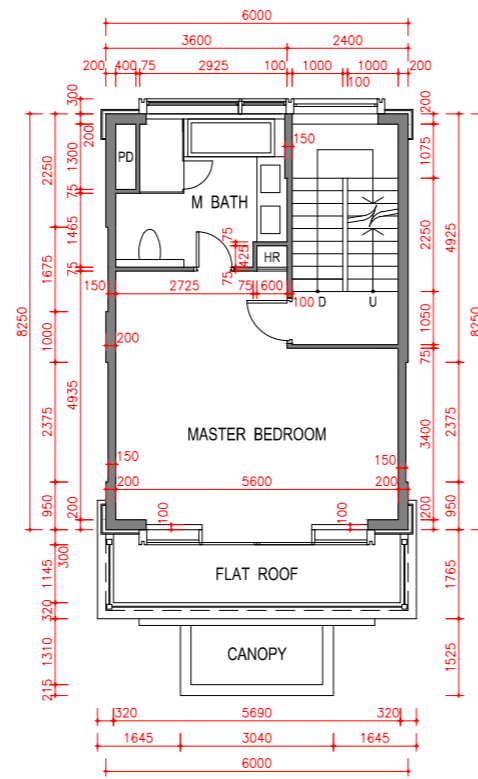
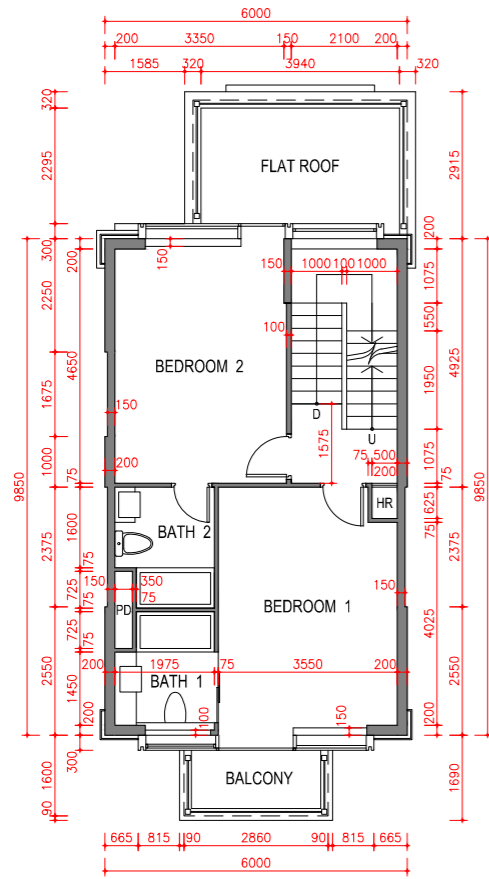

Upper Roof Plan
上層天台平面圖

75A Tan Kwai Tsuen Road, Casa Regalia 富豪·悦庭丹桂村路 75A 號

Floor 樓層	The thickness of the floor slabs (excluding plaster) of each House (mm) 每座洋房的樓板(不包括灰泥)的厚度(毫米)	The floor-to-floor height of each House (mm) 每座洋房的層與層之間的高度(毫米)
Basement 地下樓層	-	3650
G/F 地下	150, 175	4150
1/F 一樓	150, 175	3400
2/F 二樓	150	3400
Roof 天台	150	2825

The internal areas of the residential properties on the upper floors will generally be slightly larger than those on the lower floors because of the reducing thickness of the structural walls on the upper floors.

因住宅物業的較高樓層的結構牆的厚度遞減，較高樓層的內部面積，一般比較低樓層的內部面積稍大。

Notes:

- The dimensions of floor plans are all structural dimensions in millimeter.
- There may be architectural features and/or exposed pipes on external walls of DOMUS/Houses. For details, please refer to the latest approved building plans.
- Common pipes exposed and/or enclosed in cladding are located at/adjacent to flat roof and/or external wall of DOMUS/Houses. For details, please refer to the latest approved building plans.
- There are ceiling bulkheads and/or sunken slab of the above Flats/Houses at living/dining room, bedrooms, corridors and/or kitchen of the above Flats/Houses for the air-conditioning system and/or mechanical and electrical services.
- Please refer to page 20 of this sales brochure for legend of the terms and abbreviations shown in the floor plan above.
- Under Special Condition No. (9)(g) of the Land Grant, the total number of residential units erected or to be erected on the Lot shall not be less than 170.
- According to Clause 55 of the Third Schedule to the DMC, no Owner shall demolish or alter the partition walls separating two Residential Units (as defined in the DMC) or a common wall dividing the land upon which two Houses (as defined in the DMC) are constructed or the floor slabs or roof slabs between two Residential Units which will result in such Residential Units being internally linked to and accessible from each other, except with the prior written consent of the Director of Lands or other Government authority in place of him from time to time.

備註：

- 平面圖所列之尺寸數字為以毫米標示之建築尺寸。
- 尚築及洋房外牆設有建築裝飾及/或外露喉管。詳細資料請參考最新批准之建築圖則。
- 尚築及洋房的平台及/或外牆設有外露及/或外牆裝飾板內藏之公用喉管。詳細資料請參考最新批准的建築圖則。
- 大樓及洋房客/飯廳、睡房、走廊及/或廚房有假天花及/或有跌級樓板以內藏冷氣系統及/或機電設備。
- 以上平面圖中顯示之名詞及簡稱請參閱本售樓書第20頁。
- 批地文件特別條款第(9)(g)條規定，在該地段已建或擬建的住宅單位不得少於170個。
- 根據公契附表3第55條，除非已事先獲得地政總署署長或取代地政總署署長的其他政府機構不時作出的同意，否則任何業主不得拆卸或變更分隔兩個住宅單位(定義見公契)的間隔牆、分隔兩間洋房(定義見公契)土地的公用牆、或兩個住宅單位之間的水泥板或屋頂板以致使該等住宅單位能夠在內部連接及互通。

Remark:
This page is the additional information mentioned in the Remark on Pages 41 and 42.

備註：
本頁是第41及42頁備註附加資料。

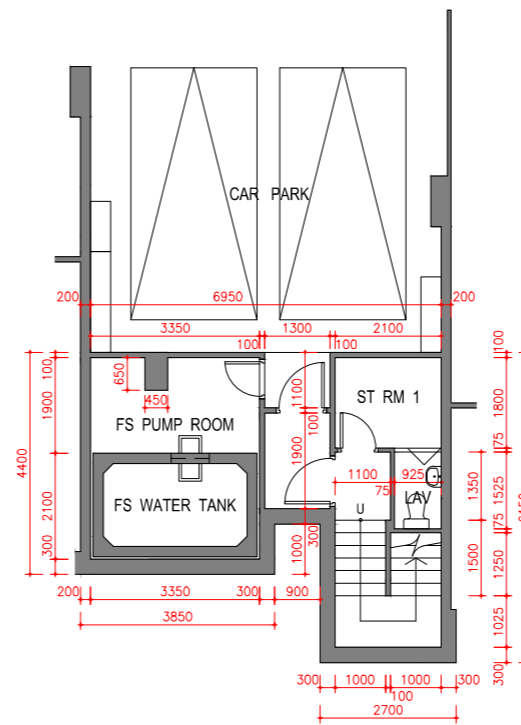

Basement Plan in "as-is" Layout
地庫現狀平面圖

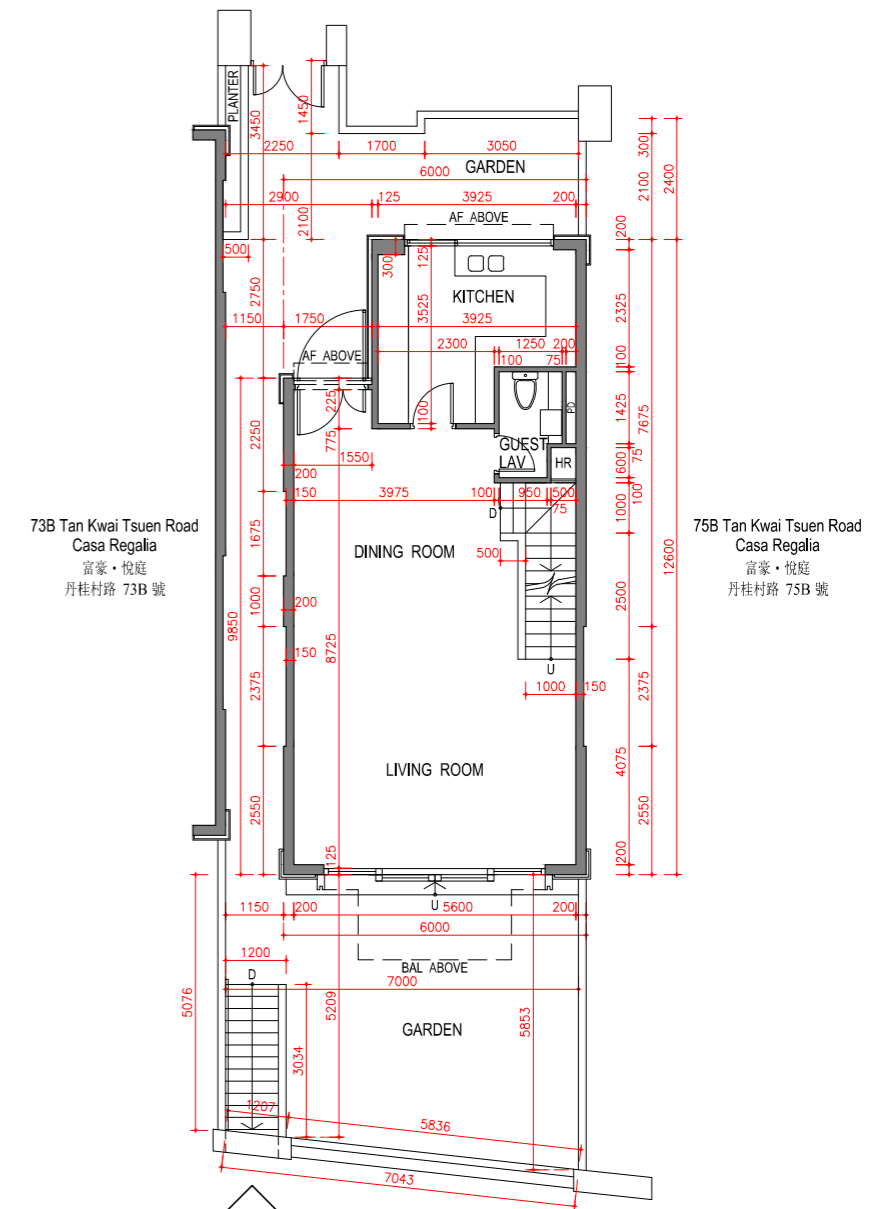

Entrance from
Tan Kwai Tsuen Road
丹桂村路入口

G/F Plan in "as-is" Layout
地面層現狀平面圖

75A Tan Kwai Tsuen Road, Casa Regalia has been altered by way of minor works and exempted works under the "Buildings Ordinance" after completion of the Development.
富豪·悦庭丹桂村路75A號在發展項目落成後進行小型工程及獲《建築物條例》豁免的工程。



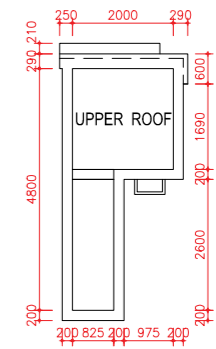
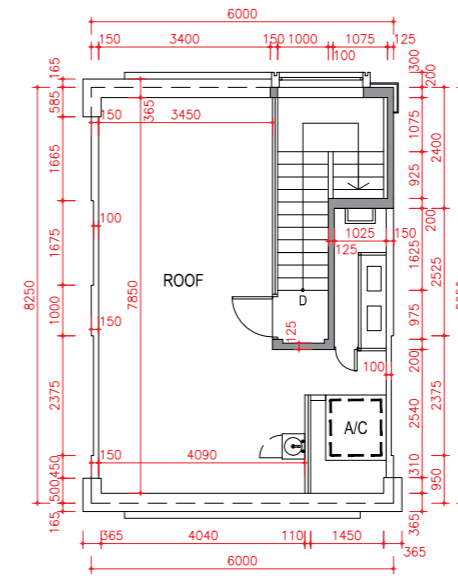
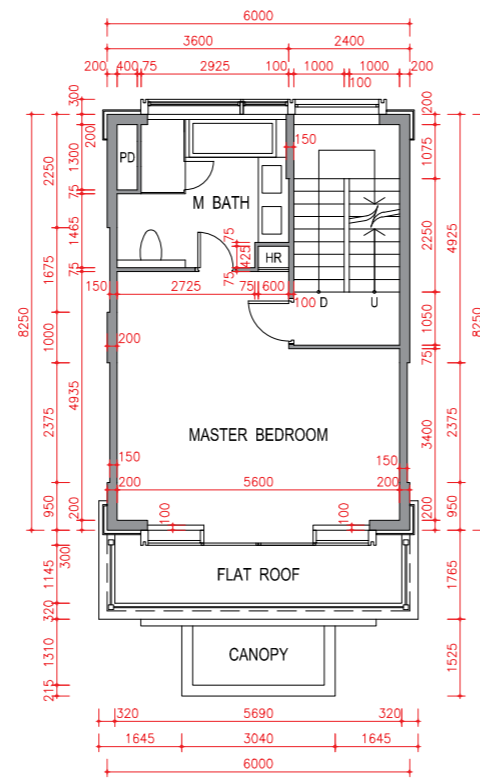
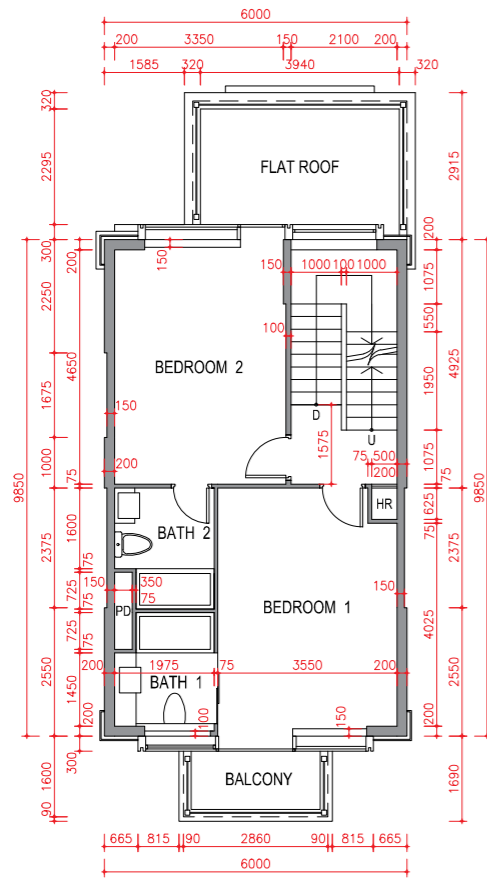
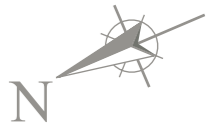

Upper Roof Plan
上層天台平面圖

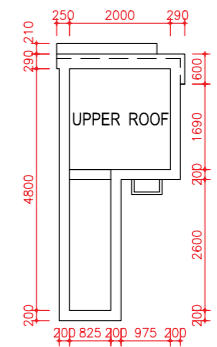
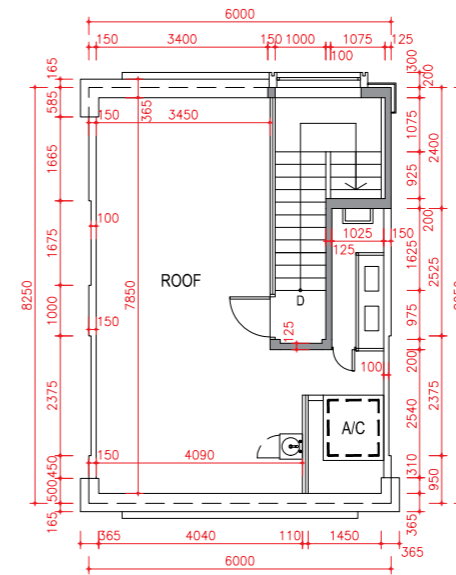
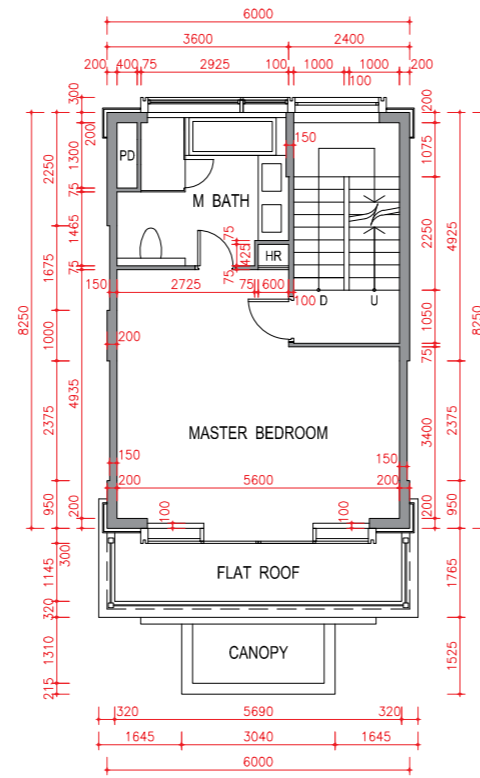
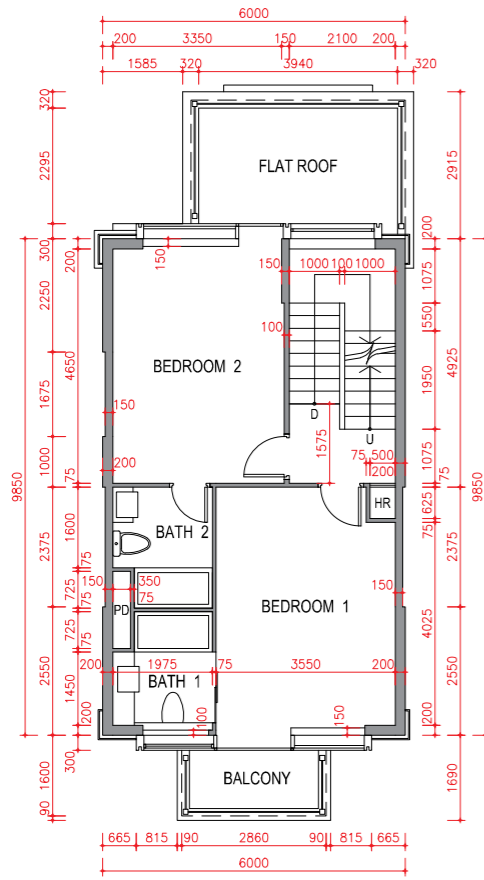
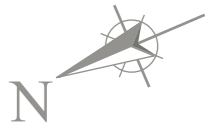

Upper Roof Plan
上層天台平面圖

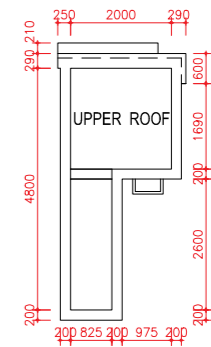
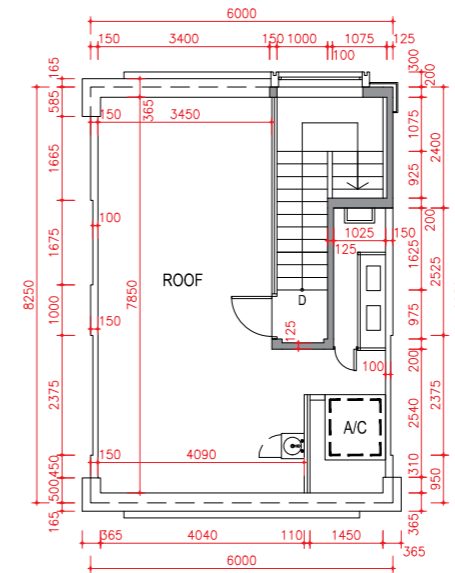
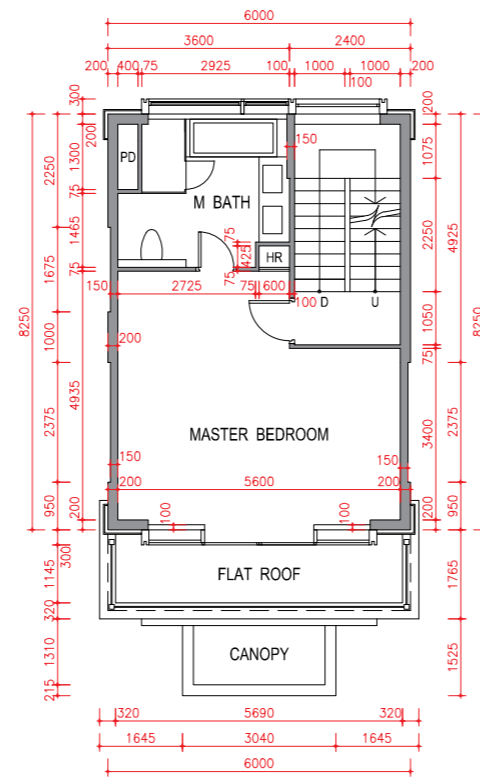
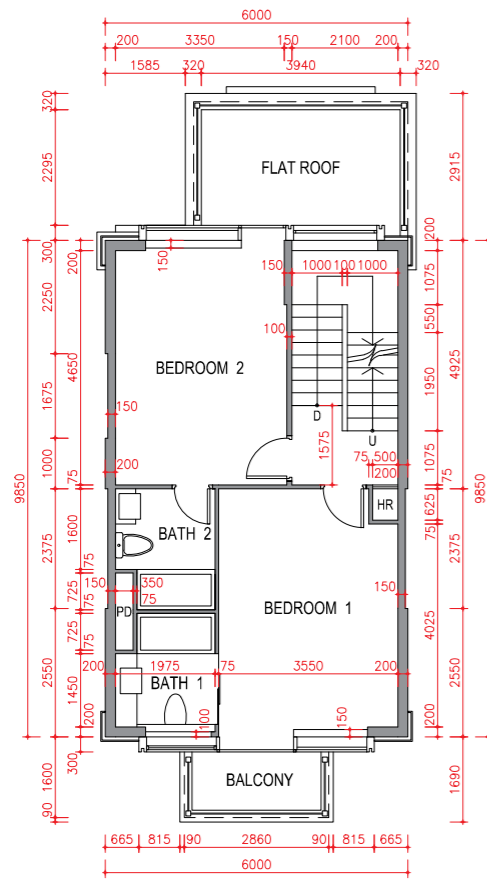
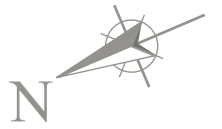

Upper Roof Plan
上層天台平面圖

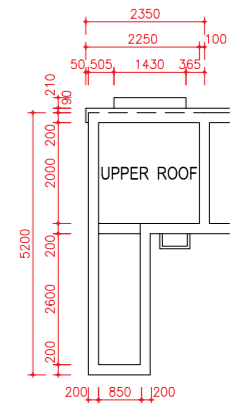
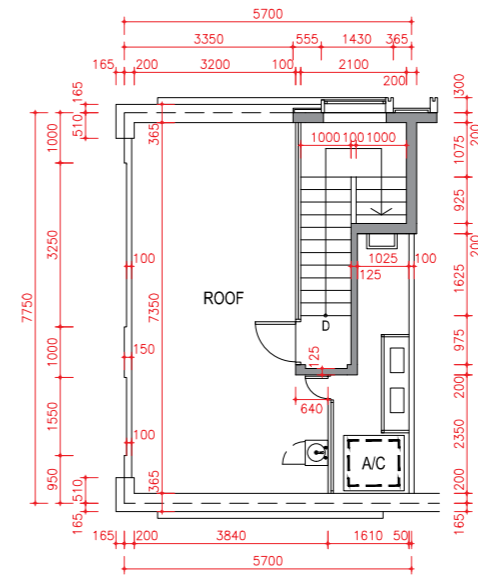
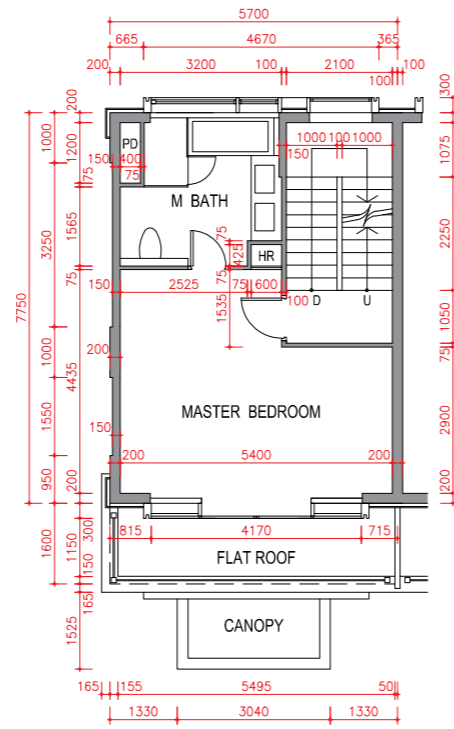
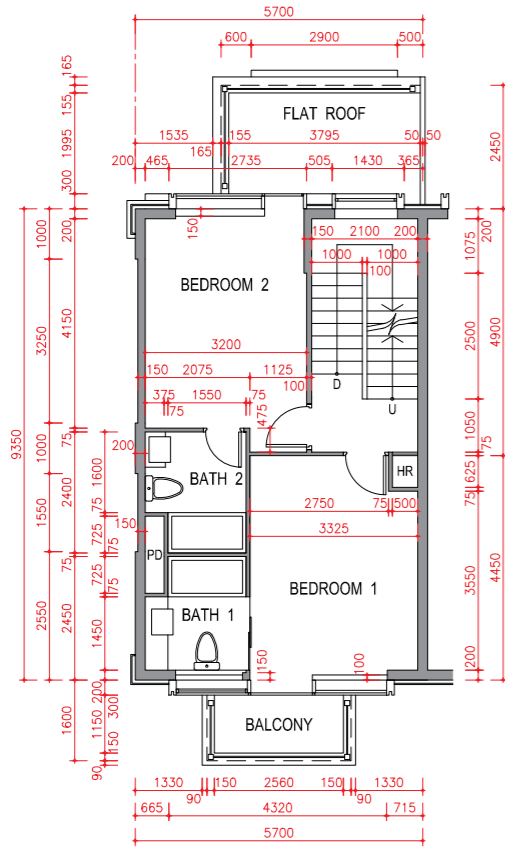
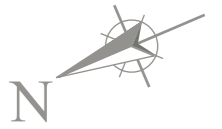

Upper Roof Plan
上層天台平面圖

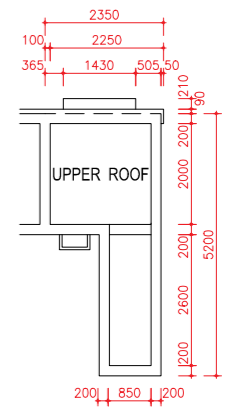
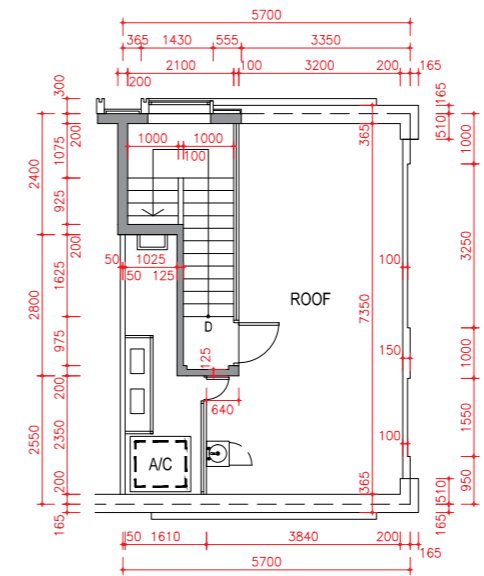
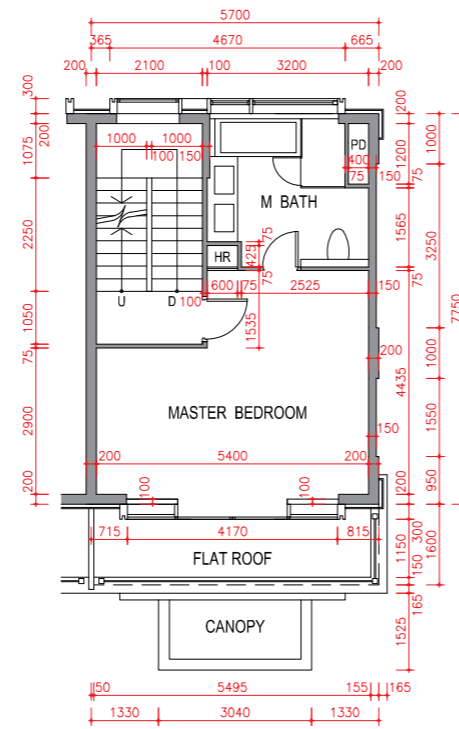
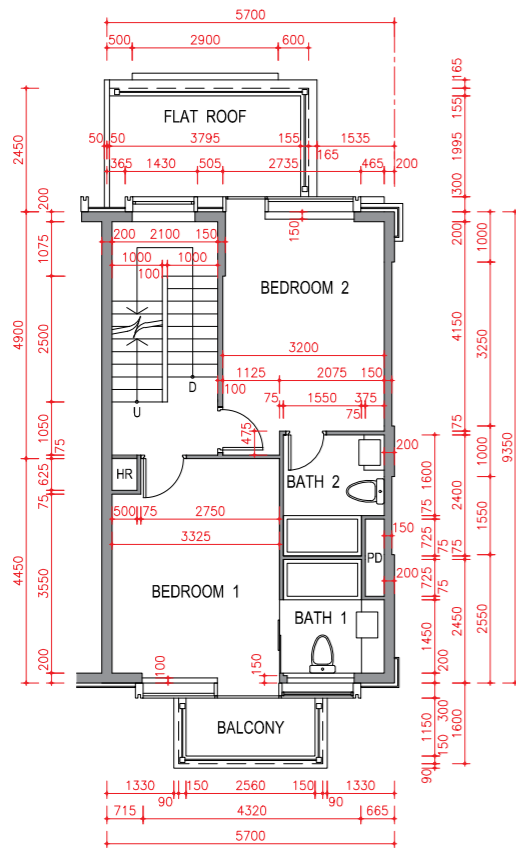
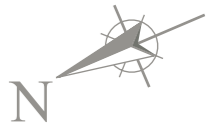

Upper Roof Plan
上層天台平面圖

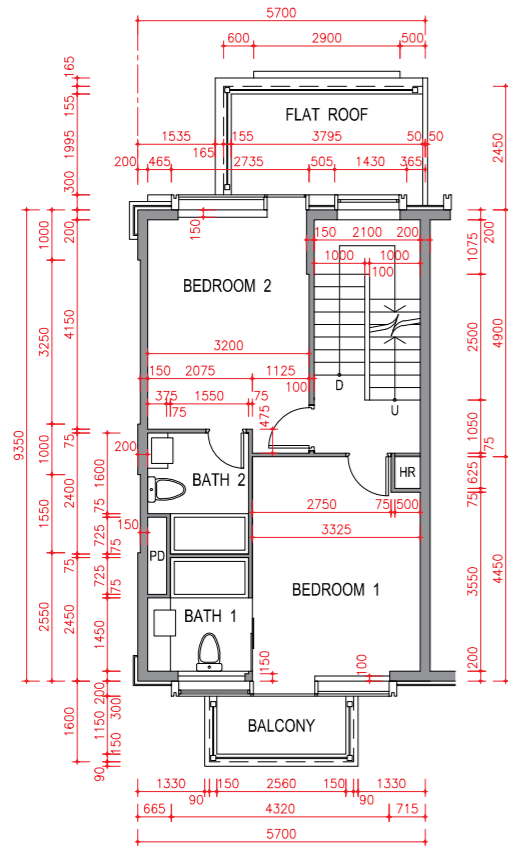
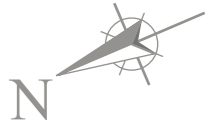

1/F Plan
一樓平面圖

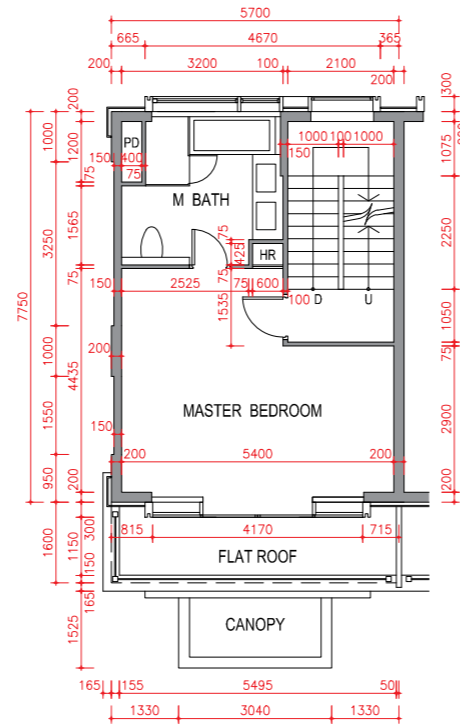

2/F Plan
二樓平面圖

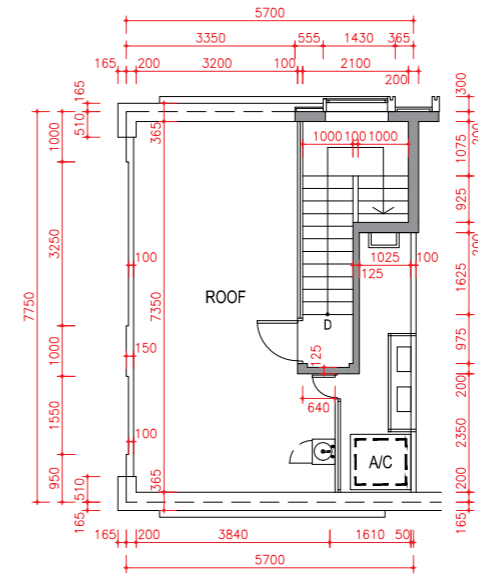

Roof Plan
天台平面圖

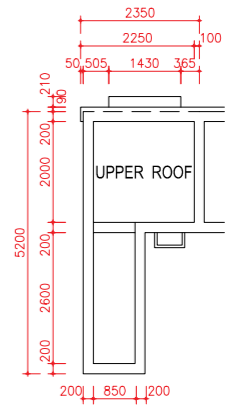

Upper Roof Plan
上層天台平面圖

79D Tan Kwai Tsuen Road, Casa Regalia 富豪·悅庭丹桂村路 79D 號



Floor 樓層	The thickness of the floor slabs (excluding plaster) of each House (mm) 每座洋房的樓板(不包括灰泥)的厚度(毫米)	The floor-to-floor height of each House (mm) 每座洋房的層與層之間的高度(毫米)
Basement 地下樓層	-	3650
G/F 地下	150, 175	4150
1/F 一樓	150, 175	3400
2/F 二樓	150	3400
Roof 天台	150	2825

The internal areas of the residential properties on the upper floors will generally be slightly larger than those on the lower floors because of the reducing thickness of the structural walls on the upper floors.

因住宅物業的較高樓層的結構牆的厚度遞減，較高樓層的內部面積，一般比較低樓層的內部面積稍大。

Notes:

- The dimensions of floor plans are all structural dimensions in millimeter.
- There may be architectural features and/or exposed pipes on external walls of DOMUS/Houses. For details, please refer to the latest approved building plans.
- Common pipes exposed and/or enclosed in cladding are located at/adjacent to flat roof and/or external wall of DOMUS/Houses. For details, please refer to the latest approved building plans.
- There are ceiling bulkheads and/or sunken slab of the above Flats/Houses at living/dining room, bedrooms, corridors and/or kitchen of the above Flats/Houses for the air-conditioning system and/or mechanical and electrical services.
- Please refer to page 20 of this sales brochure for legend of the terms and abbreviations shown in the floor plan above.
- Under Special Condition No. (9)(g) of the Land Grant, the total number of residential units erected or to be erected on the Lot shall not be less than 170.
- According to Clause 55 of the Third Schedule to the DMC, no Owner shall demolish or alter the partition walls separating two Residential Units (as defined in the DMC) or a common wall dividing the land upon which two Houses (as defined in the DMC) are constructed or the floor slabs or roof slabs between two Residential Units which will result in such Residential Units being internally linked to and accessible from each other, except with the prior written consent of the Director of Lands or other Government authority in place of him from time to time.

備註：

- 平面圖所列之尺寸數字為以毫米標示之建築尺寸。
- 尚築及洋房外牆設有建築裝飾及/或外露喉管。詳細資料請參考最新批准之建築圖則。
- 尚築及洋房的平台及/或外牆設有外露及/或外牆裝飾板內藏之公用喉管。詳細資料請參考最新批准的建築圖則。
- 大樓及洋房客/飯廳、睡房、走廊及/或廚房有假天花及/或有跌級樓板以內藏冷氣系統及/或機電設備。
- 以上平面圖中顯示之名詞及簡稱請參閱本售樓書第20頁。
- 批地文件特別條款第(9)(g)條規定，在該地段已建或擬建的住宅單位不得少於170個。
- 根據公契附表3第55條，除非已事先獲得地政總署署長或取代地政總署署長的其他政府機構不時作出的同意，否則任何業主不得拆卸或變更分隔兩個住宅單位(定義見公契)的間隔牆、分隔兩間洋房(定義見公契)土地的公用牆、或兩個住宅單位之間的水泥板或屋頂板以致使該等住宅單位能夠在內部連接及互通。

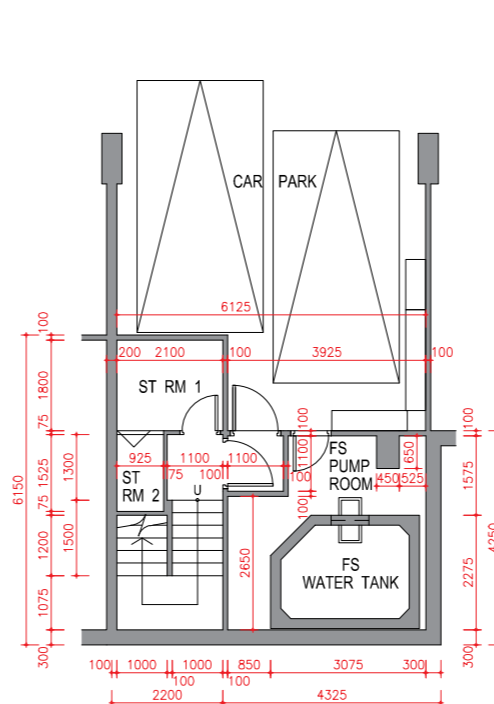

Basement Plan
地庫平面圖

79C Tan Kwai Tsuen Road
Casa Regalia
富豪·悅庭
丹桂村路 79C 號

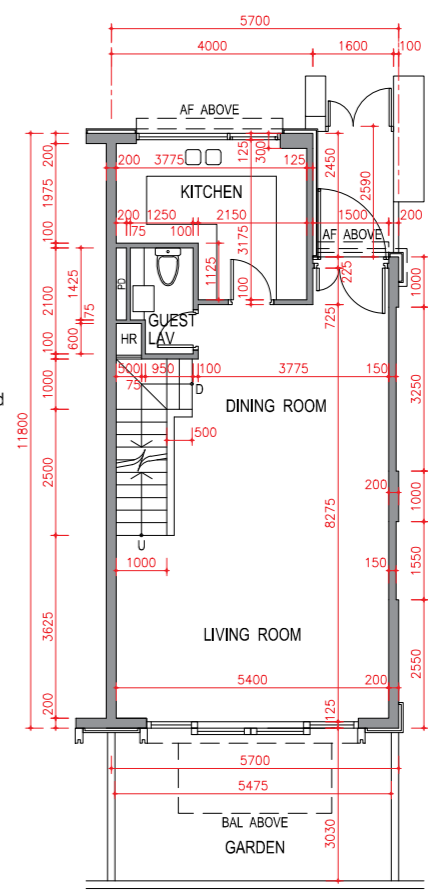

G/F Plan
地面層平面圖

79E Tan Kwai Tsuen Road
Casa Regalia
富豪·悅庭
丹桂村路 79E 號

Scale: 0M / 米 5M / 米
比例:

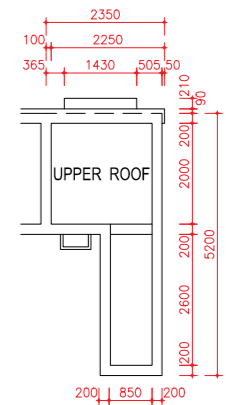
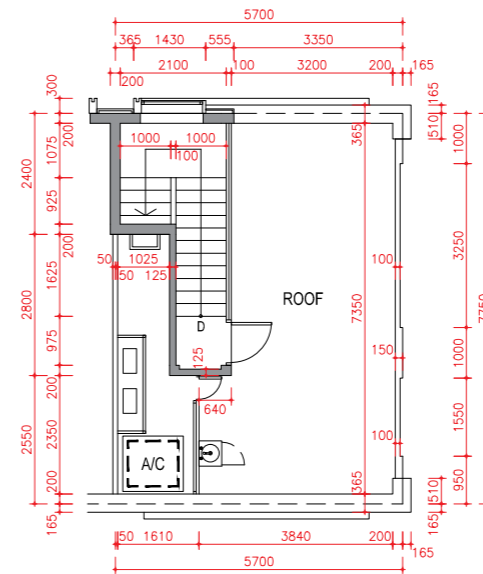
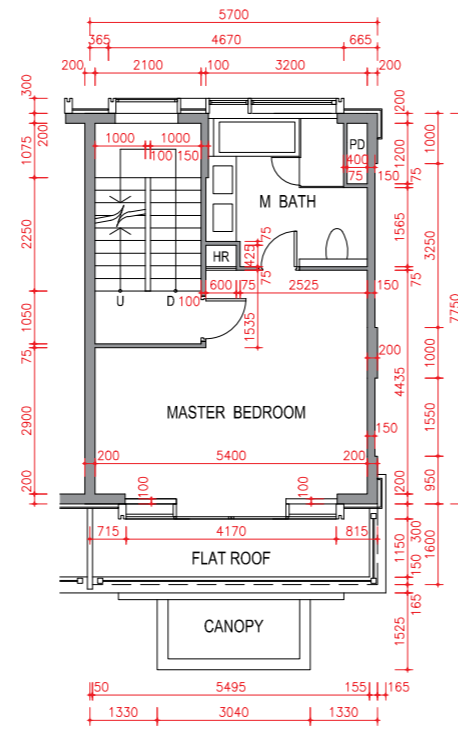
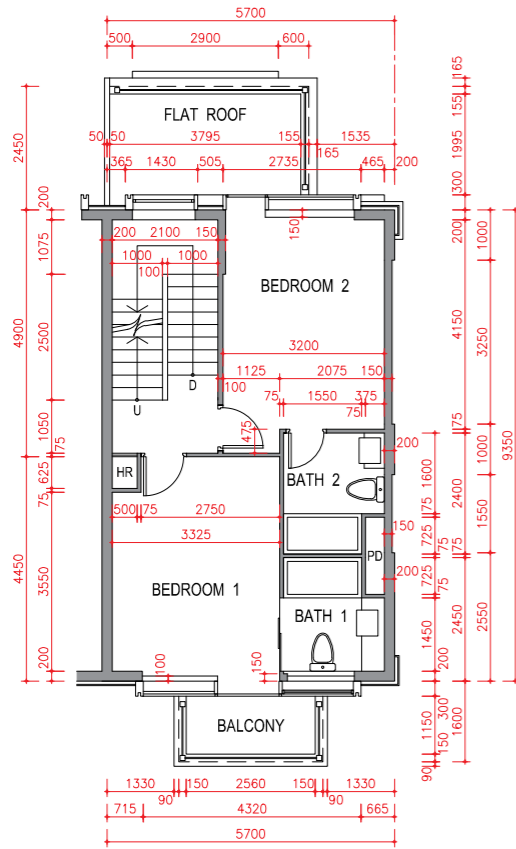
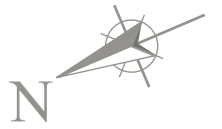

Upper Roof Plan
上層天台平面圖

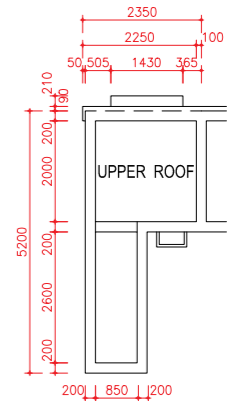
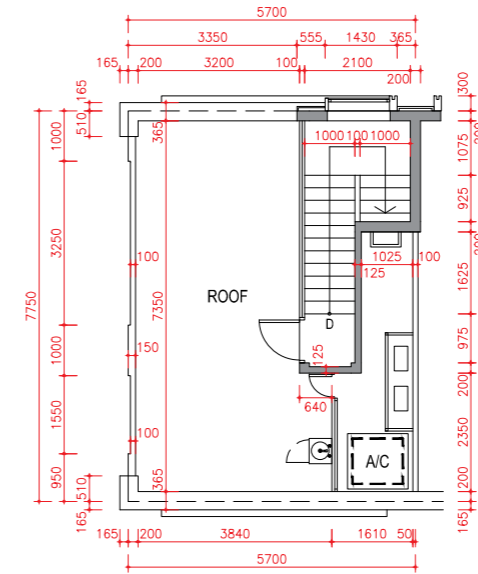
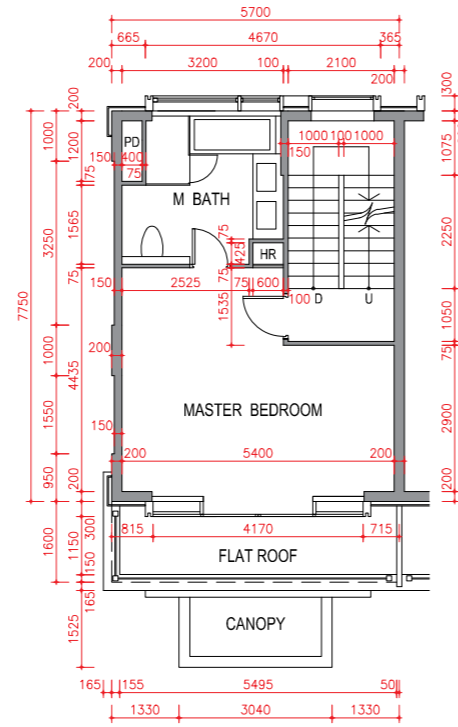
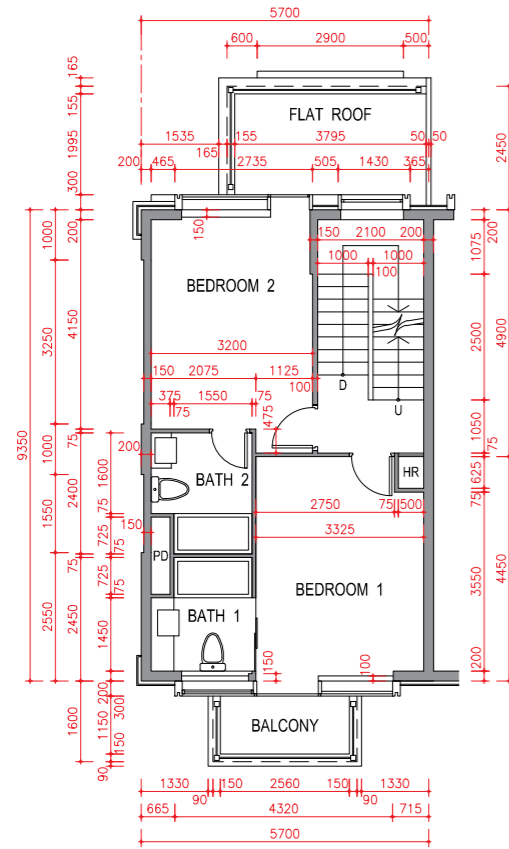
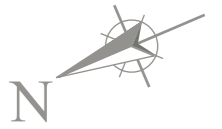

Upper Roof Plan
上層天台平面圖

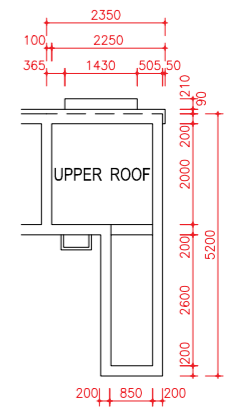
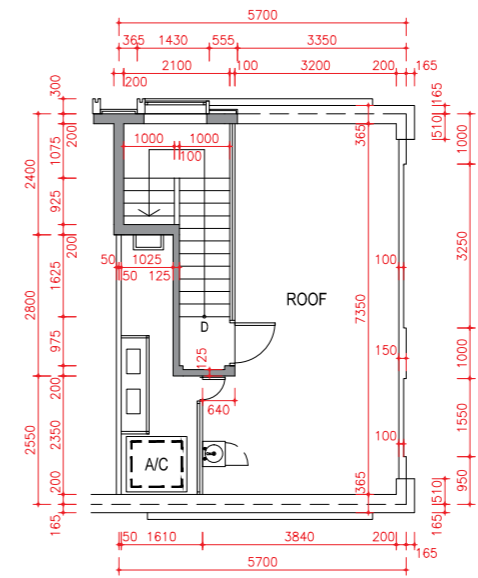
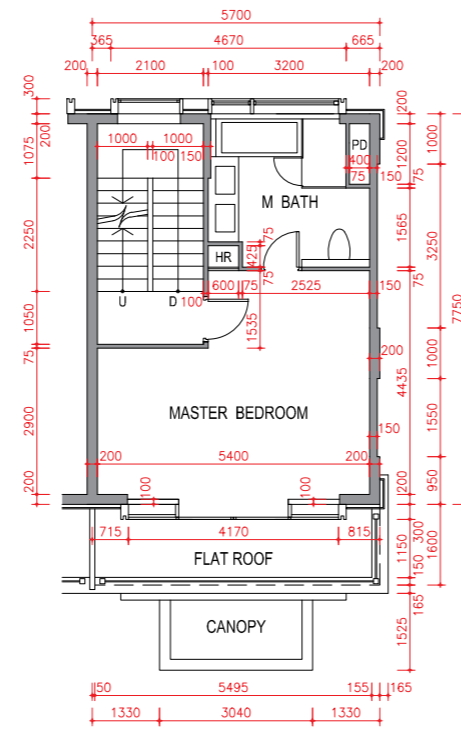
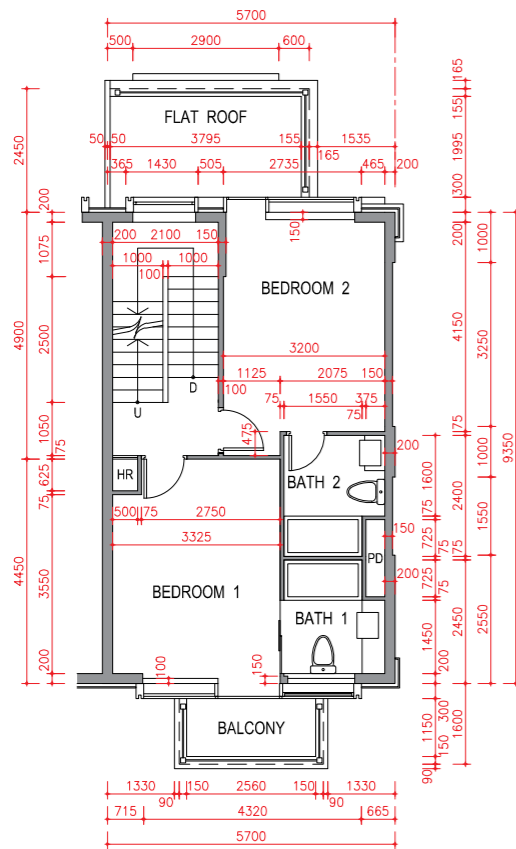
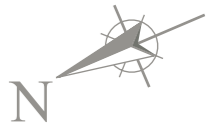

Upper Roof Plan
上層天台平面圖

81 Tan Kwai Tsuen Road, Casa Regalia 富豪·悦庭丹桂村路 81 號

Floor 樓層	The thickness of the floor slabs (excluding plaster) of each House (mm) 每座洋房的樓板(不包括灰泥)的厚度(毫米)	The floor-to-floor height of each House (mm) 每座洋房的層與層之間的高度(毫米)
Basement 地下樓層	-	3170
G/F 地下	150, 175	4200
1/F 一樓	150	3450
2/F 二樓	150, 175	3450
Roof 天台	150, 175	2825

The internal areas of the residential properties on the upper floors will generally be slightly larger than those on the lower floors because of the reducing thickness of the structural walls on the upper floors.

因住宅物業的較高樓層的結構牆的厚度遞減，較高樓層的內部面積，一般比較低樓層的內部面積稍大。

Notes:

- The dimensions of floor plans are all structural dimensions in millimeter.
- There may be architectural features and/or exposed pipes on external walls of DOMUS/Houses. For details, please refer to the latest approved building plans.
- Common pipes exposed and/or enclosed in cladding are located at/adjacent to flat roof and/or external wall of DOMUS/Houses. For details, please refer to the latest approved building plans.
- There are ceiling bulkheads and/or sunken slab of the above Flats/Houses at living/dining room, bedrooms, corridors and/or kitchen of the above Flats/Houses for the air-conditioning system and/or mechanical and electrical services.
- Please refer to page 20 of this sales brochure for legend of the terms and abbreviations shown in the floor plan above.
- Under Special Condition No. (9)(g) of the Land Grant, the total number of residential units erected or to be erected on the Lot shall not be less than 170.
- According to Clause 55 of the Third Schedule to the DMC, no Owner shall demolish or alter the partition walls separating two Residential Units (as defined in the DMC) or a common wall dividing the land upon which two Houses (as defined in the DMC) are constructed or the floor slabs or roof slabs between two Residential Units which will result in such Residential Units being internally linked to and accessible from each other, except with the prior written consent of the Director of Lands or other Government authority in place of him from time to time.

備註：

- 平面圖所列之尺寸數字為以毫米標示之建築尺寸。
- 尚築及洋房外牆設有建築裝飾及/或外露喉管。詳細資料請參考最新批准之建築圖則。
- 尚築及洋房的平台及/或外牆設有外露及/或外牆裝飾板內藏之公用喉管。詳細資料請參考最新批准的建築圖則。
- 大樓及洋房客/飯廳、睡房、走廊及/或廚房有假天花及/或有跌級樓板以內藏冷氣系統及/或機電設備。
- 以上平面圖中顯示之名詞及簡稱請參閱本售樓書第20頁。
- 批地文件特別條款第(9)(g)條規定，在該地段已建或擬建的住宅單位不得少於170個。
- 根據公契附表3第55條，除非已事先獲得地政總署署長或取代地政總署署長的其他政府機構不時作出的同意，否則任何業主不得拆卸或變更分隔兩個住宅單位(定義見公契)的間隔牆、分隔兩間洋房(定義見公契)土地的公用牆、或兩個住宅單位之間的水泥板或屋頂板以致使該等住宅單位能夠在內部連接及互通。

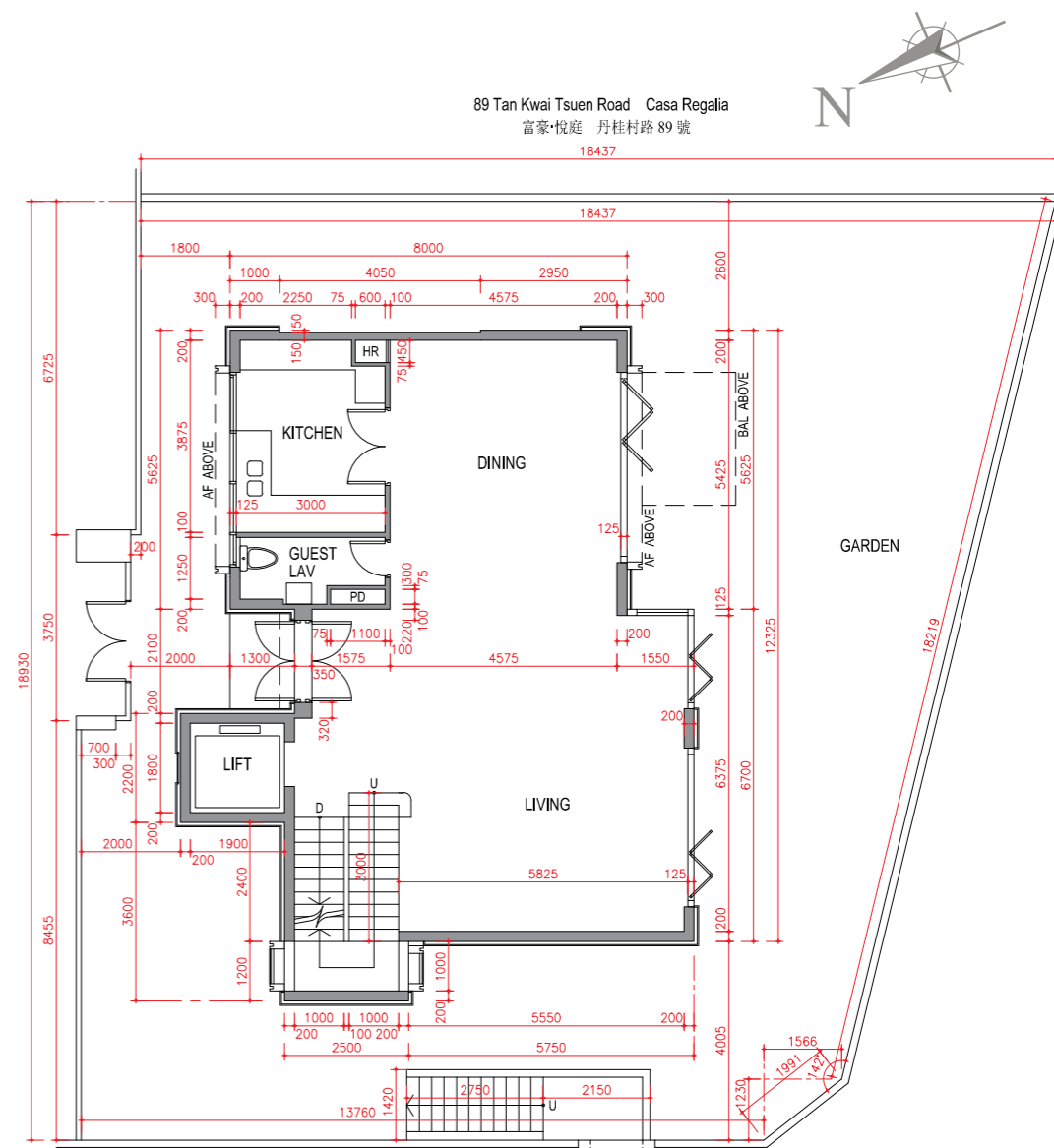

89 Tan Kwai Tsuen Road Casa Regalia
富豪·悦庭 丹桂村路 89 號

Entrance from
Tan Kwai
Tsuen Road
丹桂村路入口

G/F Plan
地面層平面圖

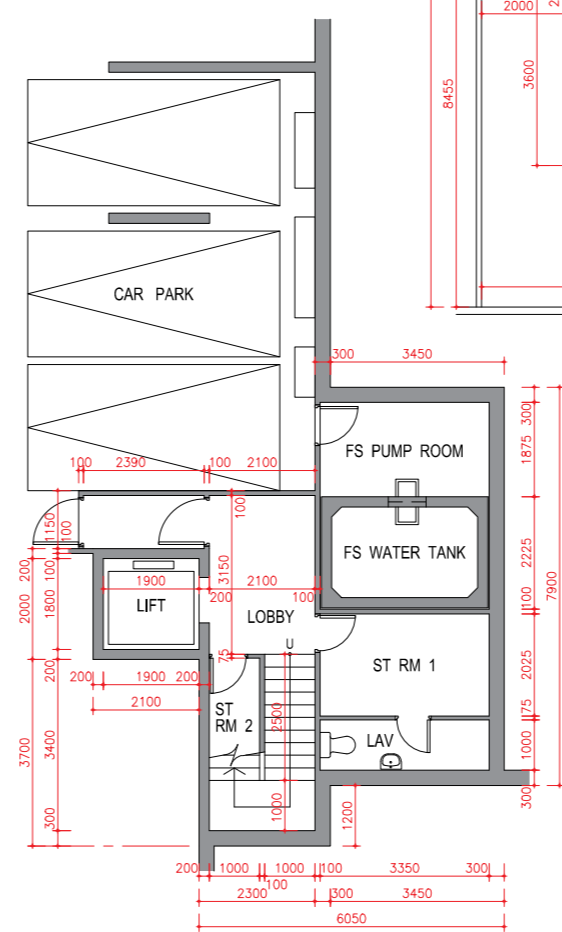

Basement Plan
地庫平面圖

Scale:
比例: 0M / 米 5M / 米

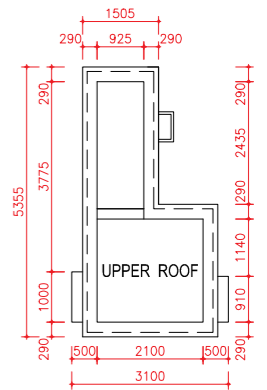
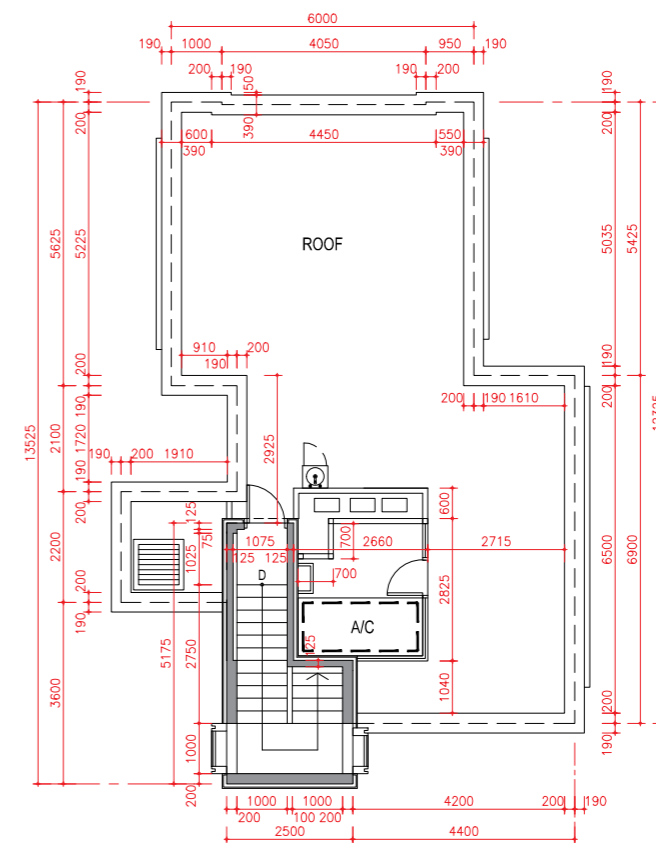
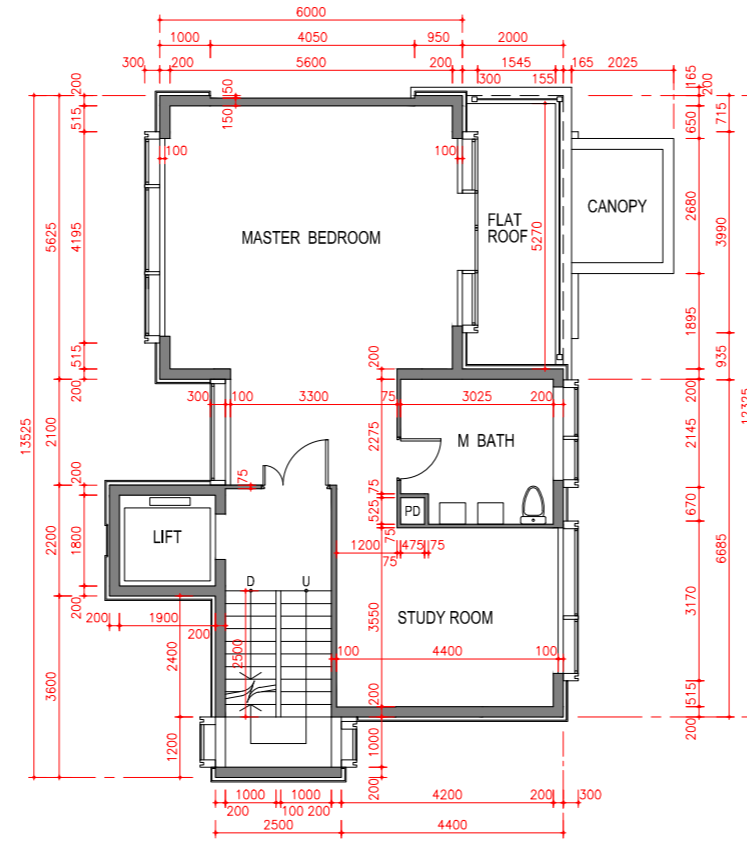
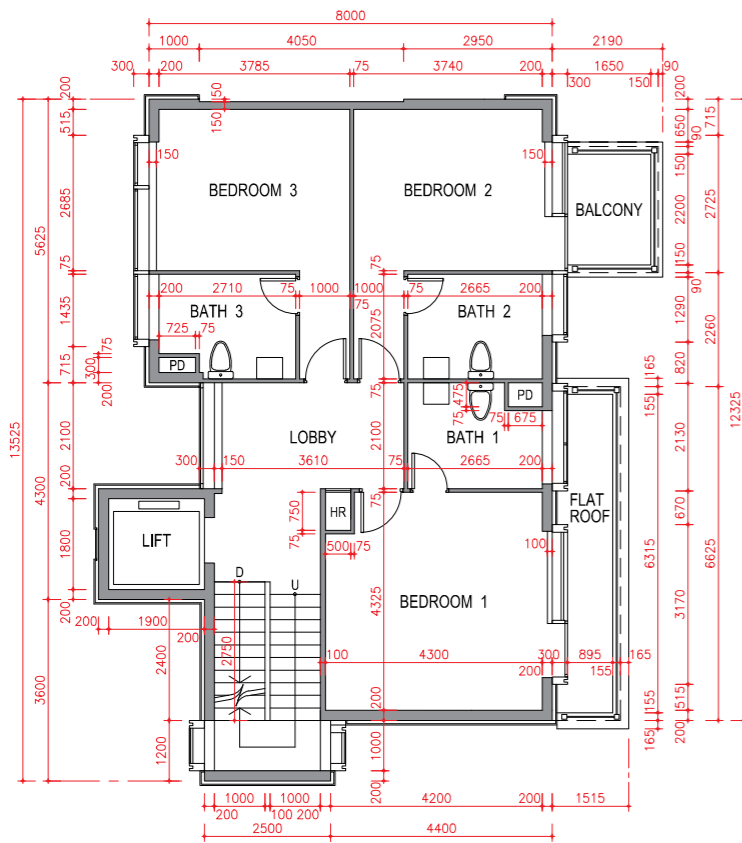
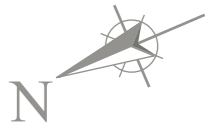

Upper Roof Plan
上層天台平面圖

1/F Plan
一樓平面圖

2/F Plan
二樓平面圖

Roof Plan
天台平面圖

0M / 米 5M / 米
Scale:
比例:

83A Tan Kwai Tsuen Road, Casa Regalia 富豪·悦庭丹桂村路 83A 號

Floor 樓層	The thickness of the floor slabs (excluding plaster) of each House (mm) 每座洋房的樓板(不包括灰泥)的厚度(毫米)	The floor-to-floor height of each House (mm) 每座洋房的層與層之間的高度(毫米)
Basement 地下樓層	-	3650
G/F 地下	150, 175	2950/4150
1/F 一樓	150	3400
2/F 二樓	150	3400
Roof 天台	150	2825

The internal areas of the residential properties on the upper floors will generally be slightly larger than those on the lower floors because of the reducing thickness of the structural walls on the upper floors.

因住宅物業的較高樓層的結構牆的厚度遞減，較高樓層的內部面積，一般比較低樓層的內部面積稍大。

Notes:

- The dimensions of floor plans are all structural dimensions in millimeter.
- There may be architectural features and/or exposed pipes on external walls of DOMUS/Houses. For details, please refer to the latest approved building plans.
- Common pipes exposed and/or enclosed in cladding are located at/adjacent to flat roof and/or external wall of DOMUS/Houses. For details, please refer to the latest approved building plans.
- There are ceiling bulkheads and/or sunken slab of the above Flats/Houses at living/dining room, bedrooms, corridors and/or kitchen of the above Flats/Houses for the air-conditioning system and/or mechanical and electrical services.
- Please refer to page 20 of this sales brochure for legend of the terms and abbreviations shown in the floor plan above.
- Under Special Condition No. (9)(g) of the Land Grant, the total number of residential units erected or to be erected on the Lot shall not be less than 170.
- According to Clause 55 of the Third Schedule to the DMC, no Owner shall demolish or alter the partition walls separating two Residential Units (as defined in the DMC) or a common wall dividing the land upon which two Houses (as defined in the DMC) are constructed or the floor slabs or roof slabs between two Residential Units which will result in such Residential Units being internally linked to and accessible from each other, except with the prior written consent of the Director of Lands or other Government authority in place of him from time to time.

備註：

- 平面圖所列之尺寸數字為以毫米標示之建築尺寸。
- 尚築及洋房外牆設有建築裝飾及/或外露喉管。詳細資料請參考最新批准之建築圖則。
- 尚築及洋房的平台及/或外牆設有外露及/或外牆裝飾板內藏之公用喉管。詳細資料請參考最新批准的建築圖則。
- 大樓及洋房客/飯廳、睡房、走廊及/或廚房有假天花及/或有跌級樓板以內藏冷氣系統及/或機電設備。
- 以上平面圖中顯示之名詞及簡稱請參閱本售樓書第20頁。
- 批地文件特別條款第(9)(g)條規定，在該地段已建或擬建的住宅單位不得少於170個。
- 根據公契附表3第55條，除非已事先獲得地政總署署長或取代地政總署署長的其他政府機構不時作出的同意，否則任何業主不得拆卸或變更分隔兩個住宅單位(定義見公契)的間隔牆、分隔兩間洋房(定義見公契)土地的公用牆、或兩個住宅單位之間的水泥板或屋頂板以致使該等住宅單位能夠在內部連接及互通。

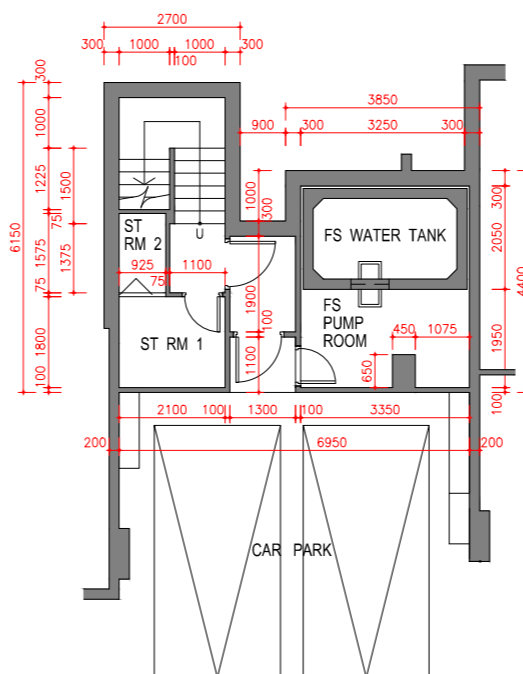

Basement Plan
地庫平面圖

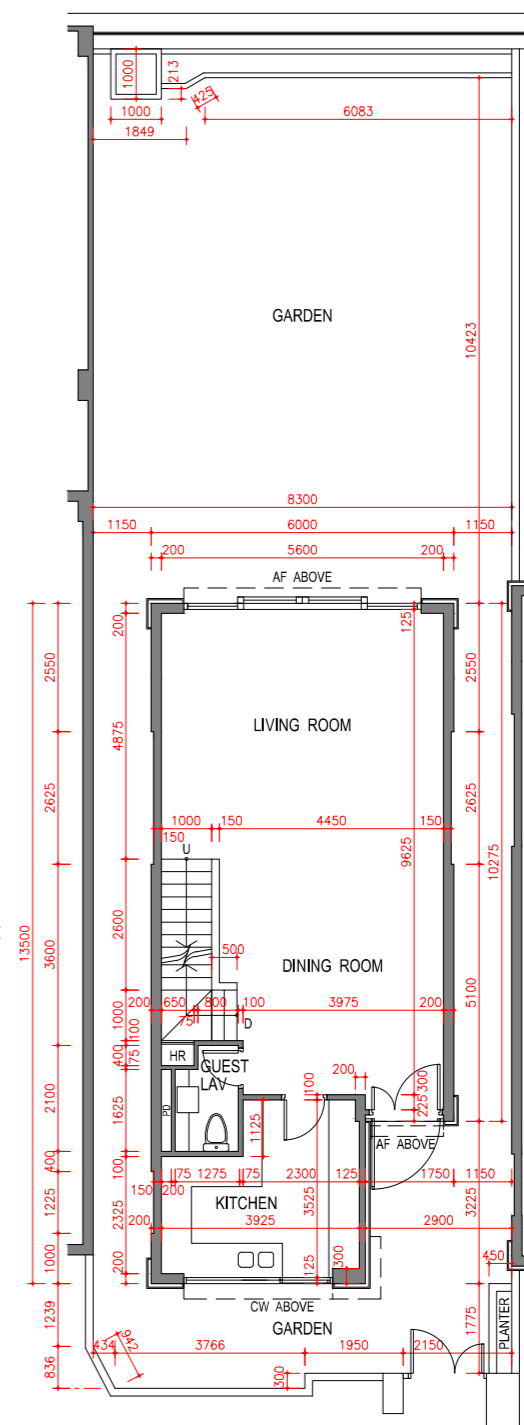

G/F Plan
地面層平面圖

83B Tan Kwai Tsuen Road
Casa Regalia
富豪·悦庭
丹桂村路 83B 號

0M / 米
Scale:
比例: 5M / 米

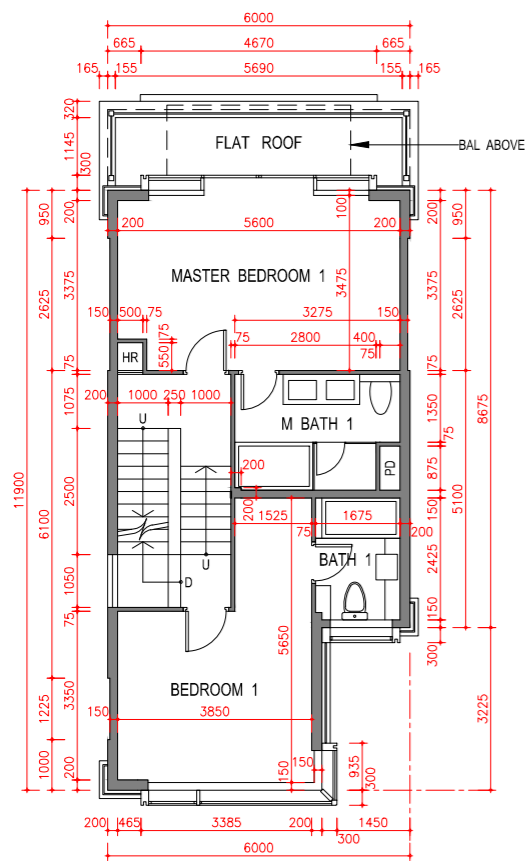
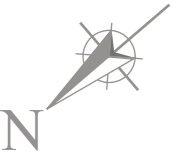

1/F Plan
一樓平面圖

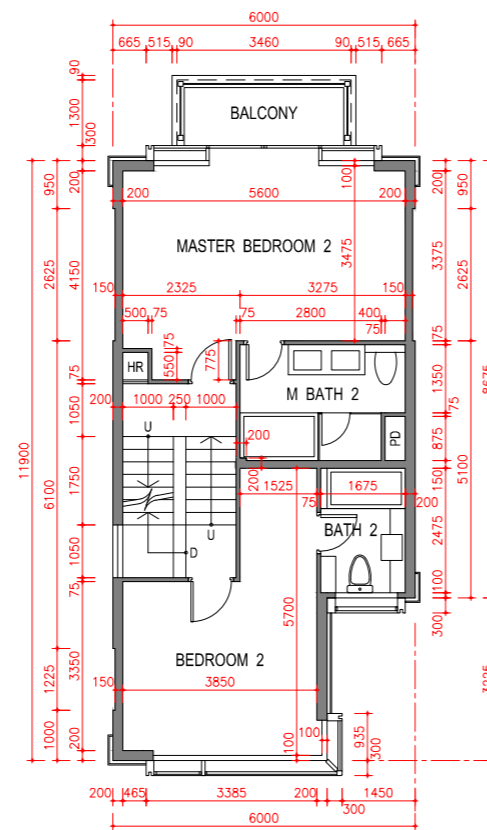

2/F Plan
二樓平面圖

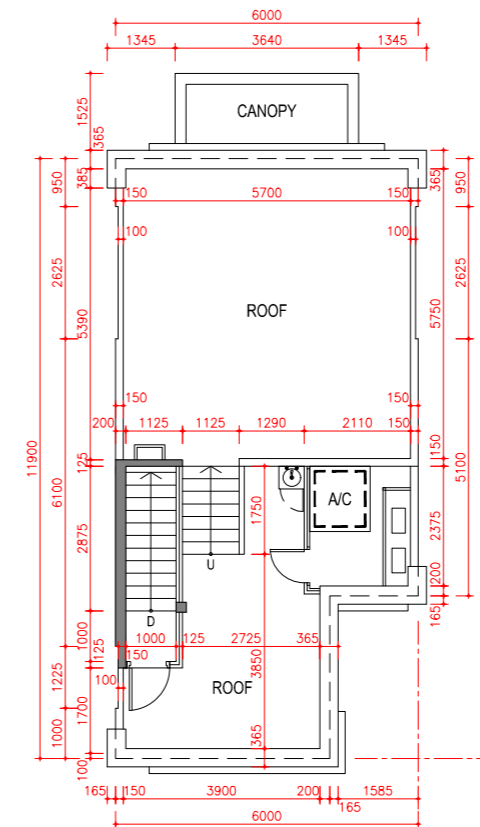

Roof Plan
天台平面圖

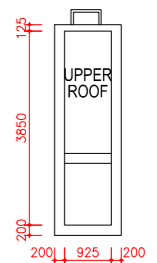

Upper Roof Plan
上層天台平面圖

0M / 米 5M / 米
Scale:
比例:

83B Tan Kwai Tsuen Road, Casa Regalia 富豪·悅庭丹桂村路 83B 號

Floor 樓層	The thickness of the floor slabs (excluding plaster) of each House (mm) 每座洋房的樓板(不包括灰泥)的厚度(毫米)	The floor-to-floor height of each House (mm) 每座洋房的層與層之間的高度(毫米)
Basement 地下樓層	-	3650
G/F 地下	150, 175	2950/4150
1/F 一樓	150	3400
2/F 二樓	150	3400
Roof 天台	150	2825

The internal areas of the residential properties on the upper floors will generally be slightly larger than those on the lower floors because of the reducing thickness of the structural walls on the upper floors.

因住宅物業的較高樓層的結構牆的厚度遞減，較高樓層的內部面積，一般比較低樓層的內部面積稍大。

Notes:

- The dimensions of floor plans are all structural dimensions in millimeter.
- There may be architectural features and/or exposed pipes on external walls of DOMUS/Houses. For details, please refer to the latest approved building plans.
- Common pipes exposed and/or enclosed in cladding are located at/adjacent to flat roof and/or external wall of DOMUS/Houses. For details, please refer to the latest approved building plans.
- There are ceiling bulkheads and/or sunken slab of the above Flats/Houses at living/dining room, bedrooms, corridors and/or kitchen of the above Flats/Houses for the air-conditioning system and/or mechanical and electrical services.
- Please refer to page 20 of this sales brochure for legend of the terms and abbreviations shown in the floor plan above.
- Under Special Condition No. (9)(g) of the Land Grant, the total number of residential units erected or to be erected on the Lot shall not be less than 170.
- According to Clause 55 of the Third Schedule to the DMC, no Owner shall demolish or alter the partition walls separating two Residential Units (as defined in the DMC) or a common wall dividing the land upon which two Houses (as defined in the DMC) are constructed or the floor slabs or roof slabs between two Residential Units which will result in such Residential Units being internally linked to and accessible from each other, except with the prior written consent of the Director of Lands or other Government authority in place of him from time to time.

備註：

- 平面圖所列之尺寸數字為以毫米標示之建築尺寸。
- 尚築及洋房外牆設有建築裝飾及/或外露喉管。詳細資料請參考最新批准之建築圖則。
- 尚築及洋房的平台及/或外牆設有外露及/或外牆裝飾板內藏之公用喉管。詳細資料請參考最新批准的建築圖則。
- 大樓及洋房客/飯廳、睡房、走廊及/或廚房有假天花及/或有跌級樓板以內藏冷氣系統及/或機電設備。
- 以上平面圖中顯示之名詞及簡稱請參閱本售樓書第20頁。
- 批地文件特別條款第(9)(g)條規定，在該地段已建或擬建的住宅單位不得少於170個。
- 根據公契附表3第55條，除非已事先獲得地政總署署長或取代地政總署署長的其他政府機構不時作出的同意，否則任何業主不得拆卸或變更分隔兩個住宅單位(定義見公契)的間隔牆、分隔兩間洋房(定義見公契)土地的公用牆、或兩個住宅單位之間的水泥板或屋頂板以致使該等住宅單位能夠在內部連接及互通。

Remark:

Alterations have been made to 83B Tan Kwai Tsuen Road, Casa Regalia, please refer to the "as-is" layout plans on Pages 66A and 66B for such alterations.

備註：

富豪·悅庭丹桂村路83B號經過改動，有關改動請參閱第66A及66B頁之現狀平面圖。

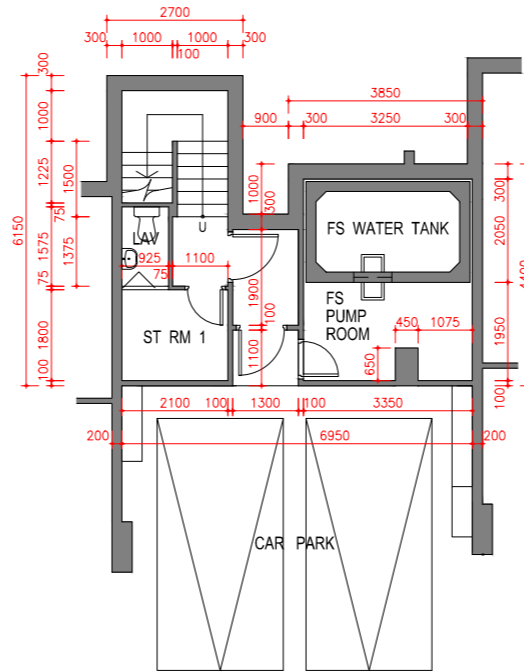

Basement Plan
地庫平面圖

83A Tan Kwai Tsuen Road
Casa Regalia
富豪·悅庭
丹桂村路 83A 號

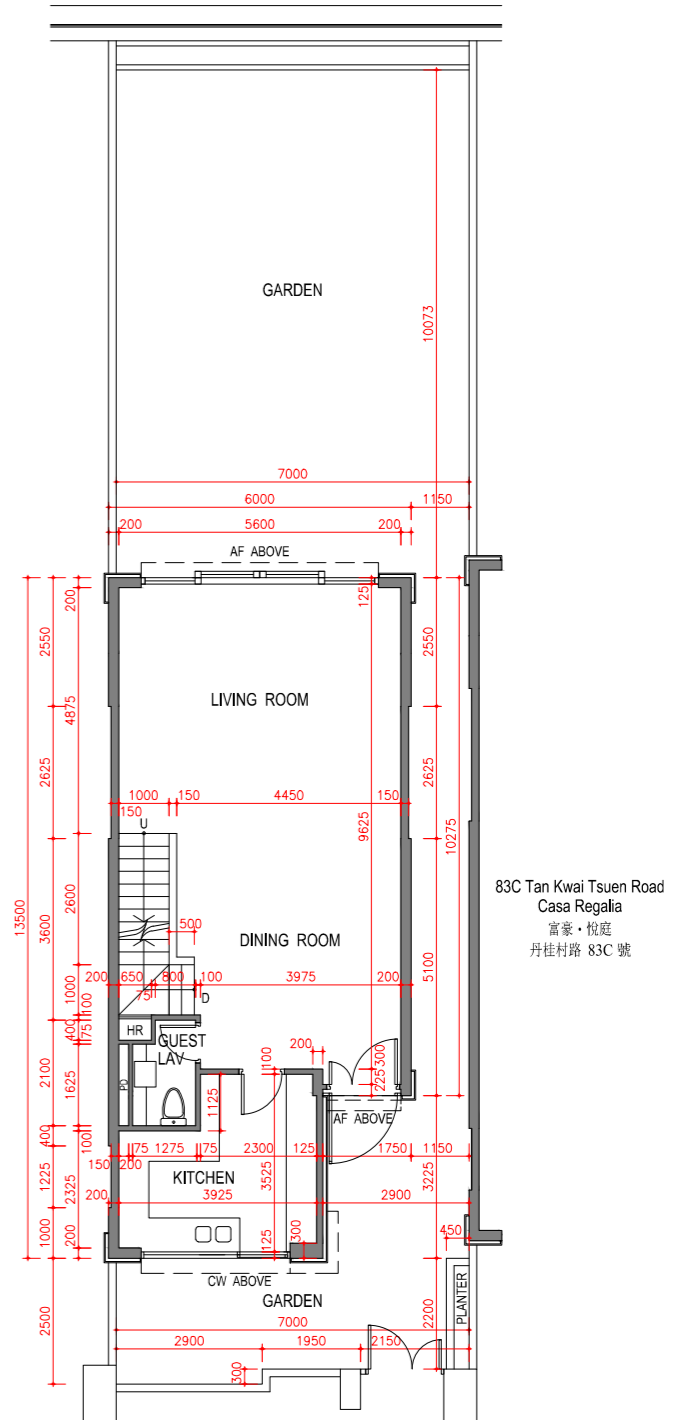

G/F Plan
地面層平面圖

83C Tan Kwai Tsuen Road
Casa Regalia
富豪·悅庭
丹桂村路 83C 號

Scale:
比例: 0M / 米 5M / 米



Remark:
Alterations have been made to 83B Tan Kwai Tsuen Road, Casa Regalia, please refer to the “as-is” layout plans on Pages 66A and 66B for such alterations.

備註:
富豪·悅庭丹桂村路83B號經過改動，有關改動請參閱第66A及66B頁之現狀平面圖。

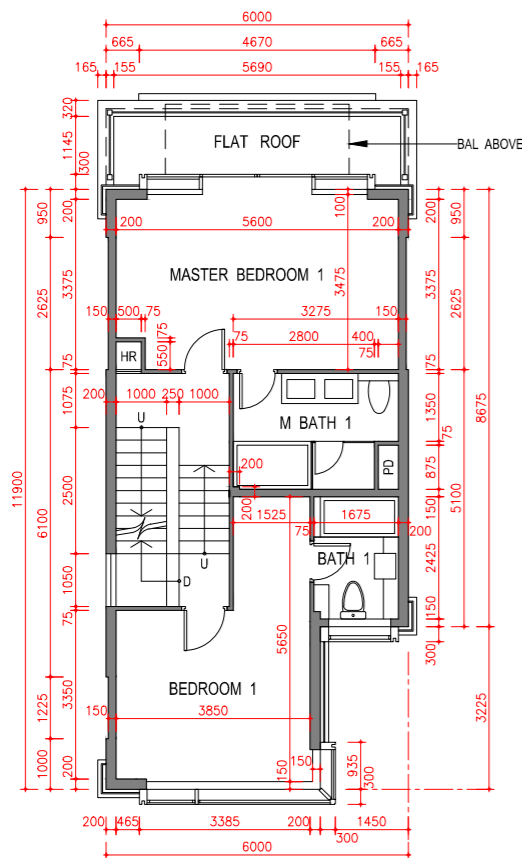

1/F Plan
一樓平面圖

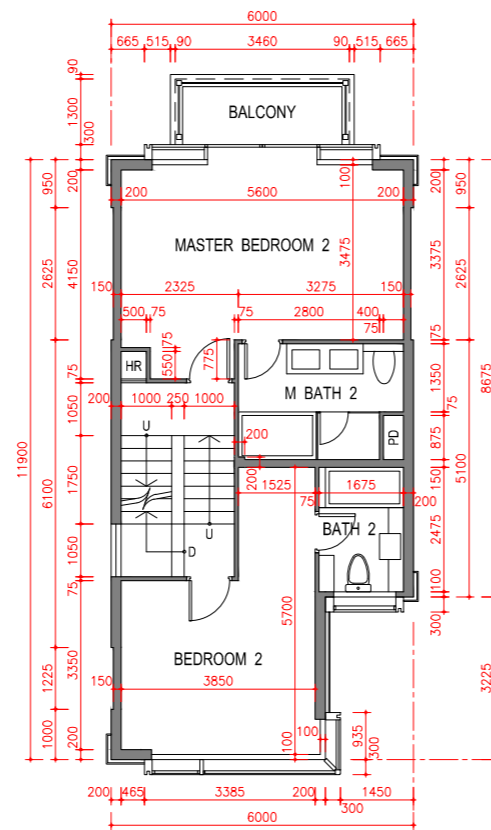

2/F Plan
二樓平面圖

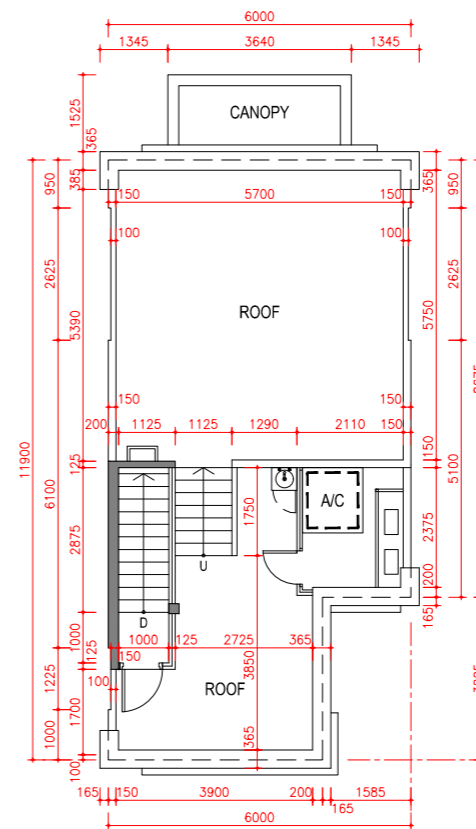

Roof Plan
天台平面圖

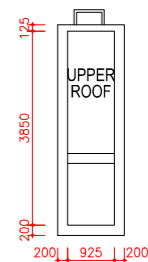

Upper Roof Plan
上層天台平面圖

0M / 米 5M / 米
Scale:
比例:

83B Tan Kwai Tsuen Road, Casa Regalia 富豪·悦庭丹桂村路 83B 號

Floor 樓層	The thickness of the floor slabs (excluding plaster) of each House (mm) 每座洋房的樓板(不包括灰泥)的厚度(毫米)	The floor-to-floor height of each House (mm) 每座洋房的層與層之間的高度(毫米)
Basement 地下樓層	-	3650
G/F 地下	150, 175	2950/4150
1/F 一樓	150	3400
2/F 二樓	150	3400
Roof 天台	150	2825

The internal areas of the residential properties on the upper floors will generally be slightly larger than those on the lower floors because of the reducing thickness of the structural walls on the upper floors.

因住宅物業的較高樓層的結構牆的厚度遞減，較高樓層的內部面積，一般比較低樓層的內部面積稍大。

Notes:

- The dimensions of floor plans are all structural dimensions in millimeter.
- There may be architectural features and/or exposed pipes on external walls of DOMUS/Houses. For details, please refer to the latest approved building plans.
- Common pipes exposed and/or enclosed in cladding are located at/adjacent to flat roof and/or external wall of DOMUS/Houses. For details, please refer to the latest approved building plans.
- There are ceiling bulkheads and/or sunken slab of the above Flats/Houses at living/dining room, bedrooms, corridors and/or kitchen of the above Flats/Houses for the air-conditioning system and/or mechanical and electrical services.
- Please refer to page 20 of this sales brochure for legend of the terms and abbreviations shown in the floor plan above.
- Under Special Condition No. (9)(g) of the Land Grant, the total number of residential units erected or to be erected on the Lot shall not be less than 170.
- According to Clause 55 of the Third Schedule to the DMC, no Owner shall demolish or alter the partition walls separating two Residential Units (as defined in the DMC) or a common wall dividing the land upon which two Houses (as defined in the DMC) are constructed or the floor slabs or roof slabs between two Residential Units which will result in such Residential Units being internally linked to and accessible from each other, except with the prior written consent of the Director of Lands or other Government authority in place of him from time to time.

備註：

- 平面圖所列之尺寸數字為以毫米標示之建築尺寸。
- 尚築及洋房外牆設有建築裝飾及/或外露喉管。詳細資料請參考最新批准之建築圖則。
- 尚築及洋房的平台及/或外牆設有外露及/或外牆裝飾板內藏之公用喉管。詳細資料請參考最新批准的建築圖則。
- 大樓及洋房客/飯廳、睡房、走廊及/或廚房有假天花及/或有跌級樓板以內藏冷氣系統及/或機電設備。
- 以上平面圖中顯示之名詞及簡稱請參閱本售樓書第20頁。
- 批地文件特別條款第(9)(g)條規定，在該地段已建或擬建的住宅單位不得少於170個。
- 根據公契附表3第55條，除非已事先獲得地政總署署長或取代地政總署署長的其他政府機構不時作出的同意，否則任何業主不得拆卸或變更分隔兩個住宅單位(定義見公契)的間隔牆、分隔兩間洋房(定義見公契)土地的公用牆、或兩個住宅單位之間的水泥板或屋頂板以致使該等住宅單位能夠在內部連接及互通。

Remark:
This page is the additional information mentioned in the Remark on Pages 65 and 66.

備註：
本頁是第65及66頁備註附加資料。

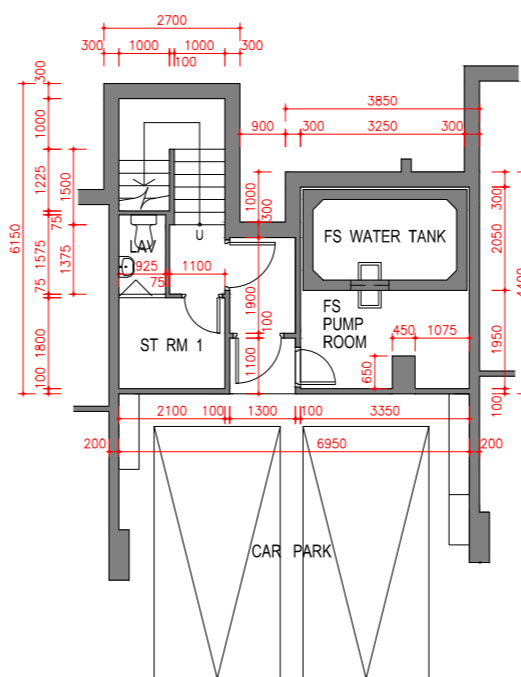

Basement Plan in "as-is" Layout
地庫現狀平面圖

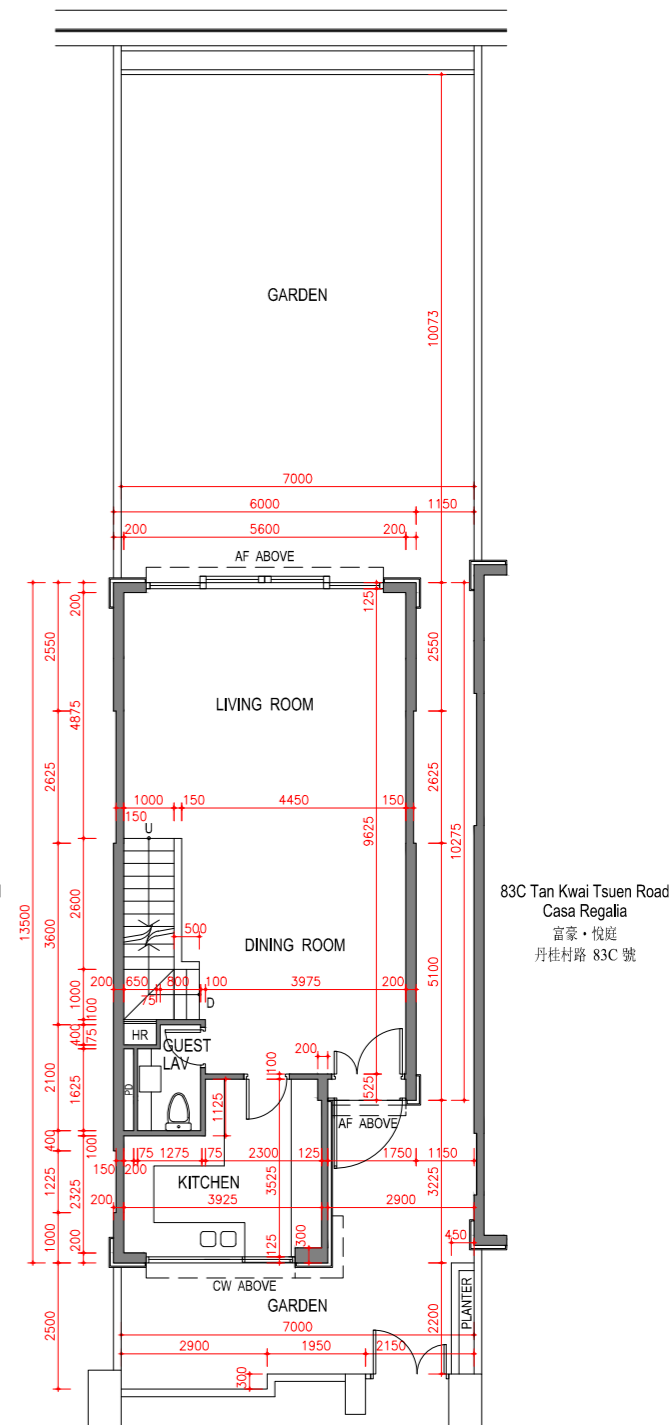

G/F Plan in "as-is" Layout
地面層現狀平面圖

83B Tan Kwai Tsuen Road, Casa Regalia has been altered by way of minor works and exempted works under the "Buildings Ordinance" after completion of the Development.
富豪·悦庭丹桂村路83B號在發展項目落成後進行小型工程及獲《建築物條例》豁免的工程。

0M / 米
Scale:
比例: 5M / 米



Remark:
This page is the additional information mentioned in the Remark on Pages 65 and 66.
備註:
本頁是第65及66頁備註附加資料。

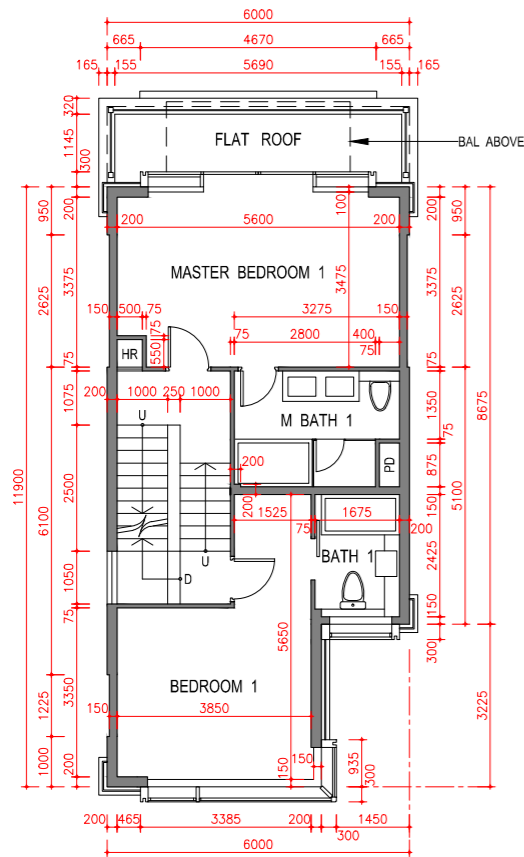

1/F Plan in "as-is" Layout
一樓現狀平面圖

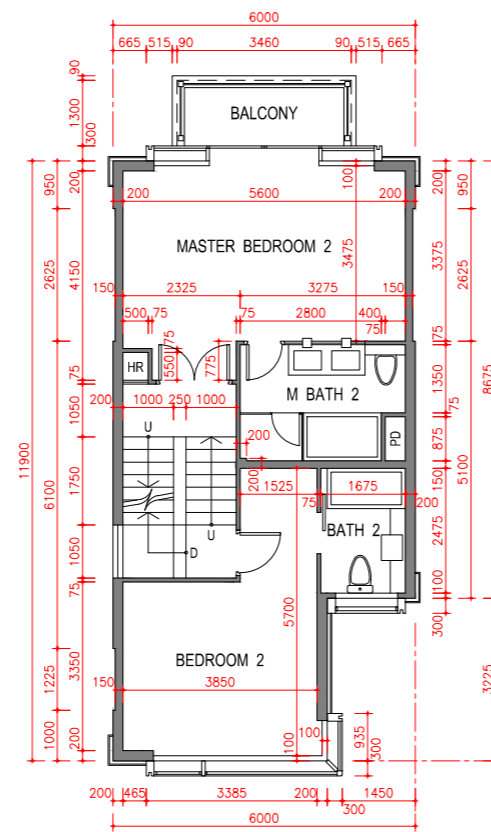

2/F Plan in "as-is" Layout
二樓現狀平面圖

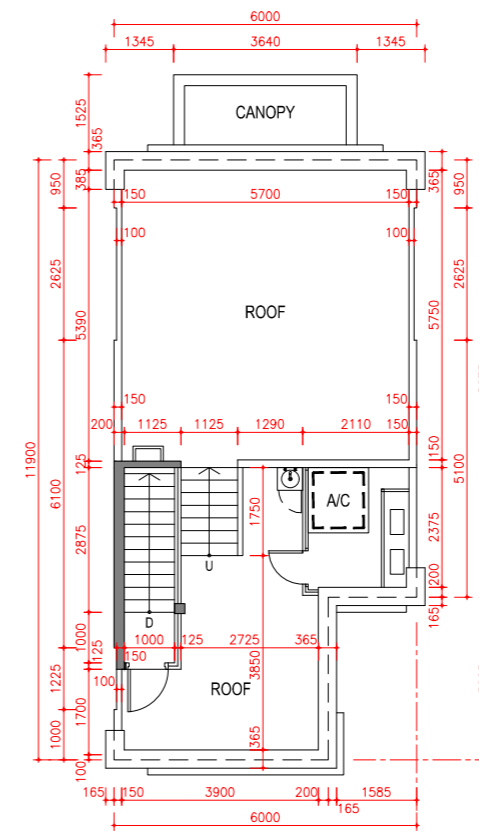

Roof Plan in "as-is" Layout
天台現狀平面圖

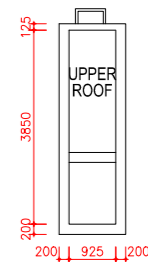

Upper Roof Plan in "as-is" Layout
上層天台現狀平面圖

83B Tan Kwai Tsuen Road, Casa Regalia has been altered by way of minor works and exempted works under the "Buildings Ordinance" after completion of the Development.
富豪·悅庭丹桂村路83B號在發展項目落成後進行小型工程及獲《建築物條例》豁免的工程。

0M / 米 5M / 米
Scale:
比例:

83C Tan Kwai Tsuen Road, Casa Regalia 富豪·悦庭丹桂村路 83C 號

Floor 樓層	The thickness of the floor slabs (excluding plaster) of each House (mm) 每座洋房的樓板(不包括灰泥)的厚度(毫米)	The floor-to-floor height of each House (mm) 每座洋房的層與層之間的高度(毫米)
Basement 地下樓層	-	3650
G/F 地下	150, 175	2950 / 4150
1/F 一樓	150	3400
2/F 二樓	150	3400
Roof 天台	150	2825

The internal areas of the residential properties on the upper floors will generally be slightly larger than those on the lower floors because of the reducing thickness of the structural walls on the upper floors.

因住宅物業的較高樓層的結構牆的厚度遞減，較高樓層的內部面積，一般比較低樓層的內部面積稍大。

Notes:

- The dimensions of floor plans are all structural dimensions in millimeter.
- There may be architectural features and/or exposed pipes on external walls of DOMUS/Houses. For details, please refer to the latest approved building plans.
- Common pipes exposed and/or enclosed in cladding are located at/adjacent to flat roof and/or external wall of DOMUS/Houses. For details, please refer to the latest approved building plans.
- There are ceiling bulkheads and/or sunken slab of the above Flats/Houses at living/dining room, bedrooms, corridors and/or kitchen of the above Flats/Houses for the air-conditioning system and/or mechanical and electrical services.
- Please refer to page 20 of this sales brochure for legend of the terms and abbreviations shown in the floor plan above.
- Under Special Condition No. (9)(g) of the Land Grant, the total number of residential units erected or to be erected on the Lot shall not be less than 170.
- According to Clause 55 of the Third Schedule to the DMC, no Owner shall demolish or alter the partition walls separating two Residential Units (as defined in the DMC) or a common wall dividing the land upon which two Houses (as defined in the DMC) are constructed or the floor slabs or roof slabs between two Residential Units which will result in such Residential Units being internally linked to and accessible from each other, except with the prior written consent of the Director of Lands or other Government authority in place of him from time to time.

備註：

- 平面圖所列之尺寸數字為以毫米標示之建築尺寸。
- 尚築及洋房外牆設有建築裝飾及/或外露喉管。詳細資料請參考最新批准之建築圖則。
- 尚築及洋房的平台及/或外牆設有外露及/或外牆裝飾板內藏之公用喉管。詳細資料請參考最新批准的建築圖則。
- 大樓及洋房客/飯廳、睡房、走廊及/或廚房有假天花及/或有跌級樓板以內藏冷氣系統及/或機電設備。
- 以上平面圖中顯示之名詞及簡稱請參閱本售樓書第20頁。
- 批地文件特別條款第(9)(g)條規定，在該地段已建或擬建的住宅單位不得少於170個。
- 根據公契附表3第55條，除非已事先獲得地政總署署長或取代地政總署署長的其他政府機構不時作出的同意，否則任何業主不得拆卸或變更分隔兩個住宅單位(定義見公契)的間隔牆、分隔兩間洋房(定義見公契)土地之公用牆、或兩個住宅單位之間的水泥板或屋頂板以致使該等住宅單位能夠在內部連接及互通。

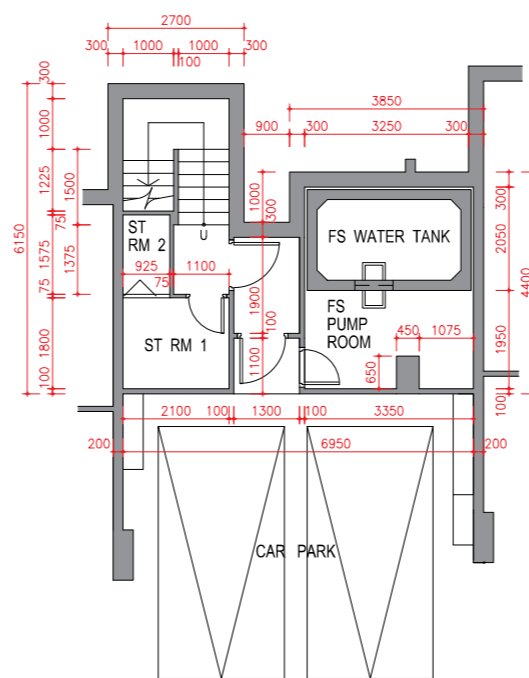

Basement Plan
地庫平面圖

83B Tan Kwai Tsuen Road
Casa Regalia
富豪·悦庭
丹桂村路 83B 號

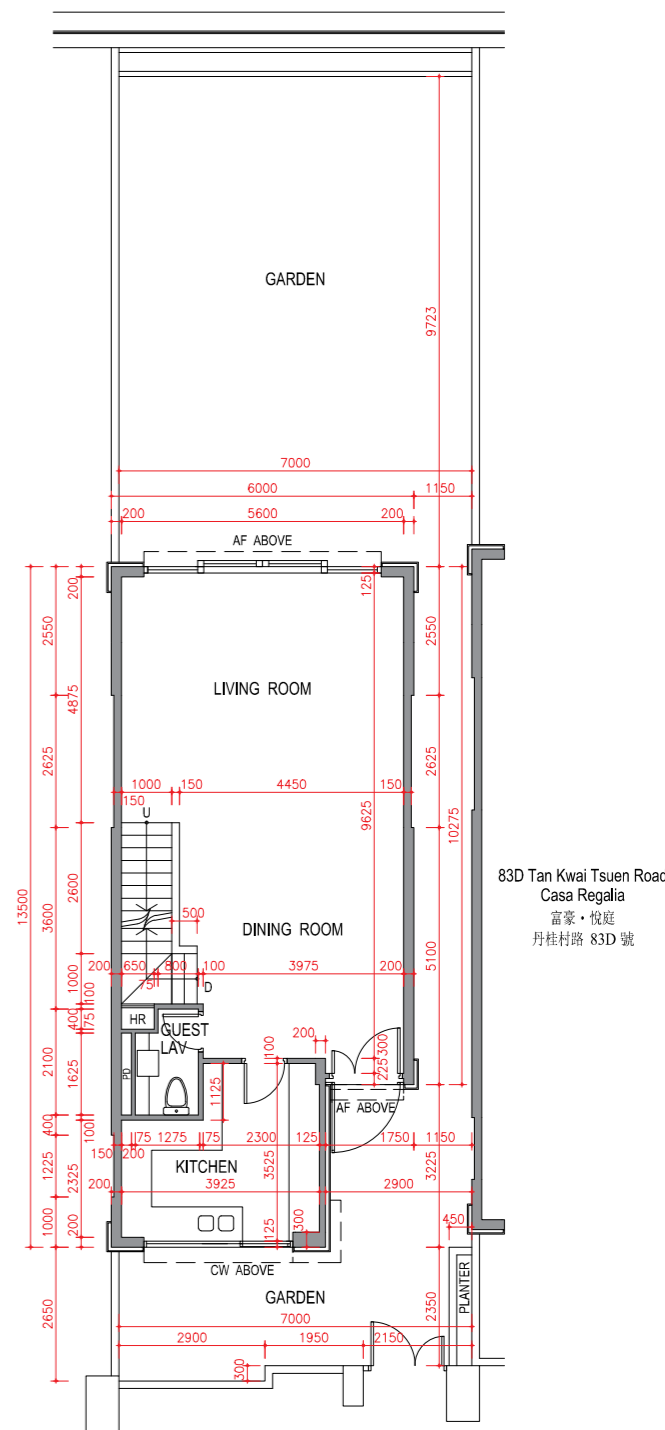

G/F Plan
地面層平面圖

Scale:
比例: 0M / 米 5M / 米

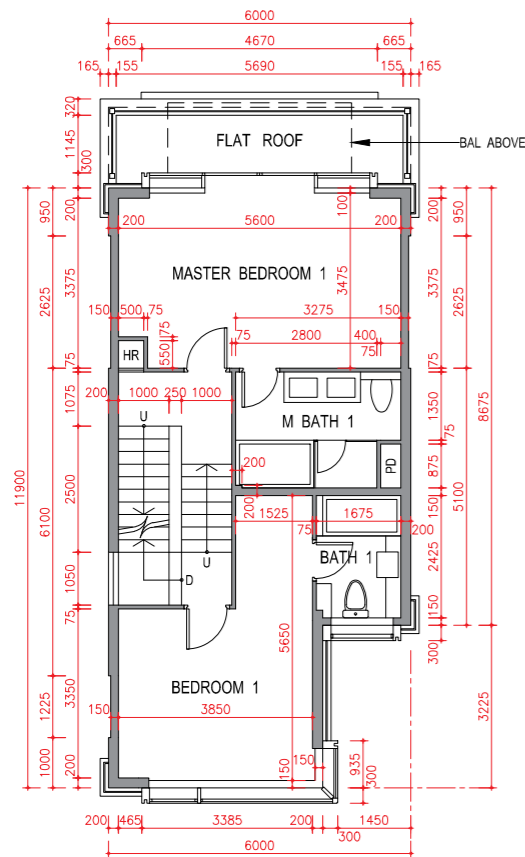
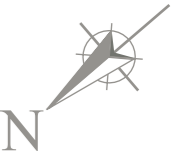

1/F Plan
一樓平面圖

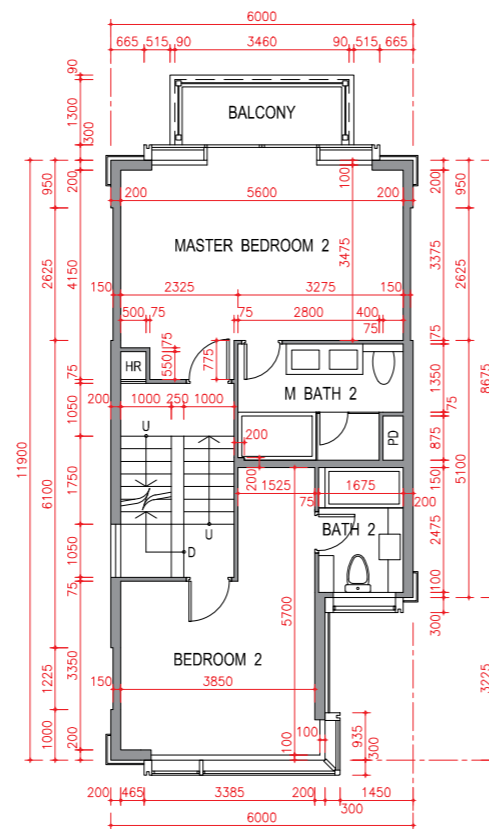

2/F Plan
二樓平面圖

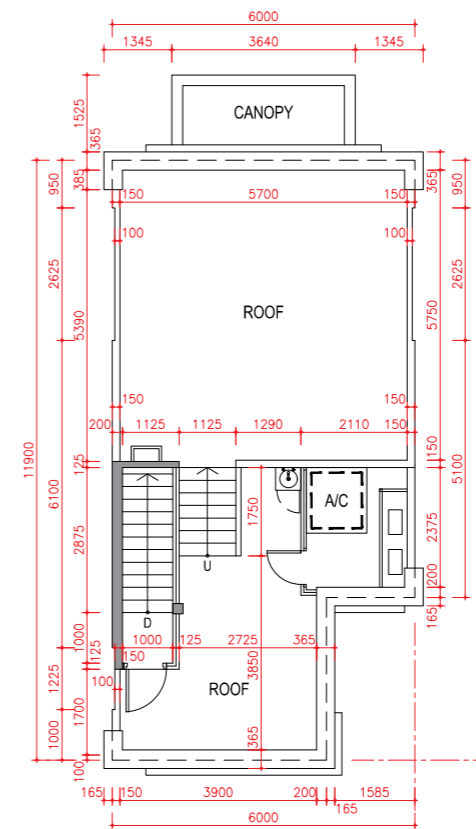

Roof Plan
天台平面圖

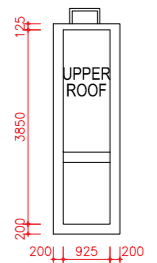

Upper Roof Plan
上層天台平面圖



83D Tan Kwai Tsuen Road, Casa Regalia 富豪·悅庭丹桂村路 83D 號

Floor 樓層	The thickness of the floor slabs (excluding plaster) of each House (mm) 每座洋房的樓板(不包括灰泥)的厚度(毫米)	The floor-to-floor height of each House (mm) 每座洋房的層與層之間的高度(毫米)
Basement 地下樓層	-	3650
G/F 地下	150, 175	2950/4150
1/F 一樓	150	3400
2/F 二樓	150	3400
Roof 天台	150	2825

The internal areas of the residential properties on the upper floors will generally be slightly larger than those on the lower floors because of the reducing thickness of the structural walls on the upper floors.

因住宅物業的較高樓層的結構牆的厚度遞減，較高樓層的內部面積，一般比較低樓層的內部面積稍大。

Notes:

- The dimensions of floor plans are all structural dimensions in millimeter.
- There may be architectural features and/or exposed pipes on external walls of DOMUS/Houses. For details, please refer to the latest approved building plans.
- Common pipes exposed and/or enclosed in cladding are located at/adjacent to flat roof and/or external wall of DOMUS/Houses. For details, please refer to the latest approved building plans.
- There are ceiling bulkheads and/or sunken slab of the above Flats/Houses at living/dining room, bedrooms, corridors and/or kitchen of the above Flats/Houses for the air-conditioning system and/or mechanical and electrical services.
- Please refer to page 20 of this sales brochure for legend of the terms and abbreviations shown in the floor plan above.
- Under Special Condition No. (9)(g) of the Land Grant, the total number of residential units erected or to be erected on the Lot shall not be less than 170.
- According to Clause 55 of the Third Schedule to the DMC, no Owner shall demolish or alter the partition walls separating two Residential Units (as defined in the DMC) or a common wall dividing the land upon which two Houses (as defined in the DMC) are constructed or the floor slabs or roof slabs between two Residential Units which will result in such Residential Units being internally linked to and accessible from each other, except with the prior written consent of the Director of Lands or other Government authority in place of him from time to time.

備註：

- 平面圖所列之尺寸數字為以毫米標示之建築尺寸。
- 尚築及洋房外牆設有建築裝飾及/或外露喉管。詳細資料請參考最新批准之建築圖則。
- 尚築及洋房的平台及/或外牆設有外露及/或外牆裝飾板內藏之公用喉管。詳細資料請參考最新批准的建築圖則。
- 大樓及洋房客/飯廳、睡房、走廊及/或廚房有假天花及/或有跌級樓板以內藏冷氣系統及/或機電設備。
- 以上平面圖中顯示之名詞及簡稱請參閱本售樓書第20頁。
- 批地文件特別條款第(9)(g)條規定，在該地段已建或擬建的住宅單位不得少於170個。
- 根據公契附表3第55條，除非已事先獲得地政總署署長或取代地政總署署長的其他政府機構不時作出的同意，否則任何業主不得拆卸或變更分隔兩個住宅單位(定義見公契)的間隔牆、分隔兩間洋房(定義見公契)土地的公用牆、或兩個住宅單位之間的水泥板或屋頂板以致使該等住宅單位能夠在內部連接及互通。

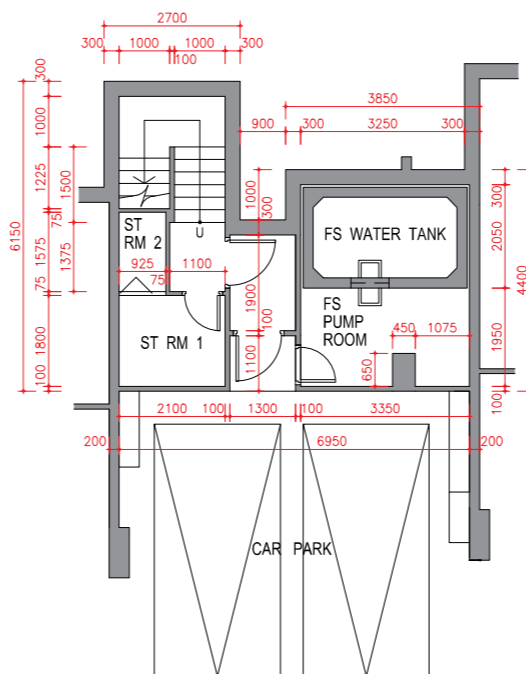

Basement Plan
地庫平面圖

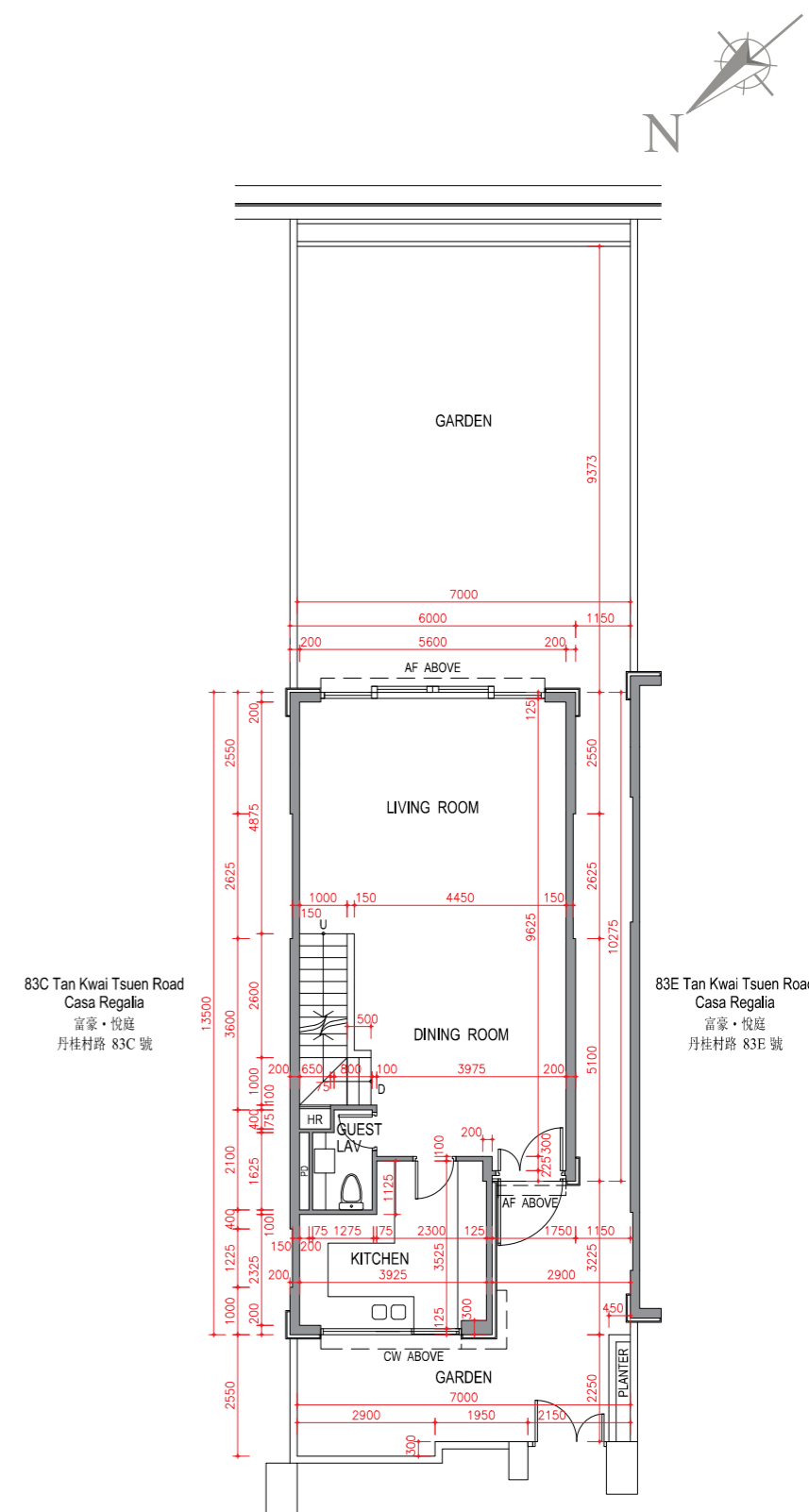

G/F Plan
地面層平面圖

0M / 米 5M / 米
Scale:
比例:

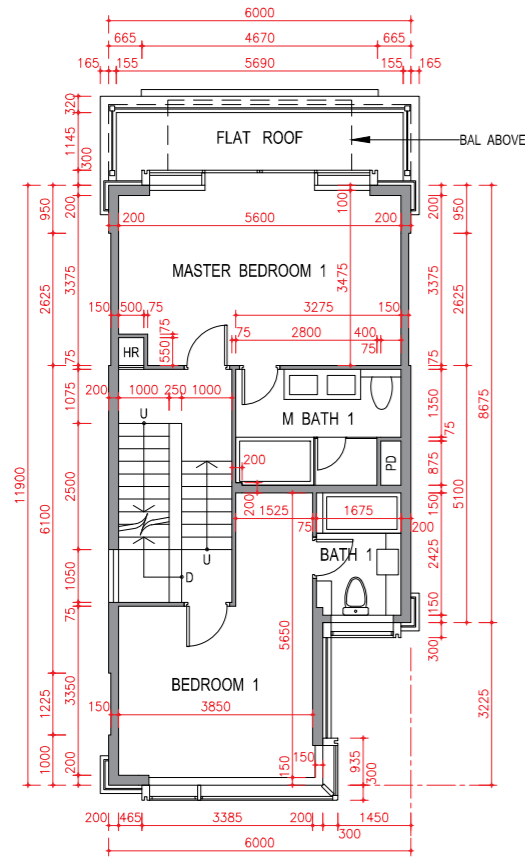
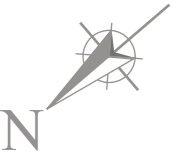

1/F Plan
一樓平面圖

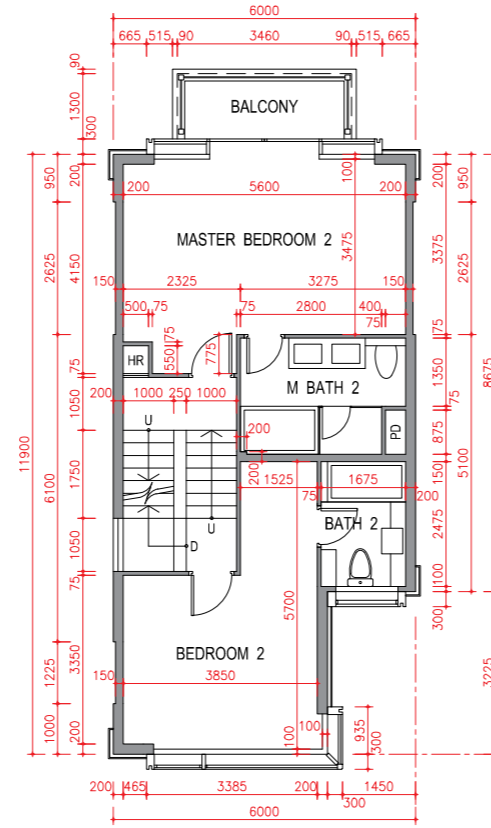

2/F Plan
二樓平面圖

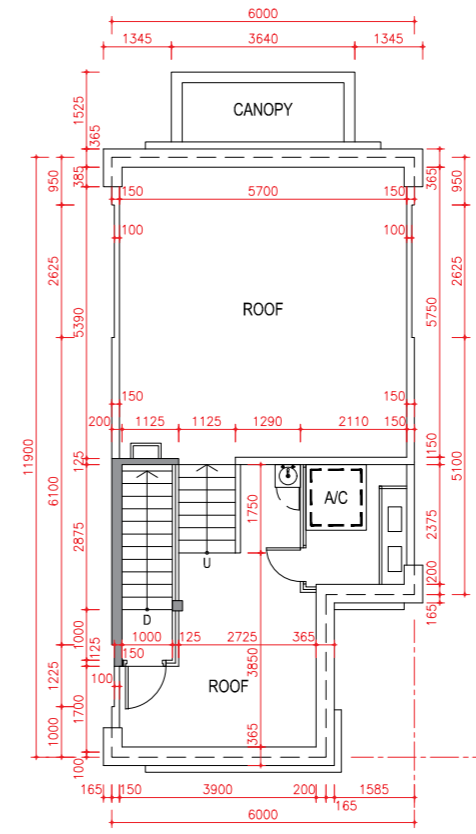

Roof Plan
天台平面圖

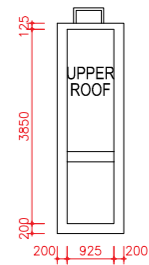

Upper Roof Plan
上層天台平面圖



83E Tan Kwai Tsuen Road, Casa Regalia 富豪·悅庭丹桂村路 83E 號

Floor 樓層	The thickness of the floor slabs (excluding plaster) of each House (mm) 每座洋房的樓板(不包括灰泥)的厚度(毫米)	The floor-to-floor height of each House (mm) 每座洋房的層與層之間的高度(毫米)
Basement 地下樓層	-	3650
G/F 地下	150, 175	2950 / 4150
1/F 一樓	150	3400
2/F 二樓	150	3400
Roof 天台	150	2825

The internal areas of the residential properties on the upper floors will generally be slightly larger than those on the lower floors because of the reducing thickness of the structural walls on the upper floors.

因住宅物業的較高樓層的結構牆的厚度遞減，較高樓層的內部面積，一般比較低樓層的內部面積稍大。

Notes:

- The dimensions of floor plans are all structural dimensions in millimeter.
- There may be architectural features and/or exposed pipes on external walls of DOMUS/Houses. For details, please refer to the latest approved building plans.
- Common pipes exposed and/or enclosed in cladding are located at/adjacent to flat roof and/or external wall of DOMUS/Houses. For details, please refer to the latest approved building plans.
- There are ceiling bulkheads and/or sunken slab of the above Flats/Houses at living/dining room, bedrooms, corridors and/or kitchen of the above Flats/Houses for the air-conditioning system and/or mechanical and electrical services.
- Please refer to page 20 of this sales brochure for legend of the terms and abbreviations shown in the floor plan above.
- Under Special Condition No. (9)(g) of the Land Grant, the total number of residential units erected or to be erected on the Lot shall not be less than 170.
- According to Clause 55 of the Third Schedule to the DMC, no Owner shall demolish or alter the partition walls separating two Residential Units (as defined in the DMC) or a common wall dividing the land upon which two Houses (as defined in the DMC) are constructed or the floor slabs or roof slabs between two Residential Units which will result in such Residential Units being internally linked to and accessible from each other, except with the prior written consent of the Director of Lands or other Government authority in place of him from time to time.

備註：

- 平面圖所列之尺寸數字為以毫米標示之建築尺寸。
- 尚築及洋房外牆設有建築裝飾及/或外露喉管。詳細資料請參考最新批准之建築圖則。
- 尚築及洋房的平台及/或外牆設有外露及/或外牆裝飾板內藏之公用喉管。詳細資料請參考最新批准的建築圖則。
- 大樓及洋房客/飯廳、睡房、走廊及/或廚房有假天花及/或有跌級樓板以內藏冷氣系統及/或機電設備。
- 以上平面圖中顯示之名詞及簡稱請參閱本售樓書第20頁。
- 批地文件特別條款第(9)(g)條規定，在該地段已建或擬建的住宅單位不得少於170個。
- 根據公契附表3第55條，除非已事先獲得地政總署署長或取代地政總署署長的其他政府機構不時作出的同意，否則任何業主不得拆卸或變更分隔兩個住宅單位(定義見公契)的間隔牆、分隔兩間洋房(定義見公契)土地的公用牆、或兩個住宅單位之間的水泥板或屋頂板以致使該等住宅單位能夠在內部連接及互通。

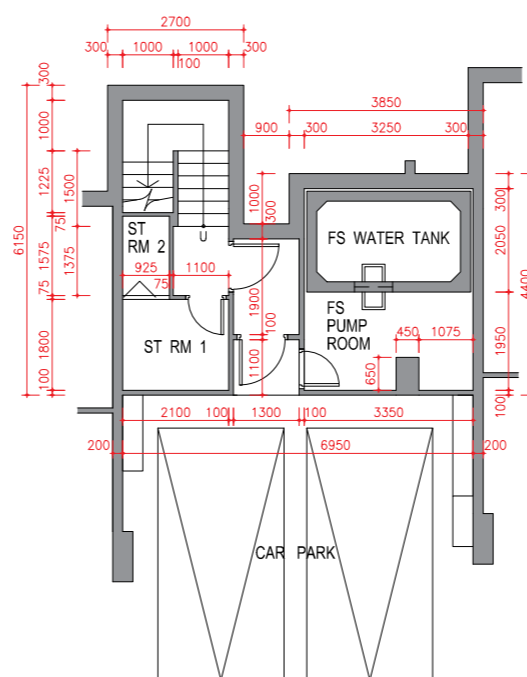

Basement Plan
地庫平面圖

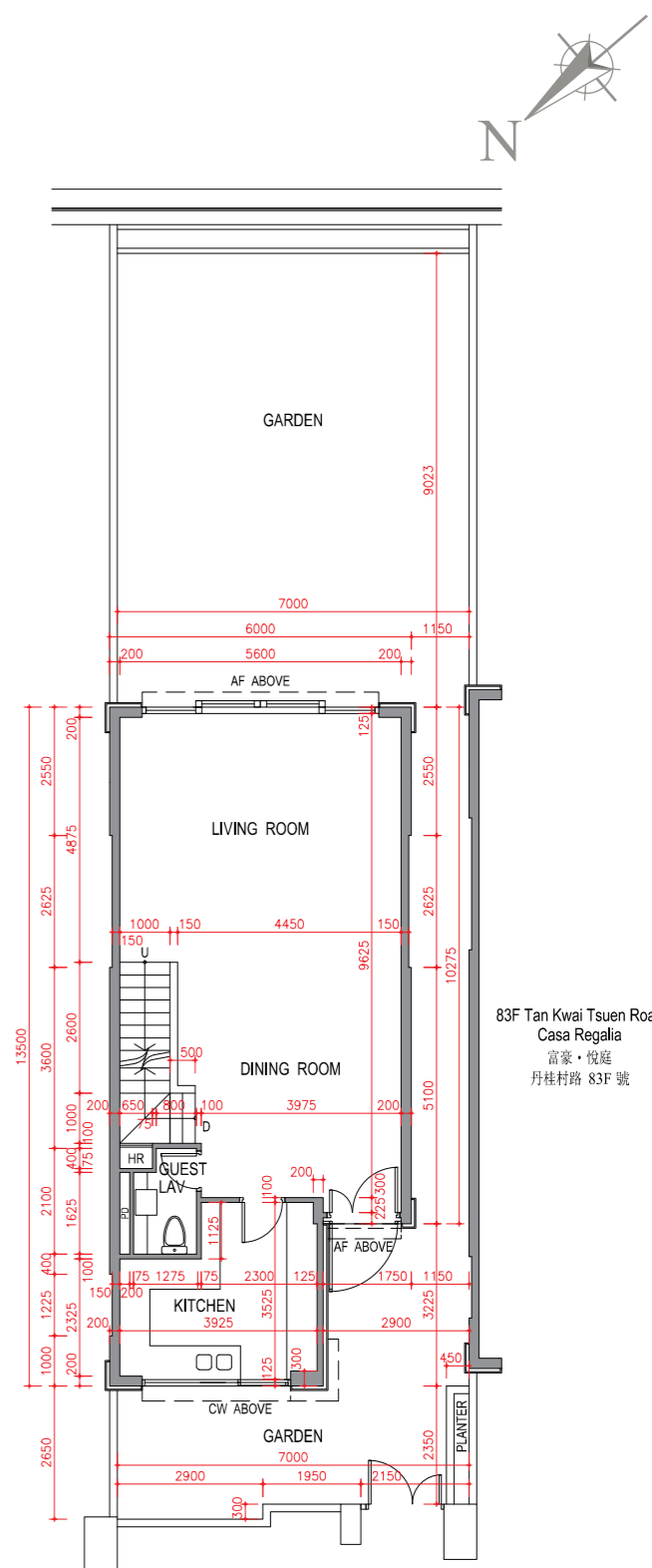

G/F Plan
地面層平面圖

Scale: 0M / 米 5M / 米
比例:

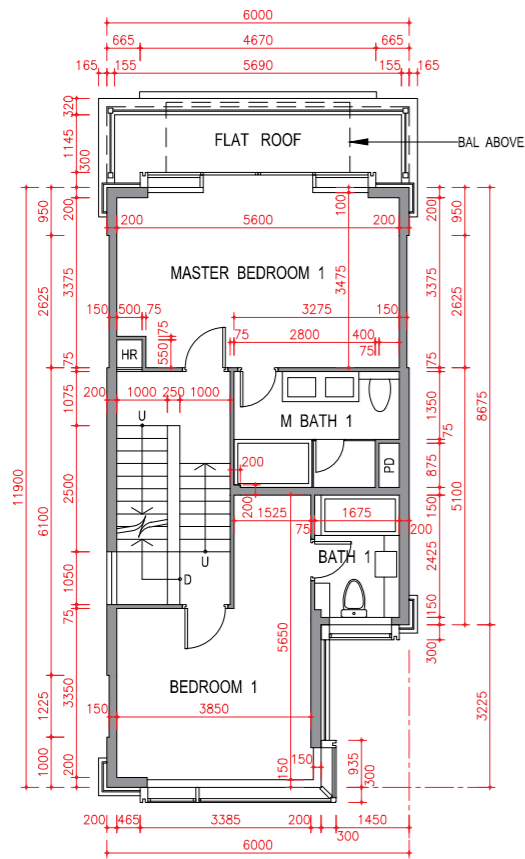
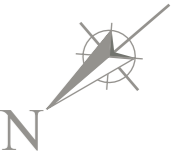

1/F Plan
一樓平面圖

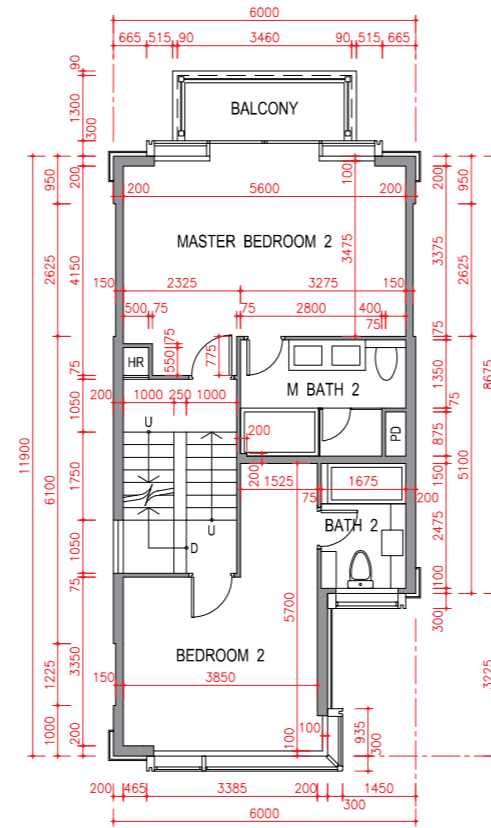

2/F Plan
二樓平面圖

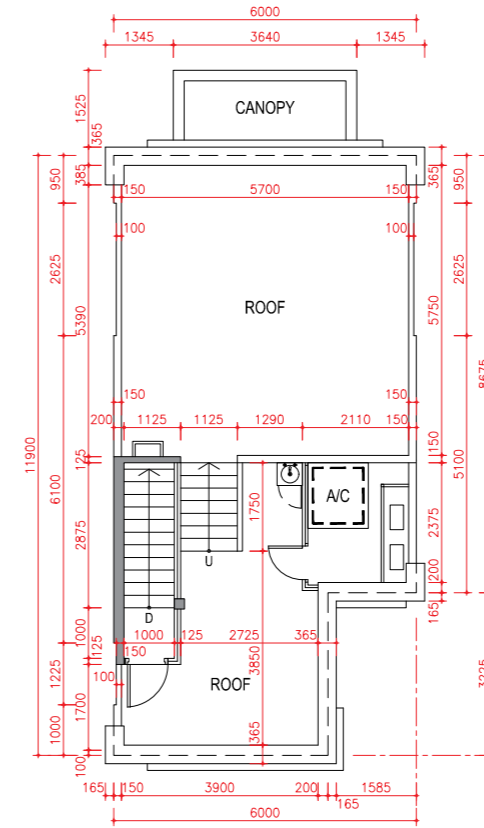

Roof Plan
天台平面圖

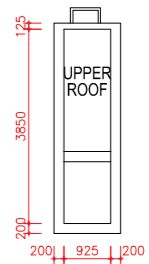

Upper Roof Plan
上層天台平面圖

0M / 米 5M / 米
Scale:
比例:

83F Tan Kwai Tsuen Road, Casa Regalia 富豪·悅庭丹桂村路 83F 號

Floor 樓層	The thickness of the floor slabs (excluding plaster) of each House (mm) 每座洋房的樓板(不包括灰泥)的厚度(毫米)	The floor-to-floor height of each House (mm) 每座洋房的層與層之間的高度(毫米)
Basement 地下樓層	-	3650
G/F 地下	150, 175	2950 / 4150
1/F 一樓	150	3400
2/F 二樓	150	3400
Roof 天台	150	2825

The internal areas of the residential properties on the upper floors will generally be slightly larger than those on the lower floors because of the reducing thickness of the structural walls on the upper floors.

因住宅物業的較高樓層的結構牆的厚度遞減，較高樓層的內部面積，一般比較低樓層的內部面積稍大。

Notes:

- The dimensions of floor plans are all structural dimensions in millimeter.
- There may be architectural features and/or exposed pipes on external walls of DOMUS/Houses. For details, please refer to the latest approved building plans.
- Common pipes exposed and/or enclosed in cladding are located at/adjacent to flat roof and/or external wall of DOMUS/Houses. For details, please refer to the latest approved building plans.
- There are ceiling bulkheads and/or sunken slab of the above Flats/Houses at living/dining room, bedrooms, corridors and/or kitchen of the above Flats/Houses for the air-conditioning system and/or mechanical and electrical services.
- Please refer to page 20 of this sales brochure for legend of the terms and abbreviations shown in the floor plan above.
- Under Special Condition No. (9)(g) of the Land Grant, the total number of residential units erected or to be erected on the Lot shall not be less than 170.
- According to Clause 55 of the Third Schedule to the DMC, no Owner shall demolish or alter the partition walls separating two Residential Units (as defined in the DMC) or a common wall dividing the land upon which two Houses (as defined in the DMC) are constructed or the floor slabs or roof slabs between two Residential Units which will result in such Residential Units being internally linked to and accessible from each other, except with the prior written consent of the Director of Lands or other Government authority in place of him from time to time.

備註：

- 平面圖所列之尺寸數字為以毫米標示之建築尺寸。
- 尚築及洋房外牆設有建築裝飾及/或外露喉管。詳細資料請參考最新批准之建築圖則。
- 尚築及洋房的平台及/或外牆設有外露及/或外牆裝飾板內藏之公用喉管。詳細資料請參考最新批准的建築圖則。
- 大樓及洋房客/飯廳、睡房、走廊及/或廚房有假天花及/或有跌級樓板以內藏冷氣系統及/或機電設備。
- 以上平面圖中顯示之名詞及簡稱請參閱本售樓書第20頁。
- 批地文件特別條款第(9)(g)條規定，在該地段已建或擬建的住宅單位不得少於170個。
- 根據公契附表3第55條，除非已事先獲得地政總署署長或取代地政總署署長的其他政府機構不時作出的同意，否則任何業主不得拆卸或變更分隔兩個住宅單位(定義見公契)的間隔牆、分隔兩間洋房(定義見公契)土地的公用牆、或兩個住宅單位之間的水泥板或屋頂板以致使該等住宅單位能夠在內部連接及互通。

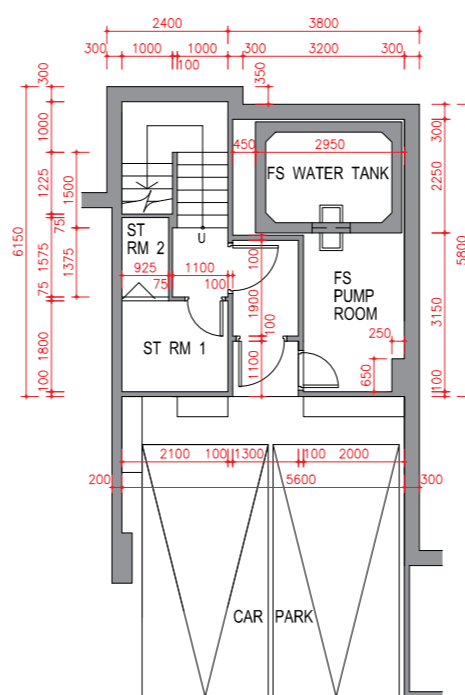

Basement Plan
地庫平面圖

83E Tan Kwai Tsuen Road
Casa Regalia
富豪·悅庭
丹桂村路 83E 號

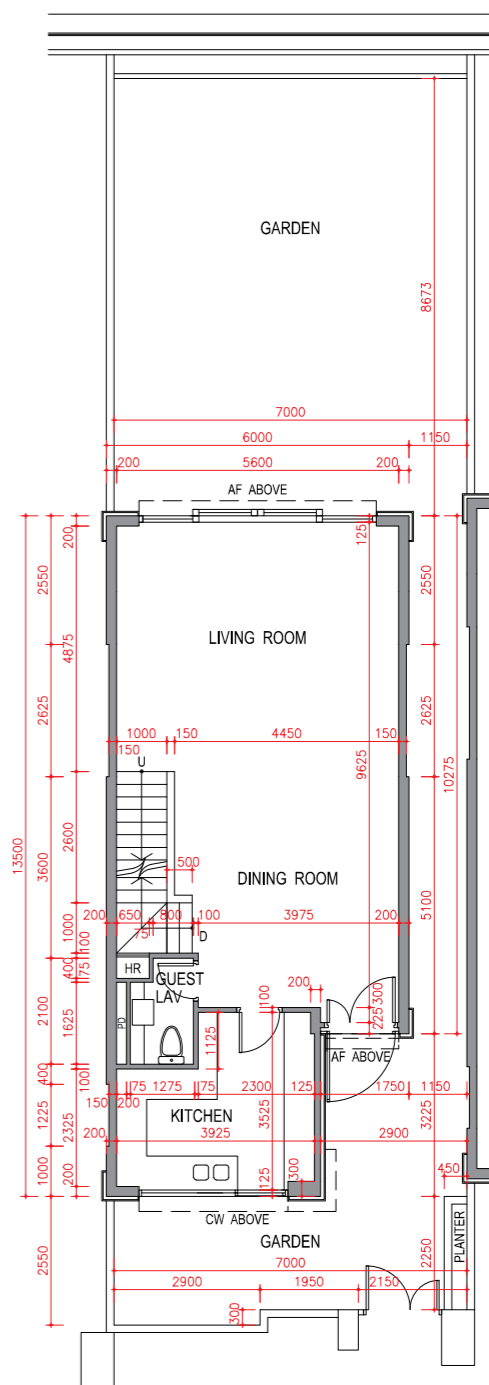

G/F Plan
地面層平面圖

83G Tan Kwai Tsuen Road
Casa Regalia
富豪·悅庭
丹桂村路 83G 號

0M / 米
Scale:
比例: 5M / 米

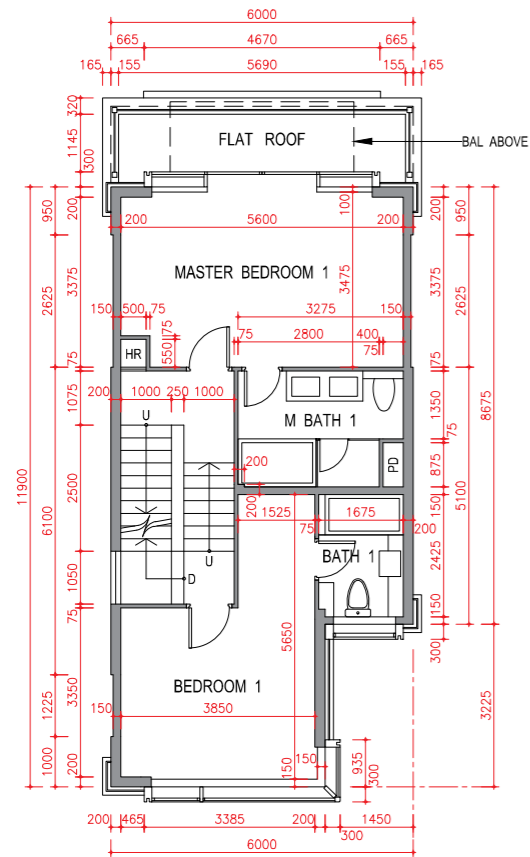
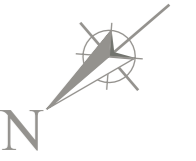

1/F Plan
一樓平面圖

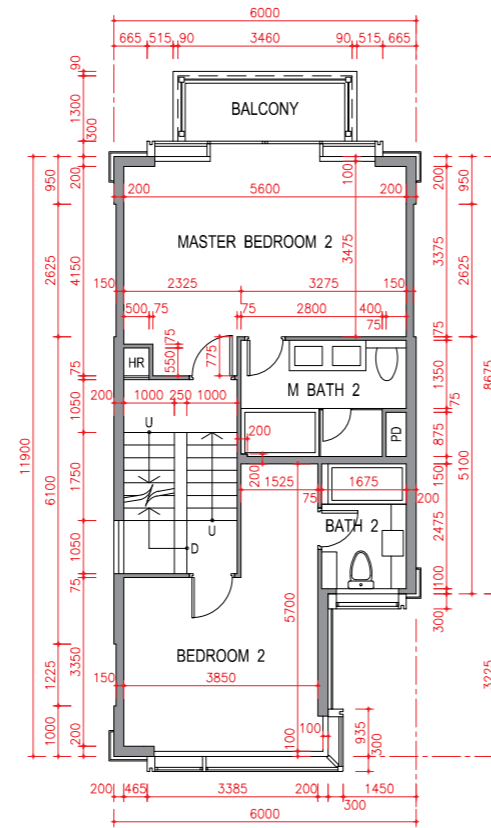

2/F Plan
二樓平面圖

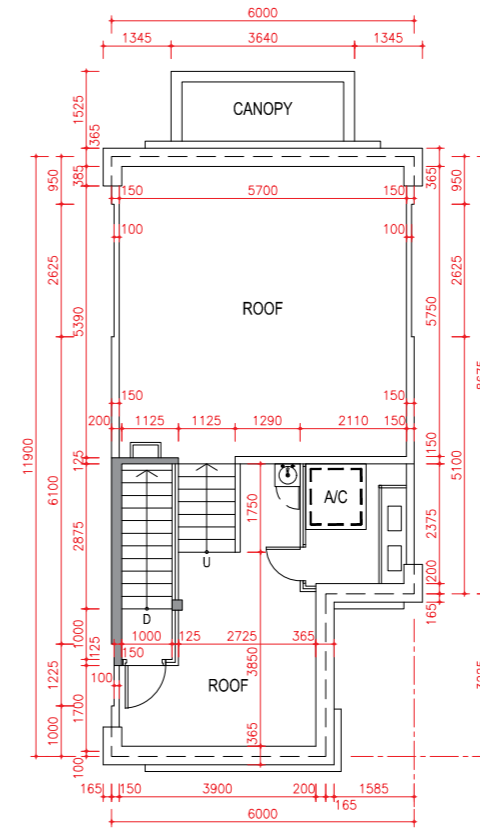

Roof Plan
天台平面圖

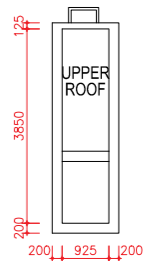

Upper Roof Plan
上層天台平面圖

0M / 米 5M / 米
Scale:
比例:

83G Tan Kwai Tsuen Road, Casa Regalia 富豪·悦庭丹桂村路 83G 號



Floor 樓層	The thickness of the floor slabs (excluding plaster) of each House (mm) 每座洋房的樓板(不包括灰泥)的厚度(毫米)	The floor-to-floor height of each House (mm) 每座洋房的層與層之間的高度(毫米)
Basement 地下樓層	-	3650
G/F 地下	150, 175	2950/4150
1/F 一樓	150	3400
2/F 二樓	150	3400
Roof 天台	150	2825

The internal areas of the residential properties on the upper floors will generally be slightly larger than those on the lower floors because of the reducing thickness of the structural walls on the upper floors.

因住宅物業的較高樓層的結構牆的厚度遞減，較高樓層的內部面積，一般比較低樓層的內部面積稍大。

Notes:

- The dimensions of floor plans are all structural dimensions in millimeter.
- There may be architectural features and/or exposed pipes on external walls of DOMUS/Houses. For details, please refer to the latest approved building plans.
- Common pipes exposed and/or enclosed in cladding are located at/adjacent to flat roof and/or external wall of DOMUS/Houses. For details, please refer to the latest approved building plans.
- There are ceiling bulkheads and/or sunken slab of the above Flats/Houses at living/dining room, bedrooms, corridors and/or kitchen of the above Flats/Houses for the air-conditioning system and/or mechanical and electrical services.
- Please refer to page 20 of this sales brochure for legend of the terms and abbreviations shown in the floor plan above.
- Under Special Condition No. (9)(g) of the Land Grant, the total number of residential units erected or to be erected on the Lot shall not be less than 170.
- According to Clause 55 of the Third Schedule to the DMC, no Owner shall demolish or alter the partition walls separating two Residential Units (as defined in the DMC) or a common wall dividing the land upon which two Houses (as defined in the DMC) are constructed or the floor slabs or roof slabs between two Residential Units which will result in such Residential Units being internally linked to and accessible from each other, except with the prior written consent of the Director of Lands or other Government authority in place of him from time to time.

備註：

- 平面圖所列之尺寸數字為以毫米標示之建築尺寸。
- 尚築及洋房外牆設有建築裝飾及/或外露喉管。詳細資料請參考最新批准之建築圖則。
- 尚築及洋房的平台及/或外牆設有外露及/或外牆裝飾板內藏之公用喉管。詳細資料請參考最新批准的建築圖則。
- 大樓及洋房客/飯廳、睡房、走廊及/或廚房有假天花及/或有跌級樓板以內藏冷氣系統及/或機電設備。
- 以上平面圖中顯示之名詞及簡稱請參閱本售樓書第20頁。
- 批地文件特別條款第(9)(g)條規定，在該地段已建或擬建的住宅單位不得少於170個。
- 根據公契附表3第55條，除非已事先獲得地政總署署長或取代地政總署署長的其他政府機構不時作出的同意，否則任何業主不得拆卸或變更分隔兩個住宅單位(定義見公契)的間隔牆、分隔兩間洋房(定義見公契)土地的公用牆、或兩個住宅單位之間的水泥板或屋頂板以致使該等住宅單位能夠在內部連接及互通。

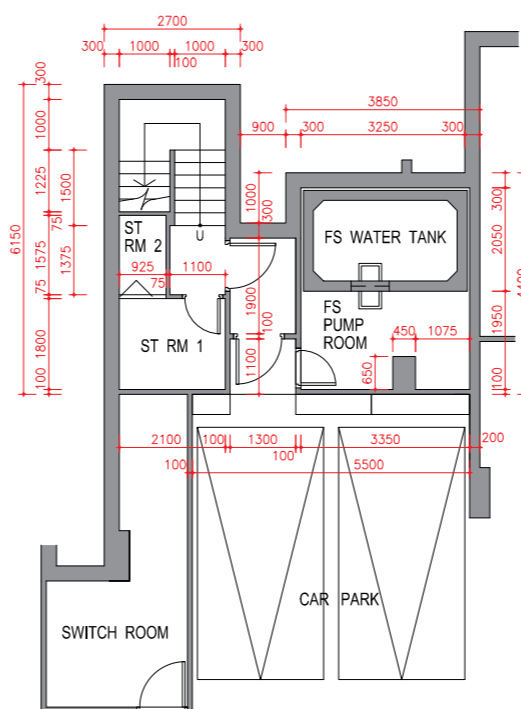

Basement Plan
地庫平面圖

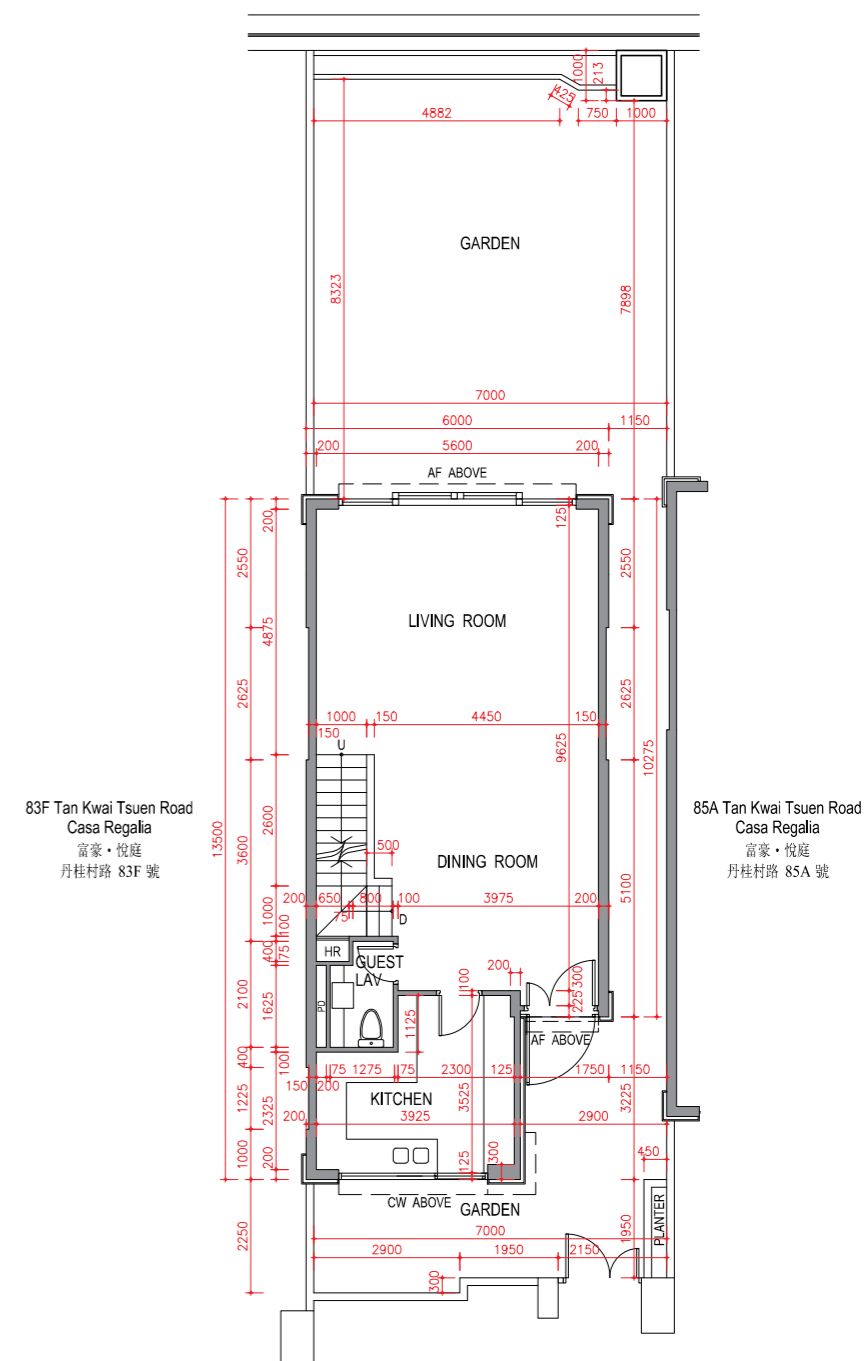

G/F Plan
地面層平面圖

Scale: 0M / 米 5M / 米
比例:

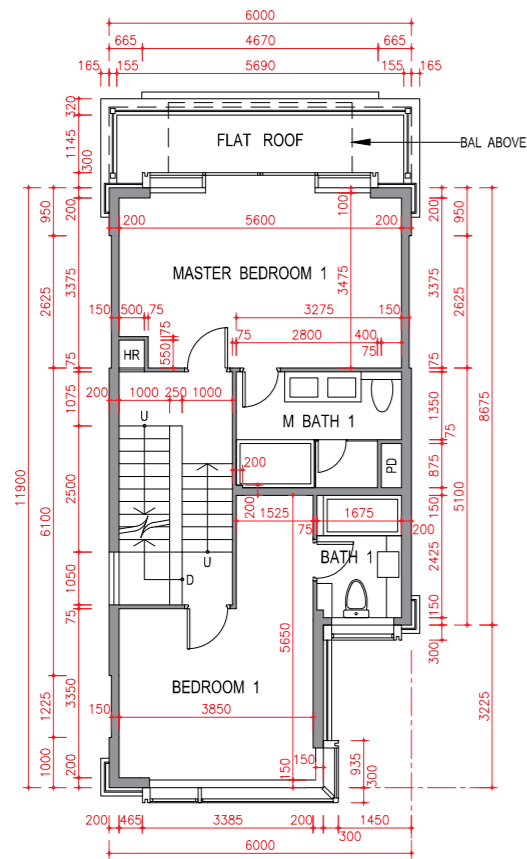
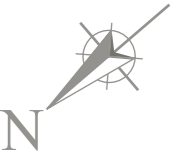

1/F Plan
一樓平面圖

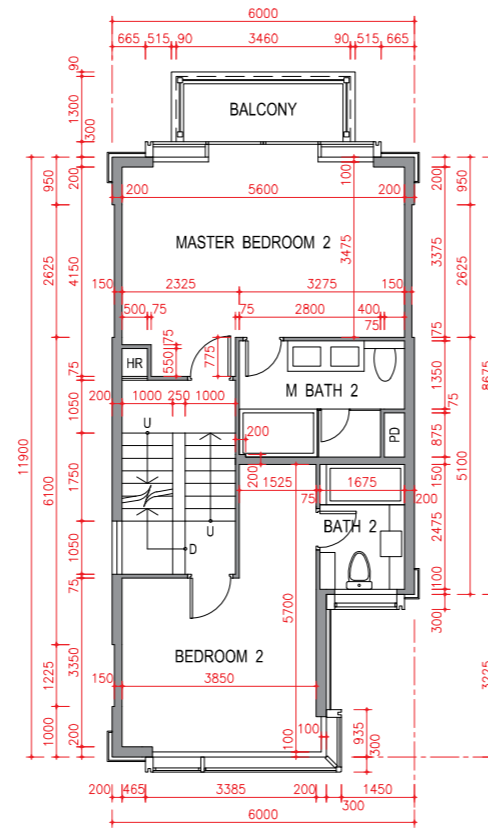

2/F Plan
二樓平面圖

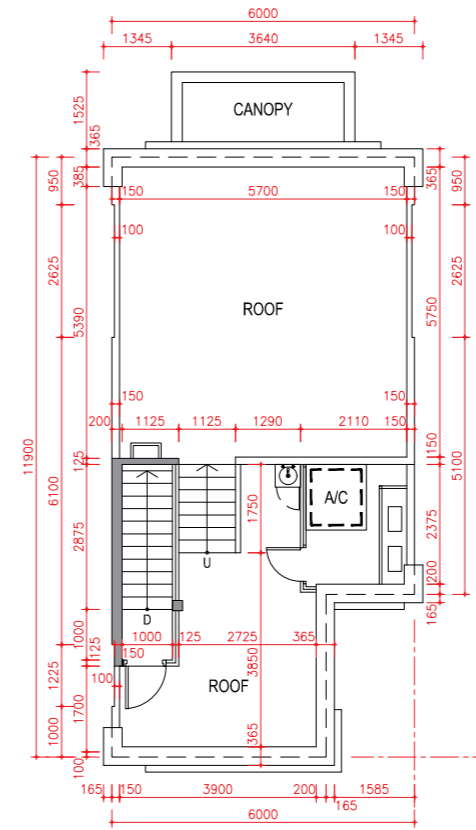

Roof Plan
天台平面圖

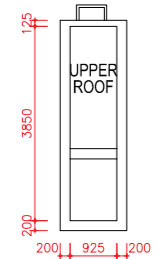

Upper Roof Plan
上層天台平面圖



85A Tan Kwai Tsuen Road, Casa Regalia 富豪·悦庭丹桂村路 85A 號



Floor 樓層	The thickness of the floor slabs (excluding plaster) of each House (mm) 每座洋房的樓板(不包括灰泥)的厚度(毫米)	The floor-to-floor height of each House (mm) 每座洋房的層與層之間的高度(毫米)
Basement 地下樓層	-	3650
G/F 地下	150, 175	4150
1/F 一樓	150, 175	3400
2/F 二樓	150	3400
Roof 天台	150	2825

The internal areas of the residential properties on the upper floors will generally be slightly larger than those on the lower floors because of the reducing thickness of the structural walls on the upper floors.

因住宅物業的較高樓層的結構牆的厚度遞減，較高樓層的內部面積，一般比較低樓層的內部面積稍大。

Notes:

- The dimensions of floor plans are all structural dimensions in millimeter.
- There may be architectural features and/or exposed pipes on external walls of DOMUS/Houses. For details, please refer to the latest approved building plans.
- Common pipes exposed and/or enclosed in cladding are located at/adjacent to flat roof and/or external wall of DOMUS/Houses. For details, please refer to the latest approved building plans.
- There are ceiling bulkheads and/or sunken slab of the above Flats/Houses at living/dining room, bedrooms, corridors and/or kitchen of the above Flats/Houses for the air-conditioning system and/or mechanical and electrical services.
- Please refer to page 20 of this sales brochure for legend of the terms and abbreviations shown in the floor plan above.
- Under Special Condition No. (9)(g) of the Land Grant, the total number of residential units erected or to be erected on the Lot shall not be less than 170.
- According to Clause 55 of the Third Schedule to the DMC, no Owner shall demolish or alter the partition walls separating two Residential Units (as defined in the DMC) or a common wall dividing the land upon which two Houses (as defined in the DMC) are constructed or the floor slabs or roof slabs between two Residential Units which will result in such Residential Units being internally linked to and accessible from each other, except with the prior written consent of the Director of Lands or other Government authority in place of him from time to time.

備註：

- 平面圖所列之尺寸數字為以毫米標示之建築尺寸。
- 尚築及洋房外牆設有建築裝飾及/或外露喉管。詳細資料請參考最新批准之建築圖則。
- 尚築及洋房的平台及/或外牆設有外露及/或外牆裝飾板內藏之公用喉管。詳細資料請參考最新批准的建築圖則。
- 大樓及洋房客/飯廳、睡房、走廊及/或廚房有假天花及/或有跌級樓板以內藏冷氣系統及/或機電設備。
- 以上平面圖中顯示之名詞及簡稱請參閱本售樓書第20頁。
- 批地文件特別條款第(9)(g)條規定，在該地段已建或擬建的住宅單位不得少於170個。
- 根據公契附表3第55條，除非已事先獲得地政總署署長或取代地政總署署長的其他政府機構不時作出的同意，否則任何業主不得拆卸或變更分隔兩個住宅單位(定義見公契)的間隔牆、分隔兩間洋房(定義見公契)土地的公用牆、或兩個住宅單位之間的水泥板或屋頂板以致使該等住宅單位能夠在內部連接及互通。

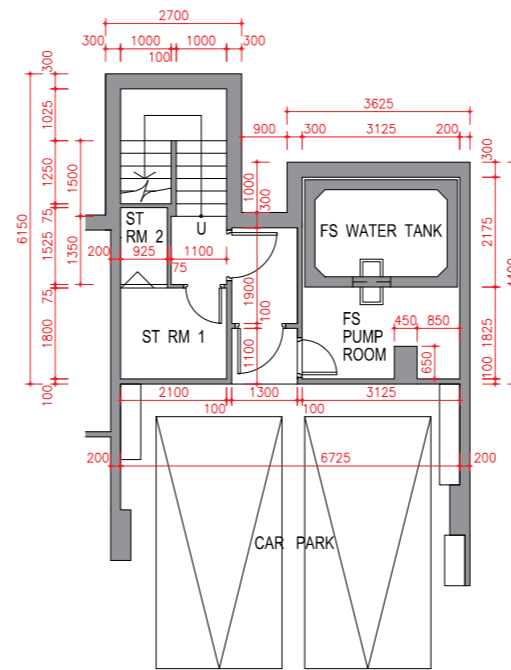

Basement Plan
地庫平面圖

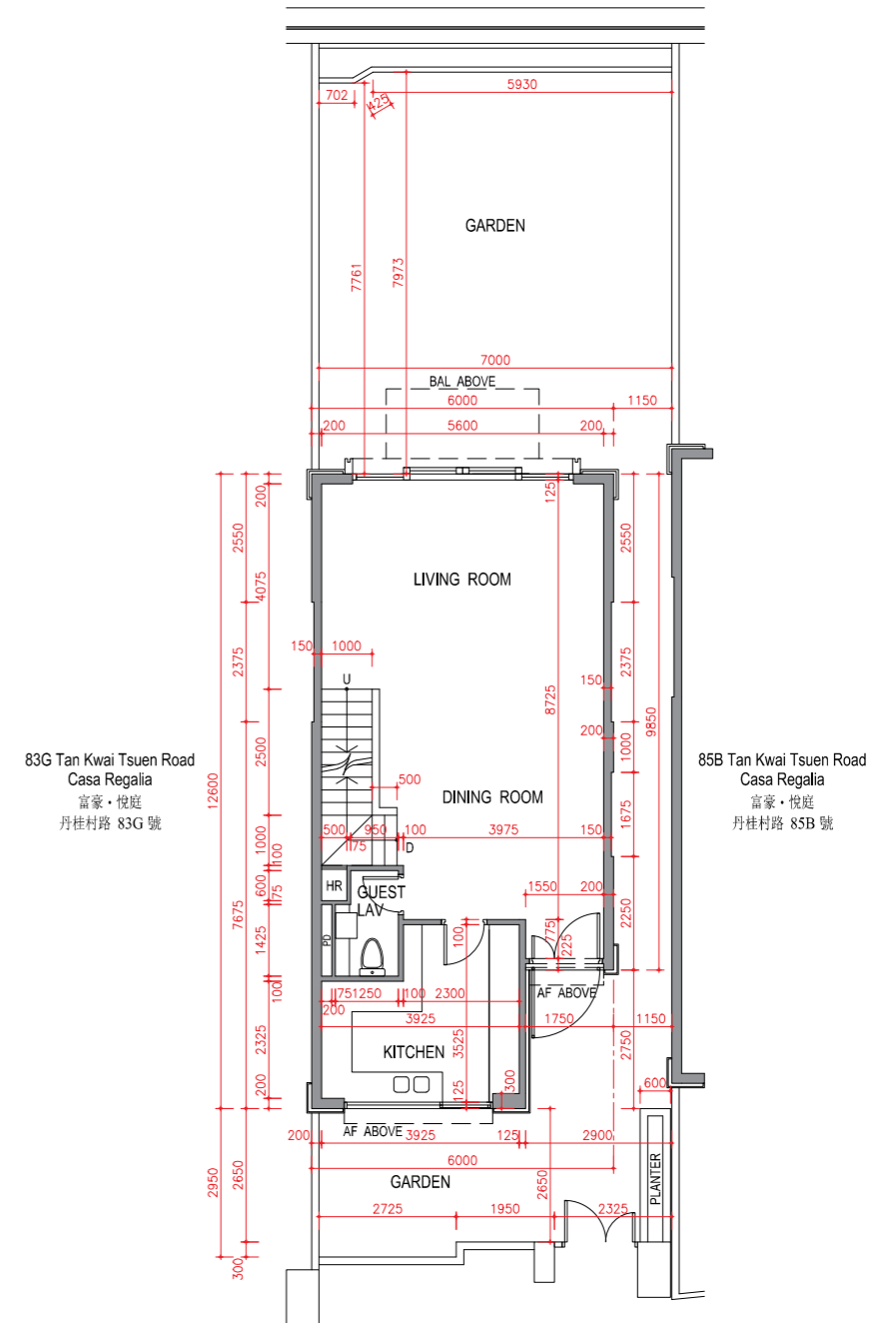

G/F Plan
地面層平面圖

0M / 米
Scale:
比例: 5M / 米

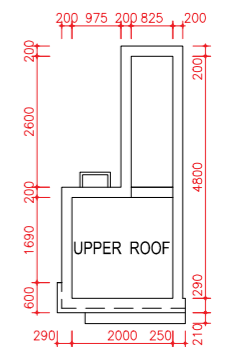
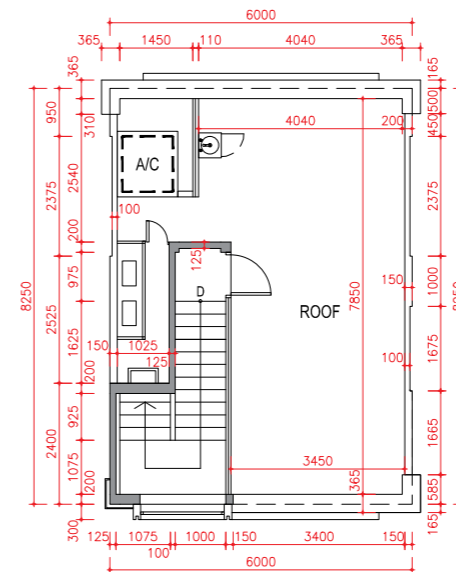
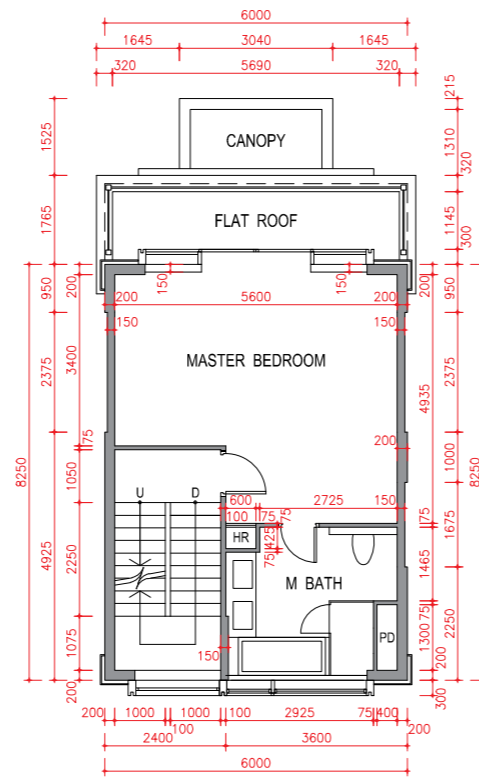
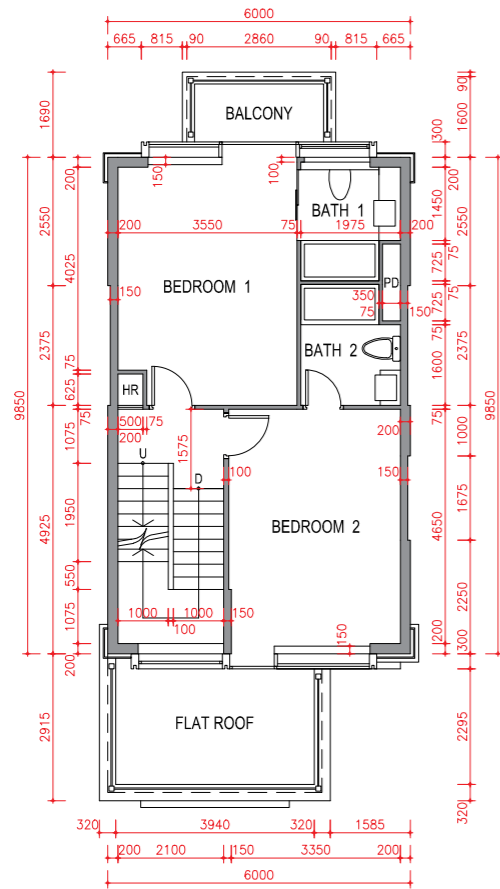
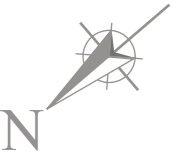

0M / 米 5M / 米
Scale:
比例:

85B Tan Kwai Tsuen Road, Casa Regalia 富豪·悅庭丹桂村路 85B 號

Floor 樓層	The thickness of the floor slabs (excluding plaster) of each House (mm) 每座洋房的樓板(不包括灰泥)的厚度(毫米)	The floor-to-floor height of each House (mm) 每座洋房的層與層之間的高度(毫米)
Basement 地下樓層	-	3650
G/F 地下	150, 175	4150
1/F 一樓	150, 175	3400
2/F 二樓	150	3400
Roof 天台	150	2825

The internal areas of the residential properties on the upper floors will generally be slightly larger than those on the lower floors because of the reducing thickness of the structural walls on the upper floors.

因住宅物業的較高樓層的結構牆的厚度遞減，較高樓層的內部面積，一般比較低樓層的內部面積稍大。

Notes:

- The dimensions of floor plans are all structural dimensions in millimeter.
- There may be architectural features and/or exposed pipes on external walls of DOMUS/Houses. For details, please refer to the latest approved building plans.
- Common pipes exposed and/or enclosed in cladding are located at/adjacent to flat roof and/or external wall of DOMUS/Houses. For details, please refer to the latest approved building plans.
- There are ceiling bulkheads and/or sunken slab of the above Flats/Houses at living/dining room, bedrooms, corridors and/or kitchen of the above Flats/Houses for the air-conditioning system and/or mechanical and electrical services.
- Please refer to page 20 of this sales brochure for legend of the terms and abbreviations shown in the floor plan above.
- Under Special Condition No. (9)(g) of the Land Grant, the total number of residential units erected or to be erected on the Lot shall not be less than 170.
- According to Clause 55 of the Third Schedule to the DMC, no Owner shall demolish or alter the partition walls separating two Residential Units (as defined in the DMC) or a common wall dividing the land upon which two Houses (as defined in the DMC) are constructed or the floor slabs or roof slabs between two Residential Units which will result in such Residential Units being internally linked to and accessible from each other, except with the prior written consent of the Director of Lands or other Government authority in place of him from time to time.

備註：

- 平面圖所列之尺寸數字為以毫米標示之建築尺寸。
- 尚築及洋房外牆設有建築裝飾及/或外露喉管。詳細資料請參考最新批准之建築圖則。
- 尚築及洋房的平台及/或外牆設有外露及/或外牆裝飾板內藏之公用喉管。詳細資料請參考最新批准的建築圖則。
- 大樓及洋房客/飯廳、睡房、走廊及/或廚房有假天花及/或有跌級樓板以內藏冷氣系統及/或機電設備。
- 以上平面圖中顯示之名詞及簡稱請參閱本售樓書第20頁。
- 批地文件特別條款第(9)(g)條規定，在該地段已建或擬建的住宅單位不得少於170個。
- 根據公契附表3第55條，除非已事先獲得地政總署署長或取代地政總署署長的其他政府機構不時的同意，否則任何業主不得拆卸或變更分隔兩個住宅單位(定義見公契)的間隔牆、分隔兩間洋房(定義見公契)土地的公用牆、或兩個住宅單位之間的水泥板或屋頂板以致使該等住宅單位能夠在內部連接及互通。

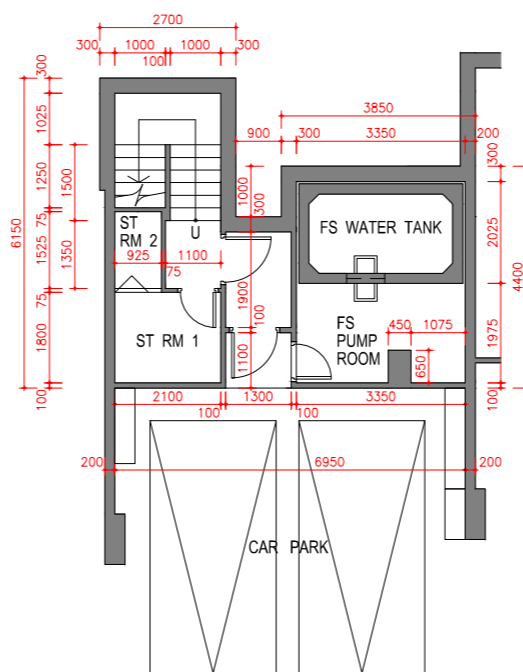

Basement Plan
地庫平面圖

85A Tan Kwai Tsuen Road
Casa Regalia
富豪·悅庭
丹桂村路 85A 號

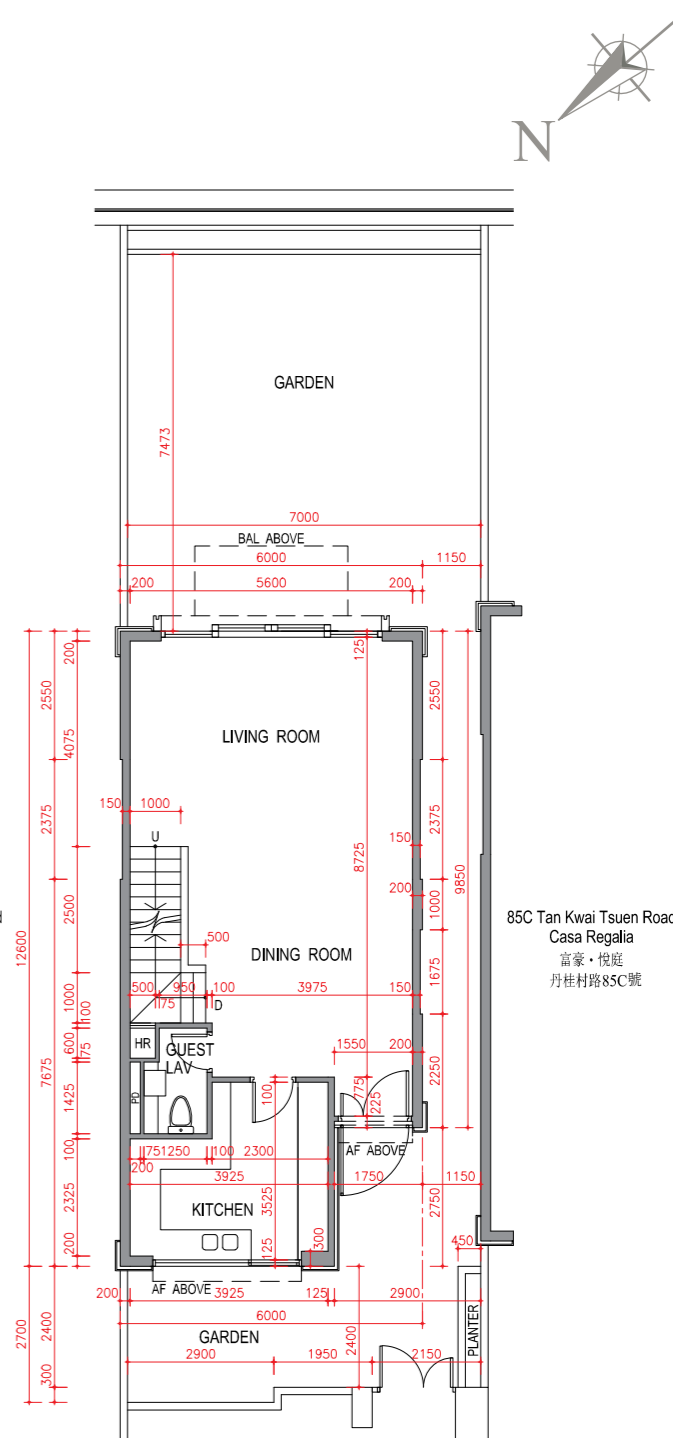

G/F Plan
地面層平面圖



0M / 米 5M / 米
Scale:
比例:

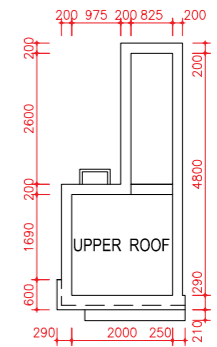
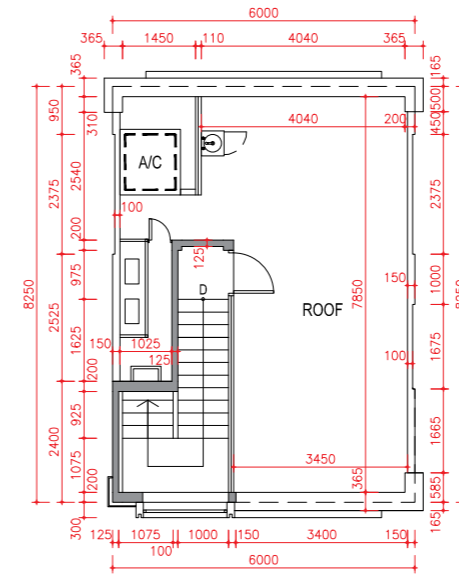
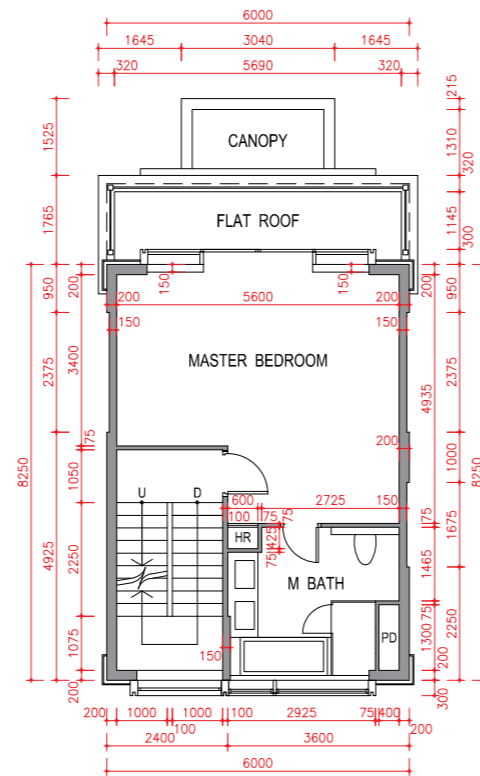
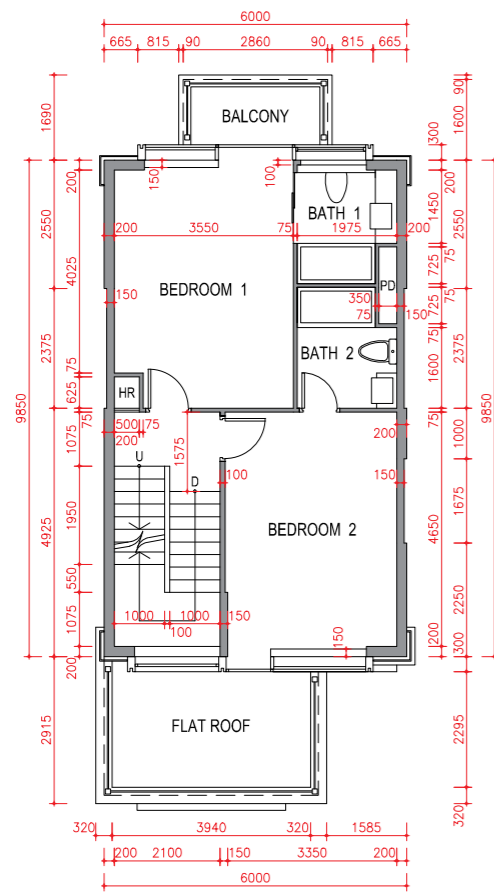
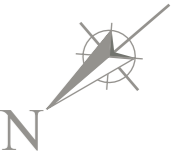

1/F Plan
一樓平面圖

2/F Plan
二樓平面圖

Roof Plan
天台平面圖

Upper Roof Plan
上層天台平面圖

0M / 米 5M / 米
Scale:
比例:

85C Tan Kwai Tsuen Road, Casa Regalia 富豪·悅庭丹桂村路 85C 號



Floor 樓層	The thickness of the floor slabs (excluding plaster) of each House (mm) 每座洋房的樓板(不包括灰泥)的厚度(毫米)	The floor-to-floor height of each House (mm) 每座洋房的層與層之間的高度(毫米)
Basement 地下樓層	-	3650
G/F 地下	150, 175	4150
1/F 一樓	150, 175	3400
2/F 二樓	150	3400
Roof 天台	150	2825

The internal areas of the residential properties on the upper floors will generally be slightly larger than those on the lower floors because of the reducing thickness of the structural walls on the upper floors.

因住宅物業的較高樓層的結構牆的厚度遞減，較高樓層的內部面積，一般比較低樓層的內部面積稍大。

Notes:

- The dimensions of floor plans are all structural dimensions in millimeter.
- There may be architectural features and/or exposed pipes on external walls of DOMUS/Houses. For details, please refer to the latest approved building plans.
- Common pipes exposed and/or enclosed in cladding are located at/adjacent to flat roof and/or external wall of DOMUS/Houses. For details, please refer to the latest approved building plans.
- There are ceiling bulkheads and/or sunken slab of the above Flats/Houses at living/dining room, bedrooms, corridors and/or kitchen of the above Flats/Houses for the air-conditioning system and/or mechanical and electrical services.
- Please refer to page 20 of this sales brochure for legend of the terms and abbreviations shown in the floor plan above.
- Under Special Condition No. (9)(g) of the Land Grant, the total number of residential units erected or to be erected on the Lot shall not be less than 170.
- According to Clause 55 of the Third Schedule to the DMC, no Owner shall demolish or alter the partition walls separating two Residential Units (as defined in the DMC) or a common wall dividing the land upon which two Houses (as defined in the DMC) are constructed or the floor slabs or roof slabs between two Residential Units which will result in such Residential Units being internally linked to and accessible from each other, except with the prior written consent of the Director of Lands or other Government authority in place of him from time to time.

備註：

- 平面圖所列之尺寸數字為以毫米標示之建築尺寸。
- 尚築及洋房外牆設有建築裝飾及/或外露喉管。詳細資料請參考最新批准之建築圖則。
- 尚築及洋房的平台及/或外牆設有外露及/或外牆裝飾板內藏之公用喉管。詳細資料請參考最新批准的建築圖則。
- 大樓及洋房客/飯廳、睡房、走廊及/或廚房有假天花及/或有跌級樓板以內藏冷氣系統及/或機電設備。
- 以上平面圖中顯示之名詞及簡稱請參閱本售樓書第20頁。
- 批地文件特別條款第(9)(g)條規定，在該地段已建或擬建的住宅單位不得少於170個。
- 根據公契附表3第55條，除非已事先獲得地政總署署長或取代地政總署署長的其他政府機構不時作出的同意，否則任何業主不得拆卸或變更分隔兩個住宅單位(定義見公契)的間隔牆、分隔兩間洋房(定義見公契)土地的公用牆、或兩個住宅單位之間的水泥板或屋頂板以致使該等住宅單位能夠在內部連接及互通。

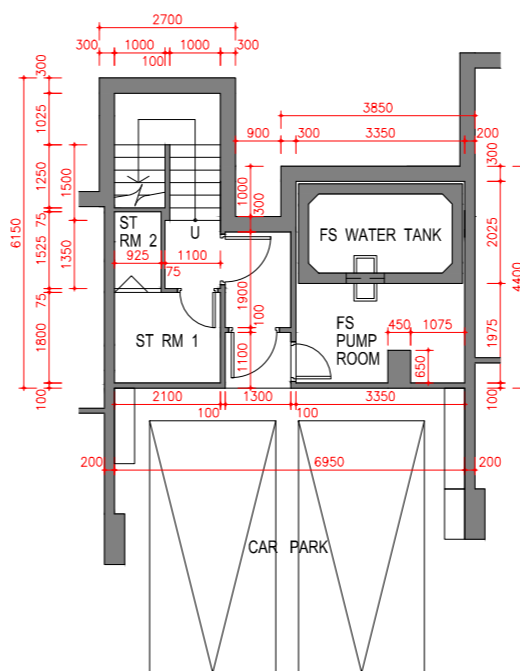

Basement Plan
地庫平面圖

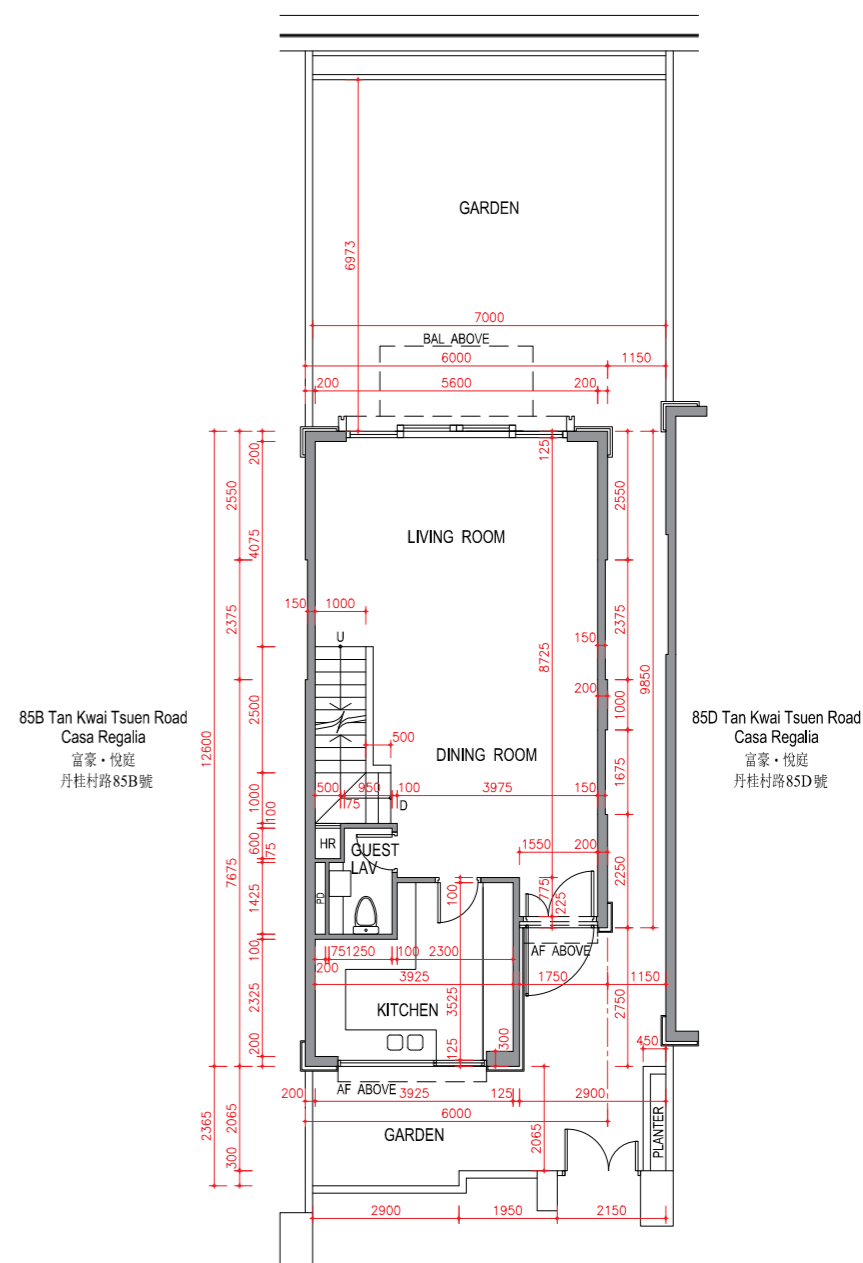

G/F Plan
地面層平面圖

Scale: 0M / 米 5M / 米
比例:

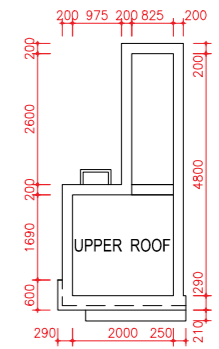
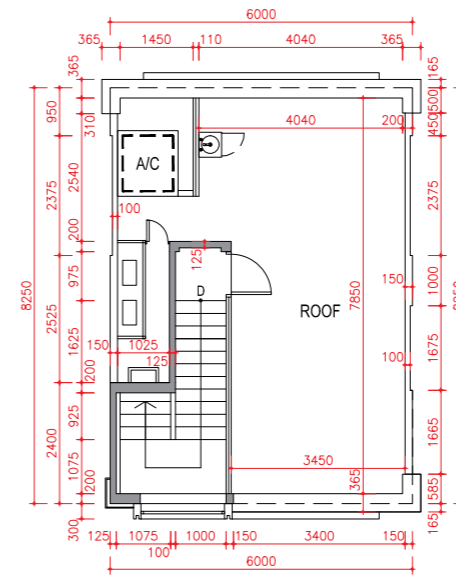
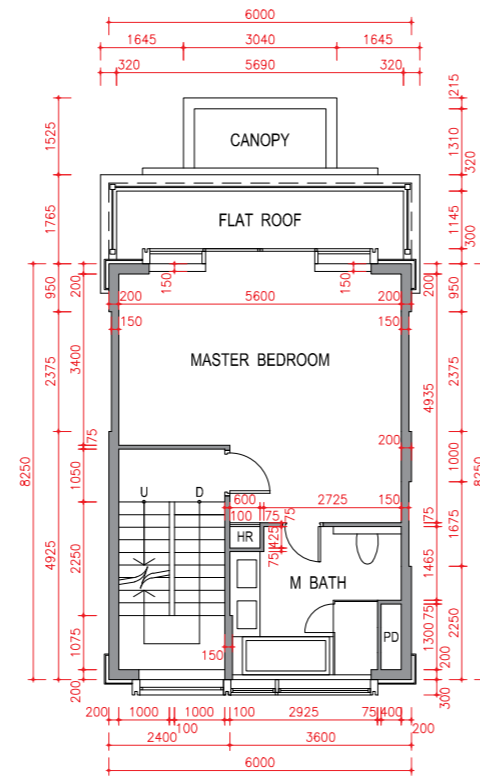
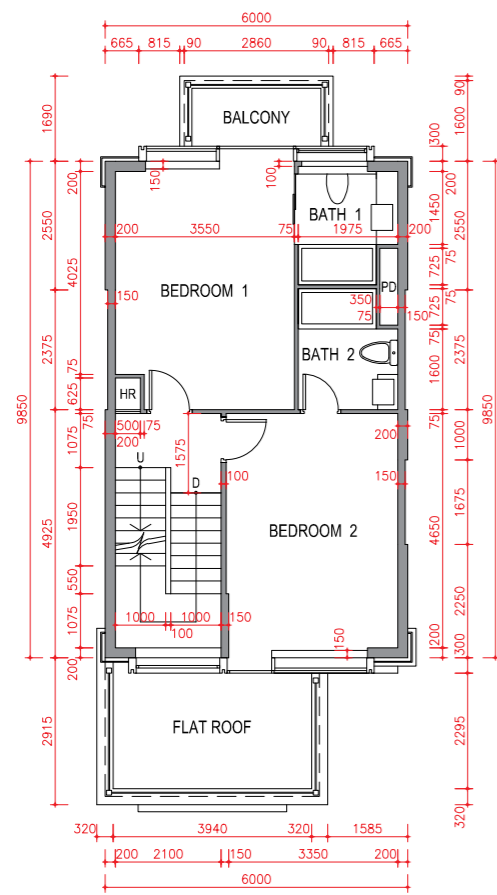
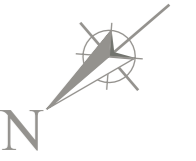

1/F Plan
一樓平面圖

2/F Plan
二樓平面圖

Roof Plan
天台平面圖

Upper Roof Plan
上層天台平面圖

0M / 米 5M / 米
Scale:
比例:

85D Tan Kwai Tsuen Road, Casa Regalia 富豪·悅庭丹桂村路 85D 號

Floor 樓層	The thickness of the floor slabs (excluding plaster) of each House (mm) 每座洋房的樓板(不包括灰泥)的厚度(毫米)	The floor-to-floor height of each House (mm) 每座洋房的層與層之間的高度(毫米)
Basement 地下樓層	-	3650
G/F 地下	150, 175	4150
1/F 一樓	150, 175	3400
2/F 二樓	150	3400
Roof 天台	150	2825

The internal areas of the residential properties on the upper floors will generally be slightly larger than those on the lower floors because of the reducing thickness of the structural walls on the upper floors.

因住宅物業的較高樓層的結構牆的厚度遞減，較高樓層的內部面積，一般比較低樓層的內部面積稍大。

Notes:

- The dimensions of floor plans are all structural dimensions in millimeter.
- There may be architectural features and/or exposed pipes on external walls of DOMUS/Houses. For details, please refer to the latest approved building plans.
- Common pipes exposed and/or enclosed in cladding are located at/adjacent to flat roof and/or external wall of DOMUS/Houses. For details, please refer to the latest approved building plans.
- There are ceiling bulkheads and/or sunken slab of the above Flats/Houses at living/dining room, bedrooms, corridors and/or kitchen of the above Flats/Houses for the air-conditioning system and/or mechanical and electrical services.
- Please refer to page 20 of this sales brochure for legend of the terms and abbreviations shown in the floor plan above.
- Under Special Condition No. (9)(g) of the Land Grant, the total number of residential units erected or to be erected on the Lot shall not be less than 170.
- According to Clause 55 of the Third Schedule to the DMC, no Owner shall demolish or alter the partition walls separating two Residential Units (as defined in the DMC) or a common wall dividing the land upon which two Houses (as defined in the DMC) are constructed or the floor slabs or roof slabs between two Residential Units which will result in such Residential Units being internally linked to and accessible from each other, except with the prior written consent of the Director of Lands or other Government authority in place of him from time to time.

備註：

- 平面圖所列之尺寸數字為以毫米標示之建築尺寸。
- 尚築及洋房外牆設有建築裝飾及/或外露喉管。詳細資料請參考最新批准之建築圖則。
- 尚築及洋房的平台及/或外牆設有外露及/或外牆裝飾板內藏之公用喉管。詳細資料請參考最新批准的建築圖則。
- 大樓及洋房客/飯廳、睡房、走廊及/或廚房有假天花及/或有跌級樓板以內藏冷氣系統及/或機電設備。
- 以上平面圖中顯示之名詞及簡稱請參閱本售樓書第20頁。
- 批地文件特別條款第(9)(g)條規定，在該地段已建或擬建的住宅單位不得少於170個。
- 根據公契附表3第55條，除非已事先獲得地政總署署長或取代地政總署署長的其他政府機構不時作出的同意，否則任何業主不得拆卸或變更分隔兩個住宅單位(定義見公契)的間隔牆、分隔兩間洋房(定義見公契)土地的公用牆、或兩個住宅單位之間的水泥板或屋頂板以致使該等住宅單位能夠在內部連接及互通。

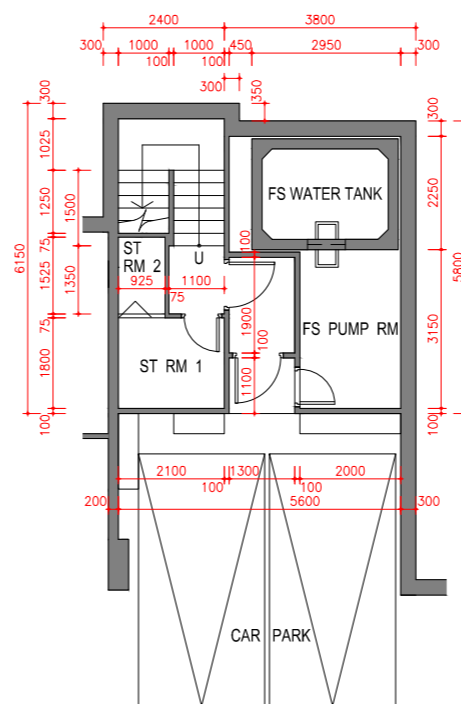

Basement Plan
地庫平面圖

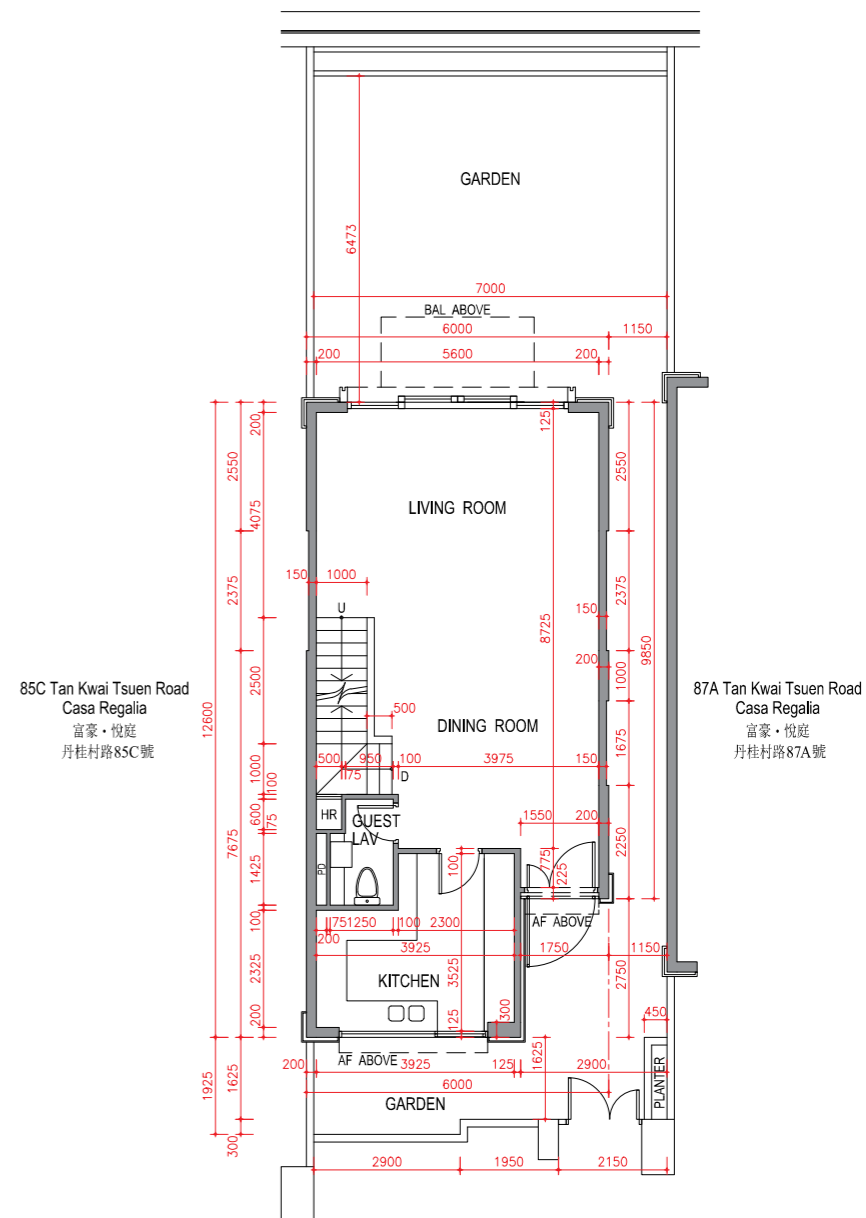

G/F Plan
地面層平面圖

0M / 米
5M / 米
Scale:
比例:

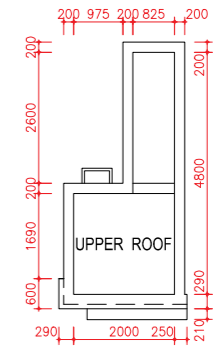
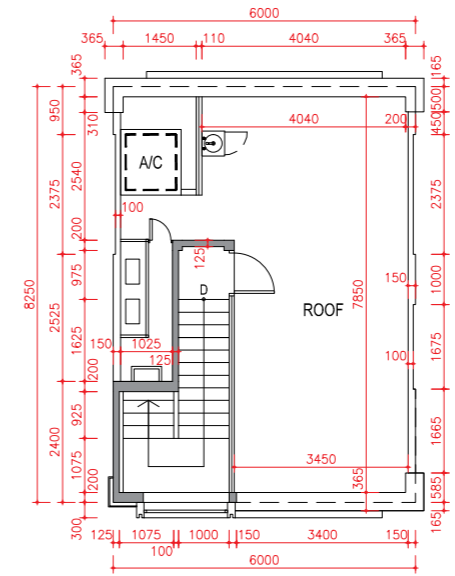
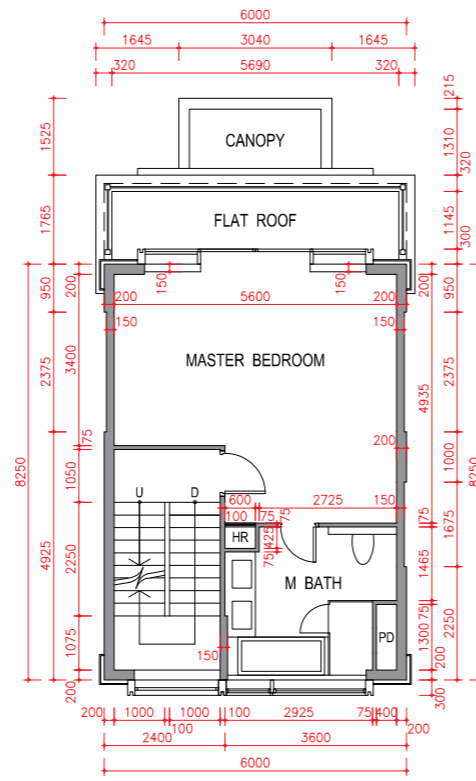
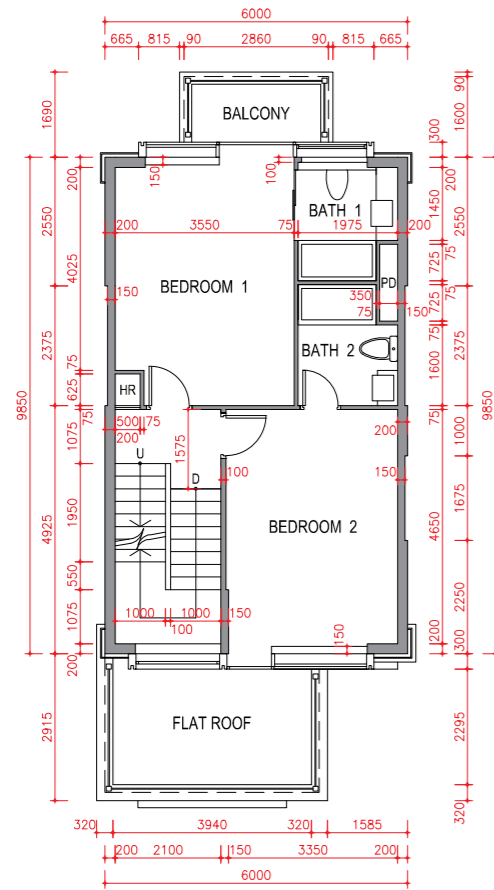
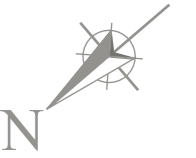

87A Tan Kwai Tsuen Road, Casa Regalia 富豪·悅庭丹桂村路 87A 號



Floor 樓層	The thickness of the floor slabs (excluding plaster) of each House (mm) 每座洋房的樓板(不包括灰泥)的厚度(毫米)	The floor-to-floor height of each House (mm) 每座洋房的層與層之間的高度(毫米)
Basement 地下樓層	-	3650
G/F 地下	150, 175	4150
1/F 一樓	150, 175	3400
2/F 二樓	150	3400
Roof 天台	150	2825

The internal areas of the residential properties on the upper floors will generally be slightly larger than those on the lower floors because of the reducing thickness of the structural walls on the upper floors.

因住宅物業的較高樓層的結構牆的厚度遞減，較高樓層的內部面積，一般比較低樓層的內部面積稍大。

Notes:

- The dimensions of floor plans are all structural dimensions in millimeter.
- There may be architectural features and/or exposed pipes on external walls of DOMUS/Houses. For details, please refer to the latest approved building plans.
- Common pipes exposed and/or enclosed in cladding are located at/adjacent to flat roof and/or external wall of DOMUS/Houses. For details, please refer to the latest approved building plans.
- There are ceiling bulkheads and/or sunken slab of the above Flats/Houses at living/dining room, bedrooms, corridors and/or kitchen of the above Flats/Houses for the air-conditioning system and/or mechanical and electrical services.
- Please refer to page 20 of this sales brochure for legend of the terms and abbreviations shown in the floor plan above.
- Under Special Condition No. (9)(g) of the Land Grant, the total number of residential units erected or to be erected on the Lot shall not be less than 170.
- According to Clause 55 of the Third Schedule to the DMC, no Owner shall demolish or alter the partition walls separating two Residential Units (as defined in the DMC) or a common wall dividing the land upon which two Houses (as defined in the DMC) are constructed or the floor slabs or roof slabs between two Residential Units which will result in such Residential Units being internally linked to and accessible from each other, except with the prior written consent of the Director of Lands or other Government authority in place of him from time to time.

備註：

- 平面圖所列之尺寸數字為以毫米標示之建築尺寸。
- 尚築及洋房外牆設有建築裝飾及/或外露喉管。詳細資料請參考最新批准之建築圖則。
- 尚築及洋房的平台及/或外牆設有外露及/或外牆裝飾板內藏之公用喉管。詳細資料請參考最新批准的建築圖則。
- 大樓及洋房客/飯廳、睡房、走廊及/或廚房有假天花及/或有跌級樓板以內藏冷氣系統及/或機電設備。
- 以上平面圖中顯示之名詞及簡稱請參閱本售樓書第20頁。
- 批地文件特別條款第(9)(g)條規定，在該地段已建或擬建的住宅單位不得少於170個。
- 根據公契附表3第55條，除非已事先獲得地政總署署長或取代地政總署署長的其他政府機構不時作出的同意，否則任何業主不得拆卸或變更分隔兩個住宅單位(定義見公契)的間隔牆、分隔兩間洋房(定義見公契)土地的公用牆、或兩個住宅單位之間的水泥板或屋頂板以致使該等住宅單位能夠在內部連接及互通。

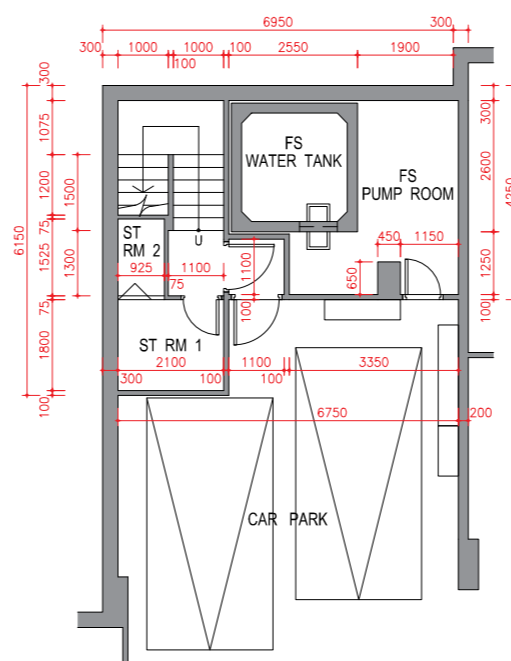

Basement Plan
地庫平面圖

85D Tan Kwai Tsuen Road
Casa Regalia
富豪·悅庭
丹桂村路 85D 號

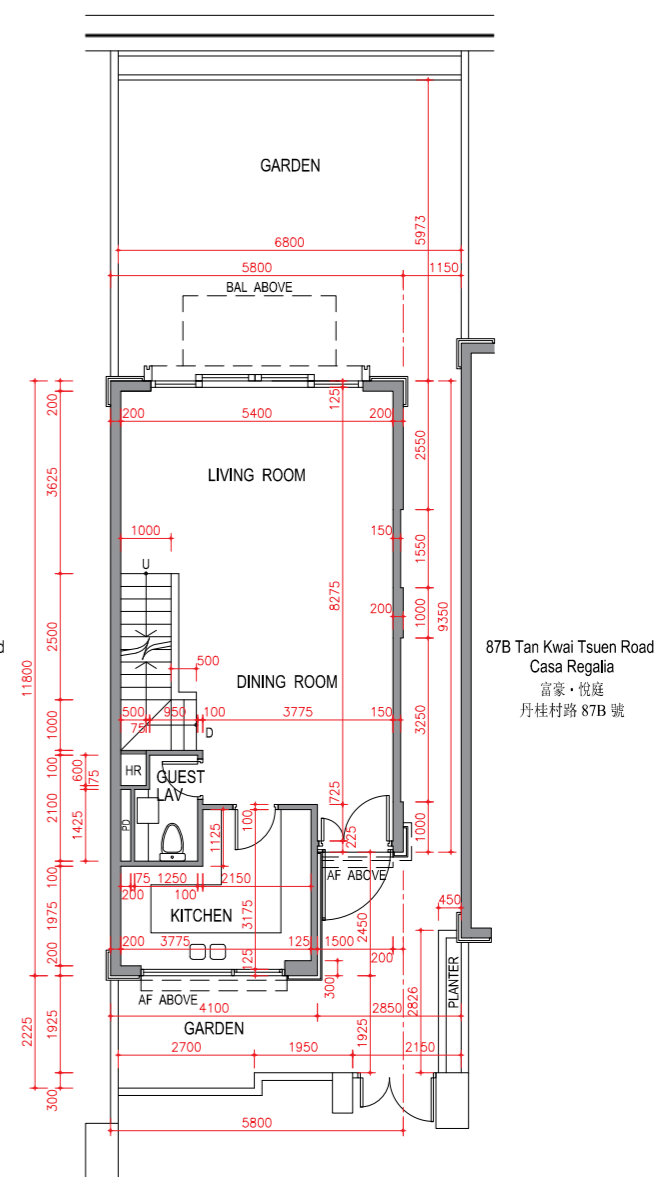

G/F Plan
地面層平面圖

87B Tan Kwai Tsuen Road
Casa Regalia
富豪·悅庭
丹桂村路 87B 號

Scale: 0M / 米 5M / 米
比例:

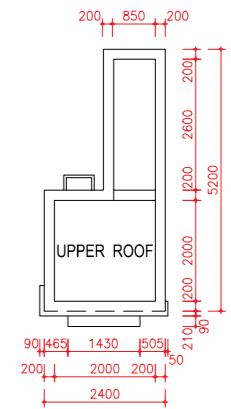
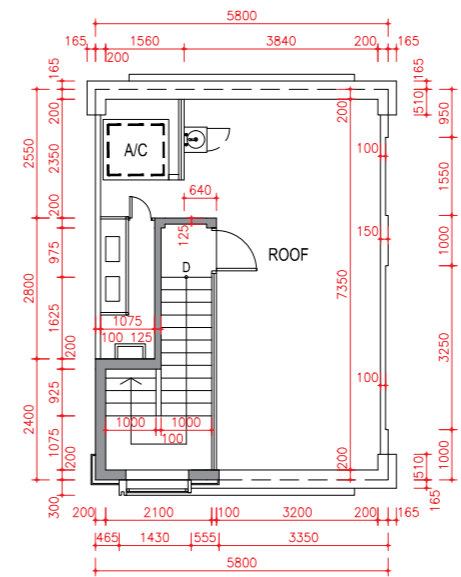
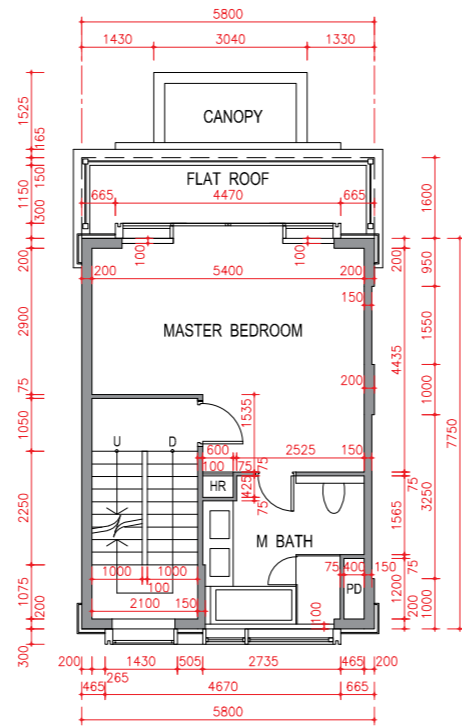
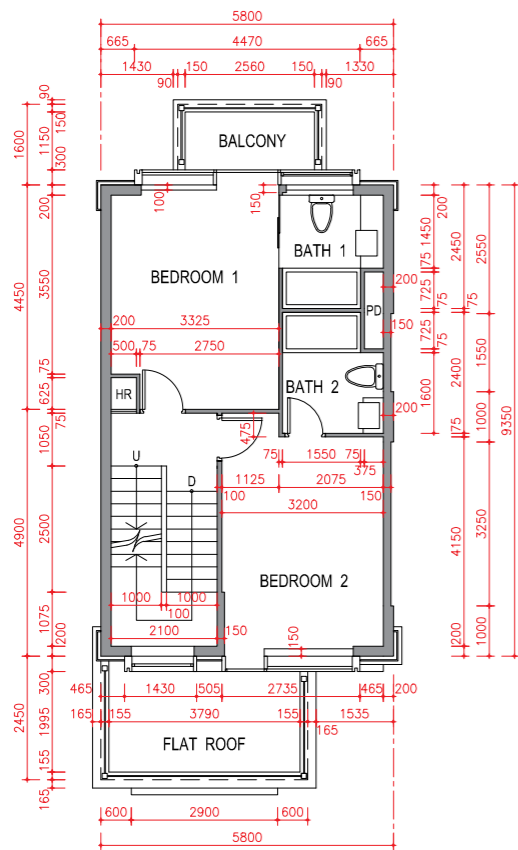
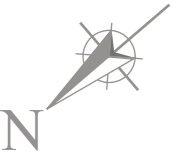

87B Tan Kwai Tsuen Road, Casa Regalia 富豪·悅庭丹桂村路 87B 號



Floor 樓層	The thickness of the floor slabs (excluding plaster) of each House (mm) 每座洋房的樓板(不包括灰泥)的厚度(毫米)	The floor-to-floor height of each House (mm) 每座洋房的層與層之間的高度(毫米)
Basement 地下樓層	-	3650
G/F 地下	150, 175	4150
1/F 一樓	150, 175	3400
2/F 二樓	150	3400
Roof 天台	150	2825

The internal areas of the residential properties on the upper floors will generally be slightly larger than those on the lower floors because of the reducing thickness of the structural walls on the upper floors.

因住宅物業的較高樓層的結構牆的厚度遞減，較高樓層的內部面積，一般比較低樓層的內部面積稍大。

Notes:

- The dimensions of floor plans are all structural dimensions in millimeter.
- There may be architectural features and/or exposed pipes on external walls of DOMUS/Houses. For details, please refer to the latest approved building plans.
- Common pipes exposed and/or enclosed in cladding are located at/adjacent to flat roof and/or external wall of DOMUS/Houses. For details, please refer to the latest approved building plans.
- There are ceiling bulkheads and/or sunken slab of the above Flats/Houses at living/dining room, bedrooms, corridors and/or kitchen of the above Flats/Houses for the air-conditioning system and/or mechanical and electrical services.
- Please refer to page 20 of this sales brochure for legend of the terms and abbreviations shown in the floor plan above.
- Under Special Condition No. (9)(g) of the Land Grant, the total number of residential units erected or to be erected on the Lot shall not be less than 170.
- According to Clause 55 of the Third Schedule to the DMC, no Owner shall demolish or alter the partition walls separating two Residential Units (as defined in the DMC) or a common wall dividing the land upon which two Houses (as defined in the DMC) are constructed or the floor slabs or roof slabs between two Residential Units which will result in such Residential Units being internally linked to and accessible from each other, except with the prior written consent of the Director of Lands or other Government authority in place of him from time to time.

備註：

- 平面圖所列之尺寸數字為以毫米標示之建築尺寸。
- 尚築及洋房外牆設有建築裝飾及/或外露喉管。詳細資料請參考最新批准之建築圖則。
- 尚築及洋房的平台及/或外牆設有外露及/或外牆裝飾板內藏之公用喉管。詳細資料請參考最新批准的建築圖則。
- 大樓及洋房客/飯廳、睡房、走廊及/或廚房有假天花及/或有跌級樓板以內藏冷氣系統及/或機電設備。
- 以上平面圖中顯示之名詞及簡稱請參閱本售樓書第20頁。
- 批地文件特別條款第(9)(g)條規定，在該地段已建或擬建的住宅單位不得少於170個。
- 根據公契附表3第55條，除非已事先獲得地政總署署長或取代地政總署署長的其他政府機構不時作出的同意，否則任何業主不得拆卸或變更分隔兩個住宅單位(定義見公契)的間隔牆、分隔兩間洋房(定義見公契)土地的公用牆、或兩個住宅單位之間的水泥板或屋頂板以致使該等住宅單位能夠在內部連接及互通。

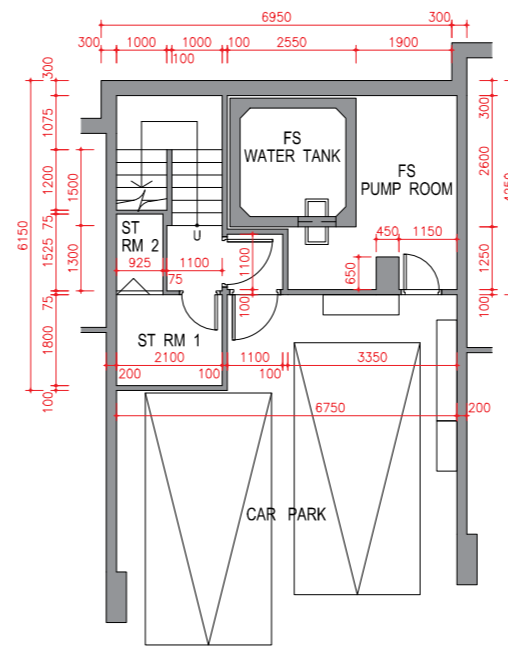

Basement Plan
地庫平面圖

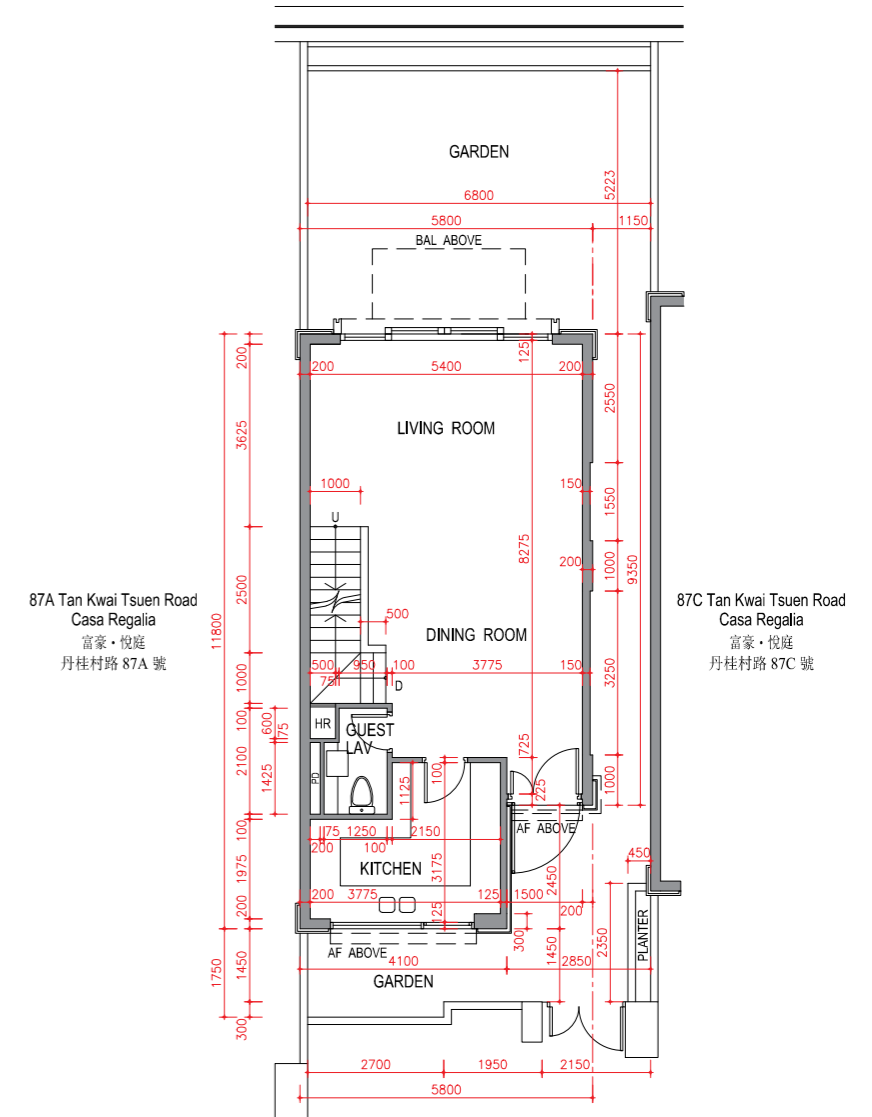

G/F Plan
地面層平面圖

0M / 米
Scale:
比例: 5M / 米

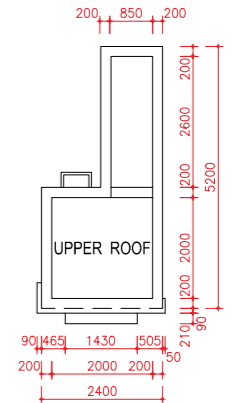
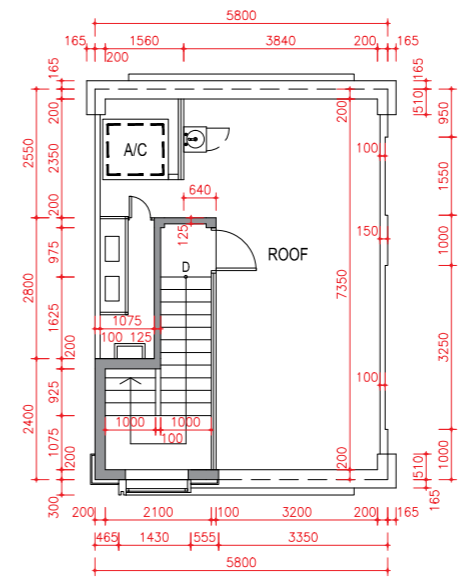
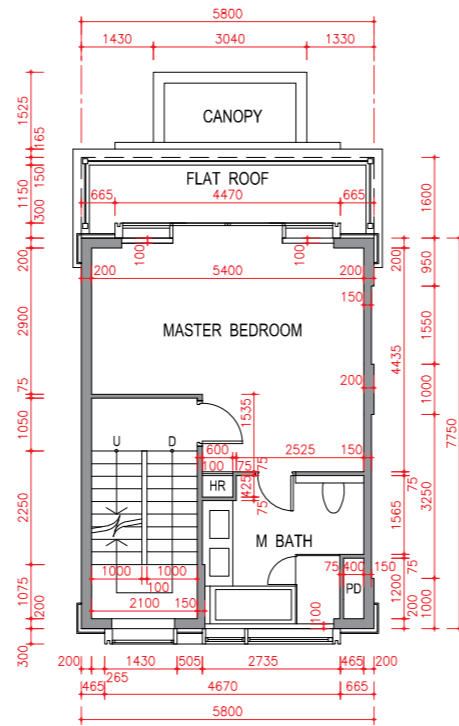
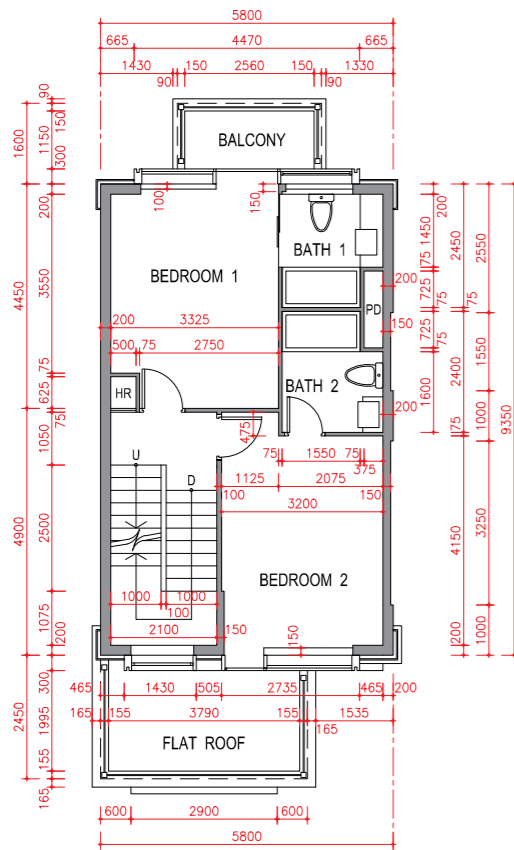
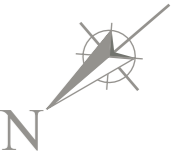

1/F Plan
一樓平面圖

2/F Plan
二樓平面圖

Roof Plan
天台平面圖

Upper Roof Plan
上層天台平面圖

0M / 米 5M / 米
Scale:
比例:

87C Tan Kwai Tsuen Road, Casa Regalia 富豪·悅庭丹桂村路 87C 號

Floor 樓層	The thickness of the floor slabs (excluding plaster) of each House (mm) 每座洋房的樓板(不包括灰泥)的厚度(毫米)	The floor-to-floor height of each House (mm) 每座洋房的層與層之間的高度(毫米)
Basement 地下樓層	-	3650
G/F 地下	150, 175	4150
1/F 一樓	150, 175	3400
2/F 二樓	150	3400
Roof 天台	150	2825

The internal areas of the residential properties on the upper floors will generally be slightly larger than those on the lower floors because of the reducing thickness of the structural walls on the upper floors.

因住宅物業的較高樓層的結構牆的厚度遞減，較高樓層的內部面積，一般比較低樓層的內部面積稍大。

Notes:

- The dimensions of floor plans are all structural dimensions in millimeter.
- There may be architectural features and/or exposed pipes on external walls of DOMUS/Houses. For details, please refer to the latest approved building plans.
- Common pipes exposed and/or enclosed in cladding are located at/adjacent to flat roof and/or external wall of DOMUS/Houses. For details, please refer to the latest approved building plans.
- There are ceiling bulkheads and/or sunken slab of the above Flats/Houses at living/dining room, bedrooms, corridors and/or kitchen of the above Flats/Houses for the air-conditioning system and/or mechanical and electrical services.
- Please refer to page 20 of this sales brochure for legend of the terms and abbreviations shown in the floor plan above.
- Under Special Condition No. (9)(g) of the Land Grant, the total number of residential units erected or to be erected on the Lot shall not be less than 170.
- According to Clause 55 of the Third Schedule to the DMC, no Owner shall demolish or alter the partition walls separating two Residential Units (as defined in the DMC) or a common wall dividing the land upon which two Houses (as defined in the DMC) are constructed or the floor slabs or roof slabs between two Residential Units which will result in such Residential Units being internally linked to and accessible from each other, except with the prior written consent of the Director of Lands or other Government authority in place of him from time to time.

備註：

- 平面圖所列之尺寸數字為以毫米標示之建築尺寸。
- 尚築及洋房外牆設有建築裝飾及/或外露喉管。詳細資料請參考最新批准之建築圖則。
- 尚築及洋房的平台及/或外牆設有外露及/或外牆裝飾板內藏之公用喉管。詳細資料請參考最新批准的建築圖則。
- 大樓及洋房客/飯廳、睡房、走廊及/或廚房有假天花及/或有跌級樓板以內藏冷氣系統及/或機電設備。
- 以上平面圖中顯示之名詞及簡稱請參閱本售樓書第20頁。
- 批地文件特別條款第(9)(g)條規定，在該地段已建或擬建的住宅單位不得少於170個。
- 根據公契附表3第55條，除非已事先獲得地政總署署長或取代地政總署署長的其他政府機構不時的同意，否則任何業主不得拆卸或變更分隔兩個住宅單位(定義見公契)的間隔牆、分隔兩間洋房(定義見公契)土地的公用牆、或兩個住宅單位之間的水泥板或屋頂板以致使該等住宅單位能夠在內部連接及互通。

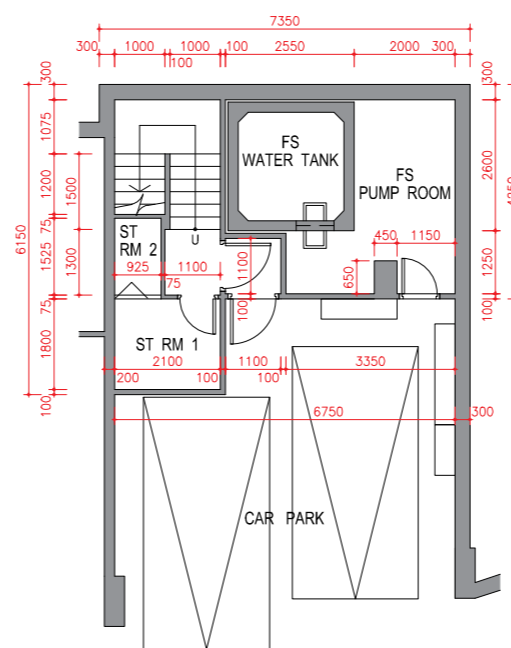

Basement Plan
地庫平面圖

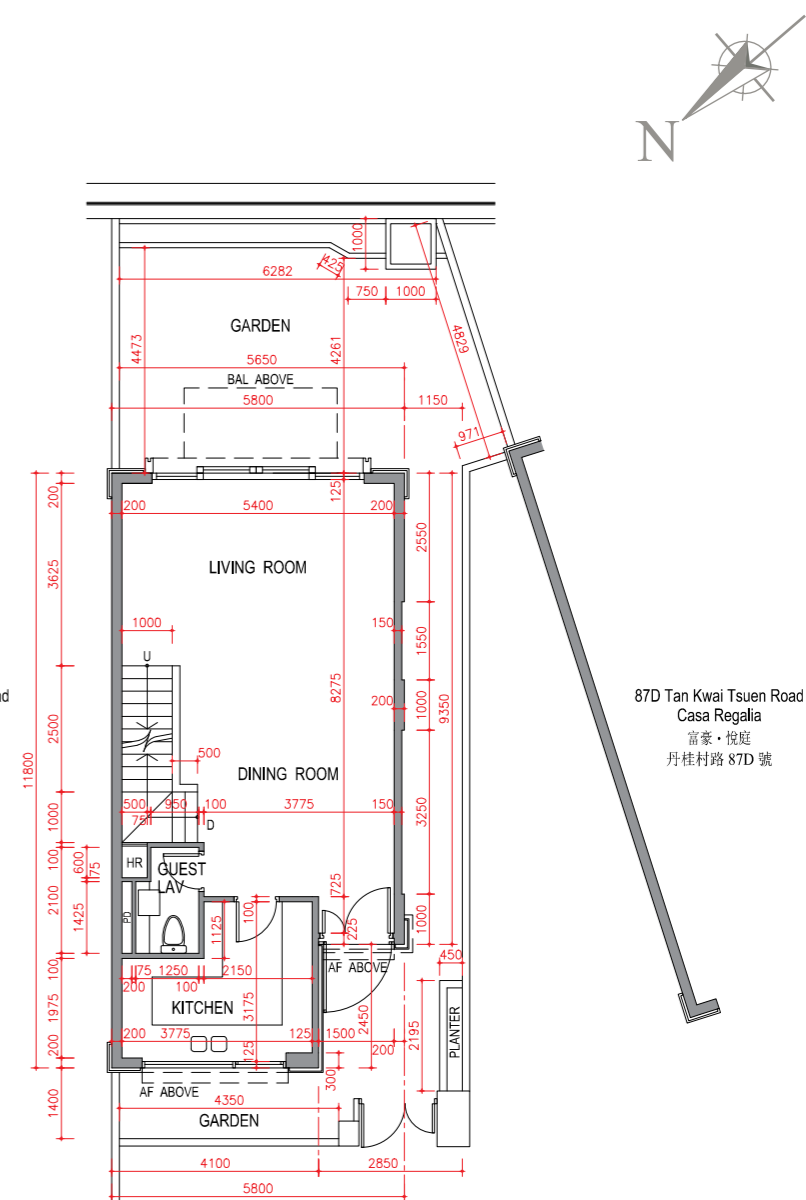

G/F Plan
地面層平面圖

Scale: 0M / 米 5M / 米
比例:

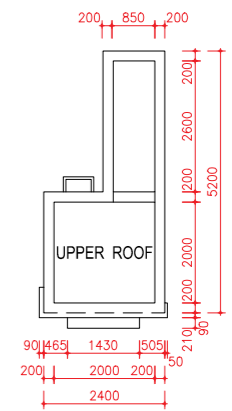
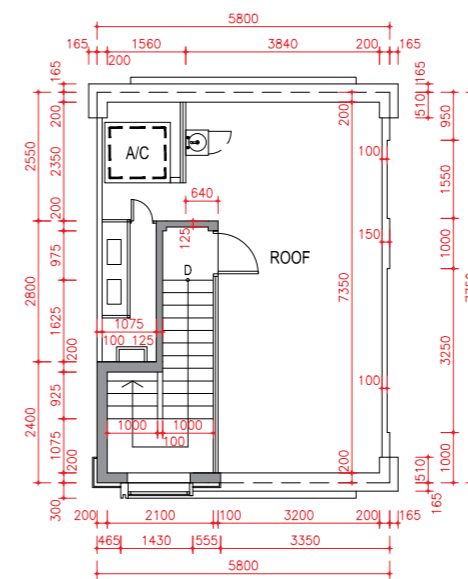
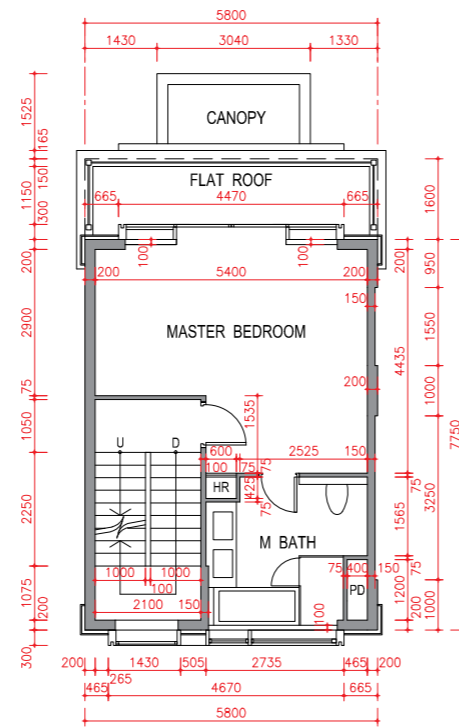
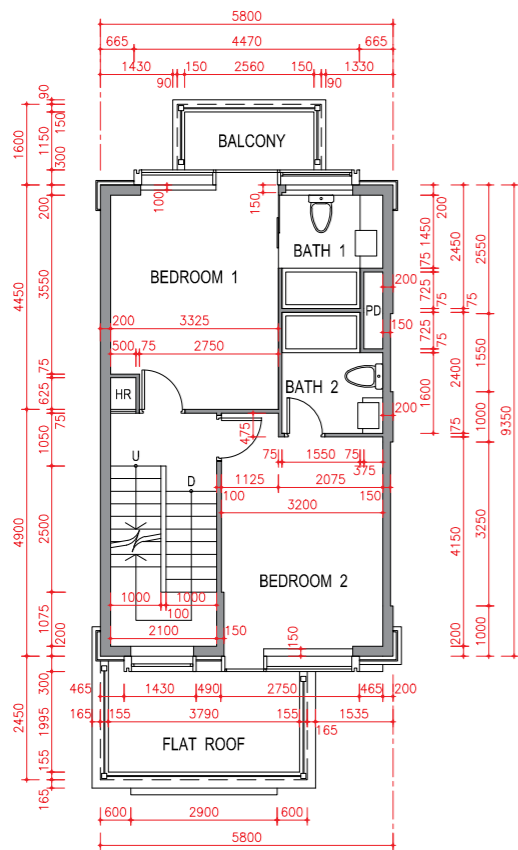
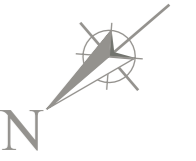

87D Tan Kwai Tsuen Road, Casa Regalia 富豪·悅庭丹桂村路 87D 號



Floor 樓層	The thickness of the floor slabs (excluding plaster) of each House (mm) 每座洋房的樓板(不包括灰泥)的厚度(毫米)	The floor-to-floor height of each House (mm) 每座洋房的層與層之間的高度(毫米)
Basement 地下樓層	-	3650
G/F 地下	150, 175	4150
1/F 一樓	150, 175	3400
2/F 二樓	150	3400
Roof 天台	150	2825

The internal areas of the residential properties on the upper floors will generally be slightly larger than those on the lower floors because of the reducing thickness of the structural walls on the upper floors.

因住宅物業的較高樓層的結構牆的厚度遞減，較高樓層的內部面積，一般比較低樓層的內部面積稍大。

Notes:

- The dimensions of floor plans are all structural dimensions in millimeter.
- There may be architectural features and/or exposed pipes on external walls of DOMUS/Houses. For details, please refer to the latest approved building plans.
- Common pipes exposed and/or enclosed in cladding are located at/adjacent to flat roof and/or external wall of DOMUS/Houses. For details, please refer to the latest approved building plans.
- There are ceiling bulkheads and/or sunken slab of the above Flats/Houses at living/dining room, bedrooms, corridors and/or kitchen of the above Flats/Houses for the air-conditioning system and/or mechanical and electrical services.
- Please refer to page 20 of this sales brochure for legend of the terms and abbreviations shown in the floor plan above.
- Under Special Condition No. (9)(g) of the Land Grant, the total number of residential units erected or to be erected on the Lot shall not be less than 170.
- According to Clause 55 of the Third Schedule to the DMC, no Owner shall demolish or alter the partition walls separating two Residential Units (as defined in the DMC) or a common wall dividing the land upon which two Houses (as defined in the DMC) are constructed or the floor slabs or roof slabs between two Residential Units which will result in such Residential Units being internally linked to and accessible from each other, except with the prior written consent of the Director of Lands or other Government authority in place of him from time to time.

備註：

- 平面圖所列之尺寸數字為以毫米標示之建築尺寸。
- 尚築及洋房外牆設有建築裝飾及/或外露喉管。詳細資料請參考最新批准之建築圖則。
- 尚築及洋房的平台及/或外牆設有外露及/或外牆裝飾板內藏之公用喉管。詳細資料請參考最新批准的建築圖則。
- 大樓及洋房客/飯廳、睡房、走廊及/或廚房有假天花及/或有跌級樓板以內藏冷氣系統及/或機電設備。
- 以上平面圖中顯示之名詞及簡稱請參閱本售樓書第20頁。
- 批地文件特別條款第(9)(g)條規定，在該地段已建或擬建的住宅單位不得少於170個。
- 根據公契附表3第55條，除非已事先獲得地政總署署長或取代地政總署署長的其他政府機構不時的同意，否則任何業主不得拆卸或變更分隔兩個住宅單位(定義見公契)的間隔牆、分隔兩間洋房(定義見公契)土地的公用牆、或兩個住宅單位之間的水泥板或屋頂板以致使該等住宅單位能夠在內部連接及互通。

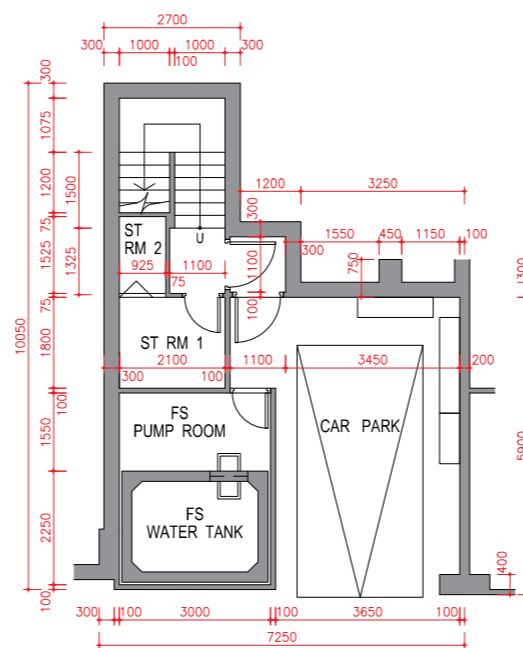

Basement Plan
地庫平面圖

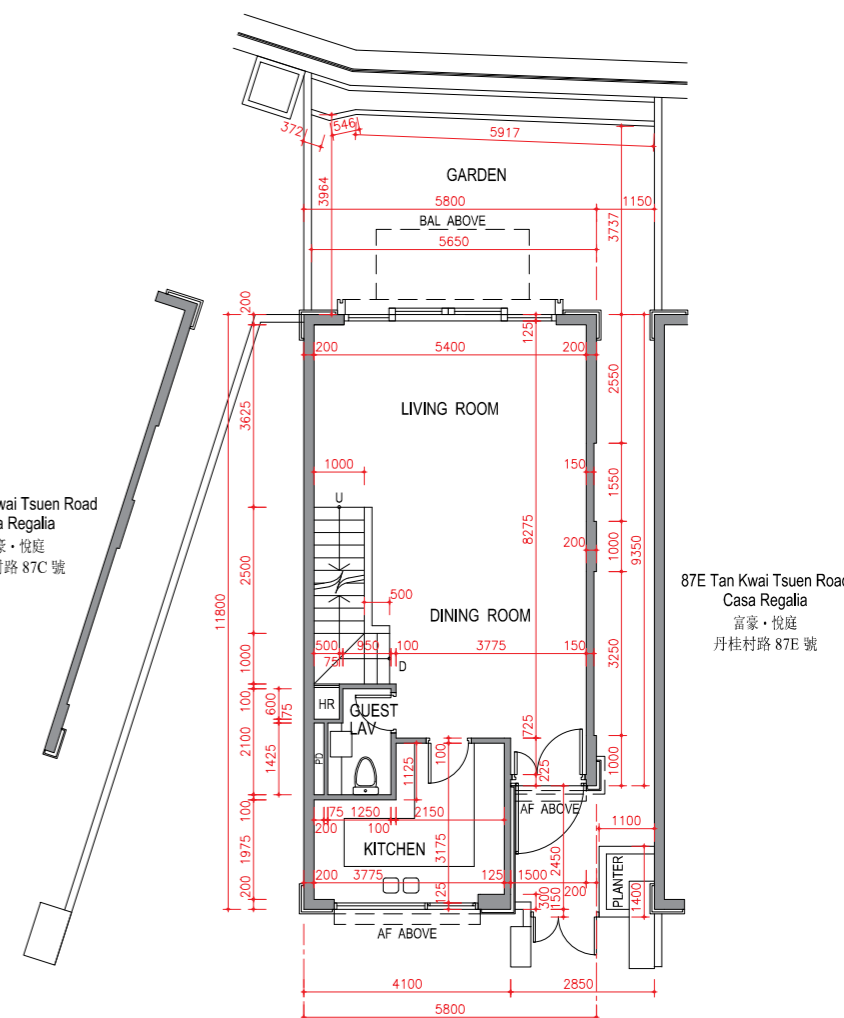

G/F Plan
地面層平面圖

Scale:
比例: 0M / 米 5M / 米

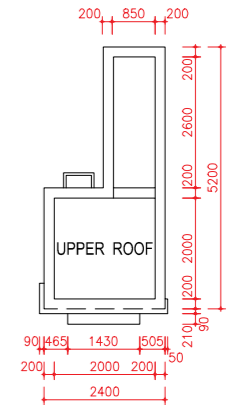
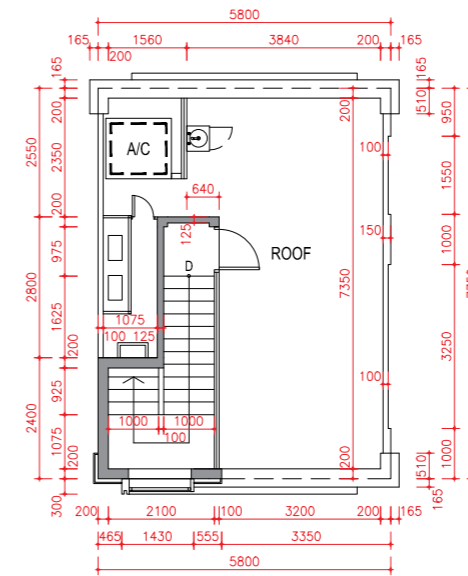
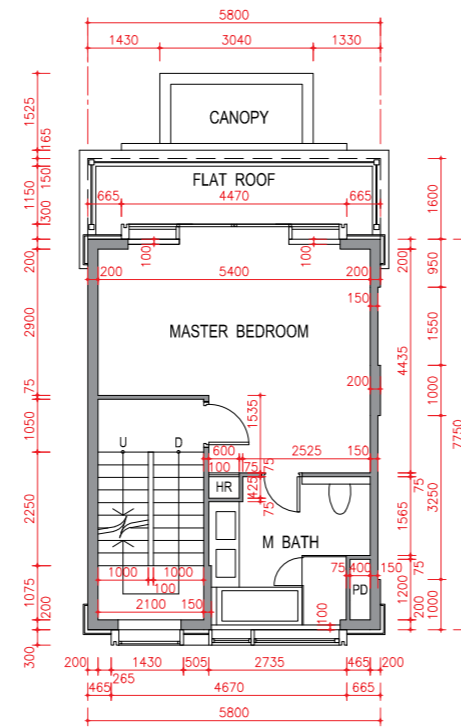
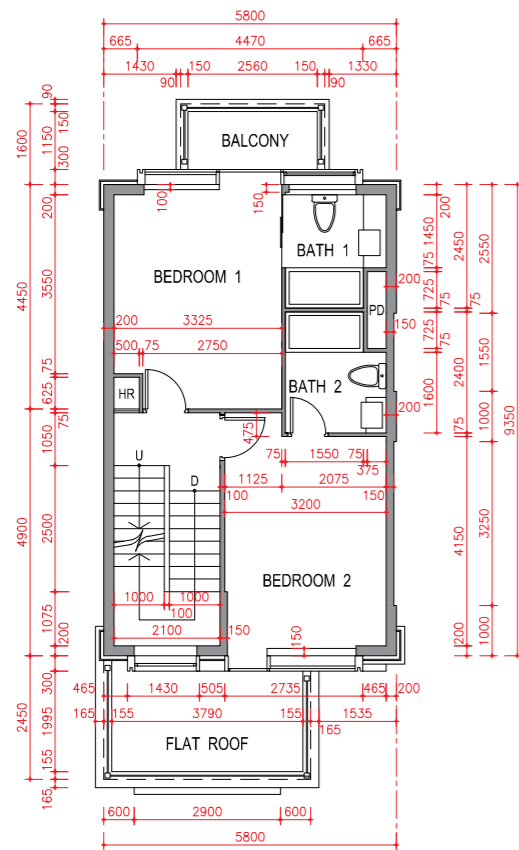
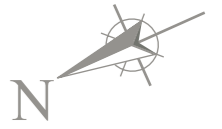

1/F Plan
一樓平面圖

2/F Plan
二樓平面圖

Roof Plan
天台平面圖

Upper Roof Plan
上層天台平面圖

Scale: 0M / 米 5M / 米
比例:

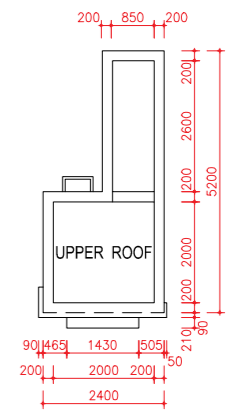
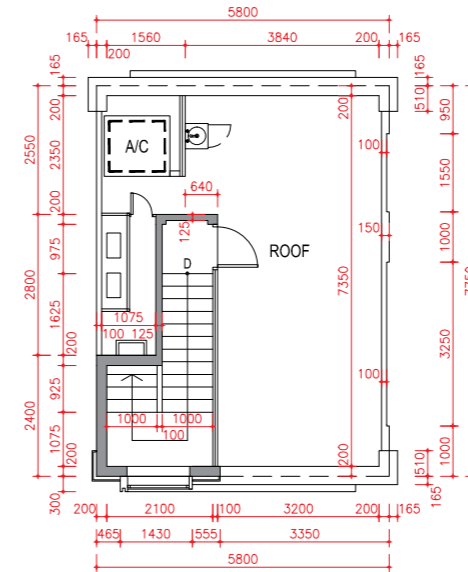
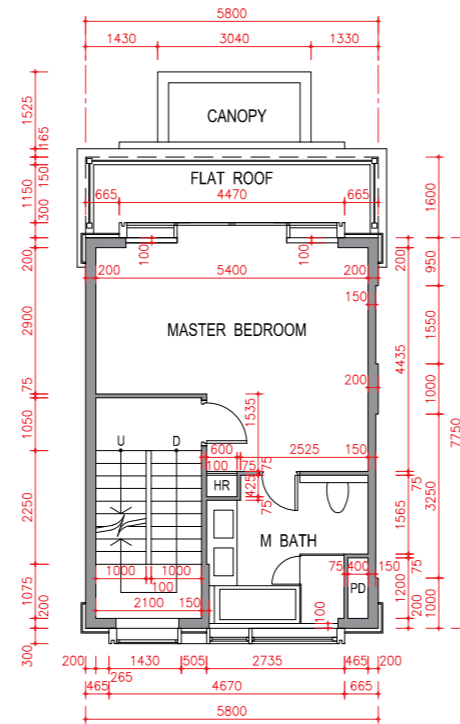
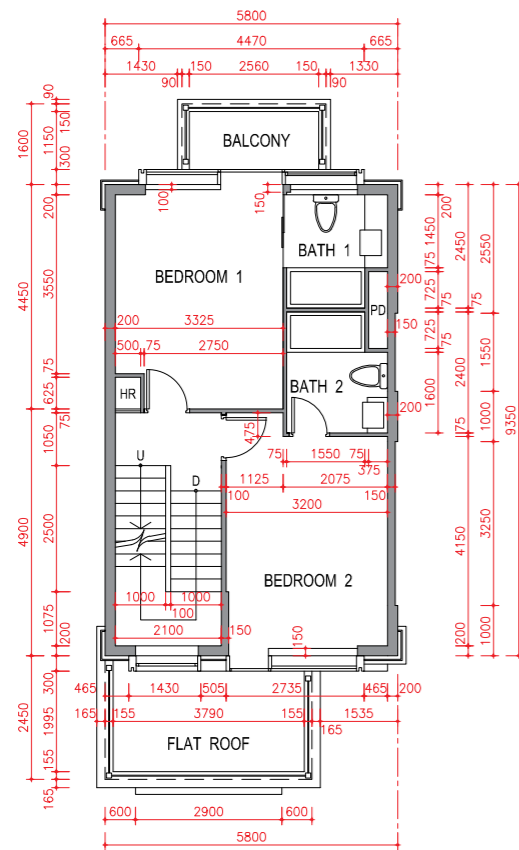
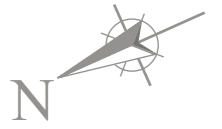

Upper Roof Plan
上層天台平面圖

0M / 米 5M / 米
Scale:
比例:

89 Tan Kwai Tsuen Road, Casa Regalia 富豪·悦庭丹桂村路 89 號



Floor 樓層	The thickness of the floor slabs (excluding plaster) of each House (mm) 每座洋房的樓板 (不包括灰泥)的厚度(毫米)	The floor-to-floor height of each House (mm) 每座洋房的層與層之間 的高度(毫米)
Basement 地下樓層	-	3710
G/F 地下	150, 175	4200
1/F 一樓	150	3450
2/F 二樓	150, 200	3450
Roof 天台	150, 200	2825

The internal areas of the residential properties on the upper floors will generally be slightly larger than those on the lower floors because of the reducing thickness of the structural walls on the upper floors.

因住宅物業的較高樓層的結構牆的厚度遞減，較高樓層的內部面積，一般比較低樓層的內部面積稍大。

Notes:

- The dimensions of floor plans are all structural dimensions in millimeter.
- There may be architectural features and/or exposed pipes on external walls of DOMUS/Houses. For details, please refer to the latest approved building plans.
- Common pipes exposed and/or enclosed in cladding are located at/adjacent to flat roof and/or external wall of DOMUS/Houses. For details, please refer to the latest approved building plans.
- There are ceiling bulkheads and/or sunken slab of the above Flats/Houses at living/dining room, bedrooms, corridors and/or kitchen of the above Flats/Houses for the air-conditioning system and/or mechanical and electrical services.
- Please refer to page 20 of this sales brochure for legend of the terms and abbreviations shown in the floor plan above.
- Under Special Condition No. (9)(g) of the Land Grant, the total number of residential units erected or to be erected on the Lot shall not be less than 170.
- According to Clause 55 of the Third Schedule to the DMC, no Owner shall demolish or alter the partition walls separating two Residential Units (as defined in the DMC) or a common wall dividing the land upon which two Houses (as defined in the DMC) are constructed or the floor slabs or roof slabs between two Residential Units which will result in such Residential Units being internally linked to and accessible from each other, except with the prior written consent of the Director of Lands or other Government authority in place of him from time to time.

備註：

- 平面圖所列之尺寸數字為以毫米標示之建築尺寸。
- 尚築及洋房外牆設有建築裝飾及/或外置喉管。詳細資料請參考最新批准之建築圖則。
- 尚築及洋房的平台及/或外牆設有外置及/或外牆裝飾板內藏之公用喉管。詳細資料請參考最新批准的建築圖則。
- 大樓及洋房客/飯廳、睡房、走廊及/或廚房有假天花及/或有跌級樓板以內藏冷氣系統及/或機電設備。
- 以上平面圖中顯示之名詞及簡稱請參閱本售樓書第20頁。
- 批地文件特別條款第(9)(g)條規定，在該地段已建或擬建的住宅單位不得少於170個。
- 根據公契附表3第55條，除非已事先獲得地政總署署長或取代地政總署署長的其他政府機構不時作出的同意，否則任何業主不得拆卸或變更分隔兩個住宅單位(定義見公契)的間隔牆、分隔兩間洋房(定義見公契)土地的公用牆、或兩個住宅單位之間的水泥板或屋頂板以致使該等住宅單位能夠在內部連接及互通。

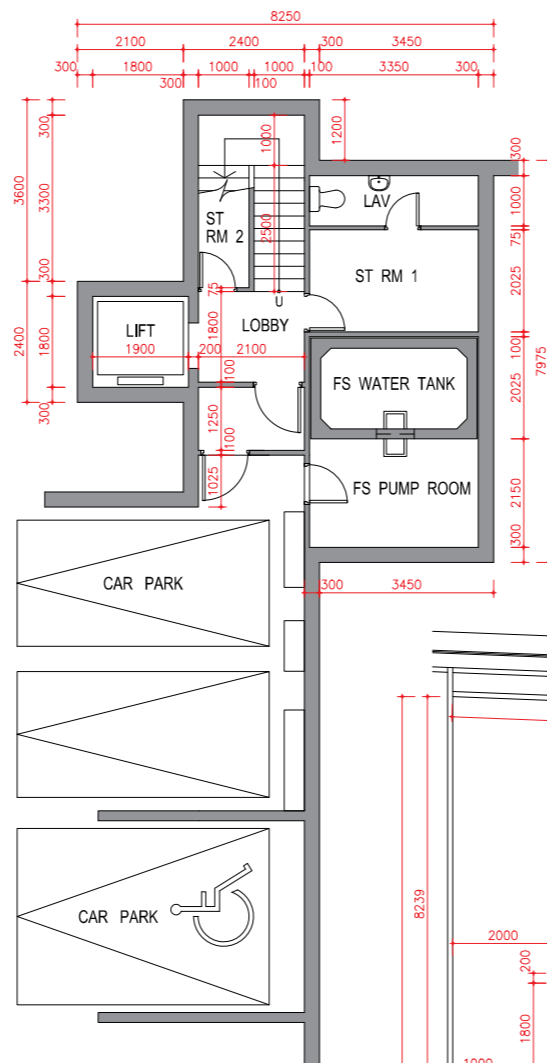

Basement Plan
地庫平面圖

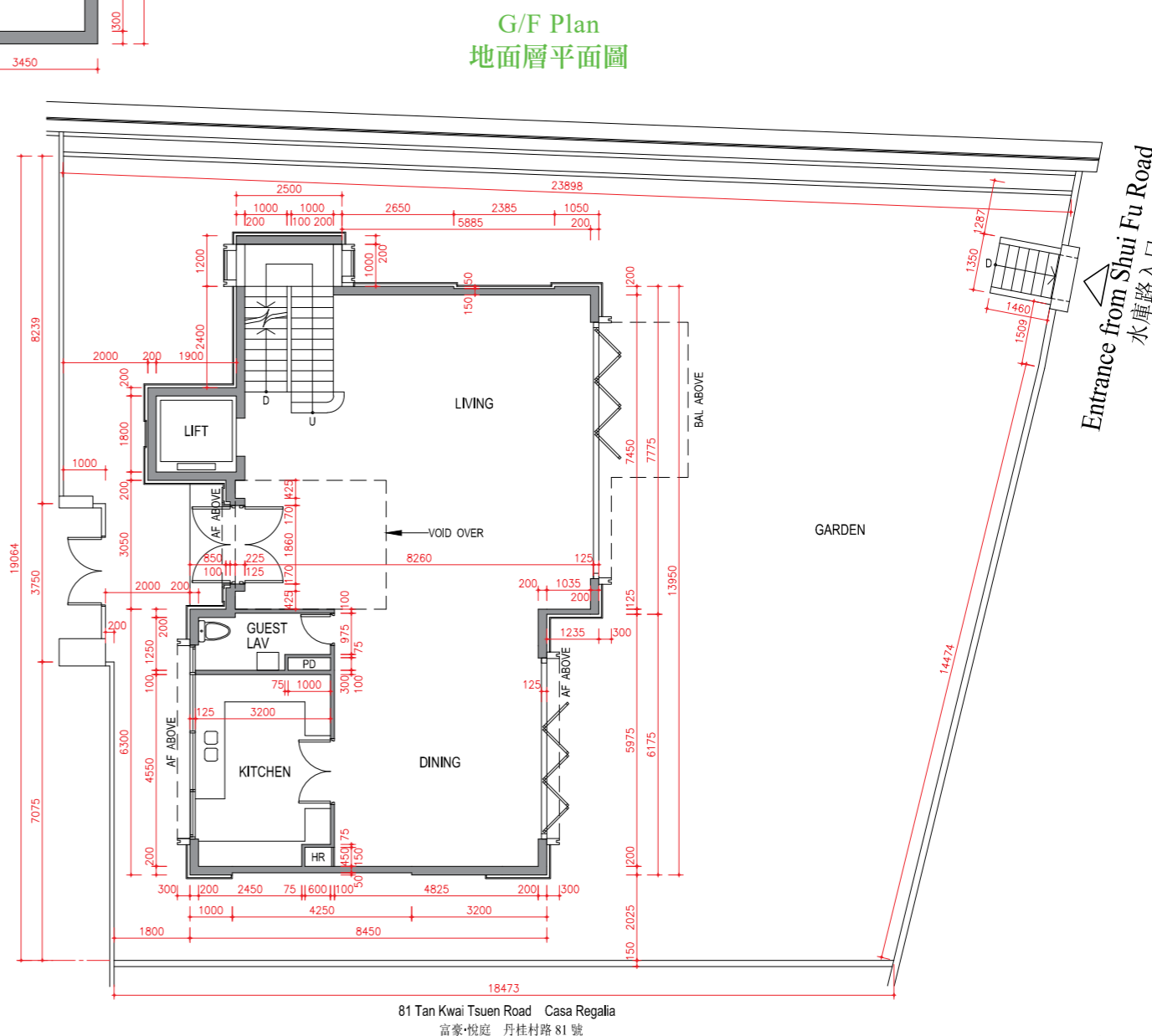

81 Tan Kwai Tsuen Road Casa Regalia
富豪·悦庭 丹桂村路 81 號

0M / 米 5M / 米
Scale:
比例:

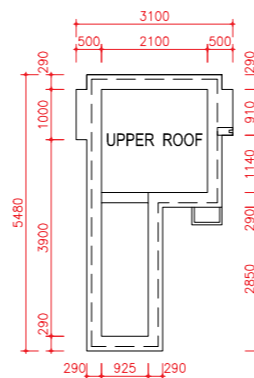
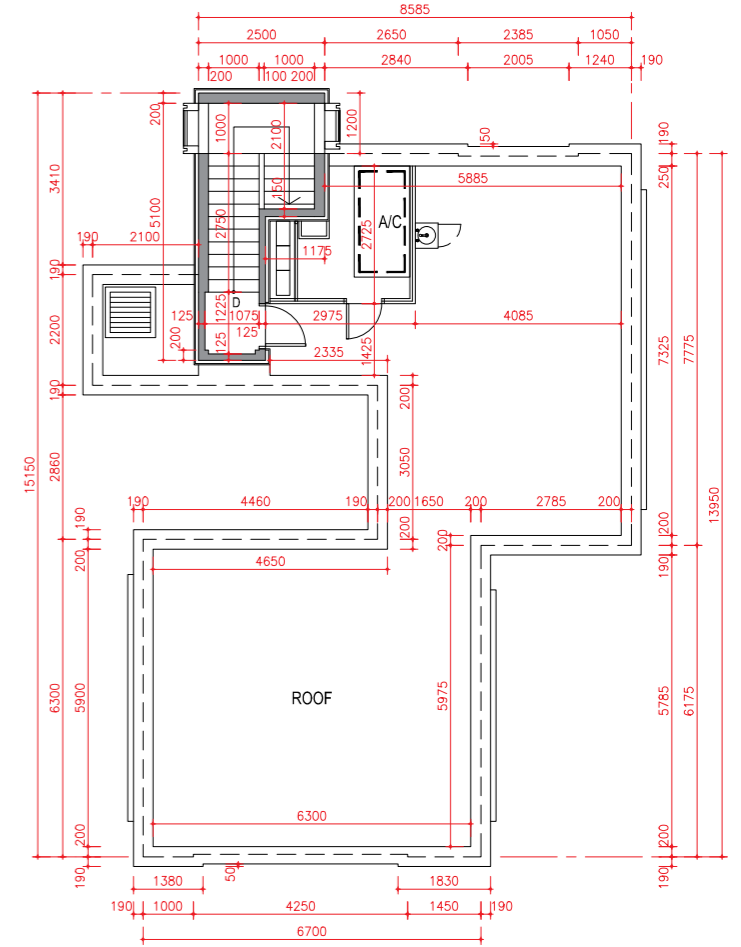
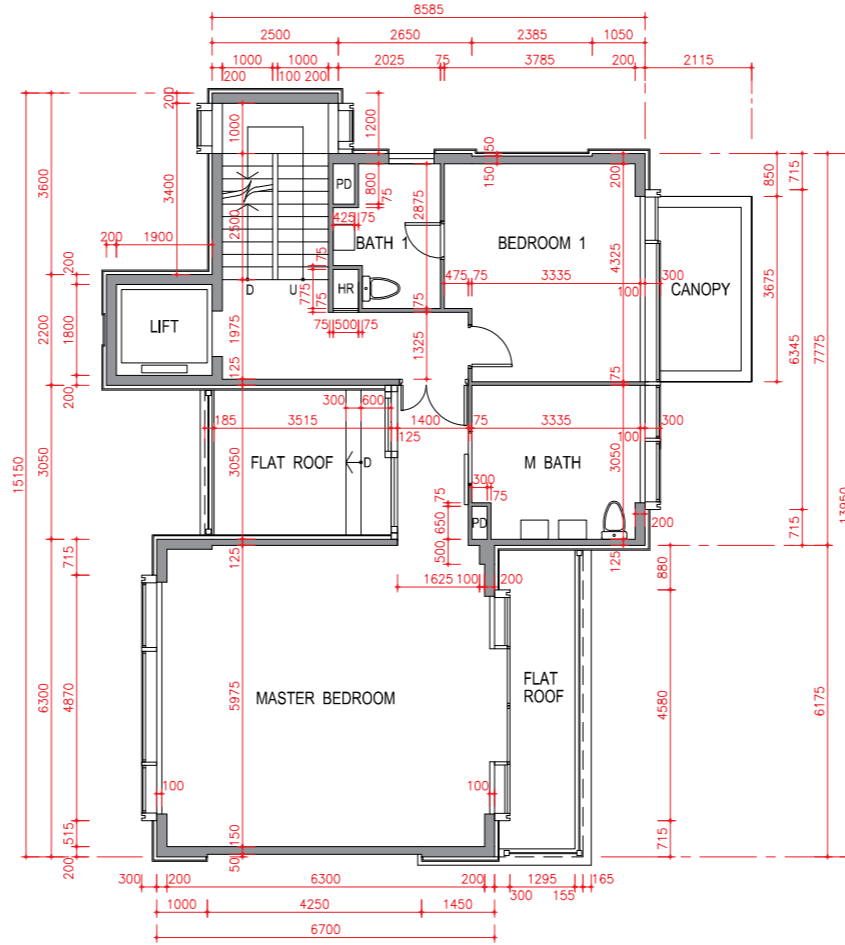
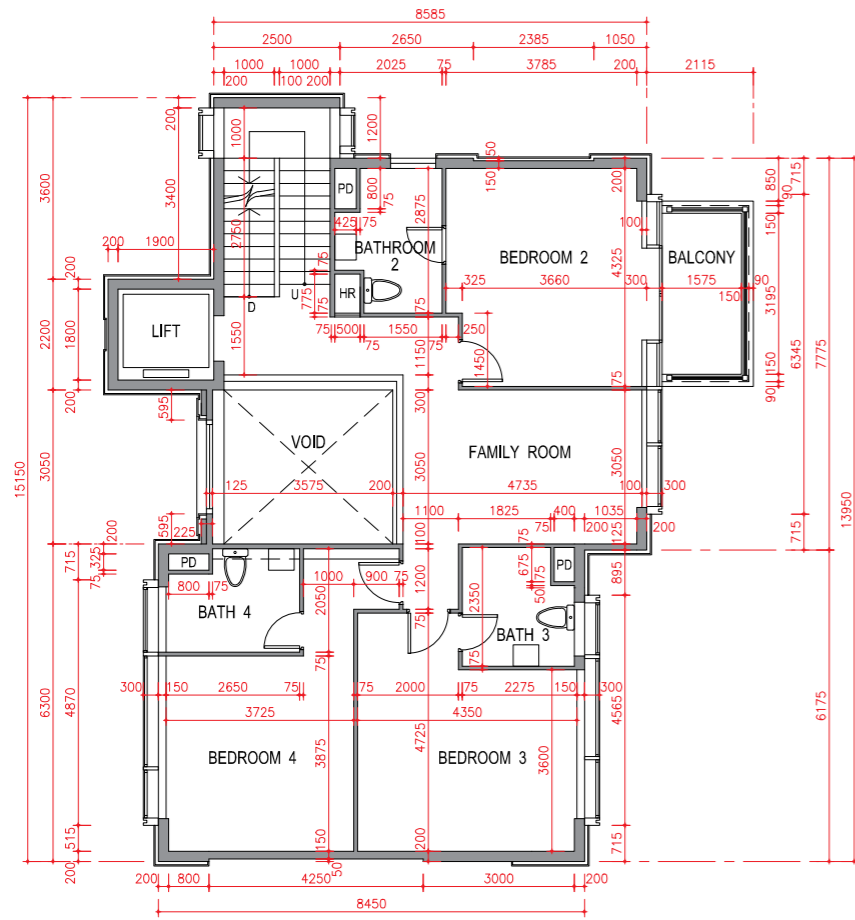
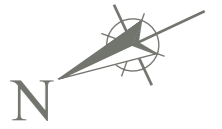

0M / 米 5M / 米
Scale:
比例:

AREA OF RESIDENTIAL PROPERTIES IN THE DEVELOPMENT
發展項目的住宅物業的面積

Description of Residential Property 物業的描述			Saleable Area (Including balcony, utility platform and verandah, if any) sq. meter (sq. ft.) 實用面積 (包括露台、工作平台及陽台 (如有)) 平方米 (平方呎)	Area of other specified items (Not included in the Saleable Area) 其他指明項目的面積 (不計算入實用面積) sq. meter (sq. ft.) 平方米 (平方呎)									
Multi-unit building 多單位建築物	Floor 樓層	Flat 單位		Air-conditioning plant room 空調機房	Bay Window 窗台	Cockloft 閣樓	Flat Roof 平台	Garden 花園	Parking Space 停車位	Roof 天台	Stairhood 梯屋	Terrace 前庭	Yard 庭院
DOMUS 尚築	G/F 地下	1	25.661 (276) Balcony 露台: - (-) Utility Platform 工作平台: - (-) Verandah 陽台: - (-)	-	-	-	-	16.880 (182)	-	-	-	-	-
		2	19.348 (208) Balcony 露台: - (-) Utility Platform 工作平台: - (-) Verandah 陽台: - (-)	-	-	-	-	10.165 (109)	-	-	-	-	-
		3	23.169 (249) Balcony 露台: - (-) Utility Platform 工作平台: - (-) Verandah 陽台: - (-)	-	-	-	-	12.930 (139)	-	-	-	-	-
		5	20.384 (219) Balcony 露台: - (-) Utility Platform 工作平台: - (-) Verandah 陽台: - (-)	-	-	-	-	6.634 (71)	-	-	-	-	-
		6	20.384 (219) Balcony 露台: - (-) Utility Platform 工作平台: - (-) Verandah 陽台: - (-)	-	-	-	-	7.336 (79)	-	-	-	-	-
		7	20.384 (219) Balcony 露台: - (-) Utility Platform 工作平台: - (-) Verandah 陽台: - (-)	-	-	-	-	8.040 (87)	-	-	-	-	-
		8	20.384 (219) Balcony 露台: - (-) Utility Platform 工作平台: - (-) Verandah 陽台: - (-)	-	-	-	-	8.742 (94)	-	-	-	-	-
		9	20.384 (219) Balcony 露台: - (-) Utility Platform 工作平台: - (-) Verandah 陽台: - (-)	-	-	-	-	9.447 (102)	-	-	-	-	-
		10	20.384 (219) Balcony 露台: - (-) Utility Platform 工作平台: - (-) Verandah 陽台: - (-)	-	-	-	-	10.148 (109)	-	-	-	-	-

- The saleable area of each residential property and the floor areas of every balcony, utility platform or verandah (if any) to the extent that it forms parts of the residential property are calculated in accordance with section 8 of the Residential Properties (First-hand Sales) Ordinance.
- The area of every air-conditioning plant room, bay window, cockloft, flat roof, garden, parking space, roof, stairhood, terrace or yard (if any) to the extent that it forms parts of the residential property is calculated in accordance with Part 2 of Schedule 2 to the Residential Properties (First-hand Sales) Ordinance.

Notes:

- The areas as specified above in square metre are converted into square feet at a rate of 1 square metre = 10.764 square feet and rounded off to the nearest whole square foot.
- There is no verandah in the residential properties of the Development.

- 每個住宅物業的實用面積，以及構成住宅物業的一部分的範圍內的每一個露台、工作平台或陽台(如有的話)的樓面面積，是按照《一手住宅物業銷售條例》第8條計算得出的。
- 構成住宅物業的一部分的範圍內的每一空調機房、窗台、閣樓、平台、花園、停車位、天台、梯屋、前庭或庭院(如有的話)的面積，是按照《一手住宅物業銷售條例》附表2第2部計算得出的。

備註:

- 上述所列以平方米列明之面積，均以1平方米=10.764平方呎換算至平方呎，並四捨五入至整數平方呎。
- 發展項目的住宅物業不設陽台。

AREA OF RESIDENTIAL PROPERTIES IN THE DEVELOPMENT
發展項目的住宅物業的面積

Description of Residential Property 物業的描述			Saleable Area (Including balcony, utility platform and verandah, if any) sq. meter (sq. ft.) 實用面積 (包括露台, 工作平台及陽台 (如有)) 平方米 (平方呎)	Area of other specified items (Not included in the Saleable Area) 其他指明項目的面積 (不計算入實用面積) sq. meter (sq. ft.) 平方米 (平方呎)									
Multi-unit building 多單位建築物	Floor 樓層	Flat 單位		Air-conditioning plant room 空調機房	Bay Window 窗台	Cockloft 閣樓	Flat Roof 平台	Garden 花園	Parking Space 停車位	Roof 天台	Stairhood 梯屋	Terrace 前庭	Yard 庭院
DOMUS 尚築	G/F 地下	11	Balcony 露台: 20.384 (219) Utility Platform 工作平台: - (-) Verandah 陽台: - (-)	-	-	-	-	10.853 (117)	-	-	-	-	-
		12	Balcony 露台: 20.350 (219) Utility Platform 工作平台: - (-) Verandah 陽台: - (-)	-	-	-	-	13.311 (143)	-	-	-	-	-
		15	Balcony 露台: 17.758 (191) Utility Platform 工作平台: - (-) Verandah 陽台: - (-)	-	-	-	-	6.629 (71)	-	-	-	-	-
		16	Balcony 露台: 20.498 (221) Utility Platform 工作平台: - (-) Verandah 陽台: - (-)	-	-	-	-	6.289 (68)	-	-	-	-	-
		17	Balcony 露台: 20.384 (219) Utility Platform 工作平台: - (-) Verandah 陽台: - (-)	-	-	-	-	6.289 (68)	-	-	-	-	-
		18	Balcony 露台: 20.384 (219) Utility Platform 工作平台: - (-) Verandah 陽台: - (-)	-	-	-	-	6.289 (68)	-	-	-	-	-
		19	Balcony 露台: 20.384 (219) Utility Platform 工作平台: - (-) Verandah 陽台: - (-)	-	-	-	-	6.289 (68)	-	-	-	-	-
		20	Balcony 露台: 20.384 (219) Utility Platform 工作平台: - (-) Verandah 陽台: - (-)	-	-	-	-	6.289 (68)	-	-	-	-	-
		21	Balcony 露台: 20.384 (219) Utility Platform 工作平台: - (-) Verandah 陽台: - (-)	-	-	-	-	7.147 (77)	-	-	-	-	-

- The saleable area of each residential property and the floor areas of every balcony, utility platform or verandah (if any) to the extent that it forms parts of the residential property are calculated in accordance with section 8 of the Residential Properties (First-hand Sales) Ordinance.
- The area of every air-conditioning plant room, bay window, cockloft, flat roof, garden, parking space, roof, stairhood, terrace or yard (if any) to the extent that it forms parts of the residential property is calculated in accordance with Part 2 of Schedule 2 to the Residential Properties (First-hand Sales) Ordinance.

Notes:

- The areas as specified above in square metre are converted into square feet at a rate of 1 square metre = 10.764 square feet and rounded off to the nearest whole square foot.
- There is no verandah in the residential properties of the Development.

- 每個住宅物業的實用面積，以及構成住宅物業的一部分的範圍內的每一個露台、工作平台或陽台(如有的話)的樓面面積，是按照《一手住宅物業銷售條例》第8條計算得出的。
- 構成住宅物業的一部分的範圍內的每一空調機房、窗台、閣樓、平台、花園、停車位、天台、梯屋、前庭或庭院(如有的話)的面積，是按照《一手住宅物業銷售條例》附表2第2部計算得出的。

備註:

- 上述所列以平方米列明之面積，均以1平方米=10.764平方呎換算至平方呎，並四捨五入至整數平方呎。
- 發展項目的住宅物業不設陽台。

AREA OF RESIDENTIAL PROPERTIES IN THE DEVELOPMENT
發展項目的住宅物業的面積

Description of Residential Property 物業的描述			Saleable Area (Including balcony, utility platform and verandah, if any) sq. meter (sq. ft.) 實用面積 (包括露台、工作平台及陽台 (如有)) 平方米 (平方呎)	Area of other specified items (Not included in the Saleable Area) 其他指明項目的面積 (不計算入實用面積) sq. meter (sq. ft.) 平方米 (平方呎)									
Multi-unit building 多單位建築物	Floor 樓層	Flat 單位		Air-conditioning plant room 空調機房	Bay Window 窗台	Cockloft 閣樓	Flat Roof 平台	Garden 花園	Parking Space 停車位	Roof 天台	Stairhood 梯屋	Terrace 前庭	Yard 庭院
DOMUS 尚築	G/F 地下	22	21.209 (228) Balcony 露台: - (-) Utility Platform 工作平台: - (-) Verandah 陽台: - (-)	-	-	-	-	8.204 (88)	-	-	-	-	-
		23	20.761 (223) Balcony 露台: - (-) Utility Platform 工作平台: - (-) Verandah 陽台: - (-)	-	-	-	-	8.547 (92)	-	-	-	-	-
		25	20.384 (219) Balcony 露台: - (-) Utility Platform 工作平台: - (-) Verandah 陽台: - (-)	-	-	-	-	8.589 (92)	-	-	-	-	-
		26	20.862 (225) Balcony 露台: - (-) Utility Platform 工作平台: - (-) Verandah 陽台: - (-)	-	-	-	-	7.313 (79)	-	-	-	-	-
		27	21.053 (227) Balcony 露台: - (-) Utility Platform 工作平台: - (-) Verandah 陽台: - (-)	-	-	-	-	6.867 (74)	-	-	-	-	-
		28	20.498 (221) Balcony 露台: - (-) Utility Platform 工作平台: - (-) Verandah 陽台: - (-)	-	-	-	-	8.595 (93)	-	-	-	-	-
		29	17.758 (191) Balcony 露台: - (-) Utility Platform 工作平台: - (-) Verandah 陽台: - (-)	-	-	-	-	10.630 (114)	-	-	-	-	-
		30	20.350 (219) Balcony 露台: - (-) Utility Platform 工作平台: - (-) Verandah 陽台: - (-)	-	-	-	-	13.857 (149)	-	-	-	-	-
		31	20.384 (219) Balcony 露台: - (-) Utility Platform 工作平台: - (-) Verandah 陽台: - (-)	-	-	-	-	11.109 (120)	-	-	-	-	-

- The saleable area of each residential property and the floor areas of every balcony, utility platform or verandah (if any) to the extent that it forms parts of the residential property are calculated in accordance with section 8 of the Residential Properties (First-hand Sales) Ordinance.
- The area of every air-conditioning plant room, bay window, cockloft, flat roof, garden, parking space, roof, stairhood, terrace or yard (if any) to the extent that it forms parts of the residential property is calculated in accordance with Part 2 of Schedule 2 to the Residential Properties (First-hand Sales) Ordinance.

Notes:

- The areas as specified above in square metre are converted into square feet at a rate of 1 square metre = 10.764 square feet and rounded off to the nearest whole square foot.
- There is no verandah in the residential properties of the Development.

- 每個住宅物業的實用面積，以及構成住宅物業的一部分的範圍內的每一個露台、工作平台或陽台(如有的話)的樓面面積，是按照《一手住宅物業銷售條例》第8條計算得出的。
- 構成住宅物業的一部分的範圍內的每一空調機房、窗台、閣樓、平台、花園、停車位、天台、梯屋、前庭或庭院(如有的話)的面積，是按照《一手住宅物業銷售條例》附表2第2部計算得出的。

備註:

- 上述所列以平方米列明之面積，均以1平方米=10.764平方呎換算至平方呎，並四捨五入至整數平方呎。
- 發展項目的住宅物業不設陽台。

AREA OF RESIDENTIAL PROPERTIES IN THE DEVELOPMENT
發展項目的住宅物業的面積

Description of Residential Property 物業的描述			Saleable Area (Including balcony, utility platform and verandah, if any) sq. meter (sq. ft.) 實用面積 (包括露台, 工作平台及陽台 (如有)) 平方米 (平方呎)	Area of other specified items (Not included in the Saleable Area) 其他指明項目的面積 (不計算入實用面積) sq. meter (sq. ft.) 平方米 (平方呎)									
Multi-unit building 多單位建築物	Floor 樓層	Flat 單位		Air-conditioning plant room 空調機房	Bay Window 窗台	Cockloft 閣樓	Flat Roof 平台	Garden 花園	Parking Space 停車位	Roof 天台	Stairhood 梯屋	Terrace 前庭	Yard 庭院
DOMUS 尚築	G/F 地下	32	Balcony 露台: 20.384 (219) Utility Platform 工作平台: - (-) Verandah 陽台: - (-)	-	-	-	-	11.109 (120)	-	-	-	-	-
		33	Balcony 露台: 20.275 (218) Utility Platform 工作平台: - (-) Verandah 陽台: - (-)	-	-	-	-	10.128 (109)	-	-	-	-	-
		35	Balcony 露台: 20.987 (226) Utility Platform 工作平台: - (-) Verandah 陽台: - (-)	-	-	-	-	12.703 (137)	-	-	-	-	-
		36	Balcony 露台: 20.384 (219) Utility Platform 工作平台: - (-) Verandah 陽台: - (-)	-	-	-	-	13.232 (142)	-	-	-	-	-
		37	Balcony 露台: 20.384 (219) Utility Platform 工作平台: - (-) Verandah 陽台: - (-)	-	-	-	-	13.793 (148)	-	-	-	-	-
		38	Balcony 露台: 20.841 (224) Utility Platform 工作平台: - (-) Verandah 陽台: - (-)	-	-	-	-	13.938 (150)	-	-	-	-	-

- The saleable area of each residential property and the floor areas of every balcony, utility platform or verandah (if any) to the extent that it forms parts of the residential property are calculated in accordance with section 8 of the Residential Properties (First-hand Sales) Ordinance.
- The area of every air-conditioning plant room, bay window, cockloft, flat roof, garden, parking space, roof, stairhood, terrace or yard (if any) to the extent that it forms parts of the residential property is calculated in accordance with Part 2 of Schedule 2 to the Residential Properties (First-hand Sales) Ordinance.

Notes:

- The areas as specified above in square metre are converted into square feet at a rate of 1 square metre = 10.764 square feet and rounded off to the nearest whole square foot.
- There is no verandah in the residential properties of the Development.

- 每個住宅物業的實用面積，以及構成住宅物業的一部分的範圍內的每一個露台、工作平台或陽台(如有的話)的樓面面積，是按照《一手住宅物業銷售條例》第8條計算得出的。
- 構成住宅物業的一部分的範圍內的每一空調機房、窗台、閣樓、平台、花園、停車位、天台、梯屋、前庭或庭院(如有的話)的面積，是按照《一手住宅物業銷售條例》附表2第2部計算得出的。

備註：

- 上述所列以平方米列明之面積，均以1平方米=10.764平方呎換算至平方呎，並四捨五入至整數平方呎。
- 發展項目的住宅物業不設陽台。

AREA OF RESIDENTIAL PROPERTIES IN THE DEVELOPMENT
發展項目的住宅物業的面積

Description of Residential Property 物業的描述			Saleable Area (Including balcony, utility platform and verandah, if any) sq. meter (sq. ft.) 實用面積 (包括露台, 工作平台及陽台 (如有)) 平方米 (平方呎)	Area of other specified items (Not included in the Saleable Area) 其他指明項目的面積 (不計算入實用面積) sq. meter (sq. ft.) 平方米 (平方呎)								
Multi-unit building 多單位建築物	Floor 樓層	Flat 單位		Air-conditioning plant room 空調機房	Bay Window 窗台	Cockloft 閣樓	Flat Roof 平台	Garden 花園	Parking Space 停車位	Roof 天台	Stairhood 梯屋	Terrace 前庭
DOMUS 尚築	1/F - 3/F 一樓 至 三樓	1	22.566 (243) Balcony 露台: 2.005 (22) Utility Platform 工作平台: - (-) Verandah 陽台: - (-)	-	-	-	-	-	-	-	-	-
		2	22.566 (243) Balcony 露台: 2.005 (22) Utility Platform 工作平台: - (-) Verandah 陽台: - (-)	-	-	-	-	-	-	-	-	-
		3	21.553 (232) Balcony 露台: 2.103 (23) Utility Platform 工作平台: - (-) Verandah 陽台: - (-)	-	-	-	-	-	-	-	-	-
		5	25.404 (273) Balcony 露台: 2.093 (23) Utility Platform 工作平台: - (-) Verandah 陽台: - (-)	-	-	-	-	-	-	-	-	-
		6	22.566 (243) Balcony 露台: 2.005 (22) Utility Platform 工作平台: - (-) Verandah 陽台: - (-)	-	-	-	-	-	-	-	-	-
		7	22.566 (243) Balcony 露台: 2.005 (22) Utility Platform 工作平台: - (-) Verandah 陽台: - (-)	-	-	-	-	-	-	-	-	-
		8	22.566 (243) Balcony 露台: 2.005 (22) Utility Platform 工作平台: - (-) Verandah 陽台: - (-)	-	-	-	-	-	-	-	-	-
		9	22.566 (243) Balcony 露台: 2.005 (22) Utility Platform 工作平台: - (-) Verandah 陽台: - (-)	-	-	-	-	-	-	-	-	-
		10	22.566 (243) Balcony 露台: 2.005 (22) Utility Platform 工作平台: - (-) Verandah 陽台: - (-)	-	-	-	-	-	-	-	-	-

- The saleable area of each residential property and the floor areas of every balcony, utility platform or verandah (if any) to the extent that it forms parts of the residential property are calculated in accordance with section 8 of the Residential Properties (First-hand Sales) Ordinance.
- The area of every air-conditioning plant room, bay window, cockloft, flat roof, garden, parking space, roof, stairhood, terrace or yard (if any) to the extent that it forms parts of the residential property is calculated in accordance with Part 2 of Schedule 2 to the Residential Properties (First-hand Sales) Ordinance.

Notes:

- The areas as specified above in square metre are converted into square feet at a rate of 1 square metre = 10.764 square feet and rounded off to the nearest whole square foot.
- There is no verandah in the residential properties of the Development.

- 每個住宅物業的實用面積, 以及構成住宅物業的一部分的範圍內的每一個露台、工作平台或陽台(如有的話)的樓面面積, 是按照《一手住宅物業銷售條例》第8條計算得出的。
- 構成住宅物業的一部分的範圍內的每一空調機房、窗台、閣樓、平台、花園、停車位、天台、梯屋、前庭或庭院(如有的話)的面積, 是按照《一手住宅物業銷售條例》附表2第2部計算得出的。

備註:

- 上述所列以平方米列明之面積, 均以1平方米=10.764平方呎換算至平方呎, 並四捨五入至整數平方呎。
- 發展項目的住宅物業不設陽台。

Description of Residential Property 物業的描述			Saleable Area (Including balcony, utility platform and verandah, if any) sq. meter (sq. ft.) 實用面積 (包括露台, 工作平台及陽台 (如有)) 平方米 (平方呎)	Area of other specified items (Not included in the Saleable Area) 其他指明項目的面積 (不計算入實用面積) sq. meter (sq. ft.) 平方米 (平方呎)								
Multi-unit building 多單位建築物	Floor 樓層	Flat 單位		Air-conditioning plant room 空調機房	Bay Window 窗台	Cockloft 閣樓	Flat Roof 平台	Garden 花園	Parking Space 停車位	Roof 天台	Stairhood 梯屋	Terrace 前庭
DOMUS 尚築	1/F - 3/F 一樓 至 三樓	11	22.566 (243) Balcony 露台: 2.005 (22) Utility Platform 工作平台: - (-) Verandah 陽台: - (-)	-	-	-	-	-	-	-	-	-
		12	22.566 (243) Balcony 露台: 2.005 (22) Utility Platform 工作平台: - (-) Verandah 陽台: - (-)	-	-	-	-	-	-	-	-	-
		15	22.911 (247) Balcony 露台: 2.005 (22) Utility Platform 工作平台: - (-) Verandah 陽台: - (-)	-	-	-	-	-	-	-	-	-
		16	20.319 (219) Balcony 露台: 2.005 (22) Utility Platform 工作平台: - (-) Verandah 陽台: - (-)	-	-	-	-	-	-	-	-	-
		17	22.680 (244) Balcony 露台: 2.005 (22) Utility Platform 工作平台: - (-) Verandah 陽台: - (-)	-	-	-	-	-	-	-	-	-
		18	22.566 (243) Balcony 露台: 2.005 (22) Utility Platform 工作平台: - (-) Verandah 陽台: - (-)	-	-	-	-	-	-	-	-	-
		19	22.566 (243) Balcony 露台: 2.005 (22) Utility Platform 工作平台: - (-) Verandah 陽台: - (-)	-	-	-	-	-	-	-	-	-
		20	22.566 (243) Balcony 露台: 2.005 (22) Utility Platform 工作平台: - (-) Verandah 陽台: - (-)	-	-	-	-	-	-	-	-	-
		21	22.566 (243) Balcony 露台: 2.005 (22) Utility Platform 工作平台: - (-) Verandah 陽台: - (-)	-	-	-	-	-	-	-	-	-

- The saleable area of each residential property and the floor areas of every balcony, utility platform or verandah (if any) to the extent that it forms parts of the residential property are calculated in accordance with section 8 of the Residential Properties (First-hand Sales) Ordinance.
- The area of every air-conditioning plant room, bay window, cockloft, flat roof, garden, parking space, roof, stairhood, terrace or yard (if any) to the extent that it forms parts of the residential property is calculated in accordance with Part 2 of Schedule 2 to the Residential Properties (First-hand Sales) Ordinance.

Notes:

- The areas as specified above in square metre are converted into square feet at a rate of 1 square metre = 10.764 square feet and rounded off to the nearest whole square foot.
- There is no verandah in the residential properties of the Development.

- 每個住宅物業的實用面積，以及構成住宅物業的一部分的範圍內的每一個露台、工作平台或陽台(如有的話)的樓面面積，是按照《一手住宅物業銷售條例》第8條計算得出的。
- 構成住宅物業的一部分的範圍內的每一空調機房、窗台、閣樓、平台、花園、停車位、天台、梯屋、前庭或庭院(如有的話)的面積，是按照《一手住宅物業銷售條例》附表2第2部計算得出的。

備註:

- 上述所列以平方米列明之面積，均以1平方米=10.764平方呎換算至平方呎，並四捨五入至整數平方呎。
- 發展項目的住宅物業不設陽台。

AREA OF RESIDENTIAL PROPERTIES IN THE DEVELOPMENT
發展項目的住宅物業的面積

Description of Residential Property 物業的描述			Saleable Area (Including balcony, utility platform and verandah, if any) sq. meter (sq. ft.) 實用面積 (包括露台, 工作平台及陽台 (如有)) 平方米 (平方呎)	Area of other specified items (Not included in the Saleable Area) 其他指明項目的面積 (不計算入實用面積) sq. meter (sq. ft.) 平方米 (平方呎)								
Multi-unit building 多單位建築物	Floor 樓層	Flat 單位		Air-conditioning plant room 空調機房	Bay Window 窗台	Cockloft 閣樓	Flat Roof 平台	Garden 花園	Parking Space 停車位	Roof 天台	Stairhood 梯屋	Terrace 前庭
DOMUS 尚築	1/F - 3/F 一樓 至 三樓	22	22.566 (243) Balcony 露台: 2.005 (22) Utility Platform 工作平台: - (-) Verandah 陽台: - (-)	-	-	-	-	-	-	-	-	-
		23	23.274 (251) Balcony 露台: 2.005 (22) Utility Platform 工作平台: - (-) Verandah 陽台: - (-)	-	-	-	-	-	-	-	-	-
		25	25.846 (278) Balcony 露台: 2.103 (23) Utility Platform 工作平台: - (-) Verandah 陽台: - (-)	-	-	-	-	-	-	-	-	-
		26	22.566 (243) Balcony 露台: 2.005 (22) Utility Platform 工作平台: - (-) Verandah 陽台: - (-)	-	-	-	-	-	-	-	-	-
		27	22.700 (244) Balcony 露台: 2.005 (22) Utility Platform 工作平台: - (-) Verandah 陽台: - (-)	-	-	-	-	-	-	-	-	-
		28	22.697 (244) Balcony 露台: 1.735 (19) Utility Platform 工作平台: - (-) Verandah 陽台: - (-)	-	-	-	-	-	-	-	-	-
		31	22.543 (243) Balcony 露台: 2.005 (22) Utility Platform 工作平台: - (-) Verandah 陽台: - (-)	-	-	-	-	-	-	-	-	-
		32	22.566 (243) Balcony 露台: 2.005 (22) Utility Platform 工作平台: - (-) Verandah 陽台: - (-)	-	-	-	-	-	-	-	-	-
		33	22.566 (243) Balcony 露台: 2.005 (22) Utility Platform 工作平台: - (-) Verandah 陽台: - (-)	-	-	-	-	-	-	-	-	-

- The saleable area of each residential property and the floor areas of every balcony, utility platform or verandah (if any) to the extent that it forms parts of the residential property are calculated in accordance with section 8 of the Residential Properties (First-hand Sales) Ordinance.
- The area of every air-conditioning plant room, bay window, cockloft, flat roof, garden, parking space, roof, stairhood, terrace or yard (if any) to the extent that it forms parts of the residential property is calculated in accordance with Part 2 of Schedule 2 to the Residential Properties (First-hand Sales) Ordinance.

Notes:

- The areas as specified above in square metre are converted into square feet at a rate of 1 square metre = 10.764 square feet and rounded off to the nearest whole square foot.
- There is no verandah in the residential properties of the Development.

- 每個住宅物業的實用面積, 以及構成住宅物業的一部分的範圍內的每一個露台、工作平台或陽台(如有的話)的樓面面積, 是按照《一手住宅物業銷售條例》第8條計算得出的。
- 構成住宅物業的一部分的範圍內的每一空調機房、窗台、閣樓、平台、花園、停車位、天台、梯屋、前庭或庭院(如有的話)的面積, 是按照《一手住宅物業銷售條例》附表2第2部計算得出的。

備註:

- 上述所列以平方米列明之面積, 均以1平方米=10.764平方呎換算至平方呎, 並四捨五入至整數平方呎。
- 發展項目的住宅物業不設陽台。

Description of Residential Property 物業的描述			Saleable Area (Including balcony, utility platform and verandah, if any) sq. meter (sq. ft.) 實用面積 (包括露台, 工作平台及陽台 (如有)) 平方米 (平方呎)	Area of other specified items (Not included in the Saleable Area) 其他指明項目的面積 (不計算入實用面積) sq. meter (sq. ft.) 平方米 (平方呎)									
Multi-unit building 多單位建築物	Floor 樓層	Flat 單位		Air-conditioning plant room 空調機房	Bay Window 窗台	Cockloft 閣樓	Flat Roof 平台	Garden 花園	Parking Space 停車位	Roof 天台	Stairhood 梯屋	Terrace 前庭	Yard 庭院
DOMUS 尚築	1/F - 3/F 一樓 至 三樓	35	22.843 (246) Balcony 露台: 2.005 (22) Utility Platform 工作平台: - (-) Verandah 陽台: - (-)	-	-	-	-	-	-	-	-	-	
		36	23.555 (254) Balcony 露台: 2.005 (22) Utility Platform 工作平台: - (-) Verandah 陽台: - (-)	-	-	-	-	-	-	-	-	-	
		37	22.566 (243) Balcony 露台: 2.005 (22) Utility Platform 工作平台: - (-) Verandah 陽台: - (-)	-	-	-	-	-	-	-	-	-	
		38	22.566 (243) Balcony 露台: 2.005 (22) Utility Platform 工作平台: - (-) Verandah 陽台: - (-)	-	-	-	-	-	-	-	-	-	
		39	22.566 (243) Balcony 露台: 2.005 (22) Utility Platform 工作平台: - (-) Verandah 陽台: - (-)	-	-	-	-	-	-	-	-	-	
	1/F - 2/F 一樓 至 二樓	29	22.680 (244) Balcony 露台: 2.005 (22) Utility Platform 工作平台: - (-) Verandah 陽台: - (-)	-	-	-	-	-	-	-	-	-	-
		30	19.951 (215) Balcony 露台: 2.005 (22) Utility Platform 工作平台: - (-) Verandah 陽台: - (-)	-	-	-	-	-	-	-	-	-	-
	3/F 三樓	30	42.632 (459) Balcony 露台: 4.011 (43) Utility Platform 工作平台: - (-) Verandah 陽台: - (-)	-	-	-	-	-	-	-	-	-	-

- The saleable area of each residential property and the floor areas of every balcony, utility platform or verandah (if any) to the extent that it forms parts of the residential property are calculated in accordance with section 8 of the Residential Properties (First-hand Sales) Ordinance.
- The area of every air-conditioning plant room, bay window, cockloft, flat roof, garden, parking space, roof, stairhood, terrace or yard (if any) to the extent that it forms parts of the residential property is calculated in accordance with Part 2 of Schedule 2 to the Residential Properties (First-hand Sales) Ordinance.

Notes:

- The areas as specified above in square metre are converted into square feet at a rate of 1 square metre = 10.764 square feet and rounded off to the nearest whole square foot.
- There is no verandah in the residential properties of the Development.

- 每個住宅物業的實用面積，以及構成住宅物業的一部分的範圍內的每一個露台、工作平台或陽台(如有的話)的樓面面積，是按照《一手住宅物業銷售條例》第8條計算得出的。
- 構成住宅物業的一部分的範圍內的每一空調機房、窗台、閣樓、平台、花園、停車位、天台、梯屋、前庭或庭院(如有的話)的面積，是按照《一手住宅物業銷售條例》附表2第2部計算得出的。

備註:

- 上述所列以平方米列明之面積，均以1平方米=10.764平方呎換算至平方呎，並四捨五入至整數平方呎。
- 發展項目的住宅物業不設陽台。

AREA OF RESIDENTIAL PROPERTIES IN THE DEVELOPMENT
發展項目的住宅物業的面積

Description of Residential Property 物業的描述	Saleable Area (Including balcony, utility platform and verandah, if any) sq. meter (sq. ft.) 實用面積 (包括露台, 工作平台及陽台 (如有)) 平方米 (平方呎)	Area of other specified items (Not included in the Saleable Area) 其他指明項目的面積 (不計算入實用面積) sq. meter (sq. ft.) 平方米 (平方呎)									
		Air-conditioning plant room 空調機房	Bay Window 窗台	Cockloft 閣樓	Flat Roof 平台	Garden 花園	Parking Space 停車位	Roof 天台	Stairhood 梯屋	Terrace 前庭	Yard 庭院
67A Tan Kwai Tsuen Road, Casa Regalia 富豪·悅庭丹桂村路 67A 號	262.801 (2829) Balcony 露台: 4.500 (48) Utility Platform 工作平台: - (-) Verandah 陽台: - (-)	-	-	-	13.052 (140)	61.338 (660)	-	51.569 (555)	6.864 (74)	-	-
67B Tan Kwai Tsuen Road, Casa Regalia 富豪·悅庭丹桂村路 67B 號	262.361 (2824) Balcony 露台: 4.500 (48) Utility Platform 工作平台: - (-) Verandah 陽台: - (-)	-	-	-	13.052 (140)	83.243 (896)	-	51.569 (555)	6.864 (74)	-	-
69A Tan Kwai Tsuen Road, Casa Regalia 富豪·悅庭丹桂村路 69A 號	262.361 (2824) Balcony 露台: 4.500 (48) Utility Platform 工作平台: - (-) Verandah 陽台: - (-)	-	-	-	13.052 (140)	80.902 (871)	-	51.569 (555)	6.864 (74)	-	-
69B Tan Kwai Tsuen Road, Casa Regalia 富豪·悅庭丹桂村路 69B 號	262.399 (2824) Balcony 露台: 4.500 (48) Utility Platform 工作平台: - (-) Verandah 陽台: - (-)	-	-	-	13.052 (140)	81.619 (879)	-	51.569 (555)	6.864 (74)	-	-
71A Tan Kwai Tsuen Road, Casa Regalia 富豪·悅庭丹桂村路 71A 號	257.671 (2774) Balcony 露台: 4.500 (48) Utility Platform 工作平台: - (-) Verandah 陽台: - (-)	-	-	-	6.278 (68)	88.180 (949)	-	52.433 (564)	6.843 (74)	-	-
71B Tan Kwai Tsuen Road, Casa Regalia 富豪·悅庭丹桂村路 71B 號	257.978 (2777) Balcony 露台: 4.500 (48) Utility Platform 工作平台: - (-) Verandah 陽台: - (-)	-	-	-	6.278 (68)	84.682 (912)	-	52.433 (564)	6.843 (74)	-	-
73A Tan Kwai Tsuen Road, Casa Regalia 富豪·悅庭丹桂村路 73A 號	257.643 (2773) Balcony 露台: 4.500 (48) Utility Platform 工作平台: - (-) Verandah 陽台: - (-)	-	-	-	6.278 (68)	78.524 (845)	-	52.433 (564)	6.843 (74)	-	-
73B Tan Kwai Tsuen Road, Casa Regalia 富豪·悅庭丹桂村路 73B 號	257.553 (2772) Balcony 露台: 4.500 (48) Utility Platform 工作平台: - (-) Verandah 陽台: - (-)	-	-	-	6.278 (68)	72.793 (784)	-	52.433 (564)	6.843 (74)	-	-
75A Tan Kwai Tsuen Road, Casa Regalia 富豪·悅庭丹桂村路 75A 號	221.652 (2386) Balcony 露台: 3.718 (40) Utility Platform 工作平台: - (-) Verandah 陽台: - (-)	-	-	-	15.019 (162)	73.923 (796)	-	35.755 (385)	6.862 (74)	-	-

- The saleable area of each residential property and the floor areas of every balcony, utility platform or verandah (if any) to the extent that it forms parts of the residential property are calculated in accordance with section 8 of the Residential Properties (First-hand Sales) Ordinance.
- The area of every air-conditioning plant room, bay window, cockloft, flat roof, garden, parking space, roof, stairhood, terrace or yard (if any) to the extent that it forms parts of the residential property is calculated in accordance with Part 2 of Schedule 2 to the Residential Properties (First-hand Sales) Ordinance.

Notes:

- The areas as specified above in square metre are converted into square feet at a rate of 1 square metre = 10.764 square feet and rounded off to the nearest whole square foot.
- There is no verandah in the residential properties of the Development.

- 每個住宅物業的實用面積, 以及構成住宅物業的一部分的範圍內的每一個露台、工作平台或陽台 (如有的話) 的樓面面積, 是按照《一手住宅物業銷售條例》第8條計算得出的。
- 構成住宅物業的一部分的範圍內的每一空調機房、窗台、閣樓、平台、花園、停車位、天台、梯屋、前庭或庭院 (如有的話) 的面積, 是按照《一手住宅物業銷售條例》附表2第2部計算得出的。

備註:

- 上述所列以平方米列明之面積, 均以1平方米=10.764平方呎換算至平方呎, 並四捨五入至整數平方呎。
- 發展項目的住宅物業不設陽台。

AREA OF RESIDENTIAL PROPERTIES IN THE DEVELOPMENT
發展項目的住宅物業的面積

Description of Residential Property 物業的描述	Saleable Area (Including balcony, utility platform and verandah, if any) sq. meter (sq. ft.) 實用面積 (包括露台, 工作平台及陽台 (如有)) 平方米 (平方呎)	Area of other specified items (Not included in the Saleable Area) 其他指明項目的面積 (不計算入實用面積) sq. meter (sq. ft.) 平方米 (平方呎)									
		Air-conditioning plant room 空調機房	Bay Window 窗台	Cockloft 閣樓	Flat Roof 平台	Garden 花園	Parking Space 停車位	Roof 天台	Stairhood 梯屋	Terrace 前庭	Yard 庭院
75B Tan Kwai Tsuen Road, Casa Regalia 富豪·悅庭丹桂村路 75B 號	221.622 (2386) Balcony 露台: 3.718 (40) Utility Platform 工作平台: - (-) Verandah 陽台: - (-)	-	-	-	15.019 (162)	68.821 (741)	-	35.755 (385)	6.862 (74)	-	-
77A Tan Kwai Tsuen Road, Casa Regalia 富豪·悅庭丹桂村路 77A 號	221.672 (2386) Balcony 露台: 3.718 (40) Utility Platform 工作平台: - (-) Verandah 陽台: - (-)	-	-	-	15.019 (162)	60.935 (656)	-	35.755 (385)	6.862 (74)	-	-
77B Tan Kwai Tsuen Road, Casa Regalia 富豪·悅庭丹桂村路 77B 號	221.987 (2389) Balcony 露台: 3.718 (40) Utility Platform 工作平台: - (-) Verandah 陽台: - (-)	-	-	-	15.019 (162)	54.019 (581)	-	35.755 (385)	6.862 (74)	-	-
79A Tan Kwai Tsuen Road, Casa Regalia 富豪·悅庭丹桂村路 79A 號	199.785 (2150) Balcony 露台: 3.718 (40) Utility Platform 工作平台: - (-) Verandah 陽台: - (-)	-	-	-	13.368 (144)	48.645 (524)	-	31.465 (339)	6.716 (72)	-	-
79B Tan Kwai Tsuen Road, Casa Regalia 富豪·悅庭丹桂村路 79B 號	199.784 (2150) Balcony 露台: 3.718 (40) Utility Platform 工作平台: - (-) Verandah 陽台: - (-)	-	-	-	13.368 (144)	18.733 (202)	-	31.465 (339)	6.716 (72)	-	-
79C Tan Kwai Tsuen Road, Casa Regalia 富豪·悅庭丹桂村路 79C 號	199.944 (2152) Balcony 露台: 3.718 (40) Utility Platform 工作平台: - (-) Verandah 陽台: - (-)	-	-	-	13.368 (144)	35.515 (382)	-	31.465 (339)	6.716 (72)	-	-
79D Tan Kwai Tsuen Road, Casa Regalia 富豪·悅庭丹桂村路 79D 號	200.817 (2162) Balcony 露台: 3.718 (40) Utility Platform 工作平台: - (-) Verandah 陽台: - (-)	-	-	-	13.368 (144)	16.021 (172)	-	31.465 (339)	6.716 (72)	-	-
79E Tan Kwai Tsuen Road, Casa Regalia 富豪·悅庭丹桂村路 79E 號	198.435 (2136) Balcony 露台: 3.718 (40) Utility Platform 工作平台: - (-) Verandah 陽台: - (-)	-	-	-	13.368 (144)	34.258 (369)	-	31.465 (339)	6.716 (72)	-	-
79F Tan Kwai Tsuen Road, Casa Regalia 富豪·悅庭丹桂村路 79F 號	198.435 (2136) Balcony 露台: 3.718 (40) Utility Platform 工作平台: - (-) Verandah 陽台: - (-)	-	-	-	13.368 (144)	24.711 (266)	-	31.465 (339)	6.716 (72)	-	-

- The saleable area of each residential property and the floor areas of every balcony, utility platform or verandah (if any) to the extent that it forms parts of the residential property are calculated in accordance with section 8 of the Residential Properties (First-hand Sales) Ordinance.
- The area of every air-conditioning plant room, bay window, cockloft, flat roof, garden, parking space, roof, stairhood, terrace or yard (if any) to the extent that it forms parts of the residential property is calculated in accordance with Part 2 of Schedule 2 to the Residential Properties (First-hand Sales) Ordinance.

Notes:

- The areas as specified above in square metre are converted into square feet at a rate of 1 square metre = 10.764 square feet and rounded off to the nearest whole square foot.
- There is no verandah in the residential properties of the Development.

- 每個住宅物業的實用面積, 以及構成住宅物業的一部分的範圍內的每一個露台、工作平台或陽台(如有的話)的樓面面積, 是按照《一手住宅物業銷售條例》第8條計算得出的。
- 構成住宅物業的一部分的範圍內的每一空調機房、窗台、閣樓、平台、花園、停車位、天台、梯屋、前庭或庭院(如有的話)的面積, 是按照《一手住宅物業銷售條例》附表2第2部計算得出的。

備註:

- 上述所列以平方米列明之面積, 均以1平方米=10.764平方呎換算至平方呎, 並四捨五入至整數平方呎。
- 發展項目的住宅物業不設陽台。

AREA OF RESIDENTIAL PROPERTIES IN THE DEVELOPMENT
發展項目的住宅物業的面積

Description of Residential Property 物業的描述	Saleable Area (Including balcony, utility platform and verandah, if any) sq. meter (sq. ft.) 實用面積 (包括露台, 工作平台及陽台 (如有)) 平方米 (平方呎)	Area of other specified items (Not included in the Saleable Area) 其他指明項目的面積 (不計算入實用面積) sq. meter (sq. ft.) 平方米 (平方呎)									
		Air-conditioning plant room 空調機房	Bay Window 窗台	Cockloft 閣樓	Flat Roof 平台	Garden 花園	Parking Space 停車位	Roof 天台	Stairhood 梯屋	Terrace 前庭	Yard 庭院
81 Tan Kwai Tsuen Road, Casa Regalia 富豪·悅庭丹桂村路 81 號	362.012 (3897) Balcony 露台: 4.500 (48) Utility Platform 工作平台: - (-) Verandah 陽台: - (-)	-	-	-	13.453 (145)	201.403 (2168)	-	65.637 (707)	7.337 (79)	-	-
83A Tan Kwai Tsuen Road, Casa Regalia 富豪·悅庭丹桂村路 83A 號	251.713 (2709) Balcony 露台: 4.500 (48) Utility Platform 工作平台: - (-) Verandah 陽台: - (-)	-	-	-	6.278 (68)	135.733 (1461)	-	53.599 (577)	3.681 (40)	-	-
83B Tan Kwai Tsuen Road, Casa Regalia 富豪·悅庭丹桂村路 83B 號	251.030 (2702) Balcony 露台: 4.500 (48) Utility Platform 工作平台: - (-) Verandah 陽台: - (-)	-	-	-	6.278 (68)	105.788 (1139)	-	53.599 (577)	3.681 (40)	-	-
83C Tan Kwai Tsuen Road, Casa Regalia 富豪·悅庭丹桂村路 83C 號	251.030 (2702) Balcony 露台: 4.500 (48) Utility Platform 工作平台: - (-) Verandah 陽台: - (-)	-	-	-	6.278 (68)	104.283 (1123)	-	53.599 (577)	3.681 (40)	-	-
83D Tan Kwai Tsuen Road, Casa Regalia 富豪·悅庭丹桂村路 83D 號	251.030 (2702) Balcony 露台: 4.500 (48) Utility Platform 工作平台: - (-) Verandah 陽台: - (-)	-	-	-	6.278 (68)	101.271 (1090)	-	53.599 (577)	3.681 (40)	-	-
83E Tan Kwai Tsuen Road, Casa Regalia 富豪·悅庭丹桂村路 83E 號	251.030 (2702) Balcony 露台: 4.500 (48) Utility Platform 工作平台: - (-) Verandah 陽台: - (-)	-	-	-	6.278 (68)	99.534 (1071)	-	53.599 (577)	3.681 (40)	-	-
83F Tan Kwai Tsuen Road, Casa Regalia 富豪·悅庭丹桂村路 83F 號	251.685 (2709) Balcony 露台: 4.500 (48) Utility Platform 工作平台: - (-) Verandah 陽台: - (-)	-	-	-	6.278 (68)	96.405 (1038)	-	53.599 (577)	3.681 (40)	-	-
83G Tan Kwai Tsuen Road, Casa Regalia 富豪·悅庭丹桂村路 83G 號	251.909 (2712) Balcony 露台: 4.500 (48) Utility Platform 工作平台: - (-) Verandah 陽台: - (-)	-	-	-	6.278 (68)	91.198 (982)	-	53.599 (577)	3.681 (40)	-	-
85A Tan Kwai Tsuen Road, Casa Regalia 富豪·悅庭丹桂村路 85A 號	221.382 (2383) Balcony 露台: 3.718 (40) Utility Platform 工作平台: - (-) Verandah 陽台: - (-)	-	-	-	15.019 (162)	92.207 (993)	-	35.755 (385)	6.862 (74)	-	-

- The saleable area of each residential property and the floor areas of every balcony, utility platform or verandah (if any) to the extent that it forms parts of the residential property are calculated in accordance with section 8 of the Residential Properties (First-hand Sales) Ordinance.
- The area of every air-conditioning plant room, bay window, cockloft, flat roof, garden, parking space, roof, stairhood, terrace or yard (if any) to the extent that it forms parts of the residential property is calculated in accordance with Part 2 of Schedule 2 to the Residential Properties (First-hand Sales) Ordinance.

Notes:

- The areas as specified above in square metre are converted into square feet at a rate of 1 square metre = 10.764 square feet and rounded off to the nearest whole square foot.
- There is no verandah in the residential properties of the Development.

- 每個住宅物業的實用面積, 以及構成住宅物業的一部分的範圍內的每一個露台、工作平台或陽台 (如有的話) 的樓面面積, 是按照《一手住宅物業銷售條例》第8條計算得出的。
- 構成住宅物業的一部分的範圍內的每一空調機房、窗台、閣樓、平台、花園、停車位、天台、梯屋、前庭或庭院 (如有的話) 的面積, 是按照《一手住宅物業銷售條例》附表2第2部計算得出的。

備註:

- 上述所列以平方米列明之面積, 均以1平方米=10.764平方呎換算至平方呎, 並四捨五入至整數平方呎。
- 發展項目的住宅物業不設陽台。

AREA OF RESIDENTIAL PROPERTIES IN THE DEVELOPMENT
發展項目的住宅物業的面積

Description of Residential Property 物業的描述	Saleable Area (Including balcony, utility platform and verandah, if any) sq. meter (sq. ft.) 實用面積 (包括露台, 工作平台及陽台 (如有)) 平方米 (平方呎)	Area of other specified items (Not included in the Saleable Area) 其他指明項目的面積 (不計算入實用面積) sq. meter (sq. ft.) 平方米 (平方呎)									
		Air-conditioning plant room 空調機房	Bay Window 窗台	Cockloft 閣樓	Flat Roof 平台	Garden 花園	Parking Space 停車位	Roof 天台	Stairhood 梯屋	Terrace 前庭	Yard 庭院
85B Tan Kwai Tsuen Road, Casa Regalia 富豪·悅庭丹桂村路 85B 號	222.260 (2392) Balcony 露台: 3.718 (40) Utility Platform 工作平台: - (-) Verandah 陽台: - (-)	-	-	-	15.019 (162)	87.231 (939)	-	35.755 (385)	6.862 (74)	-	-
85C Tan Kwai Tsuen Road, Casa Regalia 富豪·悅庭丹桂村路 85C 號	221.872 (2388) Balcony 露台: 3.718 (40) Utility Platform 工作平台: - (-) Verandah 陽台: - (-)	-	-	-	15.019 (162)	81.428 (876)	-	35.755 (385)	6.862 (74)	-	-
85D Tan Kwai Tsuen Road, Casa Regalia 富豪·悅庭丹桂村路 85D 號	222.562 (2396) Balcony 露台: 3.718 (40) Utility Platform 工作平台: - (-) Verandah 陽台: - (-)	-	-	-	15.019 (162)	74.779 (805)	-	35.755 (385)	6.862 (74)	-	-
87A Tan Kwai Tsuen Road, Casa Regalia 富豪·悅庭丹桂村路 87A 號	206.778 (2226) Balcony 露台: 3.718 (40) Utility Platform 工作平台: - (-) Verandah 陽台: - (-)	-	-	-	13.368 (144)	70.303 (757)	-	31.721 (341)	6.716 (72)	-	-
87B Tan Kwai Tsuen Road, Casa Regalia 富豪·悅庭丹桂村路 87B 號	205.813 (2215) Balcony 露台: 3.718 (40) Utility Platform 工作平台: - (-) Verandah 陽台: - (-)	-	-	-	13.368 (144)	62.034 (668)	-	31.721 (341)	6.716 (72)	-	-
87C Tan Kwai Tsuen Road, Casa Regalia 富豪·悅庭丹桂村路 87C 號	206.662 (2225) Balcony 露台: 3.718 (40) Utility Platform 工作平台: - (-) Verandah 陽台: - (-)	-	-	-	13.368 (144)	54.350 (585)	-	31.721 (341)	6.716 (72)	-	-
87D Tan Kwai Tsuen Road, Casa Regalia 富豪·悅庭丹桂村路 87D 號	203.075 (2186) Balcony 露台: 3.718 (40) Utility Platform 工作平台: - (-) Verandah 陽台: - (-)	-	-	-	13.368 (144)	42.312 (455)	-	31.721 (341)	6.716 (72)	-	-
87E Tan Kwai Tsuen Road, Casa Regalia 富豪·悅庭丹桂村路 87E 號	202.925 (2184) Balcony 露台: 3.718 (40) Utility Platform 工作平台: - (-) Verandah 陽台: - (-)	-	-	-	13.368 (144)	29.463 (317)	-	31.721 (341)	6.716 (72)	-	-
89 Tan Kwai Tsuen Road, Casa Regalia 富豪·悅庭丹桂村路 89 號	417.774 (4497) Balcony 露台: 6.029 (65) Utility Platform 工作平台: - (-) Verandah 陽台: - (-)	-	-	-	7.564 (81)	261.987 (2820)	-	79.984 (861)	7.248 (78)	-	-

- The saleable area of each residential property and the floor areas of every balcony, utility platform or verandah (if any) to the extent that it forms parts of the residential property are calculated in accordance with section 8 of the Residential Properties (First-hand Sales) Ordinance.
- The area of every air-conditioning plant room, bay window, cockloft, flat roof, garden, parking space, roof, stairhood, terrace or yard (if any) to the extent that it forms parts of the residential property is calculated in accordance with Part 2 of Schedule 2 to the Residential Properties (First-hand Sales) Ordinance.

Notes:

- The areas as specified above in square metre are converted into square feet at a rate of 1 square metre = 10.764 square feet and rounded off to the nearest whole square foot.
- There is no verandah in the residential properties of the Development.

- 每個住宅物業的實用面積, 以及構成住宅物業的一部分的範圍內的每一個露台、工作平台或陽台(如有的話)的樓面面積, 是按照《一手住宅物業銷售條例》第8條計算得出的。
- 構成住宅物業的一部分的範圍內的每一空調機房、窗台、閣樓、平台、花園、停車位、天台、梯屋、前庭或庭院(如有的話)的面積, 是按照《一手住宅物業銷售條例》附表2第2部計算得出的。

備註:

- 上述所列以平方米列明之面積, 均以1平方米=10.764平方呎換算至平方呎, 並四捨五入至整數平方呎。
- 發展項目的住宅物業不設陽台。

FLOOR PLANS OF PARKING SPACES IN THE DEVELOPMENT 發展項目中的停車位的樓面平面圖

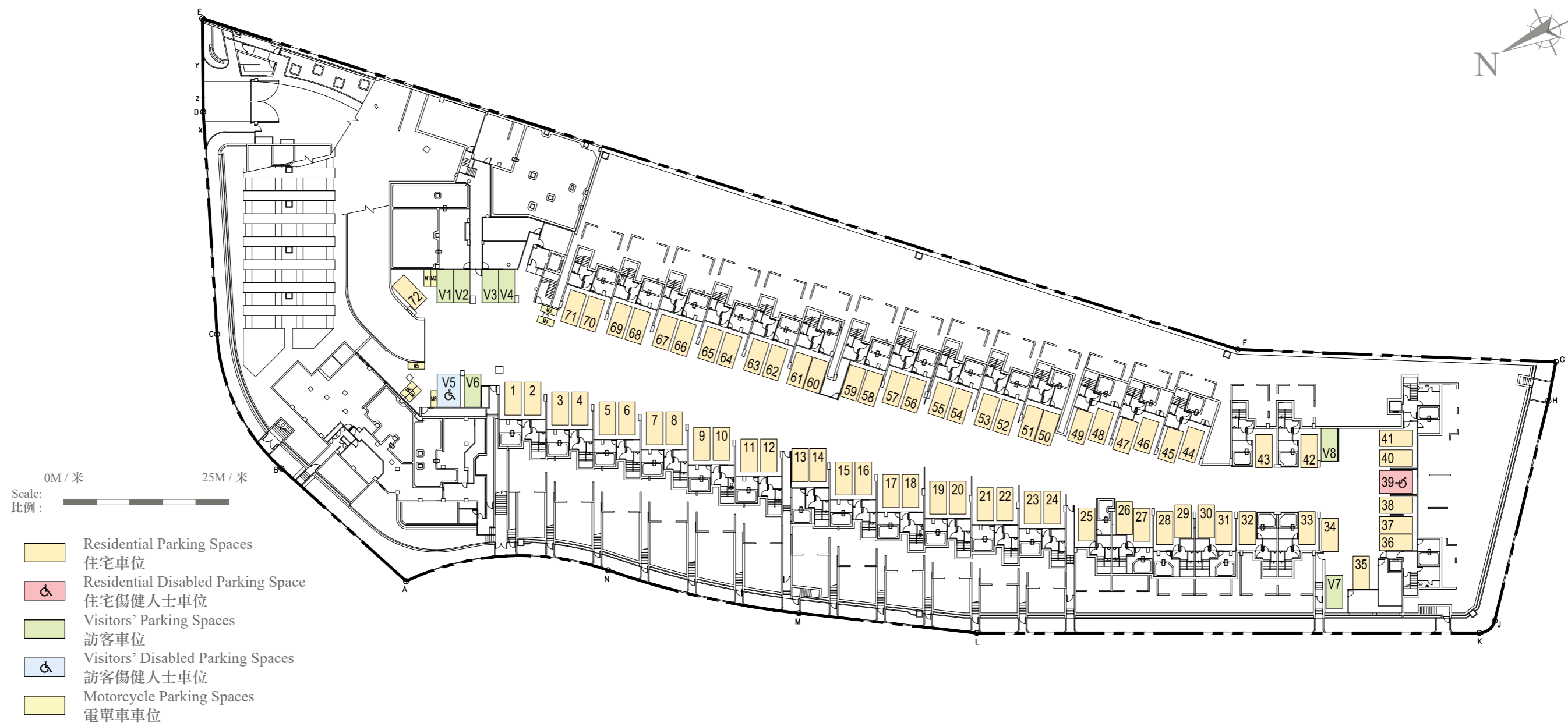

Basement 地庫

Number & Area of Parking Spaces 車位數目及面積

Category of Parking Space 車位類別	Location 位置	Number 數目	Dimensions (Length x Width) (m) 尺寸(長x寬)(米)	Area of each parking space (sq.m.) 每個車位面積(平方米)
Residential Parking Space 住宅車位	Basement 地庫	71	5 x 2.5	12.5
Residential Disabled Parking Space 住宅傷健人士車位		1	5 x 3.5	17.5
Visitors' Parking Space 訪客車位		7	5 x 2.5	12.5
Visitors' Disabled Parking Space 訪客傷健人士車位		1	5 x 3.5	17.5
Motorcycle Parking Space 電單車車位		8	1 x 2.4	2.4

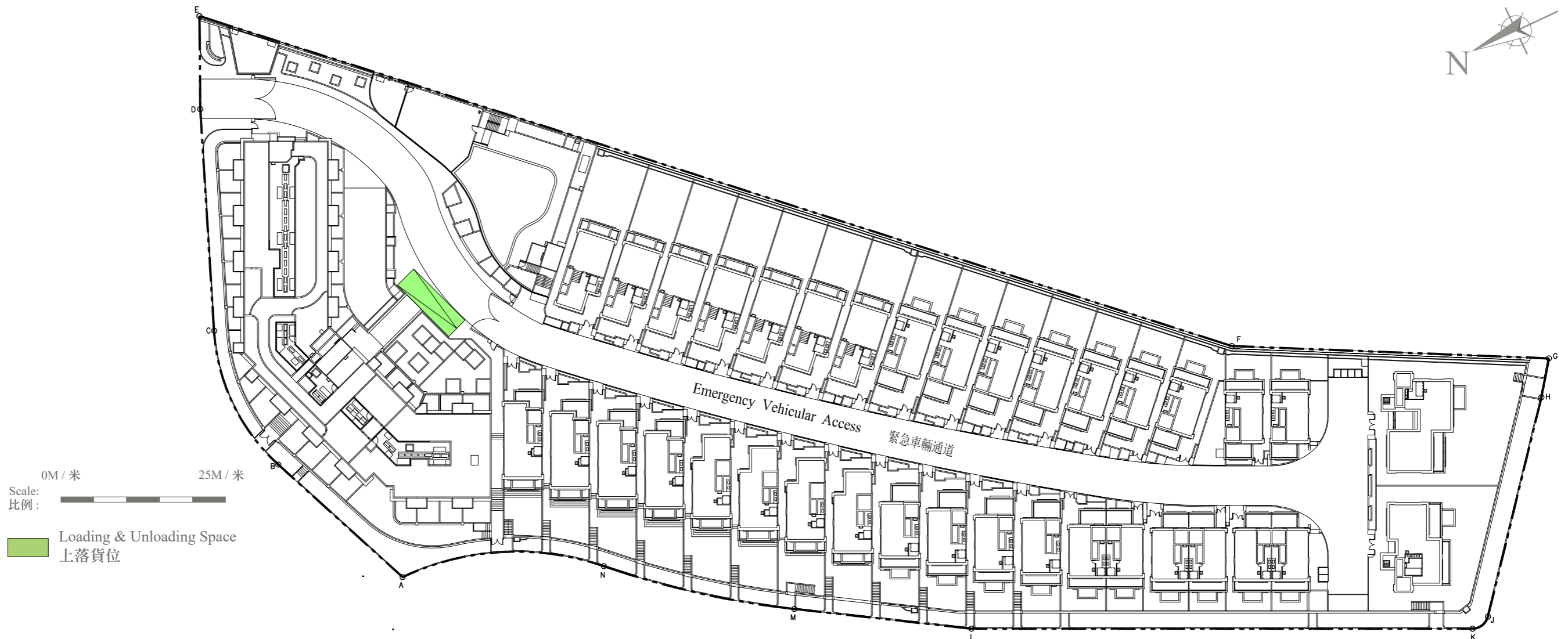

Ground Floor 地下

Number & Area of Parking Spaces 車位數目及面積

Category of Parking Space 車位類別	Location 位置	Number 數目	Dimensions (Length x Width) (m) 尺寸(長x寬)(米)	Area of each parking space (sq.m.) 每個車位面積(平方米)
Loading & Unloading Space 上落貨位	Ground Floor 地下	1	11 x 3.5	38.5

- (1) A preliminary deposit of 5% is payable on the signing of the preliminary agreement for sale and purchase.
 - (2) The preliminary deposit paid by the purchaser on the signing of that preliminary agreement will be held by a firm of solicitors acting for the owner, as stakeholders.
 - (3) If the purchaser fails to execute the agreement for sale and purchase within 5 working days after the date on which the purchaser enters into that preliminary agreement –
 - (i) that preliminary agreement is terminated;
 - (ii) the preliminary deposit is forfeited; and
 - (iii) the owner does not have any further claim against the purchaser for the failure.
- (1) 在簽署臨時買賣合約時須支付款額為5%的臨時訂金。
 - (2) 買方在簽署該臨時合約時支付的臨時訂金，會由代表擁有人行事的律師事務所以保證金保存人的身分持有。
 - (3) 如買方沒有於訂立該臨時合約的日期之後5個工作日內簽立買賣合約 –
 - (i) 該臨時合約即告終止；
 - (ii) 有關的臨時訂金即予沒收；及
 - (iii) 擁有人不得就買方沒有簽立買賣合約而針對買方提出進一步申索。

A. The common parts of the Development

The following terms are defined in the deed of mutual covenant (“DMC”) in respect of the Development:-

1. **“Common Areas”** means collectively the Estate Common Areas, the Residential Development Common Areas, the Apartment Common Areas, the House Common Areas and the Car Park Common Areas and all those parts of the Estate designated as common areas in any Sub-Deed (if any), each of which Common Areas shall, where applicable and not inconsistent with the provisions of the DMC, include those common parts specified in Schedule 1 to the Building Management Ordinance (excluding (i) those parts of the external walls of the Apartment Block which form part of the openable windows, doors, windows and door frames and sealant around windows and door frames forming part of an Apartment Flat and (ii) the external walls, curtain walls, claddings and finishes of the Houses, the internal surfaces of the concrete walls and fence walls facing the Houses or gardens, glass and metal parapets/balustrade/fences of the Houses, flat roofs, windows, window frames and sealant around window frames forming part of the Houses).
2. **“Estate Common Areas”** means those parts of the Estate intended for the common use and benefit of Owners of the Estate as a whole (and not just any particular Unit) and which are subject to the provisions of the DMC and all subsisting rights and rights of way (if any) under the Government Grant to be used by each Owner and Occupier in common with all other Owners and Occupiers of the Estate which said parts include but not limited to the foundations, columns, beams and other structural supports and elements, the Slopes and Retaining Walls, external walls and curtain walls (excluding the external walls which form part of the Residential Development Common Areas, the Apartment Common Areas or the House Common Areas and those parts of the external walls of the Apartment Block which form part of the openable windows, doors, windows and door frames and sealant around windows and door frames forming part of an Apartment Flat and (ii) the external walls, curtain walls, claddings and finishes of the Houses or, the repair and maintenance responsibility thereof rest with the respective Residential Units Owners, Apartment Owners or House Owners), flat roofs and upper roofs (excluding those forming part of any House or the Apartment Common Areas), non-structural prefabricated external walls (excluding those forming part of any Residential Unit, the Clubhouse, the Apartment Common Areas and House Common Areas), the areas for the installation or use of telecommunications network facilities, the areas landscaped in accordance with Special Condition No. (14) of the Government Grant (save and except those areas which form part of the Residential Development Common Areas, the Apartment Common Areas, the House Common Areas and the Car Park Common Areas), the guard house, the office accommodation for watchmen and management staff, the quarters for watchmen and caretakers, the Owners’ Corporation office, run in and run out, portions of the emergency vehicular access on the ground floor, the refuse storage and material recovery chamber, low voltage switch room, sub-main low voltage switch rooms, extra low voltage room, water pump and tank room, fire services and sprinkler pump room (for Clubhouse and Car Park), sprinkler tank (for Clubhouse and Car Park), fire services sprinkler pump room (for Clubhouse and Carpark), street fire hydrant water tank, street hydrant pump room, gas kiosk, TBE (telephone and broadcasting equipment) room, lift lobbies and lift staircases (from basement to roof) in the Clubhouse, lift pit, fence walls along the boundary of the Development (except the internal surface of these fence walls facing the private gardens, the repair and maintenance responsibility thereof rest with the respective Residential Units Owners), fire service control room, Transformer Room, master meter room, water meter cabinet, sprinkler inlet & control valve group, excavated areas, the Common Greenery Areas within the Estate Common Areas and such additional areas of the Estate as may at any time be designated as Estate Common Areas by the vendor subject to the approval by a resolution of Owners at an Owners’ meeting convened in accordance with the provisions of the DMC which Estate Common Areas are for the purpose of identification shown and coloured green on the Common Areas Plan (Basement Floor) and Common Areas Plan (Ground Floor) and the Common Greenery Areas Plan and marked Plan Nos. 1 and 2 and 15, the accuracy of such plans is certified by the Authorized Person.
3. **“Residential Development Common Areas”** means those parts of the Residential Development intended for the common use and benefit of the Owners of the Residential Units as a whole (and not just any particular Residential Unit) and which are subject to the provisions of the DMC to be used by each Owner and Occupier of the Residential Units in common with all other Owners and Occupiers of the Residential Units and shall include but not limited to the Visitors’ Parking Spaces, the Loading and Unloading Bay, the Recreational Areas and Facilities including but not limited to the Clubhouse (including the external walls and roofs thereof), the Common Greenery Areas within the Residential Development Common Areas, and such additional areas of the Estate as may at any time be designated as Residential Development Common Areas by the vendor subject to the approval by a resolution of the Owners at an Owners’ meeting convened in accordance with the provisions of the DMC, which Residential Development Common Areas are for the purpose of identification shown and coloured pink on the Common Areas Plan (Basement Floor) and the Common Areas Plan (Ground Floor) and the Common Greenery Plan annexed to the DMC and marked Plan Nos. 1, 2 and 15, the accuracy of such plans is certified by the Authorized Person.
4. **“Apartment Common Areas”** means those parts of the Apartment Block intended for the common use and benefit of the Owners of the Apartment Flats as a whole (and not just any particular Apartment Flat) and which are subject to the provisions of the DMC to be used by each Owner and Occupier of the Apartment Flats in common with all other Owners and Occupiers of the Apartment Flats and shall include but not limited to areas in the Apartment Block for the installation or use of aerial broadcast distribution facilities, the pipe ducts, the

roofs and upper roofs of Apartment Block, the air-conditioning outdoor areas, the wider corridors and lift lobbies, the lifts in the Apartment Block, lift pits, canopies and areas underneath canopies, the water meter rooms, the electric rooms, the satellite master antenna television (SMATV) room, the electric low voltage & telephone rooms, the water meter cabinets, the sprinkler water tank (for Apartment), the fire service water tank (for Apartment), sprinkler and fire service pump room (for Apartment), fire service pump and tank room, the refuse storage & material recovery rooms, ventilation ducts, the external walls and curtain walls of the Apartment Block (but excluding openable windows, doors, windows and door frames and sealant around windows and door frames, and the interior side of the curtain wall for the exclusive use by the Owners and Occupiers of the Apartment Flats, the internal surfaces of the concrete walls and fence walls facing the Apartment Flats or gardens, the railings and glass balustrades of the balconies and the covered areas underneath the balconies forming part of the Apartment Flats, the cleaning repair and maintenance responsibility thereof rests with the respective Owners of the Apartment Flats), the roof features on roofs and upper roofs (if any) not forming part of Apartment Flats, the planters, the lawns and the mounting frames in the air-conditioning outdoor areas on the roofs of the Apartment Block, the Common Greenery Areas within the Apartment Common Areas and soil backfill areas underneath the Apartment Block and such additional areas of the Estate as may at any time be designated as Apartment Common Areas by the vendor subject to the approval by a resolution of the Owners at an Owners’ meeting convened in accordance with the provisions of the DMC, which Apartment Common Areas are for the purpose of identification shown and coloured orange on the Common Areas Plan (Basement Floor), Common Areas Plan (Ground Floor), Common Areas Plan (Apartment Ground Floor), Common Areas Plan (Apartment 1st-3rd Floor) and Common Areas Plan (Apartment Roof and Upper Roof) and the Common Greenery Areas Plan annexed to the DMC and marked Plan Nos. 1, 2, 3, 4, 5 and 15 and the accuracy of such plans is certified by the Authorized Person.

5. **“House Common Areas”** means those parts of the House Development intended for the common use and benefit of the Owners of the Houses as a whole (and not just any particular House) and which are subject to the provisions of the DMC to be used by each Owner and Occupier of the Houses in common with all other Owners and Occupiers of the Houses and shall include but not limited to the portions of the emergency vehicular access road, the Common Greenery Areas within the House Common Areas, soil backfill areas, external walls of the House Development (but excluding the external walls, curtain walls, claddings and finishes of the Houses, the internal surfaces of the concrete walls and fence walls facing the Houses or gardens, glass and metal parapets/balustrade/fences of the Houses, flat roofs, upper roofs, windows, window frames and sealant around window frames forming part of the Houses, the cleaning repair and maintenance responsibility rests with the Owners thereof) and such additional areas of the Estate as may at any time be designated as House Common Areas by the vendor subject to the approval by a resolution of Owners at an Owners’ meeting convened in accordance with the provisions of the DMC which House Common Areas are for the purpose of identification shown and coloured violet on the Common Areas Plan (Basement Floor) and the Common Areas Plan (Ground Floor) and the Common Greenery Areas Plan annexed to the DMC and marked Plan Nos. 1 and 2 and 15 and the accuracy of such plans is certified by the Authorized Person.
6. **“Car Park Common Areas”** means all those parts of the Car Park (excluding the Parking Spaces) intended for the common use and benefit of the Owners of the Parking Spaces as a whole (and not just any particular Residential Parking Space or Motor Cycle Parking Space) which are subject to the provisions of the DMC to be used by each Owner and Occupier of the Residential Parking Spaces and Motor Cycle Parking Spaces and each user of the Visitors’ Parking Spaces in common with all other Owners and Occupiers of such Residential Parking Spaces and Motor Cycle Parking Spaces and users of the Visitors’ Parking Spaces, including but not limited to, the driveway on the basement floor, the manoeuvring area and passages therein, the carpark exhaust fan room, the exhaust air fan room and such additional areas of the Estate as may at any time be designated as Car Park Common Areas by the vendor subject to the approval by a resolution of Owners at an Owners’ meeting convened in accordance with the provisions of the DMC, which Car Park Common Areas are for the purpose of identification shown coloured yellow on the Common Areas Plan (Basement Floor) and Common Areas Plan (Ground Floor) annexed to the DMC and marked Plan Nos. 1 and 2 and the accuracy of such plans is certified by the Authorized Person.
7. **“Common Facilities”** means collectively the Estate Common Facilities, the Residential Development Common Facilities, the Apartment Common Facilities, the House Common Facilities and the Car Park Common Facilities and all those facilities of the Estate designated as common facilities in any Sub-Deed (if any).
8. **“Estate Common Facilities”** means all those facilities and installation in the Estate used in common by or installed or intended for the common use and benefit of the Estate as a whole as part of the amenities thereof and not just for the exclusive benefit of any particular part thereof which are subject to the provisions of the DMC to be used by each Owner and Occupier in common with all other Owners and Occupiers of the Estate and includes but not limited to sewers, drains, gutters, manholes, storm water drains, water courses, channels, water mains, cables, pipes, wires, ducts, flushing mains, fresh water mains, gas valve, fire services installations, fire fighting equipment, fire hydrant, hose reel system, sprinkler system, fire alarm system, emergency generator, emergency lighting system, portable appliances, exit signs, visual fire alarm system, security equipment and facilities, ventilation fans, lights, lightning post, lightning rods, sanitary fittings, refuse disposal equipment, communal aerials, equipment, plant and machinery and other like installations, facilities or services

and such additional devices and facilities of the Estate as may at any time be designated as Estate Common Facilities by the vendor subject to the approval by a resolution of Owners at an Owners' meeting convened in accordance with the provisions of the DMC.

9. **“Residential Development Common Facilities”** means all those facilities and installations of the Residential Development intended for the common use and benefit of the Owners of the Residential Units as a whole (and not just any particular Residential Unit) and which are subject to the provisions of the DMC to be used by each Owner and Occupier of the Residential Units in common with all other Owners and Occupiers of the Residential Units and includes but not limited to charging points and/or controllers (if any) for electric cars and/or hybrid cars for the Visitors' Parking Spaces, the plant equipment and facilities for the Recreational Areas and Facilities, wires, cables, ducts, pipes, drains, fire services installations, security installations and all mechanical and electrical installations and facilities and equipment exclusively for the Residential Development Common Areas and such additional devices and facilities of the Estate as may be approved by a resolution of Owners at an Owners' meeting convened in accordance with the provisions of the DMC.
10. **“Apartment Common Facilities”** means all those facilities and installations of the Apartment Block intended for the common use and benefit of the Owners of the Apartment Flats as a whole (and not just any particular Apartment Flat) and which are subject to the provisions of the DMC to be used by each Owner and Occupier of the Apartment Flats in common with all other Owners and Occupiers of the Apartment Flats and includes but not limited to the lifts in the Apartment Block, all wires, cables, ducts, pipes, drains, fire services installations, security installations and all mechanical and electrical installations and equipment exclusively for the Apartment Block and such additional devices and facilities of the Estate as may at any time be designated as Apartment Common Facilities by the vendor subject to the approval by a resolution of Owners at an Owners' meeting convened in accordance with the provisions of the DMC. For the avoidance of doubt, those installations made by and belonging to the provider(s) of the telecommunications and broadcasting services (if any) shall not form parts of the Apartment Common Facilities.
11. **“House Common Facilities”** means all those facilities and installations of the House Development intended for the common use and benefit of the Owners of the Houses as a whole (and not just any particular House) which are subject to the provisions of the DMC to be used by each Owner and Occupier of the Houses in common with all other Owners and Occupiers of the Houses and includes but not limited to the wires, cables, ducts, pipes, drains, and all mechanical and electrical installations and equipment exclusively for the House Development as a whole (and not just any particular House) and such additional devices and facilities of the Estate as may at any time be designated as House Common Facilities by the vendor subject to the approval by a resolution of Owners at an Owners' meeting convened in accordance with the provisions of the DMC. For the avoidance of doubt, those installations made by and belonging to the provider(s) of the telecommunications and broadcasting services (if any) shall not form parts of the House Common Facilities.
12. **“Car Park Common Facilities”** means all those facilities and installations of the Car Park intended for the common use and benefit of the Owners of the Parking Spaces as a whole (and not just any particular Residential Parking Space or Motor Cycle Parking Space) which are subject to the provisions of the DMC to be used by each Owner and Occupier of the Residential Parking Spaces and Motor Cycle Parking Spaces and each user of the Visitors' Parking Spaces in common with all other Owners and Occupiers of such Residential Parking Spaces and Motor Cycle Parking Spaces and users of the Visitors' Parking Spaces, including but not limited to charging points and/or controllers (if any) for electric cars and/or hybrid cars, electrical installations, exhaust ducts, exhaust fans, pumps, drainage, lightings, fire services installations, service equipment and petrol interceptor and such additional devices and facilities of the Estate as may at any time be designated as Car Park Common Facilities by the vendor subject to the approval by a resolution of Owners at an Owners' meeting convened in accordance with the provisions of the DMC.

B. The number of undivided shares assigned to each residential property in the Development

Domus

Floor	Flat	Undivided shares for each residential property	Floor	Flat	Undivided shares for each residential property	
G/F	1	547	1/F-3/F	1	451	
	2	407		2	451	
	3	489		3	431	
	5	421		5	508	
	6	423		6	451	
	7	424		7	451	
	8	425		8	451	
	9	427		9	451	
	10	428		10	451	
	11	430		11	451	
	12	434		12	451	
	15	368		15	458	
	16	423		16	406	
	17	421		17	454	
	18	421		18	451	
	19	421		19	451	
	20	421		20	451	
	21	422		21	451	
	22	440		22	451	
	23	432		23	465	
	25	425		25	517	
	26	432		26	451	
	27	435		27	454	
	28	427		28	454	
	29	376		31	451	
	30	435		32	451	
	31	430		33	451	
	32	430		35	457	
	33	426		36	471	
	35	445		37	451	
	36	434		38	451	
	37	436		39	451	
	38	445		29	454	
				30	399	
				3/F	30	853

House

House	Undivided shares for each residential property	House	Undivided shares for each residential property
67A Tan Kwai Tsuen Road, Casa Regalia	5522	81 Tan Kwai Tsuen Road, Casa Regalia	7816
67B Tan Kwai Tsuen Road, Casa Regalia	5556	83A Tan Kwai Tsuen Road, Casa Regalia	5433
69A Tan Kwai Tsuen Road, Casa Regalia	5552	83B Tan Kwai Tsuen Road, Casa Regalia	5360
69B Tan Kwai Tsuen Road, Casa Regalia	5554	83C Tan Kwai Tsuen Road, Casa Regalia	5357
71A Tan Kwai Tsuen Road, Casa Regalia	5460	83D Tan Kwai Tsuen Road, Casa Regalia	5351
71B Tan Kwai Tsuen Road, Casa Regalia	5460	83E Tan Kwai Tsuen Road, Casa Regalia	5347
73A Tan Kwai Tsuen Road, Casa Regalia	5441	83F Tan Kwai Tsuen Road, Casa Regalia	5354
73B Tan Kwai Tsuen Road, Casa Regalia	5428	83G Tan Kwai Tsuen Road, Casa Regalia	5348
75A Tan Kwai Tsuen Road, Casa Regalia	4696	85A Tan Kwai Tsuen Road, Casa Regalia	4728
75B Tan Kwai Tsuen Road, Casa Regalia	4685	85B Tan Kwai Tsuen Road, Casa Regalia	4735
77A Tan Kwai Tsuen Road, Casa Regalia	4670	85C Tan Kwai Tsuen Road, Casa Regalia	4715
77B Tan Kwai Tsuen Road, Casa Regalia	4663	85D Tan Kwai Tsuen Road, Casa Regalia	4716
79A Tan Kwai Tsuen Road, Casa Regalia	4196	87A Tan Kwai Tsuen Road, Casa Regalia	4380
79B Tan Kwai Tsuen Road, Casa Regalia	4137	87B Tan Kwai Tsuen Road, Casa Regalia	4344
79C Tan Kwai Tsuen Road, Casa Regalia	4173	87C Tan Kwai Tsuen Road, Casa Regalia	4345
79D Tan Kwai Tsuen Road, Casa Regalia	4151	87D Tan Kwai Tsuen Road, Casa Regalia	4250
79E Tan Kwai Tsuen Road, Casa Regalia	4141	87E Tan Kwai Tsuen Road, Casa Regalia	4222
79F Tan Kwai Tsuen Road, Casa Regalia	4122	89 Tan Kwai Tsuen Road, Casa Regalia	9069

C. The terms of years for which the manager of the Development is appointed

The manager for the Development shall be appointed for an initial term of two (2) years commencing from the date of the DMC and to be continued thereafter unless and until terminated in writing in accordance with the terms of the DMC.

D. The basis on which the management expenses are shared among the owners of the residential properties in the Development;

1. The Owner of each Apartment Flat shall pay the due contribution of the annual expenditure in accordance with the Apartment Management Budget which due proportion shall be the same proportion as the number of Management Units allocated to his Apartment Flat bears to the total number of Management Units allocated to all the Apartment Flats.
2. The Owner of each House shall pay the due contribution of the annual expenditure in accordance with the House Management Budget which due proportion shall be the same proportion as the number of Management Units allocated to his House bears to the total number of Management Units allocated to all the Houses.

E. The basis on which the management fee deposit is fixed

The management fee deposit is equal to three (3) months of the monthly contribution to the Management Charges in respect of the Unit based on the first annual Management Budgets which amount shall be transferable.

F. The area in the Development retained by the vendor for the vendor's own use

Not applicable.

Note:

For full details, please refer to the DMC which is free for inspection during opening hours at the sales office. Full script of the DMC is available for inspection upon request and copies of the DMC can be obtained upon paying necessary photocopying charges.

A. 發展項目的公用部分

發展項目公契（「公契」）對下列條款之定義界定如下：

1. 「公用地方」統指屋苑公用地方、住宅發展項目公用地方、公寓公用地方、洋房公用地方、停車場公用地方及任何公契分契（如有）指定作為公用地方的屋苑所有該等部分。如適用和在不抵觸本公契的規定下，每項公用地方包括建築物管理條例第一附表指定的該等公用部分（不包括（i）公寓大廈外牆構成活動窗戶之部分的該等部分、構成公寓單位部分的門、窗、門框及窗戶周圍的密封膠及門框；及（ii）洋房的外牆，幕牆、面板及飾面、混凝土牆的內部飾面、洋房圍牆內面、洋房的花園、玻璃及金屬護牆/扶手/圍欄、構成洋房之部分的平台、窗戶、窗框及窗框周圍的密封膠）。
2. 「屋苑公用地方」指擬供整個屋苑（並非僅任何個別單位）的業主共同使用與享用屋苑的該等部分。該等部分由每個業主和佔用人與屋苑所有其他的業主和佔用人共同使用，受制於公契條文和政府批地文件規定的一切存續權及道路權（如有）。該等部分包括但不限於地基、支柱、大樑和其他結構承托物及部件、斜坡及護土牆、外牆和幕牆（不包括構成住宅發展項目公用地方、公寓公用地方或洋房公用地方之部分的外牆和公寓大廈外牆構成活動窗戶之部分的該等部分、構成公寓單位之部分的門、窗、窗框、窗周圍的密封膠及門框或洋房或住宅單位業主、公寓業主或洋房業主有責任維修與保養的外牆、幕牆、面板及飾面）、平台、上層屋頂（不包括構成任何洋房或公寓公用地方之部分）、非結構預製外牆（不包括構成任何住宅單位、會所、公寓公用地方及洋房公用地方之部分）、安裝或使用電訊網絡設施的區域、按政府批地文件特別條款第（14）條美化的區域（構成住宅發展項目公用地方、公寓公用地方、洋房公用地方及停車場公用地方之部分除外）、保安員室、看更及管理職員的辦公場所、看更及管理員的宿舍、業主立案法團處、進口及出口、地面緊急車輛通道部分、垃圾存放及物料回收室、低電壓電掣房、次主低壓電掣房、超低電壓房、水泵及水箱房、消防及灑水器泵房（供會所及停車場使用）、灑水器水箱（供會所及停車場使用）、消防灑水器泵房（供會所及停車場使用）、街道消防栓水箱、街道消防栓泵房、煤氣站、TBE（電話及廣播設備）房、會所升降機大堂、升降機及樓梯（從地庫至天台）、升降機井、發展項目邊界圍牆（有關住宅單位業主有責任維修及保養的私人花園圍牆內面除外）、消防控制室、變壓器室、主儀錶室、水錶櫃、灑水器進水口及控制閥組件、挖掘區、屋苑公用地方內的公共綠化區和賣方在任何時候指定並經業主在按公契規定召開的業主大會上通過決議批准作為屋苑公用地方的屋苑該等新增區域。屋苑公用地方在公契附錄並註明1、2及15號圖則（經認可人士核實為準確）的公用地方圖則（地庫層）、公用地方圖則（地面層）及公共綠化區圖則上用綠色顯示，以供識別。
3. 「住宅發展項目公用地方」指擬供所有住宅單位（並非僅任何個別單位）的業主共同使用與享用住宅發展項目的該等部分。該等部分由每個住宅單位業主和佔用人與所有其他住宅單位業主和佔用人共同使用，受制於公契條文。該等部分包括但不限於訪客車位、裝卸區、康樂區及設施，包括但不限於會所（包括其外牆及天台）、住宅發展項目公用地方內的公共綠化區和賣方在任何時候指定並經業主在按公契規定召開的業主大會上通過決議批准作為住宅發展項目公用地方的屋苑該等新增區域。住宅發展項目公用地方在公契附錄並註明1、2及15號圖則（經認可人士核實為準確）的公用地方圖則（地庫層）、公用地方圖則（地面層）及公共綠化區圖則上用粉紅色顯示，以供識別。
4. 「公寓公用地方」指擬供所有公寓單位（並非僅任何個別公寓單位）的業主共同使用與享用公寓大廈的該等部分。該等部分由每個公寓單位業主和佔用人與所有其他公寓單位業主和佔用人共同使用，受制於公契條文。該等部分包括但不限於公寓大廈內供安裝或使用無線廣播分導設施的區域、管槽、公寓大廈的天台及上層屋頂、空調機室外區域、加寬走廊及升降機大堂、公寓大廈內的升降機、升降機井、簷篷及簷篷底下區域、水錶房、電力房、衛星主天線電視（SMATV）室、低電壓及電話房、水錶櫃、灑水器水箱（供公寓使用）、消防水箱（供公寓使用）、灑水器及消防泵房（供公寓使用）、消防泵及水箱房、垃圾存放及物料回收室、通風槽、公寓大廈的外牆及幕牆（但不包括公寓單位業主和佔用人獨家使用的活動窗戶、門、窗戶、門框、窗戶和門框周圍的密封膠及幕牆內面、公寓單位混凝土牆及圍牆的內部飾面或公寓單位業主負責清潔、維修及保養構成公寓單位之部分的花園、露台的欄杆和玻璃矮牆和露台下面的有蓋區域）、並非構成公寓單位之部分的天台及上層屋頂（如有）的天台裝飾、花槽、草坪和公寓大廈天台的空調機室外區域的安裝架、公寓公用地方的公共綠化區、公寓大廈下面的土方回填區和賣方在任何時候指定並經業主在按公契規定召開的業主大會上通過決議批准作為公寓公用地方的屋苑該等新增區域。公寓公用地方在公契附錄並註明1、2、3、4、5及15號圖則（經認可人士核實為準確）的公用地方圖則（地庫層）、公用地方圖則（地面層）、公用地方圖則（公寓地面層）、公用地方圖則（公寓1-3樓）、公用地方圖則（公寓天台及上層屋頂）及公共綠化區圖則上用橙色顯示，以供識別。
5. 「洋房公用地方」指擬供所有洋房（並非僅任何個別洋房）的業主共同使用與享用洋房發展項目的該等部分。該等部分由每個洋房業主和佔用人與所有其他洋房業主和佔用人共同使用，受制於公契條文。該等部分包括但不限於緊急車輛通道、洋房公用地方內的公共綠化區、土方回填區、洋房發展項目外牆（不包括洋房的外牆、幕牆、面板及飾面、洋房的混凝土牆及圍牆的內部飾面或洋房的花園、玻璃及金屬護牆/扶手/圍欄、洋房業主有責任維修與保養構成洋房之部分的平台、上層屋頂、窗戶、窗框、窗框周圍的密封膠）和賣方在任何時候指定並經業主在按公契規定召開的業主大會上通過決議批准作為洋房公用地方的屋苑該等新增區域。洋房公用地方在公契附錄並註明1、2及15號圖則（經認可人士核實為準確）的公用地方圖則（地庫層）、公用地方圖則（地面層）及公共綠化區圖則上用紫色顯示，以供識別。
6. 「停車場公用地方」指供所有車位（但並非僅任何個別住宅車位或電單車車位）業主共同使用與享用的停車場所有該等部分（不包括車位）。該等部分由每個住宅車位和電單車車位業主和佔用人及每個訪客車位使用者與所有其他住宅車位和電單車車位業主和佔用人及訪客車位使用者共同使用，受制於公契條文，包括但不限於地庫層車道、調度區及通道、停車場抽風機室、排氣扇室和賣方在任何時候指定並經業主在按公契規定召開的業主大會上通過決議批准作為停車場公用地方的屋苑該等新增區域。停車場公用地方在公契附錄並註明1和2號圖則（經認可人士核實為準確）的公用地方圖則（地庫層）和公用地方圖則（地面層）上用黃色顯示，以供識別。
7. 「公共設施」統指屋苑公共設施、住宅發展項目公共設施、公寓公共設施、洋房公共設施、停車場公共設施及任何公契分契（如有）指定作為公共設施的屋苑所有該等部分。
8. 「屋苑公共設施」指安裝作為其便利設施部分或擬供整個屋苑共同使用與享用，但並非僅供其中任何個別部分獨家享用的屋苑內的所有該等設施及裝置。屋苑公共設施由每個業主和佔用人與屋苑所有其他業主和佔用人共同使用，受公契條文規限，包括但不限於污水渠、排水渠、明渠、沙井、雨水排水渠、水道、渠道、總水喉、電纜、管道、電線、槽、沖廁水總喉、食水總喉、煤氣閥、消防裝置、滅火設備、消防栓、消防喉轆系統、灑水器系統、火警鐘系統、緊急發電機、緊急照明系統、攜帶式裝置、出口標誌、圖像火警報系統、保安設備及設施、通風扇、照明、燈柱、避雷針、衛生裝置、垃圾處理設備、公共天線、設備、機械、機器及其他類似裝置設施、服務和賣方在任何時候指定並經業主在按公契規定召開的業主大會上通過決議批准作為屋苑公共設施的屋苑該等新增設備及設施。
9. 「住宅發展項目公共設施」指擬供所有住宅單位（並非僅任何個別住宅單位）業主共同使用與享用並在公契的規限下由每個住宅單位業主及佔用人與所有其他住宅單位業主及佔用人共同使用的住宅發展項目的所有該等設施及裝置，包括但不限於訪客車位的電動車及/或混合動力車的充電接口及/或控制器（如有）、康樂區及設施的機械、設備及設施，供住宅發展項目公用地方專用的電線、電纜、槽、管道、排水渠、消防裝置、保安裝置及一切機電裝置、設施及設備及經業主在按公契規定召開的業主大會上通過決議批准的屋苑該等新增設備及設施。
10. 「公寓公共設施」指擬供所有公寓單位（並非僅任何個別公寓單位）的業主共同使用與享用公寓大廈的所有該等設施及裝置。該等設施及裝置由每個公寓單位業主和佔用人與所有其他公寓單位業主和佔用人共同使用，受制於公契條文，包括但不限於公寓大廈內的升降機、所有電線、電纜、槽、管道、排水渠、消防裝置、保安裝置、所有機械及電力裝置及專門服務公寓大廈的設備和賣方在任何時候指定並經業主在按公契規定召開的業主大會上通過決議批准作為公寓公共設施的屋苑該等新增設備及設施。為免存疑，由電訊及廣播服務供應商（如有）安裝及擁有的該等裝置不屬於公寓公共設施之部分。
11. 「洋房公共設施」指擬供所有洋房（並非僅任何個別洋房）業主共同使用與享用並在公契的規限下由每座洋房業主及佔用人與所有其他洋房業主及佔用人共同使用的洋房發展項目的所有該等設施及裝置，包括但不限於供整個洋房發展項目（並非僅任何個別洋房）專用的電線、電纜、槽、管道、排水渠和一切機電裝置及設備及賣方在任何時候指定並經業主在按公契規定召開的業主大會上通過決議批准作為洋房公共設施的屋苑該等新增設備及設施。為免存疑，電訊廣播服務供應商（如有）安裝和擁有的該等裝置不屬於洋房公共設施之部分。
12. 「停車場公共設施」指供所有車位（但並非僅任何個別住宅車位或電單車車位）業主共同使用與享用的停車場所有該等設施及裝置。該等設施及裝置由每個住宅車位和電單車車位業主和佔用人及每個訪客車位使用者與所有其他住宅車位和電單車車位業主和佔用人及訪客車位使用者共同使用，受制於公契條文，包括但不限於電動車及/或混合動力車的充電站及控制器、電力裝置、排氣管、抽風機、泵、排水渠、照明、消防裝置、服務設備及截油器和賣方在任何時候指定並經業主在按公契規定召開的業主大會上通過決議批准作為停車場公共設施的屋苑該等新增設備及設施。

B. 分配予發展項目中的每個住宅物業的不分割份數數目

尚築

樓層	單位	每個住宅物業之不分割份數
地下	1	547
	2	407
	3	489
	5	421
	6	423
	7	424
	8	425
	9	427
	10	428
	11	430
	12	434
	15	368
	16	423
	17	421
	18	421
	19	421
	20	421
	21	422
	22	440
	23	432
	25	425
	26	432
	27	435
	28	427
	29	376
	30	435
	31	430
	32	430
	33	426
	35	445
	36	434
	37	436
	38	445

樓層	單位	每個住宅物業之不分割份數	
1樓至3樓	1	451	
	2	451	
	3	431	
	5	508	
	6	451	
	7	451	
	8	451	
	9	451	
	10	451	
	11	451	
	12	451	
	15	458	
	16	406	
	17	454	
	18	451	
	19	451	
	20	451	
	21	451	
	22	451	
	23	465	
	25	517	
	26	451	
	27	454	
	28	454	
	31	451	
	32	451	
	33	451	
	35	457	
	36	471	
	37	451	
	38	451	
	39	451	
	1樓至2樓	29	454
	2樓	30	399
	3樓	30	853

洋房

洋房	每個住宅物業之不分割份數
富豪·悦庭丹桂村路 67A 號	5522
富豪·悦庭丹桂村路 67B 號	5556
富豪·悦庭丹桂村路 69A 號	5552
富豪·悦庭丹桂村路 69B 號	5554
富豪·悦庭丹桂村路 71A 號	5460
富豪·悦庭丹桂村路 71B 號	5460
富豪·悦庭丹桂村路 73A 號	5441
富豪·悦庭丹桂村路 73B 號	5428
富豪·悦庭丹桂村路 75A 號	4696
富豪·悦庭丹桂村路 75B 號	4685
富豪·悦庭丹桂村路 77A 號	4670
富豪·悦庭丹桂村路 77B 號	4663
富豪·悦庭丹桂村路 79A 號	4196
富豪·悦庭丹桂村路 79B 號	4137
富豪·悦庭丹桂村路 79C 號	4173
富豪·悦庭丹桂村路 79D 號	4151
富豪·悦庭丹桂村路 79E 號	4141
富豪·悦庭丹桂村路 79F 號	4122

洋房	每個住宅物業之不分割份數
富豪·悦庭丹桂村路 81 號	7816
富豪·悦庭丹桂村路 83A 號	5433
富豪·悦庭丹桂村路 83B 號	5360
富豪·悦庭丹桂村路 83C 號	5357
富豪·悦庭丹桂村路 83D 號	5351
富豪·悦庭丹桂村路 83E 號	5347
富豪·悦庭丹桂村路 83F 號	5354
富豪·悦庭丹桂村路 83G 號	5348
富豪·悦庭丹桂村路 85A 號	4728
富豪·悦庭丹桂村路 85B 號	4735
富豪·悦庭丹桂村路 85C 號	4715
富豪·悦庭丹桂村路 85D 號	4716
富豪·悦庭丹桂村路 87A 號	4380
富豪·悦庭丹桂村路 87B 號	4344
富豪·悦庭丹桂村路 87C 號	4345
富豪·悦庭丹桂村路 87D 號	4250
富豪·悦庭丹桂村路 87E 號	4222
富豪·悦庭丹桂村路 89 號	9069

C. 有關發展項目的管理人的委任期

發展項目管理人的任期將為本公契之日起的初期2年，其後繼續任期直至按公契條款以書面形式終止。

D. 管理開支按甚麼基準在發展項目中的住宅物業擁有人之間分擔：

1. 每個公寓單位業主須按公寓管理預算支付年度開支中的適當分擔款項，該適當分擔款項為他的公寓單位獲分配的管理單位數目對所有公寓單位獲分配的總管理單位之相同比例。
2. 每座洋房業主須按洋房管理預算支付年度開支中的適當分擔款項，該適當分擔款項為他的洋房獲分配的管理單位數目對所有洋房獲分配的總管理單位之相同比例。

E. 計算管理費按金的基準

管理費按金相等於該單位按首個年度管理預算應付每月管理費分擔款項之3個月款項，該款項可以轉讓。

F. 賣方在發展項目中保留作自用的範圍

不適用

備註：

如欲知全部詳情，請參閱公契。公契可在售樓處開放時間內免費查閱並繳交必要的影印費後可索取公契之全文。

A. The lot number of the land on which the Development is situated

The Development is constructed on Lot No. 4309 in Demarcation District No. 124 (the “Lot”).

B. The term of years under the lease

The term of years of the Lot under New Grant No. 21285 (the “Land Grant”) is 50 years from 6 September 2011.

C. The user restrictions applicable to that land

1. Special Condition No. (8) of the Land Grant stipulates that:

The Lot or any part thereof or any building or part of any building erected or to be erected thereon shall not be used for any purpose other than for private residential purposes.

2. Special Condition No. (11) of the Land Grant stipulates that:

Notwithstanding the user restriction stipulated in Special Condition No. (8) of the Land Grant and the maximum gross floor area and site coverage permitted under Special Condition No. (9) of the Land Grant, the Grantee may use part or parts of the building or buildings erected or to be erected on the Lot in accordance with the Conditions of the Land Grant and erect on part or parts of the Lot separate temporary structures for the purposes of a sales office and show flats and related marketing activities to facilitate the sale of the building or buildings or any part or parts thereof erected or to be erected on the Lot in accordance with the conditions of the Land Grant, provided that the scale and period of operation of such sales office and show flats and related marketing activities shall be subject to the prior written approval of the Director of Lands (the “Director”).

3. Special Condition No. (12)(c)(iii) of the Land Grant stipulates that:

the Exempted Facilities shall only be used by the residents of the residential block or blocks erected or to be erected on the Lot and their bona fide visitors and by no other person or persons.

4. Special Condition No. (15)(a)(ii) of the Land Grant stipulates that:

The office accommodation for watchmen or caretakers or both shall not be used for any purpose other than office accommodation for watchmen or caretakers or both, who are wholly and necessarily employed on the Lot.

5. Special Condition No. (16)(a)(ii) of the Land Grant stipulates that:

The quarters for watchmen or caretakers or both shall not be used for any purpose other than the residential accommodation of watchmen or caretakers or both, who are wholly and necessarily employed within the Lot.

6. Special Condition No. (17)(a)(i) of the Land Grant stipulates that:

The office for the use of the Owners’ Corporation or the Owners’ Committee shall not be used for any purpose other than for meetings and administrative work of the Owners’ Corporation or Owners’ Committee formed or to be formed in respect of the Lot and the buildings erected or to be erected thereon.

7. Special Condition No. (23)(a)(i), (iii) and (iv) of the Land Grant stipulate that:

(i) Spaces shall be provided within the Lot to the satisfaction of the Director for the parking of motor vehicles licensed under the Road Traffic Ordinance, any regulations made thereunder and any amending legislation, and belonging to the residents of the residential units in the building or buildings erected or to be erected on the Lot and their bona fide guests, visitors or invitees (hereinafter referred to as “the Residential Parking Spaces”) at a rate specified in the Land Grant.

(iii) Additional spaces for the parking of motor vehicles licensed under the Road Traffic Ordinance, any regulations made thereunder and any amending legislation, and belonging to the bona fide guests, visitors or invitees of the residents of the building or buildings erected or to be erected on the Lot shall be provided at a rate specified in the Land Grant.

(iv) The spaces provided under sub-clauses (a)(i) (as may be varied under Special Condition No. (25) of the Land Grant) and (a)(iii) of Special Condition No. (23) shall not be used for any purpose other than those respectively stipulated therein and in particular the said spaces shall not be used for the storage, display or exhibiting of motor vehicles for sale or otherwise or for the provision of car cleaning and beauty services.

8. Special Condition No. (23)(b)(i) and (iii) of the Land Grant stipulate that:

(i) Out of the spaces provided under sub-clause (a) of Special Condition No. (23) (as may be varied under Special Condition No. (25) of the Land Grant), the Grantee shall reserve and designate spaces for the parking of motor vehicles by disabled persons as defined in the Road Traffic Ordinance, any regulations made thereunder and any amending legislation, at a rate specified in the Land Grant.

(iii) The spaces provided under sub-clause (b)(i) of Special Condition No. (23) shall not be used for any purpose other than for the parking of motor vehicles by disabled persons as defined in the Road Traffic Ordinance, any regulations made thereunder and any amending legislation, and belonging to the residents of the building or buildings erected or to be erected on the Lot and their bona fide guests, visitors or invitees and in particular the said spaces shall not be used for the storage, display or exhibiting of motor vehicles for sale or otherwise or for the provision of car cleaning and beauty services.

9. Special Condition No. (23)(c) of the Land Grant stipulates that:

(i) Spaces shall be provided within the Lot to the satisfaction of the Director for the parking of motor cycles licensed under the Road Traffic Ordinance, any regulations made thereunder and any amending legislation, and belonging to the residents of the building or buildings erected or to be erected on the Lot and their bona fide guests, visitors or invitees (hereinafter referred to as “the Motor Cycle Parking Spaces”) at a rate specified in the Land Grant.

(ii) The Motor Cycle Parking Spaces shall not be used for any purpose other than for the purpose set out in sub-clause (c)(i) of Special Condition No. (23) and in particular the said spaces shall not be used for the storage, display or exhibiting of motor vehicles for sale or otherwise or for the provision of car cleaning and beauty services.

10. Special Condition No. (24) of the Land Grant stipulates that:

(a) Spaces shall be provided within the Lot to the satisfaction of the Director for the loading and unloading of goods vehicles at a rate of one space for every 800 residential units or part thereof in the building or buildings erected or to be erected on the Lot or at such other rates as may be approved by the Director subject to a minimum of one loading and unloading space for each block of residential units erected or to be erected on the Lot, such loading and unloading space to be located adjacent to or within each block of residential units. For the purpose of sub-clause (a) of Specified Condition No. (24), detached, semi-detached and terraced house which is intended for use as single family residence shall not be regarded as a block of residential units. The decision of the Director as to whether a detached, semi-detached or terraced house constitutes or is intended as a single family residence shall be final and binding on the Grantee.

(b) Each of the spaces provided under sub-clause (a) of Special Condition No. (23) shall measure 3.5 metres in width and 11.0 metres in length with a minimum headroom of 4.7 metres. Such spaces shall not be used for any purpose other than for the loading and unloading of goods vehicles in connection with the building or buildings referred to therein.

D. The facilities that are required to be constructed and provided for the Government, or for public use

Special Condition No. (4) of the Land Grant stipulates that:

For the purpose only of carrying out the necessary works specified in Special Condition No. (3) of the Land Grant, the Grantee shall on the date of the Land Grant be granted possession of the Green Area. The Green Area shall be re-delivered to the Government on demand and in any event shall be deemed to have been re-delivered to the Government by the Grantee on the date of a letter from the Director indicating that the conditions of the Land Grant have been complied with to his satisfaction. The Grantee shall at all reasonable times while he is in possession of the Green Area allow free access over and along the Green Area for all Government and public vehicular and pedestrian traffic and shall ensure that such access shall not be interfered with or obstructed by the carrying out of the works whether under Special Condition No. (3) of the Land Grant or otherwise.

E. The grantee's obligation to lay, form or landscape any areas, or to construct or maintain any structures or facilities, within or outside that land

1. Special Condition No. (3)(a) of the Land Grant stipulates that:

The Grantee shall :

(i) within 12 calendar months from the date of the Land Grant or such other extended periods as may be approved by the Director, at his own expense, in such manner with such materials and to such standards, levels, alignment and design as the Director shall approve and in all respects to the satisfaction of the Director :

(I) lay and form that portion of future public roads shown coloured green on the plan annexed to the Land Grant (hereinafter referred to as "the Green Area"); and

(II) provide and construct such bridges, tunnels, over-passes, under-passes, culverts, viaducts, flyovers, pavements, roads or such other structures as the Director in his sole discretion may require (hereinafter collectively referred to as "the Structures")

so that building, vehicular and pedestrian traffic may be carried on the Green Area;

(ii) within 12 calendar months from the date of the Land Grant or such other extended periods as may be approved by the Director, at his own expense and to the satisfaction of the Director, surface, kerb and channel the Green Area and provide the same with such gullies, sewers, drains, fire hydrants with pipes connected to water mains, street lights, traffic signs, street furniture and road markings as the Director may require; and

(iii) maintain at his own expense the Green Area together with the Structures and all structures, surfaces, gullies, sewers, drains, fire hydrants, services, street lights, traffic signs, street furniture, road markings and plant constructed, installed and provided thereon or therein to the satisfaction of the Director until such time as possession of the Green Area has been delivered in accordance with Special Condition No. (4) of the Land Grant.

2. Special Condition No. (7) of the Land Grant stipulates that:

The Grantee shall develop the Lot by the erection thereon of a building or buildings complying in all respects with the conditions of the Land Grant and all Ordinances, bye-laws and regulations relating to building, sanitation and planning which are or may at any time be in force in Hong Kong, such building or buildings to be completed and made fit for occupation on or before the 30th day of September 2016.

3. Special Condition No. (12)(c)(ii) of the Land Grant stipulates that:

The Grantee shall at his own expense maintain the Exempted Facilities in good and substantial repair and condition and shall operate the Exempted Facilities to the satisfaction of the Director.

4. Special Condition No. (14)(c) and (d) of the Land Grant stipulate that:

(c) The Grantee shall at his own expense landscape the Lot in accordance with the approved landscape plan in all respects to the satisfaction of the Director, and no amendment, variation, alteration, modification or substitution of the approved landscape plan shall be made without the prior written consent of the Director.

(d) The Grantee shall thereafter at his own expense maintain and keep the landscaped works in a safe, clean, neat, tidy and healthy condition all to the satisfaction of the Director.

5. Special Condition No. (23)(a)(i) and (iii) of the Land Grant stipulate that:

(i) Spaces shall be provided within the Lot to the satisfaction of the Director for the parking of motor vehicles licensed under the Road Traffic Ordinance, any regulations made thereunder and any amending legislation, and belonging to the residents of the residential units in the building or buildings erected or to be erected on the Lot and their bona fide guests, visitors or invitees (hereinafter referred to as "the Residential Parking Spaces") at a rate specified in the Land Grant.

(iii) Additional spaces for the parking of motor vehicles licensed under the Road Traffic Ordinance, any regulations made thereunder and any amending legislation, and belonging to the bona fide guests, visitors or invitees of the residents of the building or buildings erected or to be erected on the Lot shall be provided at the rate specified in the Land Grant.

6. Special Condition No. (23)(b)(i) of the Land Grant stipulates that:

Out of the spaces provided under sub-clause (a) of Special Condition No. (23) (as may be varied under Special Condition No. (25) of the Land Grant), the Grantee shall reserve and designate spaces for the parking of motor vehicles by disabled persons as defined in the Road Traffic Ordinance, any regulations made thereunder and any amending legislation, at the rate specified in the Land Grant.

7. Special Condition No. (23)(c)(i) of the Land Grant stipulates that:

Spaces shall be provided within the Lot to the satisfaction of the Director for the parking of motor cycles licensed under the Road Traffic Ordinance, any regulations made thereunder and any amending legislation, and belonging to the residents of the building or buildings erected or to be erected on the Lot and their bona fide guests, visitors or invitees (hereinafter referred to as "the Motor Cycle Parking Spaces") at a rate specified in the Land Grant.

8. Special Condition No. (24)(a) of the Land Grant stipulates that:

Spaces shall be provided within the Lot to the satisfaction of the Director for the loading and unloading of goods vehicles at a rate of one space for every 800 residential units or part thereof in the building or buildings erected or to be erected on the Lot or at such other rates as may be approved by the Director subject to a minimum of one loading and unloading space for each block of residential units erected or to be erected on the Lot, such loading and unloading space to be located adjacent to or within each block of residential units. For the purpose of sub-clause (a) of Special Condition No. (24), detached, semi-detached and terraced house which is intended for use as single family residence shall not be regarded as a block of residential units. The decision of the Director as to whether a detached, semi-detached or terraced house constitutes or is intended as a single family residence shall be final and binding on the Grantee.

9. Special Condition No. (31)(b)(i) of the Land Grant stipulates that:

The Grantee shall at his own expense and in all respects to the satisfaction of the Director uphold, maintain and repair the existing track within the Pink Hatched Black Area.

10. Special Condition No. (33) of the Land Grant stipulates that:

(a) Where there is or has been any cutting away, removal or setting back of any land, or any building up or filling in or any slope treatment works of any kind whatsoever, whether with or without the prior written consent of the Director, either within the Lot or on any Government land, which is or was done for the purpose of or in connection with the formation, levelling or development of the Lot or any part thereof or any other works required to be done by the Grantee under the conditions of the Land Grant, or for any other purpose, the Grantee shall at his own expense carry out and construct such slope treatment works, retaining walls or other support, protection, drainage or ancillary or other works as shall or may then or at any time thereafter be necessary to protect and support such land within the Lot and also any adjacent or adjoining Government or leased land and to obviate and prevent any falling away, landslip or subsidence occurring thereafter. The Grantee shall at all times during the term of the Land Grant maintain at his own expense the said land, slope treatment works, retaining walls or other support, protection, drainage or ancillary or other works in good and substantial repair and condition to the satisfaction of the Director.

(b) Nothing in sub-clause (a) of Special Condition No. (33) shall prejudice the Government's rights under the conditions of the Land Grant, in particular Special Condition No. (32) of the Land Grant.

(c) In the event that as a result of or arising out of any formation, levelling, development or other works done by the Grantee or owing to any other reason, any falling away, landslip or subsidence occurs at any time, whether in or from any land, within the Lot or from any adjacent or adjoining Government or leased land, the Grantee shall at his own expense reinstate and make good the same to the satisfaction of the Director and shall indemnify the Government, its agents and contractors from and against all costs, charges, damages, demands and claims whatsoever which shall or may be made, suffered or incurred through or by reason of such falling away, landslip or subsidence.

- (d) In addition to any other rights or remedies herein provided for breach of any of the conditions of the Land Grant, the Director shall be entitled by notice in writing to call upon the Grantee to carry out, construct and maintain the said land, slope treatment works, retaining walls, or other support, protection, and drainage or ancillary or other works or to reinstate and make good any falling away, landslip or subsidence, and if the Grantee shall neglect or fail to comply with the notice to the satisfaction of the Director within the period specified therein, the Director may forthwith execute and carry out any necessary works and the Grantee shall on demand repay to the Government the cost thereof, together with any administrative or professional fees and charges.

11. Special Condition No. (35) of the Land Grant stipulates that:

Where prestressed ground anchors have been installed, upon development or redevelopment of the Lot or any part thereof, the Grantee shall at his own expense carry out regular maintenance and regular monitoring of the prestressed ground anchors throughout their service life to the satisfaction of the Director and shall supply to the Director such reports and information on all such monitoring works as the Director may from time to time in his absolute discretion require. If the Grantee shall neglect or fail to carry out the required monitoring works, the Director may forthwith execute and carry out the monitoring works and the Grantee shall on demand repay to the Government the cost thereof.

12. Special Condition No. (37) of the Land Grant stipulates that:

The Grantee shall take or cause to be taken all proper and adequate care, skill and precautions at all times, and particularly when carrying out construction, maintenance, renewal or repair work (hereinafter referred to as “the Works”), to avoid causing any damage, disturbance or obstruction to any Government or other existing drain, waterway or watercourse, water main, road, footpath, street furniture, sewer, nullah, pipe, cable, wire, utility service or any other works or installations being or running upon, over, under or adjacent to the Lot or any part thereof or the Green Area or both the Lot or any part thereof and the Green Area (hereinafter collectively referred to as “the Services”). The Grantee shall prior to carrying out any of the Works make or cause to be made such proper search and enquiry as may be necessary to ascertain the present position and levels of the Services, and shall submit his proposals for dealing with any of the Services which may be affected by the Works in writing to the Director for his approval in all respects, and shall not carry out any work whatsoever until the Director shall have given his written approval to the Works and to such aforesaid proposals. The Grantee shall comply with and at his own expense meet any requirements which may be imposed by the Director in respect of the Services in granting the aforesaid approval, including the cost of any necessary diversion, relaying or reinstatement. The Grantee shall at his own expense in all respects repair, make good and reinstate to the satisfaction of the Director any damage, disturbance or obstruction caused to the Lot or any part thereof or the Green Area or both the Lot or any part thereof and the Green Area or any of the Services in any manner arising out of the Works (except for nullah, sewer, storm-water drain or water main, the making good of which shall be carried out by the Director, unless the Director elects otherwise, and the Grantee shall pay to the Government on demand the cost of such works). If the Grantee fails to carry out any such necessary diversion, relaying, repairing, making good and reinstatement of the Lot or any part thereof or the Green Area or both the Lot or any part thereof and the Green Area or of any of the Services to the satisfaction of the Director, the Director may carry out any such diversion, relaying, repairing, making good or reinstatement as he considers necessary and the Grantee shall pay to the Government on demand the cost of such works.

13. Special Condition No. (38)(a) of the Land Grant stipulates that:

The Grantee shall construct and maintain at his own expense and to the satisfaction of the Director such drains and channels, whether within the boundaries of the Lot or on Government land, as the Director may consider necessary to intercept and convey into the nearest stream-course, catchpit, channel or Government storm-water drain all storm-water or rain-water falling or flowing on to the Lot, and the Grantee shall be solely liable for and shall indemnify the Government and its officers from and against all actions, claims and demands arising out of any damage or nuisance caused by such storm-water or rain-water.

F. The lease conditions that are onerous to a purchaser

1. Special Condition No. (4) of the Land Grant stipulates that:

For the purpose only of carrying out the necessary works specified in Special Condition No. (3) of the Land Grant, the Grantee shall on the date of the Land Grant be granted possession of the Green Area. The Green Area shall be re-delivered to the Government on demand and in any event shall be deemed to have been re-delivered to the Government by the Grantee on the date of a letter from the Director indicating that the conditions of the Land Grant have been complied with to his satisfaction. The Grantee shall at all reasonable times while he is in possession of the Green Area allow free access over and along the Green

Area for all Government and public vehicular and pedestrian traffic and shall ensure that such access shall not be interfered with or obstructed by the carrying out of the works whether under Special Condition No. (3) of the Land Grant or otherwise.

2. Special Condition No. (12) of the Land Grant stipulates that:

- (a) The Grantee may erect, construct and provide within the Lot such recreational facilities and facilities ancillary thereto (hereinafter referred to as “the Facilities”) as may be approved in writing by the Director. The type, size, design, height and disposition of the Facilities shall also be subject to the prior written approval of the Director.
- (b) For the purpose of calculating the total gross floor area and site coverage respectively stipulated in Special Condition Nos. (9)(c) and (9)(d) of the Land Grant, subject to sub-clause (d) of Special Condition No. (41) of the Land Grant, any part of the Facilities provided within the Lot in accordance with sub-clause (a) of Special Condition No. (12) which are for the common use and benefit of all the residents of the residential block or blocks erected or to be erected on the Lot and their bona fide visitors shall not be taken into account. The remaining part of the Facilities which, in the opinion of the Director, are not for such use shall be taken into account for such calculation.
- (c) In the event that any part of the Facilities is exempted from the gross floor area and site coverage calculation pursuant to sub-clause (b) of Special Condition No. (12) (hereinafter referred to as “the Exempted Facilities”) :
- (i) the Exempted Facilities shall be designated as and form part of the Common Areas referred to in Special Condition No. (20)(a)(v) of the Land Grant;
- (ii) the Grantee shall at his own expense maintain the Exempted Facilities in good and substantial repair and condition and shall operate the Exempted Facilities to the satisfaction of the Director; and
- (iii) the Exempted Facilities shall only be used by the residents of the residential block or blocks erected or to be erected on the Lot and their bona fide visitors and by no other person or persons.

3. Special Condition No. (13) of the Land Grant stipulates that:

No tree growing on the Lot or adjacent thereto shall be removed or interfered with without the prior written consent of the Director who may, in granting consent, impose such conditions as to transplanting, compensatory landscaping or replanting as he may deem appropriate.

4. Special Condition No. (27)(a) of the Land Grant stipulates that:

- (a) Notwithstanding that the conditions of the Land Grant shall have been observed and complied with to the satisfaction of the Director, the Residential Parking Spaces and the Motor Cycle Parking Spaces shall not be :
- (i) assigned except
- (I) together with undivided shares in the Lot giving the right of exclusive use and possession of a residential unit or units in the building or buildings erected or to be erected on the Lot; or
- (II) to a person who is already the owner of undivided shares in the Lot with the right of exclusive use and possession of a residential unit or units in the building or buildings erected or to be erected on the Lot; or
- (ii) underlet except to residents of the residential units in the building or buildings erected or to be erected on the Lot.

Provided that in any event not more than three in number of the total of the Residential Parking Spaces and the Motor Cycle Parking Spaces shall be assigned to the owner or underlet to the resident of any one residential unit in the building or buildings erected or to be erected on the Lot.

5. Special Condition No. (31)(b)(ii) of the Land Grant stipulates that:

The Grantee shall allow members of the public, the Director and his officers, contractors and any persons authorized by the Director with or without tools, equipment, plant, machinery or motor vehicles at all times and for all lawful purposes freely and without payment of any nature whatsoever to pass and re-pass on, along, over and through the Pink Hatched Black Area.

6. Special Condition No. (33) of the Land Grant stipulates that:

- (a) Where there is or has been any cutting away, removal or setting back of any land, or any building up or filling in or any slope treatment works of any kind whatsoever, whether with or without the prior written consent of the Director, either within the Lot or on any Government land, which is or was done for the purpose of or in connection with the formation, levelling or development of the Lot or any part thereof or any other works required to be done by the Grantee under the conditions of the Land Grant, or for any other purpose, the Grantee shall at his own expense carry out and construct such slope treatment works, retaining walls or other support, protection, drainage or ancillary or other works as shall or may then or at any time thereafter be necessary to protect and support such land within the Lot and also any adjacent or adjoining Government or leased land and to obviate and prevent any falling away, landslip or subsidence occurring thereafter. The Grantee shall at all times during the term of the Land Grant agreed to be granted maintain at his own expense the said land, slope treatment works, retaining walls or other support, protection, drainage or ancillary or other works in good and substantial repair and condition to the satisfaction of the Director.
- (b) Nothing in sub-clause (a) of Special Condition No. (33) shall prejudice the Government's rights under the conditions of the Land Grant, in particular Special Condition No. (32) of the Land Grant.
- (c) In the event that as a result of or arising out of any formation, levelling, development or other works done by the Grantee or owing to any other reason, any falling away, landslip or subsidence occurs at any time, whether in or from any land, within the Lot or from any adjacent or adjoining Government or leased land, the Grantee shall at his own expense reinstate and make good the same to the satisfaction of the Director and shall indemnify the Government, its agents and contractors from and against all costs, charges, damages, demands and claims whatsoever which shall or may be made, suffered or incurred through or by reason of such falling away, landslip or subsidence.
- (d) In addition to any other rights or remedies herein provided for breach of any of the conditions of the Land Grant, the Director shall be entitled by notice in writing to call upon the Grantee to carry out, construct and maintain the said land, slope treatment works, retaining walls, or other support, protection, and drainage or ancillary or other works or to reinstate and make good any falling away, landslip or subsidence, and if the Grantee shall neglect or fail to comply with the notice to the satisfaction of the Director within the period specified therein, the Director may forthwith execute and carry out any necessary works and the Grantee shall on demand repay to the Government the cost thereof, together with any administrative or professional fees and charges.

7. Special Condition No. (36)(a) of the Land Grant stipulates that:

In the event of earth, spoil, debris, construction waste or building materials (hereinafter referred to as "the waste") from the Lot, or from other areas affected by any development of the Lot being eroded, washed down or dumped onto public lanes or roads or into or onto road-culverts, foreshore or seabed, sewers, storm-water drains or nullahs or other Government properties (hereinafter referred to as "the Government properties"), the Grantee shall at his own expense remove the waste from and make good any damage done to the Government properties. The Grantee shall indemnify the Government against all actions, claims and demands arising out of any damage or nuisance to private property caused by such erosion, washing down or dumping.

8. Special Condition No. (37) of the Land Grant stipulates that:

The Grantee shall take or cause to be taken all proper and adequate care, skill and precautions at all times, and particularly when carrying out construction, maintenance, renewal or repair work (hereinafter referred to as "the Works"), to avoid causing any damage, disturbance or obstruction to any Government or other existing drain, waterway or watercourse, water main, road, footpath, street furniture, sewer, nullah, pipe, cable, wire, utility service or any other works or installations being or running upon, over, under or adjacent to the Lot or any part thereof or the Green Area or both the Lot or any part thereof and the Green Area (hereinafter collectively referred to as "the Services"). The Grantee shall prior to carrying out any of the Works make or cause to be made such proper search and enquiry as may be necessary to ascertain

the present position and levels of the Services, and shall submit his proposals for dealing with any of the Services which may be affected by the Works in writing to the Director for his approval in all respects, and shall not carry out any work whatsoever until the Director shall have given his written approval to the Works and to such aforesaid proposals. The Grantee shall comply with and at his own expense meet any requirements which may be imposed by the Director in respect of the Services in granting the aforesaid approval, including the cost of any necessary diversion, relaying or reinstatement. The Grantee shall at his own expense in all respects repair, make good and reinstate to the satisfaction of the Director any damage, disturbance or obstruction caused to the Lot or any part thereof or the Green Area or both the Lot or any part thereof and the Green Area or any of the Services in any manner arising out of the Works (except for nullah, sewer, storm-water drain or water main, the making good of which shall be carried out by the Director, unless the Director elects otherwise, and the Grantee shall pay to the Government on demand the cost of such works). If the Grantee fails to carry out any such necessary diversion, relaying, repairing, making good and reinstatement of the Lot or any part thereof or the Green Area or both the Lot or any part thereof and the Green Area or of any of the Services to the satisfaction of the Director, the Director may carry out any such diversion, relaying, repairing, making good or reinstatement as he considers necessary and the Grantee shall pay to the Government on demand the cost of such works.

9. Special Condition No. (42) of the Land Grant stipulates that:

No grave or columbarium shall be erected or made on the Lot, nor shall any human remains or animal remains whether in earthenware jars, cinerary urns or otherwise be interred therein or deposited thereon.

A. 發展項目所位於土地的地段編號

發展項目興建於丈量約份第124約地段第4309號(「地段」)。

B. 有關租契規定的年期

根據新批地文件第21285號(「批地文件」)規定，該地段的租期為50年，自2011年9月6日起計。

C. 適用於該土地的用途限制

1. 批地文件特別條款第(8)條規定：

該地段或其中任何部分或在其上已建或擬建的任何建築物或任何建築物之部分不准用作私人住宅以外的任何用途。

2. 批地文件特別條款第(11)條規定：

即使批地文件特別條款第(8)條對用途限制和批地文件特別條款第(9)條已批准最大樓面面積及上蓋面積，承批人可使用按批地文件的規定在該地段已建或擬建的建築物部分和該地段的任何部分上已建的臨時獨立建築物作為售樓處和示範單位及有關的市場推銷活動，以便出售按批地文件的規定在該地段上已建或擬建的建築物或其中任何部分，但上述售樓處和示範單位及有關的市場推銷活動的範圍及運作時間須經地政總署署長(「署長」)的預先書面批准。

3. 批地文件特別條款第(12)(c)(iii)條規定：

獲豁免設施僅供該地段上已建或擬建的住宅大廈住戶和他們的真正訪客使用，而並非其他人士使用。

4. 批地文件特別條款第(15)(a)(ii)條規定：

看更或管理員或兩者的工作場所不能用作全職或必要時聘請在該地段內工作的看更或管理員或兩者的工作場所以外的任何用途。

5. 批地文件特別條款第(16)(a)(ii)條規定：

看更或管理員或兩者的宿舍不能用作全職或必要時聘請在該地段內工作的看更或管理員或兩者的宿舍以外的任何用途。

6. 批地文件特別條款第(17)(a)(i)條規定：

業主立案法團或業主委員會使用的辦事處不能用作該地段和在其上已建或擬建的建築物所成立或擬成立的業主立案法團或業主委員會的會議及行政工作以外的任何用途。

7. 批地文件特別條款第(23)(a)(i)、(iii)及(iv)條規定：

(i) 必須按批地文件指定的比率，在該地段內提供車位作停泊屬於該地段已建或擬建的住宅單位住戶和他們的真正來賓、訪客或獲邀請人按《道路交通條例》、其下的任何規例及任何修訂法例領有車牌的車輛(以下簡稱「住宅車位」)之用途，使署長滿意。

(iii) 必須按批地文件指定的比率，提供額外之車位作停泊屬於該地段已建或擬建的住宅單位住戶的真正來賓、訪客或獲邀請人按《道路交通條例》、其下的任何規例及任何修訂法例領有車牌的車輛之用途。

(iv) 按特別條款第(23)條第(a)(i)項(可按批地文件特別條款第(25)條作出修訂)和第(a)(iii)項提供的車位不能用作該條款指定以外的任何其他用途，特別是該等車位不能用作儲存、陳列或展示車輛作出售或其他用途或用作洗車或車輛美容服務。

8. 批地文件特別條款第(23)(b)(i)和(iii)條規定：

(i) 在按特別條款第(23)條第(a)項(可按批地文件特別條款第(25)條作出修訂)提供的車位中，承

批人須按批地文件指定的比率，保留與指定車位供《道路交通條例》、其下的任何規例及任何修訂法例界定的殘疾人士停泊車輛。

(iii) 按特別條款第(23)條第(b)(i)項提供的車位不能用作停泊屬於該地段已建或擬建的住宅單位住戶，按《道路交通條例》、其下的任何規例及任何修訂法例界定的殘疾人士停泊車輛以外的任何其他用途，特別是該等車位不能用作儲存、陳列或展示車輛作出售或其他用途或用作洗車或車輛美容服務。

9. 批地文件特別條款第(23)(c)條規定：

(i) 必須按批地文件指定的比率，在該地段內提供車位作停泊屬於該地段已建或擬建的住宅單位住戶和他們的真正來賓、訪客或獲邀請人按《道路交通條例》、其下的任何規例及任何修訂法例領有車牌的電單車(以下簡稱「電單車車位」)之用途，使署長滿意。

(ii) 按特別條款第(23)條第(c)(i)項提供的電單車車位不能用作該條款指定以外的任何其他用途，特別是該等車位不能用作儲存、陳列或展示電單車作出售或其他用途或用作洗車或車輛美容服務。

10. 批地文件特別條款第(24)條規定：

(a) 必須按該地段已建或擬建的建築物每800個住宅單位或其中部分一個裝卸區的比率或署長可批准的其他比率(惟在該地段已建或擬建的每座住宅單位大廈須有一個裝卸區)，在該地段內提供裝卸區作裝卸貨車之用途，使署長滿意。該裝卸區須設在每座住宅單位大廈毗鄰或之內。在特別條款第(24)條第(a)項中，擬供單一家庭居住的獨立屋、半獨立屋及排屋不能視為一座住宅單位大廈。署長對一座獨立屋、半獨立屋或排屋是否構成或擬供單一家庭居住的決定是最終決定及約束承批人。

(b) 按特別條款第(23)條第(a)項提供的裝卸區尺寸為：3.5米闊 × 11.0米長 × 至少4.7米淨空高度。該等裝卸區不能用作該條款提及有關建築物的貨車裝卸以外的任何用途。

D. 需要興建及提供給政府或公眾使用的設施

批地文件特別條款第(4)條規定

僅為了進行特別條款第(3)條指定的必要工程，承批人於本批地文件之日獲授予綠色範圍的管有權並須在要求時交還予政府。在任何情況下，於署長致函予承批人當日，證明已履行批地文件的規定，使他滿意，即視作承批人已交還綠色範圍予政府。承批人須在他管有綠色範圍期間，允許所有政府和公共車輛及行人在合理時間內自由出入綠色範圍並確保不受到按批地文件特別條款第(3)條或其他規定進行的工程之干涉或阻礙。

E. 承批人在該土地內外鋪設、塑造或作環境美化的任何範圍或興建或維持任何構築物或設施的責任

1. 批地文件特別條款第(3)(a)條規定：

承批人須：

(i) 於批地文件之日起12個曆月內或署長可批准的其他延長時期內，按署長批准的方式、材料、標準、水平、定位及設計自費進行下列工程，在一切方面使署長滿意：

(I) 鋪設及塑造批地文件附錄的圖則上以綠色顯示未來公共道路部份(以下簡稱「綠色範圍」)；及

(II) 按署長自行酌情要求，提供及建造指定橋樑、隧道、立交橋、地下通道、暗渠、高架橋、天橋、行人路、道路或其他指定構築物(以下簡稱「構築物」)

使建築物、車輛及行人的交通可在綠色範圍上進行；

(ii) 於批地文件之日起12個曆月內或署長可批准的其他延長時期內自費以署長滿意的方式在綠色範圍鋪設地面、路邊石及渠道，並按署長可能要求為此等設施提供溝渠、污水渠、排水渠、消防栓與連接至總水管的水管、街燈、交通標誌、街道設施及道路標記；及

(iii) 自費保養綠色範圍連同構築物以及興建、設置及提供在該範圍之上或之內所有構築物、路面、溝渠、污水渠、排水渠、消防栓、服務、街燈、交通標誌、街道設施、道路標記及植物，使署長滿意，直至按批地文件特別條款第(4)條指定交還綠色範圍的管有權為止。

2. 批地文件特別條款第(7)條規定：

承批人須開發該地段，在該地段上興建建築物並於2016年9月30日或之前完工和使其適合佔用，在一切方面符合批地文件及目前或任何時候在香港實施的有關建築、衛生及規劃之一切法例、附例及規例。

3. 批地文件特別條款第(12)(c)(ii)條規定：

承批人須自費保養獲豁免設施處於修繕妥當的狀態並操作獲豁免設施，使署長滿意。

4. 批地文件特別條款第(14)(c)和(d)條規定：

(c) 承批人須按經批准圖則自費美化該地段，在一切方面使署長滿意。未經署長的預先書面同意，不能修訂、改變、更改、修改或代替經批准園藝圖。

(d) 承批人須在其後自費保養及保持園藝工程處於安全、井然、整潔及健康狀態，使署長滿意。

5. 批地文件特別條款第(23)(a)(i)和(iii)條規定：

(i) 必須按批地文件指定的比率，在該地段內提供車位作停泊屬於該地段已建或擬建的住宅單位住戶和他們的真正來賓、訪客或獲邀請人按《道路交通條例》、其下的任何規例及任何修訂法例領有車牌的車輛(以下簡稱「住宅車位」)之用途，使署長滿意。

(iii) 必須按批地文件指定的比率，提供額外之車位作停泊屬於該地段已建或擬建的住宅單位住戶的真正來賓、訪客或獲邀請人按《道路交通條例》、其下的任何規例及任何修訂法例領有車牌的車輛之用途。

6. 批地文件特別條款第(23)(b)(i)條規定：

在按特別條款第(23)條第(a)項(可按批地文件特別條款第(25)條作出修訂)提供的車位中，承批人須按批地文件指定的比率，保留與指定車位供《道路交通條例》、其下的任何規例及任何修訂法例界定的殘疾人士停泊車輛。

7. 批地文件特別條款第(23)(c)(i)條規定：

(i) 必須按批地文件指定的比率，在該地段內提供車位作停泊屬於該地段已建或擬建的住宅單位住戶和他們的真正來賓、訪客或獲邀請人按《道路交通條例》、其下的任何規例及任何修訂法例領有車牌的電單車(以下簡稱「電單車車位」)之用途，使署長滿意。

8. 批地文件特別條款第(24)(a)條規定：

必須按該地段已建或擬建的建築物每800個住宅單位或其中部分一個裝卸區的比率或署長可批准的其他比率(惟在該地段已建或擬建的每座住宅單位大廈須有一個裝卸區)，在該地段內提供裝卸區作裝卸貨車之用途，使署長滿意。該裝卸區須設在每座住宅單位大廈毗鄰或之內。在特別條款第24條第(a)項中，擬供單一家庭居住的獨立屋、半獨立屋及排屋不能視為一座住宅單位大廈。署長對一座獨立屋、半獨立屋或排屋是否構成或擬供單一家庭居住的決定是最終決定及約束承批人。

9. 批地文件特別條款第(31)(b)(i)條規定：

承批人須自費維護、保養及維修粉紅色加黑斜線範圍內的現有路徑，在一切方面使署長滿意。

10. 批地文件特別條款第(33)條規定：

(a) 如果任何土地需要或已經被挖除、移除或移後或堆積或堆填或進行任何類型的斜坡護土工程，不論是否經署長事先書面同意，亦不論是在該地段內或任何政府土地內，其目的旨在構

建、平整或開發該地段或其中任何部分或承批人按批地文件條款需要進行的任何其他工程，或作任何其他用途，承批人須自費進行與建造其時或其後隨時必要的該等斜坡處理工程、護土牆或其他承托物、保護物、排水或輔助工程或其他工程，以便保護與承托該地段和任何毗鄰或毗連政府土地或出租土地內的泥土，避免與防止今後發生任何塌方、山泥傾瀉或地陷。承批人須在批地文件授予的租期期間自費保養該土地、斜坡處理工程、護土牆或其他承托物、保護物、排水或輔助工程或其他工程處於修繕妥當的狀態，使署長滿意。

(b) 特別條款第(33)條第(a)項不能影響本文件，特別是批地文件特別條款第(32)條賦予政府的權利。

(c) 倘若因為任何構建、平整、開發或承批人進行其他工程或任何其他原因造成任何時候發生塌方、山泥傾瀉或地陷，不論發生在或來自該地段任何土地或任何毗鄰或毗連政府土地或出租土地，承批人須自費進行修復或修補，使署長滿意並對上述塌方、山泥傾瀉或地陷造成政府、他的代理人及承建商承受、遭受或產生一切費用、收費、損害賠償、要求及索償向彼等作出彌償。

(d) 除了批地文件規定對違反該等條件的任何其他權利或補救外，署長有權發出書面通知要求承批人進行、修建及保養該土地、斜坡處理工程、護土牆或其他承托物、保護物及排水或輔助工程或其他工程或修復與修補任何塌方、山泥傾瀉或地陷。如果承批人無理會或未能在通知指定的時期內執行該通知要求，使署長滿意，署長可立即執行與進行任何必要工程。承批人須在要求時歸還政府因此產生的費用。

11. 批地文件特別條款第(35)條規定：

如果在開發或重新開發該地段或其中任何部分時已安裝預應力地樁，承批人須在預應力地樁的服務年限期間定期保養與檢查預應力地樁，使署長滿意並在署長不時自行酌情要求時提供上述檢驗工程的報告和資料給署長。如果承批人無理會或未能在通知指定的時期內執行該通知要求，署長可立即執行與進行任何必要工程。承批人須在要求時歸還政府因此產生的費用。

12. 批地文件特別條款第(37)條規定：

承批人須在任何時候，特別是在任何建築、保養、翻新或維修工程(以下簡稱「工程」)期間，採取或促使他人採取一切適當及充分的關注、技巧及預防措施，避免對該土地或其中任何部分或綠色範圍或兩者之上、上面、之下或毗鄰的任何政府擁有或其他的現有排水渠、水路、水道、總水喉、道路、行人路、行人徑、街道設施、污水渠、明渠、管道、電纜、電線、公用事業服務或任何其他工程或裝置(以下合稱「服務」)造成任何損壞、干擾或阻塞。承批人在進行上述任何工程之前須進行或促使他人進行適當的勘測及必要的了解，確定任何服務的現況及水平標準，並提交處理任何服務一切方面的書面建議給署長，供他審批，但必須在取得署長對上述工程及建議作出的書面批准後才能進行該等工程。承批人須履行署長對服務的任何要求和承擔符合該等要求支出的費用，包括必要的改道、重鋪或還原工程的費用。承批人必須自費在一切方面維修、修補及修復以任何方式進行上述工程對該土地或綠色範圍或兩者或該等服務造成的任何損壞、干擾或阻塞(除了明渠、污水渠、雨水渠、排水渠或總水喉須由署長負責修復，除非他另作選擇，承批人須在要求時向政府支付該等工程的費用)，使署長滿意。如果承批人未能對該土地或綠色範圍或他們全部或該等服務進行上述必要的改道、重鋪、修修、修補及還原工程，使署長滿意，署長可進行他認為必要的上述改道、重鋪、維修、修復或還原工程，承批人須在要求時向政府支付該等工程的費用。

13. 批地文件特別條款第(38)(a)條規定：

承批人須自費建造及保養該地段邊界內或署長認為必要的政府土地內的排水渠及渠道，並使署長滿意，以便截流與引導該地段的一切雨洪或雨水到最接近的河道、集水溝、渠道或政府雨水渠。承批人須對上述雨洪或雨水造成的任何損壞或滋擾而導致的一切訴訟、索償及要求自行負責並向政府及其官員作出彌償。

F. 對購買人造成負擔的租用條件

1. 批地文件特別條款第(12)條規定：

(a) 承批人可在該地段內搭建、建築及提供署長書面批准的該等康樂設施及其輔助設施(以下簡稱「設施」)。設施的類型、面積、設計、高度及布局須經署長預先書面批准。

- (b) 為了計算批地文件特別條款第9(c)和9(d)條指定的總建築面積和上蓋面積，除了批地條件特別條款第(41)條第(d)項規定外，按批地條件特別條款第(12)條第(a)項規定在該地段內提供給該地段已建或擬建住宅大廈所有住戶和他們的真正訪客共同使用及享用的設施任何部分毋須列入計算，設施的餘下部分若署長認為並非作該用途，則應列入上述計算。
- (c) 倘若按批地條件特別條款第(12)條第(b)項規定豁免設施的任何部分列入計算總建築面積及上蓋面積(以下簡稱為「獲豁免設施」)：
- (i) 獲豁免設施應指定為批地文件特別條款第(20)(a)(v)條提及的公用地方之部分；
- (ii) 承批人須自費保養獲豁免設施處於修繕妥當的狀態並操作獲豁免設施，使署長滿意。
- (iii) 獲豁免設施僅能由該地段已建或擬建的住宅大廈住戶和他們的真正訪客使用，並非其他人士使用。
2. 批地文件特別條款第(4)條規定：
- 僅為了進行特別條款第(3)條指定的必要工程，承批人於本批地文件之日獲授予綠色範圍的管有權並須在要求時交還予政府。在任何情況下，於署長致函予承批人當日，證明已履行批地文件的規定，使他滿意，即視作承批人已交還綠色範圍予政府。承批人須在他管有綠色範圍期間，允許所有政府和公共車輛及行人在合理時間內自由出入綠色範圍並確保不受到按批地文件特別條款第(3)條或其他規定進行的工程之干涉或阻礙。
3. 批地文件特別條款第(13)條規定：
- 未經署長事先書面同意，不得移除或干擾該地段或毗連範圍內的樹木。署長在發出書面同意時，可施加他認為合適的條件，以對於樹木進行移植、補償性景觀美化工程或再植。
4. 批地文件特別條款第(27)(a)條規定：
- (a) 即使已遵守與履行批地文件的規定，住宅車位及住宅電單車車位不能
- (i) 轉讓，除非
- (I) 連同該地段的不可分割份數及獨家使用及管有該地段已建或擬建的大廈住宅單位的權利；或
- (II) 給已經是該地段的不可分割份數及獨家使用及管有該地段已建或擬建的大廈住宅單位的權利的業主之人士；或
- (ii) 分租，除非給該地段已建或擬建的大廈住宅單位的住戶，
- 但是在任何情況下，不得轉讓或分租超過3個住宅車位和電單車車位給予該地段已建或擬建大廈任何一個住宅單位的業主或住戶。
5. 批地文件特別條款第(31)(b)(ii)條規定：
- 承批人須允許公眾人士、署長及他的官員、承建商及署長授權的任何人士為了一切合法目的自由及毋須作出任何性質的付款於任何時間內帶上或不帶上工具、設備、機械、機器或車輛經過及再經過粉紅色加黑斜線範圍。
6. 批地文件特別條款第(33)條規定：
- (a) 如果任何土地需要或已經被挖除、移除或移後或堆積或堆填或進行任何類型的斜坡護土工程，不論是否經署長事先書面同意，亦不論是在該地段內或任何政府土地內，其目的旨在構建、平整或開發該地段或其中任何部分或承批人按批地文件條款需要進行的任何其他工程，或作任何其他用途，承批人須自費進行與建造其時及其後隨時必要的該等斜坡處理工程、護土牆或其他承托物、保護物、排水或輔助工程或其他工程，以便保護與承托該地段和任何毗鄰或毗連政府土地或出租土地內的泥土，避免與防止今後發生任何塌方、山泥傾瀉或地陷。

承批人須在批地文件授予的租期期間自費保養該土地、斜坡處理工程、護土牆或其他承托物、保護物、排水或輔助工程或其他工程處於修繕妥當的狀態，使署長滿意。

- (b) 特別條款第(33)條第(a)項不能影響本文件，特別是批地文件特別條款第(32)條賦予政府的權利。
- (c) 倘若因為任何構建、平整、開發或承批人進行其他工程或任何其他原因造成任何時候發生塌方、山泥傾瀉或地陷，不論發生在或來自該地段任何土地或任何毗鄰或毗連政府土地或出租土地，承批人須自費進行修復或修補，使署長滿意並對上述塌方、山泥傾瀉或地陷造成政府、他的代理人及承建商承受、遭受或產生一切費用、收費、損害賠償、要求及索償向彼等作出彌償。
- (d) 除了批地文件規定對違反該等條件的任何其他權利或補救外，署長有權發出書面通知要求承批人進行、修建及保養該土地、斜坡處理工程、護土牆或其他承托物、保護物及排水或輔助工程或其他工程或修復與修補任何塌方、山泥傾瀉或地陷。如果承批人不理會或未能在通知指定的時期內執行該通知要求，使署長滿意，署長可立即執行與進行任何必要工程。承批人須在要求時歸還政府因此產生的費用連同任何行政費或專業費用及開支。
7. 特別條款第(36)(a)條規定：
- 倘若從該地段或開發該地段所影響的其他區域腐蝕、沖洗或棄置泥土、廢石方、瓦礫、建築廢料或建材(以下簡稱「廢料」)到公共行人徑、道路或路渠、海灘、海底、污水渠、雨水渠、排水渠或溝渠或其他政府物業(以下簡稱「政府物業」)，承批人須自費清理該等廢料並修復對政府物業造成的損壞。承批人須對上述腐蝕、清洗或棄置對私人物業造成的任何損壞或干擾所引致的一切訴訟、索償及要求彌償政府。
8. 特別條款第(37)條規定：
- 承批人須在任何時候，特別是在任何建築、保養、翻新或維修工程(以下簡稱「工程」)期間，採取或促使他人採取一切適當及充分的關注、技巧及預防措施，避免對該土地或其中任何部分或綠色範圍或兩者之上、上面、之下或毗鄰的任何政府擁有或其他的現有排水渠、水路、水道、總水喉、道路、行人路、行人徑、街道設施、污水渠、明渠、管道、電纜、電線、公用事業服務或任何其他工程或裝置(以下統稱「服務」)造成任何損壞、干擾或阻塞。承批人在進行上述任何工程之前須進行或促使他人進行適當的勘測及必要的了解，確定任何服務的現況及水平標準，並提交處理任何服務一切方面的書面建議給署長，供他審批，但必須在取得署長對上述工程及建議作出的書面批准後才能進行該等工程。承批人須履行署長對服務的任何要求和承擔符合該等要求支出的費用，包括必要的改道、重鋪或還原工程的費用。承批人必須自費在一切方面維修、修補及修復以任何方式進行上述工程對該土地或綠色區域或他們全部或該等服務造成的任何損壞、干擾或阻塞(除了明渠、污水渠、雨水渠、排水渠或總水喉須由署長負責修復，除非他另作選擇，承批人須在要求時向政府支付該等工程的費用)，使署長滿意。如果承批人未能對該土地或綠色區域或他們全部或該等服務進行上述必要的改道、重鋪、維修、修補及還原工程，使署長滿意，署長可進行他認為必要的上述改道、重鋪、維修、修復或還原工程，承批人須在要求時向政府支付該等工程的費用。
9. 批地文件特別條款第(42)條規定：
- 不能在該地段搭建或製作墳墓或骨灰龕，亦不能在其內或其上用泥壇、骨灰盒或其他形式埋葬或存放人類遺骸或動物遺骸。

A. Facilities that are required under the land grant to be constructed and provided for the Government, or for public use

1. The Green Area (the “Green Area”) as referred to in Special Condition No.(3) of the Land Grant.

(a) Provisions of the Land Grant that concerns the Green Area

Special Condition Nos. (3), (4), (5) and (6) of the Land Grant stipulate that:-

(3) (a) The Purchaser shall :

(i) within 12 calendar months from the date of this Agreement or such other extended periods as may be approved by the Director, at his own expense, in such manner with such materials and to such standards, levels, alignment and design as the Director shall approve and in all respects to the satisfaction of the Director :

(I) lay and form that portion of future public roads shown coloured green on the plan annexed hereto (hereinafter referred to as “the Green Area”); and

(II) provide and construct such bridges, tunnels, over-passes, under-passes, culverts, viaducts, flyovers, pavements, roads or such other structures as the Director in his sole discretion may require (hereinafter collectively referred to as “the Structures”)

so that building, vehicular and pedestrian traffic may be carried on the Green Area;

(ii) within 12 calendar months from the date of this Agreement or such other extended periods as may be approved by the Director, at his own expense and to the satisfaction of the Director, surface, kerb and channel the Green Area and provide the same with such gullies, sewers, drains, fire hydrants with pipes connected to water mains, street lights, traffic signs, street furniture and road markings as the Director may require; and

(iii) maintain at his own expense the Green Area together with the Structures and all structures, surfaces, gullies, sewers, drains, fire hydrants, services, street lights, traffic signs, street furniture, road markings and plant constructed, installed and provided thereon or therein to the satisfaction of the Director until such time as possession of the Green Area has been delivered in accordance with Special Condition No. (4) hereof.

(b) In the event of the non-fulfilment of the Purchaser’s obligations under sub-clause (a) of this Special Condition, the Government may carry out the necessary works at the cost of the Purchaser who shall pay to the Government on demand a sum equal to the cost thereof, such sum to be determined by the Director whose determination shall be final and binding upon the Purchaser.

(c) The Government shall have no liability in respect of any loss, damage, nuisance or disturbance whatsoever caused to or suffered by the Purchaser or any other person whether arising out of or incidental to the fulfilment of the Purchaser’s obligations under sub-clause (a) of this Special Condition or the exercise of the rights by the Government under sub-clause (b) of this Special Condition or otherwise, and no claim for compensation or otherwise shall be made against the Government by the Purchaser in respect of any such loss, damage, nuisance or disturbance.

(4) For the purpose only of carrying out the necessary works specified in Special Condition No. (3) hereof, the Purchaser shall on the date of this Agreement be granted possession of the Green Area. The Green Area shall be re-delivered to the Government on demand and in any event shall be deemed to have been re-delivered to the Government by the Purchaser on the date of a letter from the Director indicating that these Conditions have been complied with to his satisfaction. The Purchaser shall at all reasonable times while he is in possession of the Green Area allow free access over and along the Green Area for all Government and public vehicular and pedestrian traffic and shall ensure that such access shall not be interfered with or obstructed by the carrying out of the works whether under Special Condition No. (3) hereof or otherwise.

(5) The Purchaser shall not without the prior written consent of the Director use the Green Area for the purpose of storage or for the erection of any temporary structure or for any purposes other than the carrying out of the works specified in Special Condition No. (3) hereof.

(6) (a) The Purchaser shall at all reasonable times while he is in the possession of the Green Area :

(i) permit the Government, the Director and his officers, contractors and agents and any persons authorized by the Director the right of ingress, egress and regress to, from and through the lot and the Green Area for the purpose of inspecting, checking and supervising any works to be carried out in compliance with Special Condition No. (3)(a) hereof and the carrying out, inspecting, checking and supervising of the works under Special Condition No. (3)(b) hereof and any other works which the Director may consider necessary in the Green Area;

(ii) permit the Government and the relevant public utility companies authorized by the Government the right of ingress, egress and regress to, from and through the lot and the Green Area as the Government or the relevant public utility companies may require for the purpose of any works to be carried out in, upon or under the Green Area or any adjoining land including but not limited to the laying and subsequent maintenance of all pipes, wire, conduits, cable-ducts and other conducting media and ancillary equipment necessary for the provision of telephone, electricity, gas (if any) and other services intended to serve the lot or any adjoining or neighbouring land or premises, and the Purchaser shall co-operate fully with the Government and also with the relevant public utility companies duly authorized by the Government on all matters relating to any of the aforesaid works to be carried out within the Green Area; and

(iii) permit the officers of the Water Authority and such persons as may be authorized by them the right of ingress, egress and regress to, from and through the lot and the Green Area as the officers of the Water Authority or such authorized persons may require for the purpose of carrying out any works in relation to the operation, maintenance, repairing, replacement and alteration of any other waterworks installations within the Green Area.

(b) The Government, the Director and his officers, contractors and agents and any persons or public utility companies duly authorized under sub-clause (a) of this Special Condition shall have no liability in respect of any loss, damage, nuisance or disturbance whatsoever caused to or suffered by the Purchaser or any other person arising out of or incidental to the exercise of the rights by the Government, the Director and his officers, contractors and agents, and any persons or public utility companies duly authorized under sub-clause (a) of this Special Condition.

(b) Provisions of the deed of mutual covenant (“DMC”) that concerns the Green Area

Paragraph (c) of Part B of the Second Schedule to the DMC stipulates that:

The right and privilege of the members of the public, the Director of Lands and his officers, contractors and any persons authorised by the Director as set out in Special Condition No. (31)(b)(ii) of the Government Grant over the Pink Hatched Black Area (as defined in Special Condition No. (31)(a) of the Government Grant) until the Green Area (as defined in Special Condition No. (3)(a)(i)(I) of the Government Grant) shall be formed and re-delivered to the Government in accordance with Special Condition No. (4) of the Government Grant. The Green Area was re-delivered to the Government with effect from 15th April 2013 under Government in accordance with Special Condition No. (4) of the Government Grant.

(c) The general public has the right to use the Green Area in accordance with the Land Grant.

B. Facilities that are required under the land grant to be managed, operated or maintained for public use at the expense of the owners of the residential properties in the Development

1. The Green Area.

(a) Provisions of the Land Grant that concerns the Green Area

Special Condition Nos. (3), (4), (5) and (6) of the Land Grant stipulate that:

(3) (a) The Purchaser shall :

(i) within 12 calendar months from the date of this Agreement or such other extended periods as may be approved by the Director, at his own expense, in such manner with such materials and to

such standards, levels, alignment and design as the Director shall approve and in all respects to the satisfaction of the Director :

- (I) lay and form that portion of future public roads shown coloured green on the plan annexed hereto (hereinafter referred to as “the Green Area”); and
- (II) provide and construct such bridges, tunnels, over-passes, under-passes, culverts, viaducts, flyovers, pavements, roads or such other structures as the Director in his sole discretion may require (hereinafter collectively referred to as “the Structures”)

so that building, vehicular and pedestrian traffic may be carried on the Green Area;

- (ii) within 12 calendar months from the date of this Agreement or such other extended periods as may be approved by the Director, at his own expense and to the satisfaction of the Director, surface, kerb and channel the Green Area and provide the same with such gullies, sewers, drains, fire hydrants with pipes connected to water mains, street lights, traffic signs, street furniture and road markings as the Director may require; and
- (iii) maintain at his own expense the Green Area together with the Structures and all structures, surfaces, gullies, sewers, drains, fire hydrants, services, street lights, traffic signs, street furniture, road markings and plant constructed, installed and provided thereon or therein to the satisfaction of the Director until such time as possession of the Green Area has been delivered in accordance with Special Condition No. (4) hereof.

- (b) In the event of the non-fulfilment of the Purchaser’s obligations under sub-clause (a) of this Special Condition, the Government may carry out the necessary works at the cost of the Purchaser who shall pay to the Government on demand a sum equal to the cost thereof, such sum to be determined by the Director whose determination shall be final and binding upon the Purchaser.
- (c) The Government shall have no liability in respect of any loss, damage, nuisance or disturbance whatsoever caused to or suffered by the Purchaser or any other person whether arising out of or incidental to the fulfilment of the Purchaser’s obligations under sub-clause (a) of this Special Condition or the exercise of the rights by the Government under sub-clause (b) of this Special Condition or otherwise, and no claim for compensation or otherwise shall be made against the Government by the Purchaser in respect of any such loss, damage, nuisance or disturbance.

- (4) For the purpose only of carrying out the necessary works specified in Special Condition No. (3) hereof, the Purchaser shall on the date of this Agreement be granted possession of the Green Area. The Green Area shall be re-delivered to the Government on demand and in any event shall be deemed to have been re-delivered to the Government by the Purchaser on the date of a letter from the Director indicating that these Conditions have been complied with to his satisfaction. The Purchaser shall at all reasonable times while he is in possession of the Green Area allow free access over and along the Green Area for all Government and public vehicular and pedestrian traffic and shall ensure that such access shall not be interfered with or obstructed by the carrying out of the works whether under Special Condition No. (3) hereof or otherwise.

- (5) The Purchaser shall not without the prior written consent of the Director use the Green Area for the purpose of storage or for the erection of any temporary structure or for any purposes other than the carrying out of the works specified in Special Condition No. (3) hereof.

- (6) (a) The Purchaser shall at all reasonable times while he is in the possession of the Green Area :

- (i) permit the Government, the Director and his officers, contractors and agents and any persons authorized by the Director the right of ingress, egress and regress to, from and through the lot and the Green Area for the purpose of inspecting, checking and supervising any works to be carried out in compliance with Special Condition No. (3)(a) hereof and the carrying out, inspecting, checking and supervising of the works under Special Condition No. (3)(b) hereof and any other works which the Director may consider necessary in the Green Area;
- (ii) permit the Government and the relevant public utility companies authorized by the Government the right of ingress, egress and regress to, from and through the lot and the Green Area as the Government or the relevant public utility companies may require for the purpose of any works to be carried out in, upon or under the Green Area or any adjoining land including but not limited to the laying and subsequent maintenance of all pipes, wire, conduits, cable-ducts and other conducting media and ancillary equipment necessary for the provision of telephone, electricity,

gas (if any) and other services intended to serve the lot or any adjoining or neighbouring land or premises, and the Purchaser shall co-operate fully with the Government and also with the relevant public utility companies duly authorized by the Government on all matters relating to any of the aforesaid works to be carried out within the Green Area; and

- (iii) permit the officers of the Water Authority and such persons as may be authorized by them the right of ingress, egress and regress to, from and through the lot and the Green Area as the officers of the Water Authority or such authorized persons may require for the purpose of carrying out any works in relation to the operation, maintenance, repairing, replacement and alteration of any other waterworks installations within the Green Area.

- (b) The Government, the Director and his officers, contractors and agents and any persons or public utility companies duly authorized under sub-clause (a) of this Special Condition shall have no liability in respect of any loss, damage, nuisance or disturbance whatsoever caused to or suffered by the Purchaser or any other person arising out of or incidental to the exercise of the rights by the Government, the Director and his officers, contractors and agents and any persons or public utility companies duly authorized under sub-clause (a) of this Special Condition.

- (b) Provisions of the DMC that concerns the Green Area

Paragraph (c) of Part B of the Second Schedule to the DMC stipulates that:

The right and privilege of the members of the public, the Director of Lands and his officers, contractors and any persons authorised by the Director as set out in Special Condition No.(31)(b)(ii) of the Government Grant over the Pink Hatched Black Area (as defined in Special Condition No. (31)(a) of the Government Grant) until the Green Area (as defined in Special Condition No. (3)(a)(i)(I) of the Government Grant) shall be formed and re-delivered to the Government in accordance with Special Condition No. (4) of the Government Grant. The Green Area was re-delivered to the Government with effect from 15th April 2013 under Government in accordance with Special Condition No. (4) of the Government Grant.

- (c) The general public has the right to use the Green Area in accordance with the Land Grant.
- (d) The Green Area is required to be managed, operated or maintained at the expense of the owners of the residential properties in the Development. The owners are required to meet a proportion of the expense of managing, operating or maintaining the Green Area through the management expenses apportioned to the residential properties concerned.

- 2. The existing track (the “Existing Track”) referred to in Special Condition No.(31) of the Land Grant.

- (a) Provisions of the Land Grant that concerns the Existing Track

Special Condition No. (31) of the Land Grant stipulate that:

- (a) The Purchaser acknowledges that as at the date of this Agreement there is an existing track over that portion of the lot shown coloured pink hatched black on the plan annexed hereto (hereinafter referred to as “the Pink Hatched Black Area”).

- (b) Unless and until the Green Area has been formed in accordance with Special Condition No. (3) hereof and re-delivered to the Government in accordance with Special Condition No. (4) hereof :

- (i) the Purchaser shall at his own expense and in all respects to the satisfaction of the Director uphold, maintain and repair the existing track within the Pink Hatched Black Area; and
- (ii) the Purchaser shall allow members of the public, the Director and his officers, contractors and any persons authorized by the Director with or without tools, equipment, plant, machinery or motor vehicles at all times and for all lawful purposes freely and without payment of any nature whatsoever to pass and repass on, along, over and through the Pink Hatched Black Area.

- (c) In the event of the non-fulfilment of the Purchaser’s obligations under subclause (b)(i) of this Special Condition, the Government may carry out the necessary maintenance or repair works at the cost of the Purchaser who shall pay to the Government on demand a sum equal to the cost thereof, such sum to be determined by the Director whose determination shall be final and binding upon the Purchaser. For the

purpose of carrying out the works aforesaid, the Government, the Director and his officers, contractors, agents and workmen and other duly authorized personnel shall have a free and uninterrupted right at all reasonable times to enter the lot or any part thereof.

(d) The Government, the Director and his officers, contractors, agents and workmen and other duly authorized personnel shall have no liability in respect of any loss, damage, nuisance or disturbance whatsoever caused to or suffered by the Purchaser or any other person whether arising out of or incidental to the fulfilment of the Purchaser's obligations under sub-clause (b) of this Special Condition or the exercise of the rights by the Government, the Director and his officers, contractors, agents and workmen and other duly authorized personnel under sub-clause (c) of this Special Condition or otherwise, and no claim for compensation or otherwise shall be made by the Purchaser against the Government, the Director and his officers, contractors, agents and workmen and other duly authorized personnel in respect of any such loss, damage, nuisance or disturbance.

(e) No parking spaces, lay-bys or loading and unloading spaces shall be allowed on, over, under, above, below or within the Pink Hatched Black Area.

(b) Provisions of the DMC that concerns the Existing Track

Paragraph (c) of Part B of the Second Schedule to the DMC stipulates that:

The right and privilege of the members of the public, the Director of Lands and his officers, contractors and any persons authorised by the Director as set out in Special Condition No.(31)(b)(ii) of the Government Grant over the Pink Hatched Black Area (as defined in Special Condition No. (31)(a) of the Government Grant) until the Green Area (as defined in Special Condition No. (3)(a)(i)(I) of the Government Grant) shall be formed and re-delivered to the Government in accordance with Special Condition No. (4) of the Government Grant. The Green Area was re-delivered to the Government with effect from 15th April 2013 under Government in accordance with Special Condition No. (4) of the Government Grant.

(c) The general public has the right to use the Existing Track in accordance with the Land Grant.

(d) The Existing Track is required to be managed, operated or maintained at the expense of the owners of the residential properties in the Development. The owners are required to meet a proportion of the expense of managing, operating or maintaining the Existing Track through the management expenses apportioned to the residential properties concerned.

C. Open space that is required under the land grant to be managed, operated or maintained for public use at the expense of the owners of the residential properties in the Development

Not applicable.

D. Any part of the land (on which the Development is situated) that is dedicated to the public for the purposes of regulation 22(1) of the Building (Planning) Regulations (Cap.123 sub. leg. F)

Not applicable.

Note:

The Green Area had been re-delivered to the Government with effect from 15th April 2013 in accordance with Special Condition No.(4) of the Land Grant.

A. 批地文件規定須興建並提供予政府或供公眾使用的設施

1. 批地文件特別條款第(3)條提及的綠色範圍(「綠色範圍」)

(a) 批地文件對綠色範圍的規定

批地文件特別條款第(3)、(4)、(5)及(6)條規定：

(3) (a) 購買人須：

(i) 於本協議之日起12個曆月內或署長可批准的其他延長時期內，按署長批准的方式、材料、標準、水平、定位及設計自費進行下列工程，在一切方面使署長滿意：

(I) 鋪設及塑造本文附錄的圖則上以綠色顯示未來公共道路部份(以下簡稱「綠色範圍」)；及

(II) 按署長自行酌情要求，提供及建造指定橋樑、隧道、立交橋、地下通道、暗渠、高架橋、天橋、行人路、道路或其他指定構築物(以下簡稱「構築物」)

使建築物、車輛及行人的交通可在綠色範圍上進行；

(ii) 於本協議之日起12個曆月內或署長可批准的其他延長時期內自費以署長滿意的方式在綠色範圍鋪設地面、路邊石及渠道，並按署長可能要求為此等設施提供溝渠、污水渠、排水渠、消防栓與連接至總水管的水管、街燈、交通標誌、街道設施及道路標記；及

(iii) 自費保養綠色範圍連同構築物以及興建、設置及提供在該範圍之上或之內所有構築物、路面、溝渠、污水渠、排水渠、消防栓、服務、街燈、交通標誌、街道設施、道路標記及植物，使署長滿意，直至按批地文件特別條款第(4)條指定交還綠色範圍的管有權為止。

(b) 倘若購買人未能在指定的期限內履行本特別條款第(a)項規定他的責任，政府可進行必要的工程，費用由購買人承擔。購買人須在要求時向政府支付署長決定相等於該工程費用的款項，署長的決定是最終的及約束購買人。

(c) 政府對購買人履行本特別條款第(a)項規定他的責任或政府履行本特別條款第(b)項規定他的責任造成或引致購買人或其他人士蒙受任何損失、損害、滋擾、干擾毋須承擔任何責任。購買人不能就上述損失、損害、滋擾或干擾向政府索償。

(4) 僅為了進行特別條款第(3)條指定的必要工程，購買人於本協議之日獲授予綠色範圍的管有權並須在要求時交還予政府。在任何情況下，於署長致函予購買人當日，證明已履行批地文件的規定，使他滿意，即視作購買人已交還綠色範圍予政府。購買人須在他管有綠色範圍期間，允許所有政府和公共車輛及行人在合理時間內自由出入綠色範圍並確保不受到按特別條款第(3)條或其他規定進行的工程之干涉或阻礙。

(5) 未經署長的預先書面同意，購買人不得使用綠色範圍作儲物用途或搭建任何臨時構築物或任何用途，除了進行特別條款第(3)條指定的工程

(6) (a) 購買人須在管有綠色範圍期間，於任何合理時間內：

(i) 准許政府、署長及他的官員、承建商、署長授權的任何其他人士有權出入、經過及再經過該地段及綠色範圍，旨在視察、檢查及監管特別條款第(3)(a)條指定的工程和進行、檢查及監管特別條款第(3)(b)條指定的工程及署長認為有必要在綠色範圍進行的任何其他工程；

(ii) 准許政府和政府授權的有關公用事業公司在他們要求時有權出入、經過及再經過該地段及綠色範圍，旨在綠色範圍或任何毗鄰土地之內、之上或之下進

行任何工程，包括但不限於鋪設和其後保養一切管道、電線、槽、電纜槽及其他傳導媒介及輔助設備，以便提供電話、電力、煤氣(如有)及其他服務給該地段或任何毗鄰或毗連土地及物業。購買人須充分配合政府和政府正式授權的有關公用事業公司在綠色範圍內進行上述工程的一切事宜；及

(iii) 准許水務監督的官員和他們授權的其他人士在他們要求時有權出入、經過及再經過該地段及綠色範圍，旨在進行有關操作、保養、修理、更換、更改綠色範圍內的任何水務工程裝置。

(b) 政府、署長及他的官員、承建商、代理人和按本特別條款第(a)項正式授權的任何人士及公用事業公司對於政府、署長及他的官員、承建商、代理人和按本特別條款第(a)項正式授權的任何人士或公用事業公司行使該權利造成或引致購買人或任何其他人士蒙受任何損失、損害、滋擾或干擾毋須承擔任何責任。

(b) 公契(「公契」)對綠色範圍的規定

公契第二附表B部分第(c)段的規定：

公眾人士、地政總署署長及他的官員、承建商及署長授權的任何人士有權利及特權按政府批地文件特別條款第(31)(b)(ii)條使用粉紅色加黑斜線範圍(按政府批地文件特別條款第(31)(a)條界定)直至綠色範圍(按政府批地文件特別條款第(3)(a)(i)(I)條規定)按政府批地文件特別條款第(4)條塑造及交還予政府。綠色範圍已按政府批地文件特別條款第(4)條規定於2013年4月15日交還予政府。

(c) 公眾人士有權按批地文件使用綠色範圍。

B. 批地文件規定須由發展項目中的住宅物業的擁有人出資管理、營運或維持以供公眾使用的設施

1. 綠色範圍

(a) 批地文件對綠色範圍的規定

批地文件特別條款第(3)、(4)、(5)及(6)條規定：

(3) (a) 購買人須：

(i) 於批地文件之日起12個曆月內或署長可批准的其他延長時期內，按署長批准的方式、材料、標準、水平、定位及設計自費進行下列工程，在一切方面使署長滿意：

(I) 鋪設及塑造本文附錄的圖則上以綠色顯示未來公共道路部份(以下簡稱「綠色範圍」)；及

(II) 按署長自行酌情要求，提供及建造指定橋樑、隧道、立交橋、地下通道、暗渠、高架橋、天橋、行人路、道路或其他指定構築物(以下簡稱「構築物」)

使建築物、車輛及行人的交通可在綠色範圍上進行；

(ii) 於本協議之日起12個曆月內或署長可批准的其他延長時期內自費以署長滿意的方式在綠色範圍鋪設地面、路邊石及渠道，並按署長可能要求為此等設施提供溝渠、污水渠、排水渠、消防栓與連接總水管的水管、街燈、交通標誌、街道設施及道路標記；及

(iii) 自費保養綠色範圍連同構築物以及興建、設置及提供在該範圍之上或之內所有構築物、路面、溝渠、污水渠、排水渠、消防栓、服務、街燈、交通標誌、街道設施、道路標記及植物，使署長滿意，直至按批地文件特別條款第(4)條指定交還綠色範圍的管有權為止。

- (b) 倘若購買人未能在指定的期限內履行本特別條款第(a)項規定他的責任，政府可進行必要的工程，費用由購買人承擔。購買人須在要求時向政府支付署長決定相等於該工程費用的款項，署長的決定是最終的及約束購買人。
 - (c) 政府對購買人履行本特別條款第(a)項規定他的責任或政府履行本特別條款第(b)項規定他的責任造成或引致購買人或其他人士蒙受任何損失、損害、滋擾、干擾毋須承擔任何責任。購買人不能就上述損失、損害、滋擾或干擾向政府索償。
- (4) 僅為了進行特別條款第(3)條指定的必要工程，購買人於本協議之日獲授予綠色範圍的管有權並須在要求時交還予政府。在任何情況下，於署長致函予購買人當日，證明已履行批地文件的規定，使他滿意，即視作購買人已交還綠色範圍予政府。購買人須在他管有綠色範圍期間，允許所有政府和公共車輛及行人在合理時間內自由出入綠色範圍並確保不受到按特別條款第(3)條或其他規定進行的工程之干涉或阻礙。
- (5) 未經署長的預先書面同意，購買人不得使用綠色範圍作儲物用途或搭建任何臨時構築物或任何用途，除了進行批地文件特別條款第(3)條指定的工程
- (6) (a) 購買人須在管有綠色範圍期間，於任何合理時間內：
- (i) 准許政府、署長及他的官員、承建商、署長授權的任何其他人士有權出入、經過及再經過該地段及綠色範圍，旨在視察、檢查及監管批地文件特別條款第(3)(a)條指定的工程和進行、檢查及監管特別條款第(3)(b)條指定的工程及署長認為有必要在綠色範圍進行的任何其他工程；
 - (ii) 准許政府和政府授權的有關公用事業公司在他們要求時有權出入、經過及再經過該地段及綠色範圍，旨在綠色範圍或任何毗鄰土地之內、之上或之下進行任何工程，包括但不限於鋪設和其後保養一切管道、電線、槽、電纜槽及其他傳導媒介及輔助設備，以便提供電話、電力、煤氣(如有)及其他服務給該地段或任何毗鄰或毗連土地及物業。購買人須充分配合政府和政府正式授權的有關公用事業公司在綠色範圍內進行上述工程的一切事宜；及
 - (iii) 准許水務監督的官員和他們授權的其他人士在他們要求時有權出入、經過及再經過該地段及綠色範圍，旨在進行有關操作、保養、修理、更換、更改綠色範圍內的任何水務工程裝置。
- (b) 政府、署長及他的官員、承建商、代理人和按本特別條款第(a)項正式授權的任何人士及公用事業公司對於政府、署長及他的官員、承建商、代理人和按本特別條款第(a)項正式授權的任何人士或公用事業公司行使該權利造成或引致購買人或任何其他人士蒙受任何損失、損害、滋擾或干擾毋須承擔任何責任。

(b) 公契對綠色範圍的規定

公契第二附表B部分第(c)段的規定：

公眾人士、地政總署署長及他的官員、承建商及署長授權的任何人士有權利及特權按政府批地文件特別條款第(31)(b)(ii)條使用粉紅色加黑斜線範圍(按政府批地文件特別條款第(31)(a)條界定)直至綠色範圍(按政府批地文件特別條款第(3)(a)(i)(I)條規定)按政府批地文件特別條款第(4)條塑造及交還予政府。綠色範圍已按政府批地文件特別條款第(4)條規定於2013年4月15日交還予政府。

(c) 公眾人士有權按批地文件使用綠色範圍。

(d) 發展項目住宅物業的業主須出資管理、操作或保養綠色範圍。業主須按有關住宅物業分攤的管理開支支付管理、操作或保養綠色範圍的開支之部分。

2. 批地文件特別條款第(31)條提及的現有路徑(「現有路徑」)

(a) 批地文件對現有路徑的規定

批地文件特別條款第(31)條規定：

- (a) 購買人承認於本協議之日在本協議附錄的圖則上用粉紅色加黑斜線顯示的該地段部分上存在一條現有路徑。(以下簡稱「粉紅色加黑斜線範圍」)
- (b) 除非已按特別條款第(3)條規定塑造綠色範圍並按特別條款第(4)條交還予政府。
 - (i) 購買人須自費維護、保養及維修粉紅色加黑斜線範圍內的現有路徑，在一切方面使署長滿意。
 - (ii) 購買人須允許公眾人士、署長及他的官員、承建商及署長授權的任何人士為了一切合法目的自由及毋須作出任何性質的付款於任何時間內帶上或不帶上工具、設備、機械、機器或車輛經過及再經過粉紅色加黑斜線範圍。
- (c) 倘若購買人未能在指定的期限內履行本特別條款第(a)項規定他的責任，政府可進行必要的工程，費用由購買人承擔。購買人須在要求時向政府支付署長決定相等於該工程費用的款項，署長的決定是最終的及約束購買人。為了進行上述工程，政府、署長和他的官員、承建商、代理人、工人及獲正式授權的其他人士有權在任何合理時間內自由及不受阻礙地進入該地段或其中部分。
- (d) 政府、署長及他的官員、承建商、代理人、工人及正式授權的任何人士對於購買人履行本特別條款第(b)項規定他的責任或政府、署長及他的官員、承建商、代理人、工人及正式授權的任何人士履行本特別條款第(c)項或其他規定他們的責任造成或引致購買人或其他人士蒙受任何損失、損害、滋擾、干擾毋須承擔任何責任。購買人不能就上述損失、損害、滋擾或干擾向政府、署長及他的官員、承建商、代理人、工人及正式授權的任何人士索償。
- (e) 不准在粉紅色加黑斜線範圍之上、上面、之下、以上、以下或之內設置車位、避車處或裝卸區。

(b) 公契對現有路徑的規定

公契第二附表B部分第(c)段規定：

公眾人士、地政總署署長及他的官員、承建商及署長授權的任何人士有權利及特權按政府批地文件特別條款第(31)(b)(ii)條使用粉紅色加黑斜線範圍(按政府批地文件特別條款第(31)(a)條界定)直至綠色範圍(按政府批地文件特別條款第(3)(a)(i)(I)條規定)按政府批地文件特別條款第(4)條塑造及交還予政府。綠色範圍已按政府批地文件特別條款第(4)條規定於2013年4月15日交還予政府。

(c) 公眾人士有權按批地文件使用現有路徑。

(d) 發展項目住宅物業的業主須出資管理、操作或保養現有路徑。業主須按有關住宅物業分攤的管理開支支付管理、操作或保養現有路徑的開支之部分。

C. 批地文件規定須由發展項目中的住宅物業的擁有人出資管理、營運或維持以供公眾使用的休憩用地

不適用

D. 該發展項目所位於的土地中為施行建築(規劃)規例(第123章，附屬法例F)第22(1)條而撥供公眾用途的任何部份

不適用

備註：

於2013年4月15日已按批地文件特別條款第(4)條規定交還綠色範圍給政府。



- Pink Hatched Black Area
粉紅色加黑斜線範圍
- Pink Cross-hatched Black Area
粉紅色加黑網線範圍
- Green Area
綠色範圍

This plan is a reproduction of the plan as annexed to the Land Grant, which shows the location of the public facilities.
 此圖複製附於批地文件的圖則，顯示相關公共設施的位置。

1. The purchaser is recommended to instruct a separate firm of solicitors (other than that acting for the owner) to act for the purchaser in relation to the transaction.
2. If the purchaser instructs such separate firm of solicitors to act for the purchaser in relation to the transaction, that firm will be able to give independent advice to the purchaser.
3. If the purchaser instructs the firm of solicitors acting for the owner to act for the purchaser as well, and a conflict of interest arises between the owner and the purchaser:-
 - (i) that firm may not be able to protect the purchaser's interests; and
 - (ii) the purchaser may have to instruct a separate firm of solicitors; and
 - (iii) in the case of paragraph 3(ii), the total solicitors' fees payable by the purchaser may be higher than the fees that would have been payable if the purchaser had instructed a separate firm of solicitors in the first place.

1. 現建議買方聘用一間獨立的律師事務所（代表擁有人行事者除外），以在交易中代表買方行事。
2. 如買方聘用上述的獨立的律師事務所，以在交易中代表買方行事，該律師事務所將會能夠向買方提供獨立意見。
3. 如買方聘用代表擁有人行事的律師事務所同時代表買方行事，而擁有人與買方之間出現利益衝突：-
 - (i) 該律師事務所可能不能夠保障買方的利益；及
 - (ii) 買方可能要聘用一間獨立的律師事務所；及
 - (iii) 如屬 3(ii) 段的情況，買方須支付的律師費用總數，可能高於如買方自一開始即聘用一間獨立的律師事務所便須支付的費用。

Key Plan
索引圖

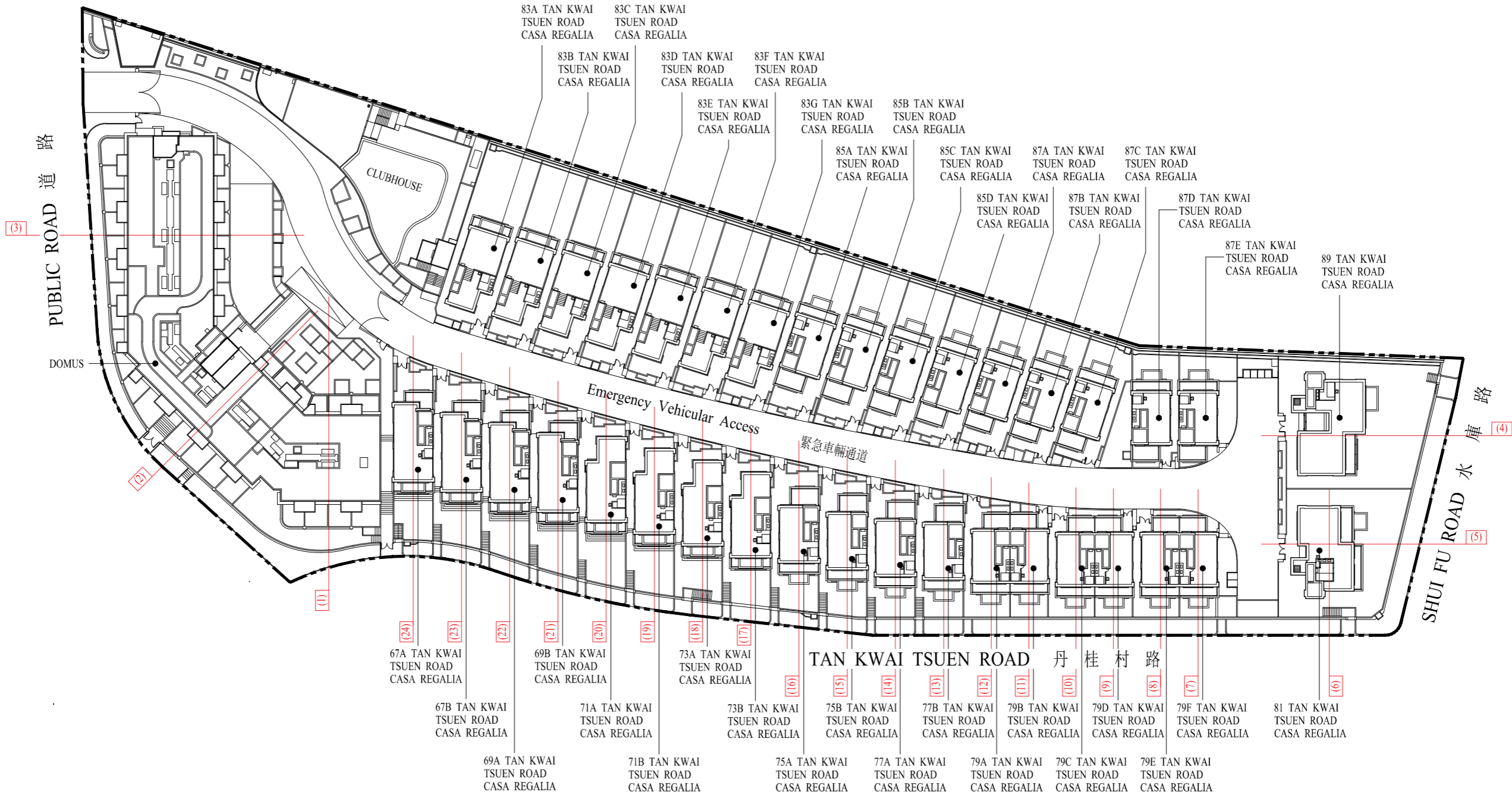

CROSS-SECTION PLAN OF BUILDING IN THE DEVELOPMENT 發展項目中的建築物的橫截面圖

DOMUS 尚築

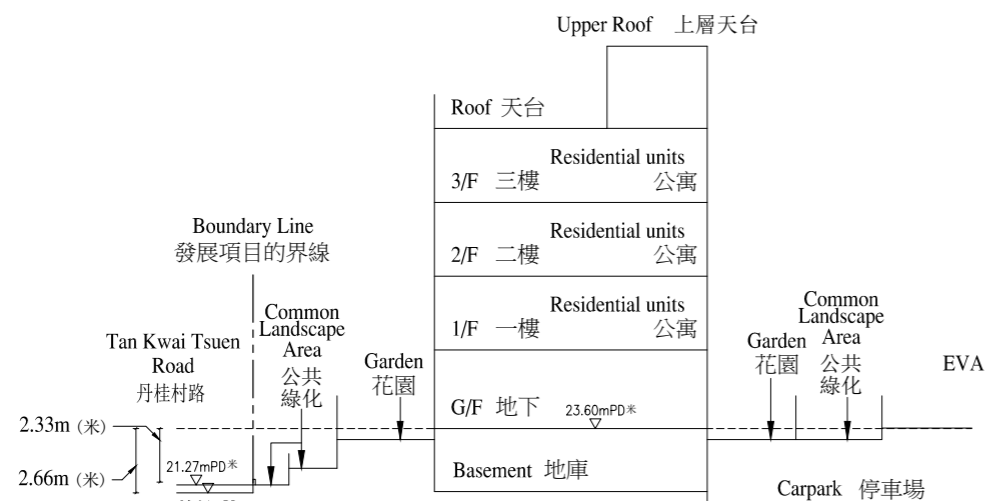

Cross-section Plan (1)
橫截面圖 (1)

----- Dotted line denotes the lowest residential floor.
虛線為最低的一層住宅樓層水平。

EVA: Emergency Vehicular Access 緊急車輛通道

The Part of Tan Kwai Road adjacent to the building is 20.94 to 21.27 metres above the Hong Kong Principal Datum.
毗連建築物的一段丹桂村路為香港主水平基準以上20.94至21.27米。

DOMUS 尚築

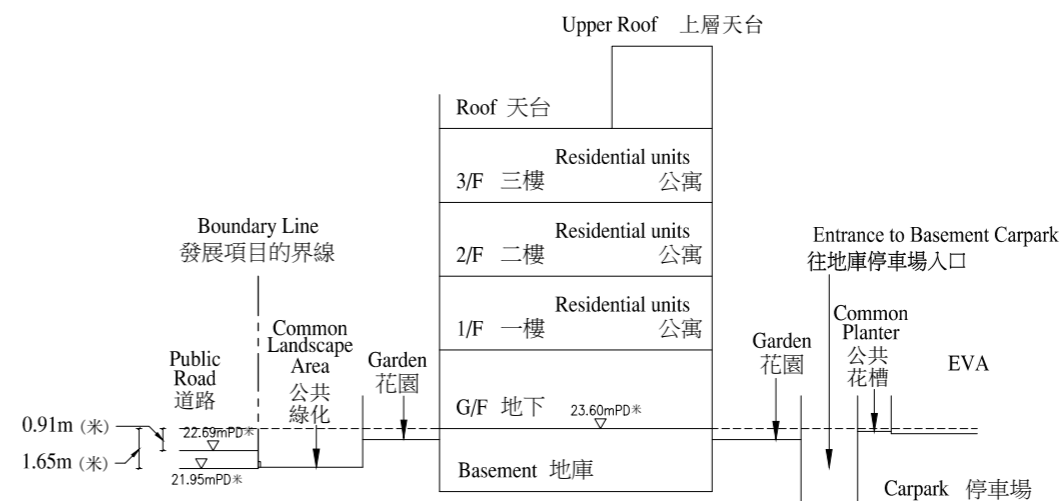

Cross-section Plan (3)
橫截面圖 (3)

----- Dotted line denotes the lowest residential floor.
虛線為最低的一層住宅樓層水平。

EVA: Emergency Vehicular Access 緊急車輛通道

The Part of Tan Kwai Road adjacent to the building is 21.95 to 22.69 metres above the Hong Kong Principal Datum.
毗連建築物的一段丹桂村路為香港主水平基準以上21.95至22.69米。

DOMUS 尚築

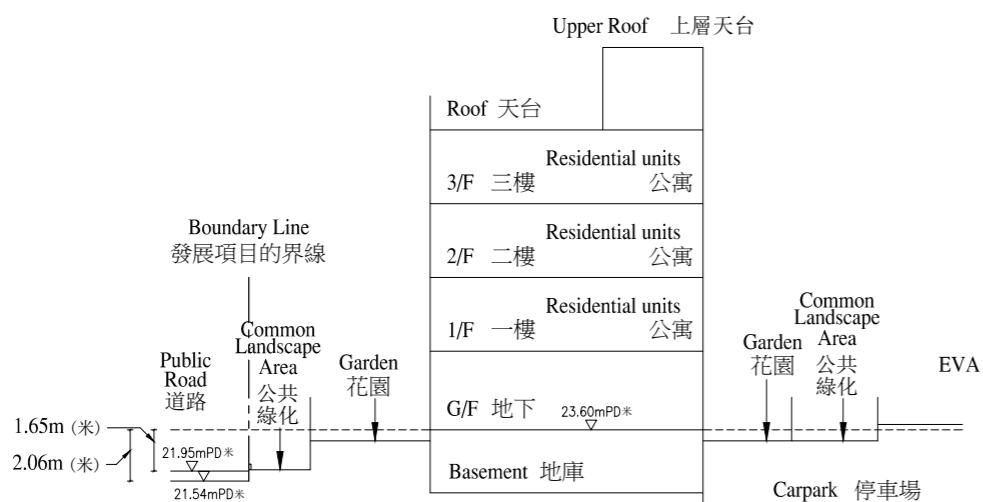

Cross-section Plan (2)
橫截面圖 (2)

----- Dotted line denotes the lowest residential floor.
虛線為最低的一層住宅樓層水平。

EVA: Emergency Vehicular Access 緊急車輛通道

The Part of Tan Kwai Road adjacent to the building is 21.54 to 21.95 metres above the Hong Kong Principal Datum.
毗連建築物的一段丹桂村路為香港主水平基準以上21.54至21.95米。

89 Tan Kwai Tsuen Road, Casa Regalia
富豪·悦庭丹桂村路89號

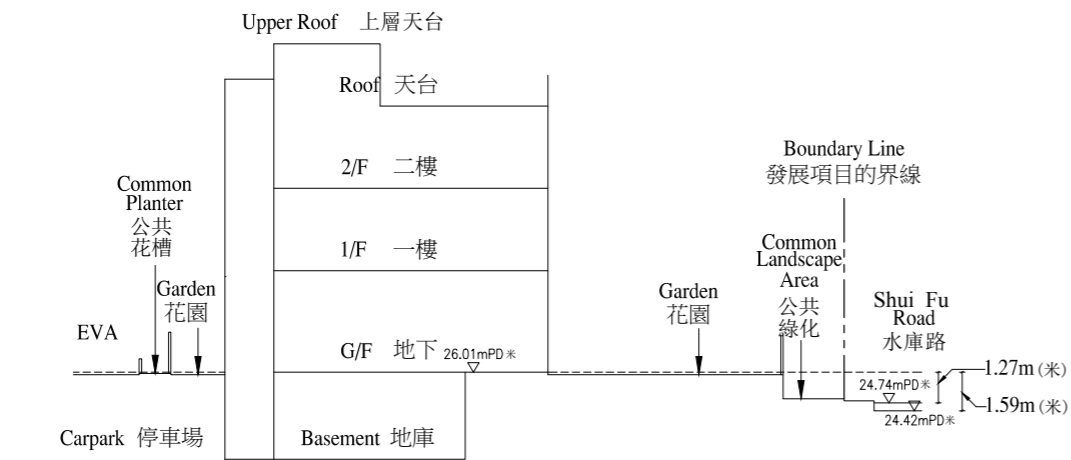

Cross-section Plan (4)
橫截面圖 (4)

----- Dotted line denotes the lowest residential floor.
虛線為最低的一層住宅樓層水平。

EVA: Emergency Vehicular Access 緊急車輛通道

The Part of Shui Fu Road adjacent to the building is 24.42 to 24.74 metres above the Hong Kong Principal Datum.
毗連建築物的一段水庫路為香港主水平基準以上24.42至24.74米。

81 Tan Kwai Tsuen Road, Casa Regalia
富豪·悦庭丹桂村路81號

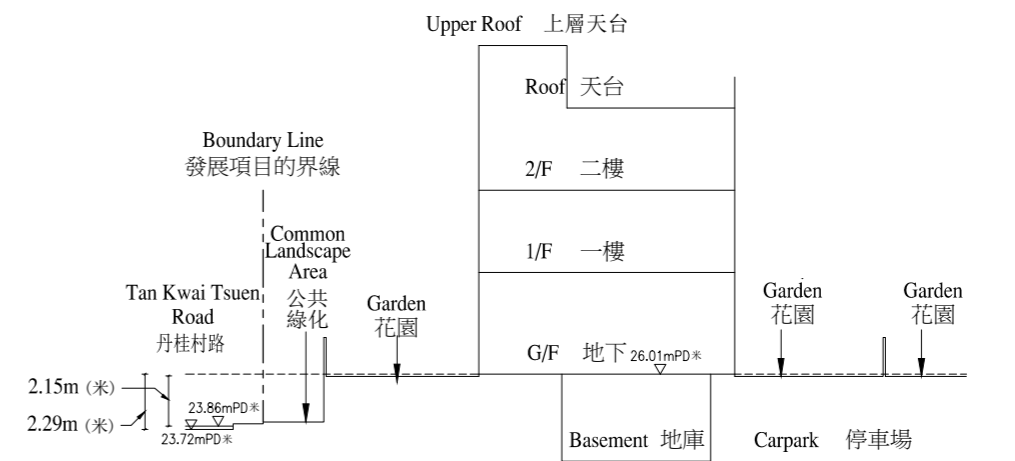

Cross-section Plan (6)
橫截面圖 (6)

----- Dotted line denotes the lowest residential floor.
虛線為最低的一層住宅樓層水平。

EVA: Emergency Vehicular Access 緊急車輛通道

The Part of Shui Fu Road adjacent to the building is 23.72 to 23.86 metres above the Hong Kong Principal Datum.
毗連建築物的一段水庫路為香港主水平基準以上23.72至23.86米。

81 Tan Kwai Tsuen Road, Casa Regalia
富豪·悦庭丹桂村路81號

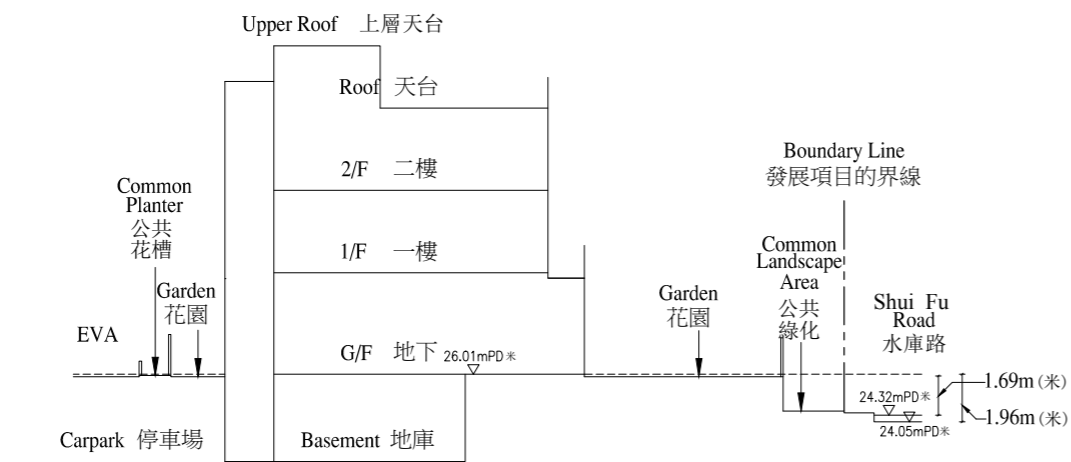

Cross-section Plan (5)
橫截面圖 (5)

----- Dotted line denotes the lowest residential floor.
虛線為最低的一層住宅樓層水平。

EVA: Emergency Vehicular Access 緊急車輛通道

The Part of Shui Fu Road adjacent to the building is 24.05 to 24.32 metres above the Hong Kong Principal Datum.
毗連建築物的一段水庫路為香港主水平基準以上24.05至24.32米。

79F Tan Kwai Tsuen Road, Casa Regalia
富豪·悦庭丹桂村路79F號

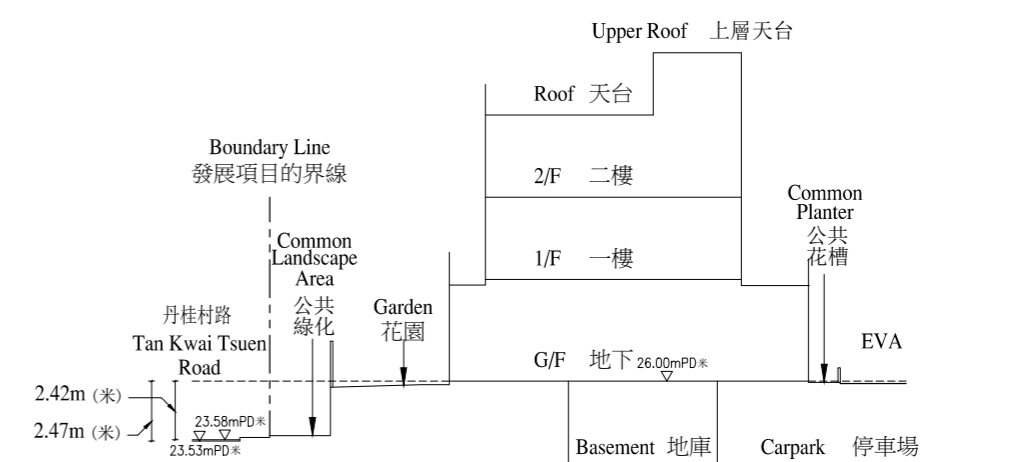

Cross-section Plan (7)
橫截面圖 (7)

----- Dotted line denotes the lowest residential floor.
虛線為最低的一層住宅樓層水平。

EVA: Emergency Vehicular Access 緊急車輛通道

The Part of Tan Kwai Road adjacent to the building is 23.53 to 23.58 metres above the Hong Kong Principal Datum.
毗連建築物的一段丹桂村路為香港主水平基準以上23.53至23.58米。

CROSS-SECTION PLAN OF BUILDING IN THE DEVELOPMENT 發展項目中的建築物的橫截面圖

79E Tan Kwai Tsuen Road, Casa Regalia
富豪·悦庭丹桂村路79E號

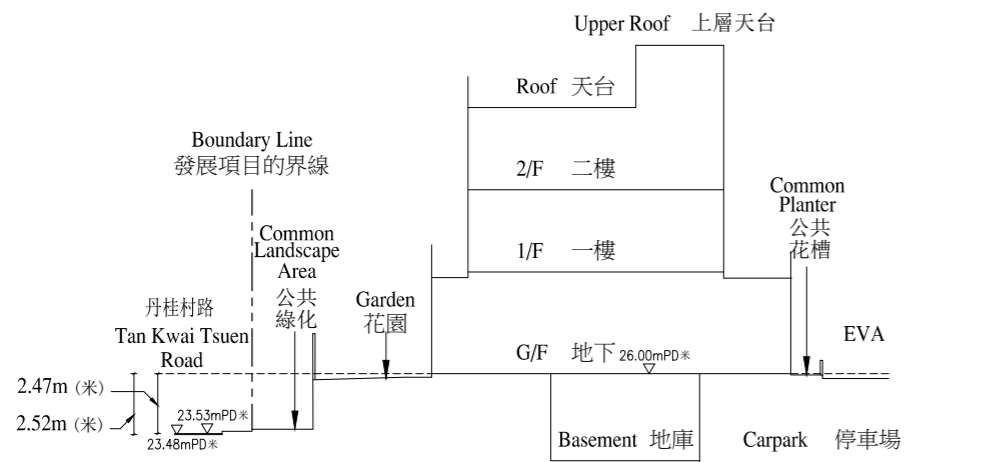

Cross-section Plan (8)
橫截面圖 (8)

----- Dotted line denotes the lowest residential floor.
虛線為最低的一層住宅樓層水平。

EVA: Emergency Vehicular Access 緊急車輛通道

The Part of Tan Kwai Road adjacent to the building is 23.48 to 23.53 metres above the Hong Kong Principal Datum.
毗連建築物的一段丹桂村路為香港主水平基準以上23.48至23.53米。

79C Tan Kwai Tsuen Road, Casa Regalia
富豪·悦庭丹桂村路79C號

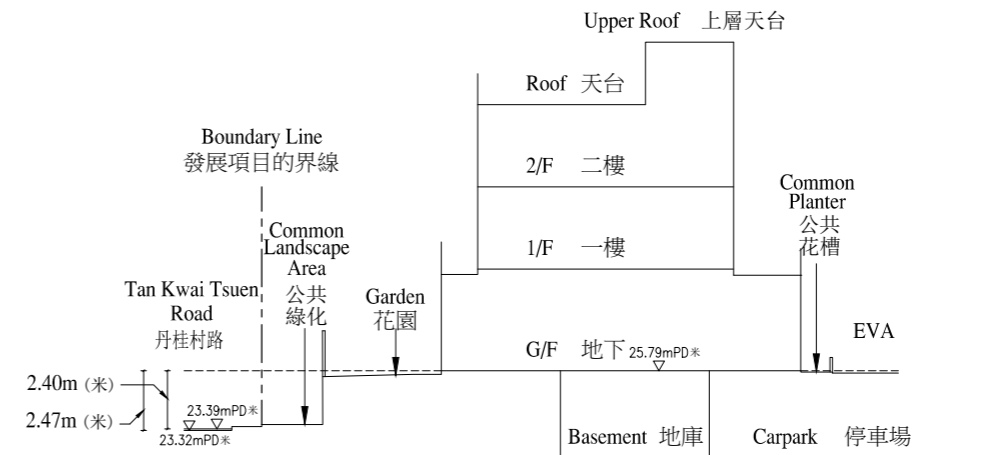

Cross-section Plan (10)
橫截面圖 (10)

----- Dotted line denotes the lowest residential floor.
虛線為最低的一層住宅樓層水平。

EVA: Emergency Vehicular Access 緊急車輛通道

The Part of Tan Kwai Road adjacent to the building is 23.32 to 23.39 metres above the Hong Kong Principal Datum.
毗連建築物的一段丹桂村路為香港主水平基準以上23.32至23.39米。

79D Tan Kwai Tsuen Road, Casa Regalia
富豪·悦庭丹桂村路79D號

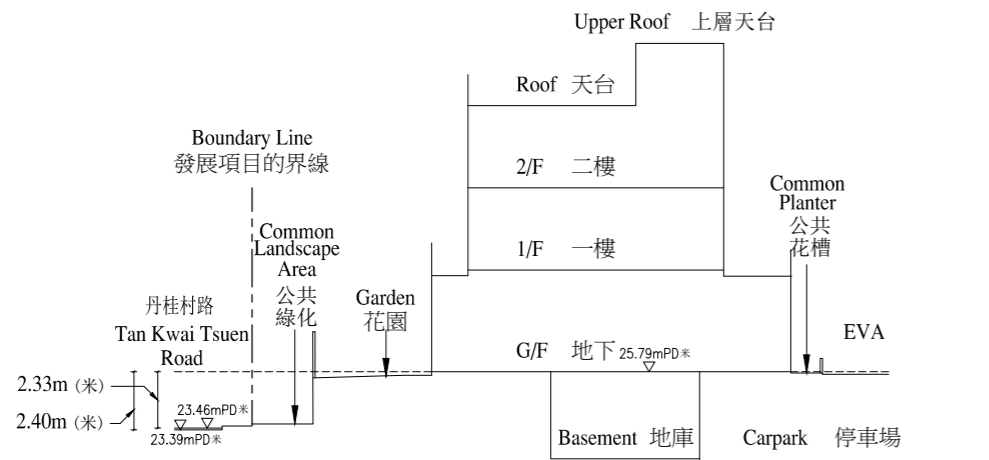

Cross-section Plan (9)
橫截面圖 (9)

----- Dotted line denotes the lowest residential floor.
虛線為最低的一層住宅樓層水平。

EVA: Emergency Vehicular Access 緊急車輛通道

The Part of Tan Kwai Road adjacent to the building is 23.39 to 23.46 metres above the Hong Kong Principal Datum.
毗連建築物的一段丹桂村路為香港主水平基準以上23.39至23.46米。

79B Tan Kwai Tsuen Road, Casa Regalia
富豪·悦庭丹桂村路79B號

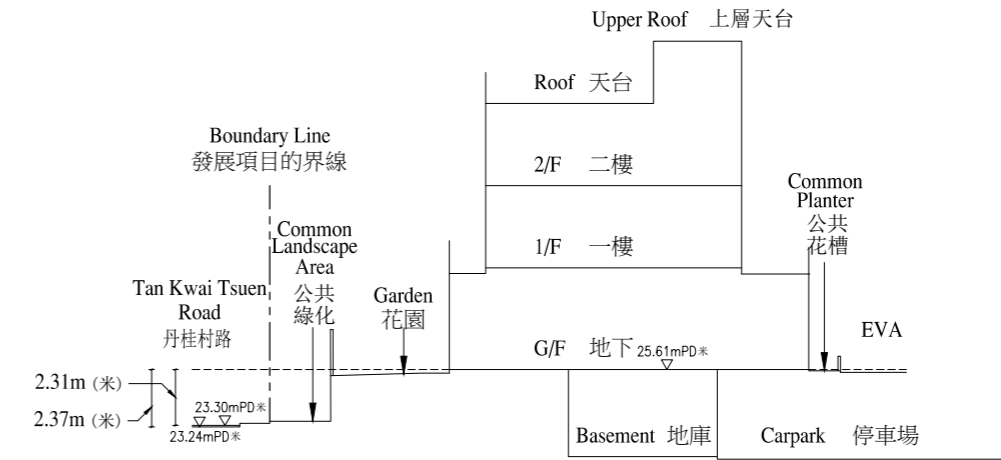

Cross-section Plan (11)
橫截面圖 (11)

----- Dotted line denotes the lowest residential floor.
虛線為最低的一層住宅樓層水平。

EVA: Emergency Vehicular Access 緊急車輛通道

The Part of Tan Kwai Road adjacent to the building is 23.24 to 23.30 metres above the Hong Kong Principal Datum.
毗連建築物的一段丹桂村路為香港主水平基準以上23.24至23.30米。

79A Tan Kwai Tsuen Road, Casa Regalia
富豪·悅庭丹桂村路79A號

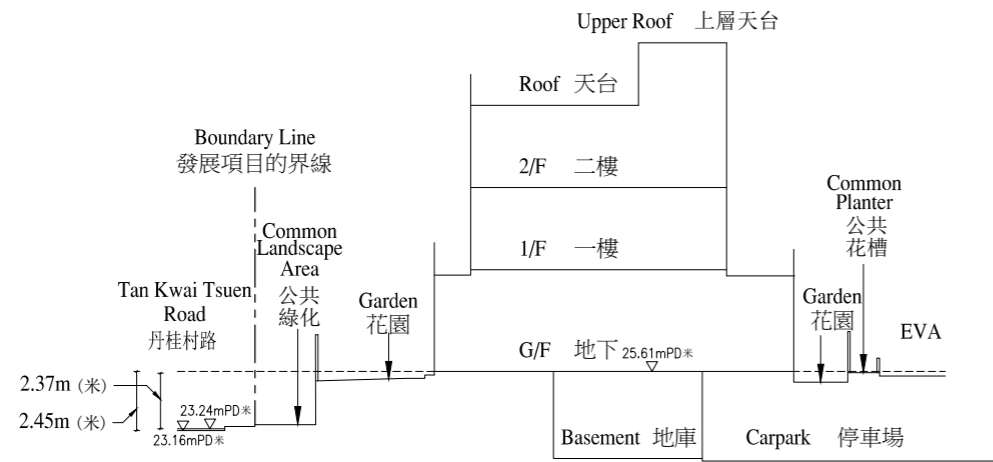

Cross-section Plan (12)
橫截面圖 (12)

----- Dotted line denotes the lowest residential floor.
虛線為最低的一層住宅樓層水平。

EVA: Emergency Vehicular Access 緊急車輛通道

The Part of Tan Kwai Road adjacent to the building is 23.16 to 23.24 metres above the Hong Kong Principal Datum.
毗連建築物的一段丹桂村路為香港主水平基準以上23.16至23.24米。

77A Tan Kwai Tsuen Road, Casa Regalia
富豪·悅庭丹桂村路77A號

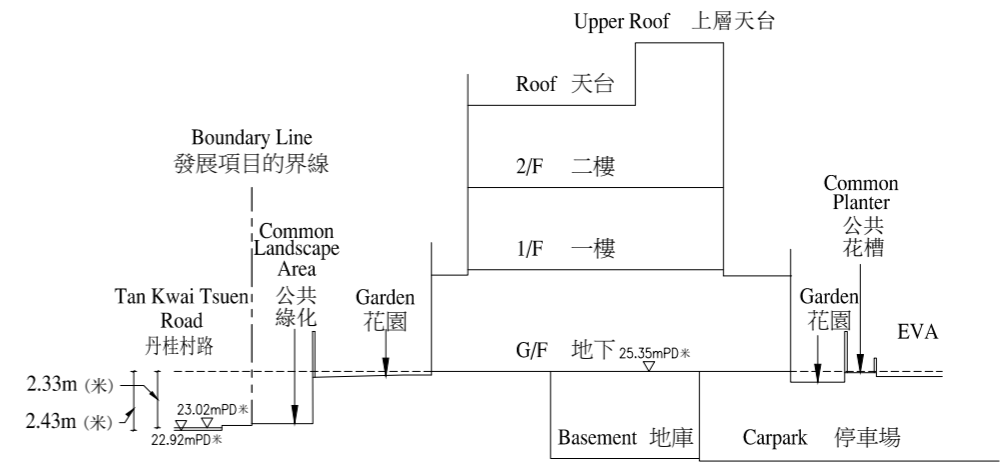

Cross-section Plan (14)
橫截面圖 (14)

----- Dotted line denotes the lowest residential floor.
虛線為最低的一層住宅樓層水平。

EVA: Emergency Vehicular Access 緊急車輛通道

The Part of Tan Kwai Road adjacent to the building is 22.92 to 23.02 metres above the Hong Kong Principal Datum.
毗連建築物的一段丹桂村路為香港主水平基準以上22.92至23.02米。

77B Tan Kwai Tsuen Road, Casa Regalia
富豪·悅庭丹桂村路77B號

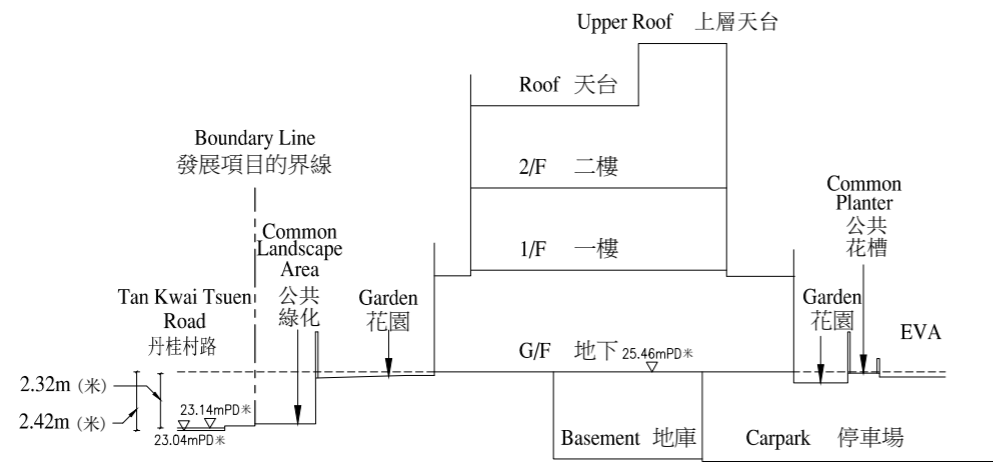

Cross-section Plan (13)
橫截面圖 (13)

----- Dotted line denotes the lowest residential floor.
虛線為最低的一層住宅樓層水平。

EVA: Emergency Vehicular Access 緊急車輛通道

The Part of Tan Kwai Road adjacent to the building is 23.04 to 23.14 metres above the Hong Kong Principal Datum.
毗連建築物的一段丹桂村路為香港主水平基準以上23.04至23.14米。

75B Tan Kwai Tsuen Road, Casa Regalia
富豪·悅庭丹桂村路75B號

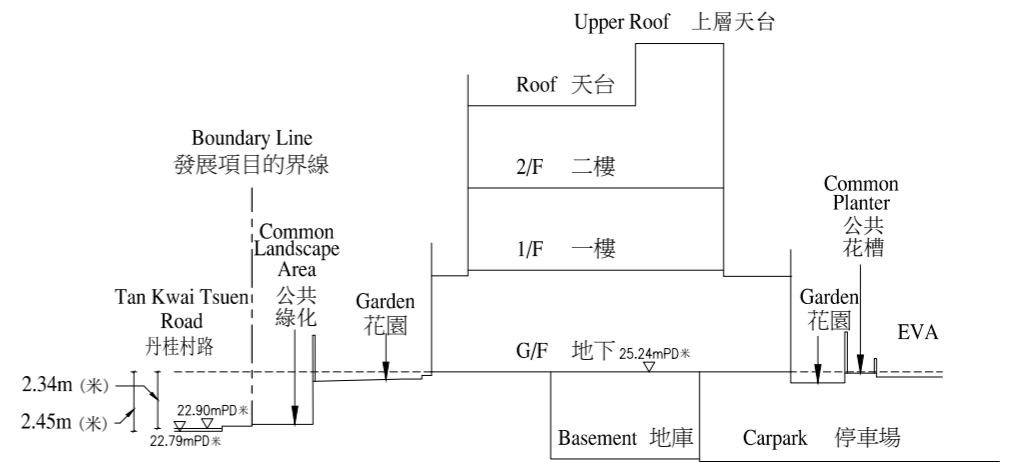

Cross-section Plan (15)
橫截面圖 (15)

----- Dotted line denotes the lowest residential floor.
虛線為最低的一層住宅樓層水平。

EVA: Emergency Vehicular Access 緊急車輛通道

The Part of Tan Kwai Road adjacent to the building is 22.79 to 22.90 metres above the Hong Kong Principal Datum.
毗連建築物的一段丹桂村路為香港主水平基準以上22.79至22.90米。

CROSS-SECTION PLAN OF BUILDING IN THE DEVELOPMENT 發展項目中的建築物的橫截面圖

75A Tan Kwai Tsuen Road, Casa Regalia
富豪·悦庭丹桂村路75A號

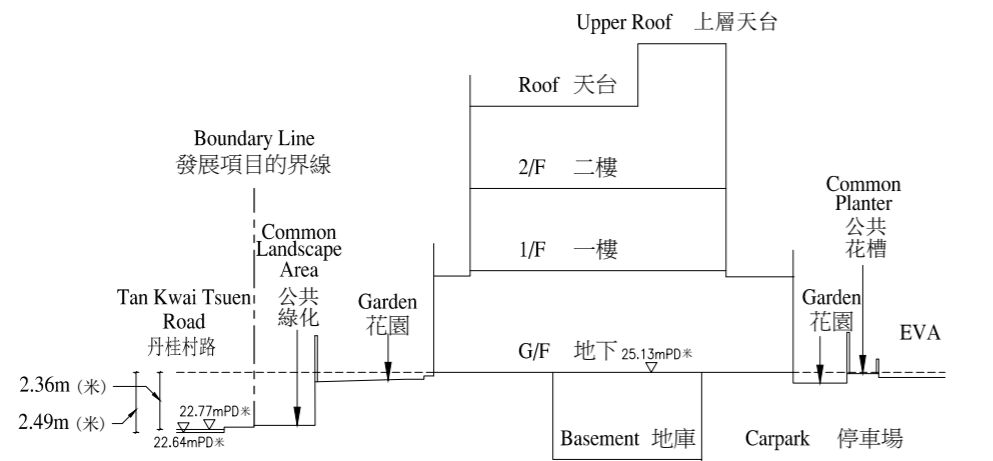

Cross-section Plan (16)
橫截面圖 (16)

----- Dotted line denotes the lowest residential floor.
虛線為最低的一層住宅樓層水平。

EVA: Emergency Vehicular Access 緊急車輛通道

The Part of Tan Kwai Road adjacent to the building is 22.64 to 22.77 metres above the Hong Kong Principal Datum.
毗連建築物的一段丹桂村路為香港主水平基準以上22.64至22.77米。

73A Tan Kwai Tsuen Road, Casa Regalia
富豪·悦庭丹桂村路73A號

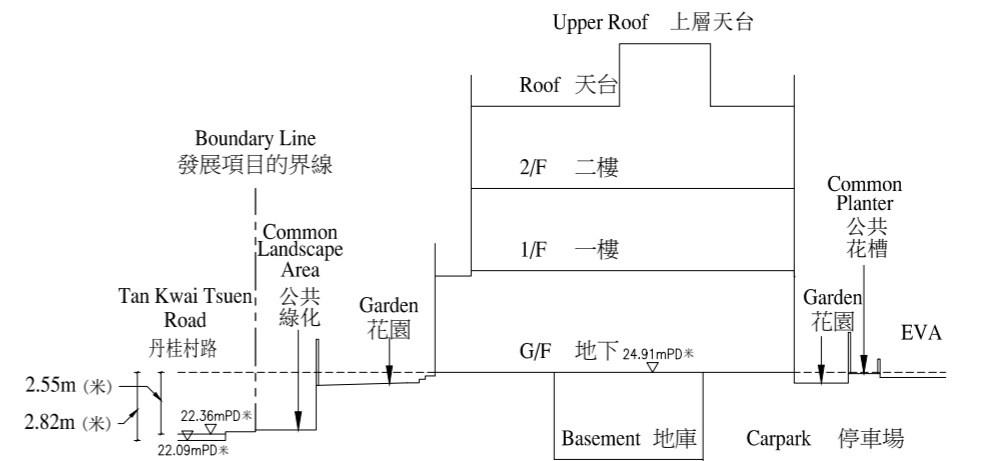

Cross-section Plan (18)
橫截面圖 (18)

----- Dotted line denotes the lowest residential floor.
虛線為最低的一層住宅樓層水平。

EVA: Emergency Vehicular Access 緊急車輛通道

The Part of Tan Kwai Road adjacent to the building is 22.09 to 22.36 metres above the Hong Kong Principal Datum.
毗連建築物的一段丹桂村路為香港主水平基準以上22.09至22.36米。

73B Tan Kwai Tsuen Road, Casa Regalia
富豪·悦庭丹桂村路73B號

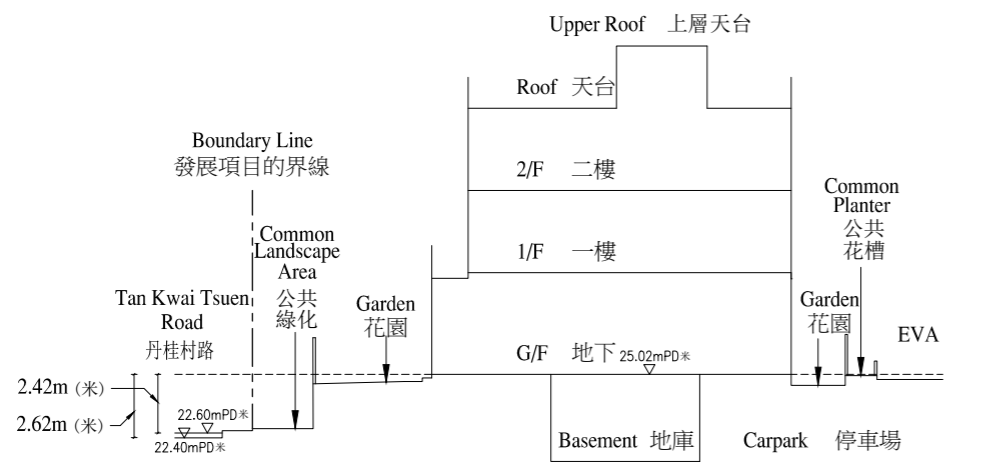

Cross-section Plan (17)
橫截面圖 (17)

----- Dotted line denotes the lowest residential floor.
虛線為最低的一層住宅樓層水平。

EVA: Emergency Vehicular Access 緊急車輛通道

The Part of Tan Kwai Road adjacent to the building is 22.40 to 22.60 metres above the Hong Kong Principal Datum.
毗連建築物的一段丹桂村路為香港主水平基準以上22.40至22.60米。

71B Tan Kwai Tsuen Road, Casa Regalia
富豪·悦庭丹桂村路71B號

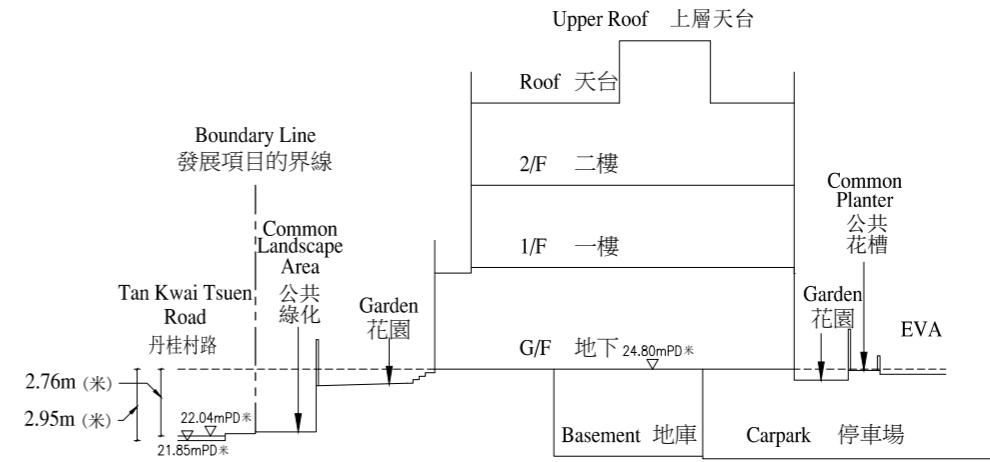

Cross-section Plan (19)
橫截面圖 (19)

----- Dotted line denotes the lowest residential floor.
虛線為最低的一層住宅樓層水平。

EVA: Emergency Vehicular Access 緊急車輛通道

The Part of Tan Kwai Road adjacent to the building is 21.85 to 22.04 metres above the Hong Kong Principal Datum.
毗連建築物的一段丹桂村路為香港主水平基準以上21.85至22.04米。

71A Tan Kwai Tsuen Road, Casa Regalia
富豪·悅庭丹桂村路71A號

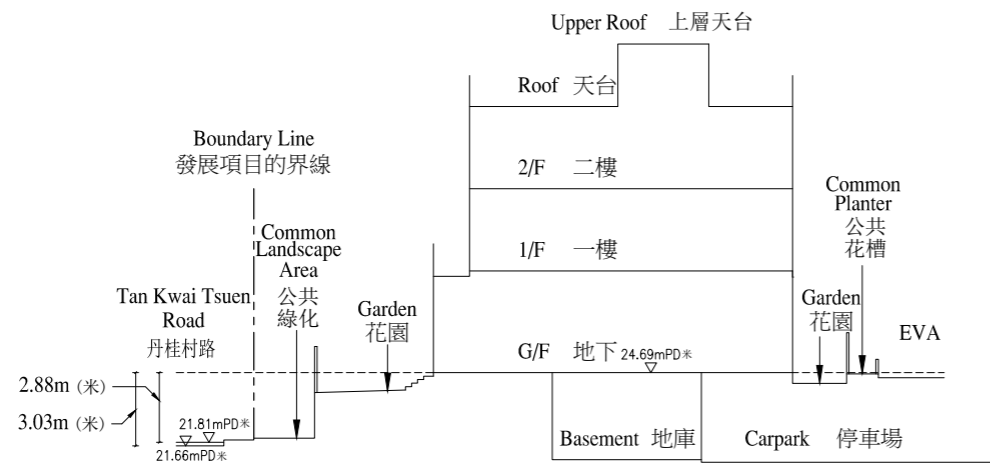

Cross-section Plan (20)
橫截面圖 (20)

----- Dotted line denotes the lowest residential floor.
虛線為最低的一層住宅樓層水平。

EVA: Emergency Vehicular Access 緊急車輛通道

The Part of Tan Kwai Road adjacent to the building is 21.66 to 21.81 metres above the Hong Kong Principal Datum.
毗連建築物的一段丹桂村路為香港主水平基準以上21.66至21.81米。

69A Tan Kwai Tsuen Road, Casa Regalia
富豪·悅庭丹桂村路69A號

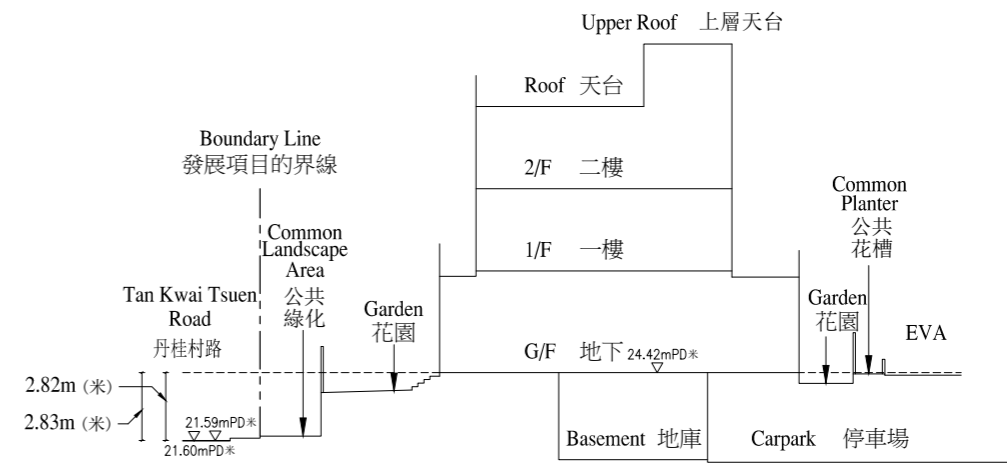

Cross-section Plan (22)
橫截面圖 (22)

----- Dotted line denotes the lowest residential floor.
虛線為最低的一層住宅樓層水平。

EVA: Emergency Vehicular Access 緊急車輛通道

The Part of Tan Kwai Road adjacent to the building is 21.59 to 21.60 metres above the Hong Kong Principal Datum.
毗連建築物的一段丹桂村路為香港主水平基準以上21.59至21.60米。

69B Tan Kwai Tsuen Road, Casa Regalia
富豪·悅庭丹桂村路69B號

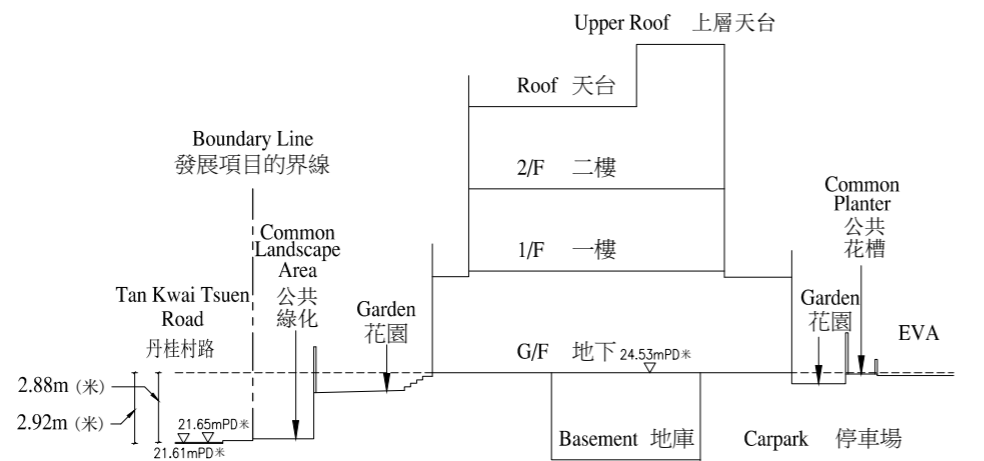

Cross-section Plan (21)
橫截面圖 (21)

----- Dotted line denotes the lowest residential floor.
虛線為最低的一層住宅樓層水平。

EVA: Emergency Vehicular Access 緊急車輛通道

The Part of Tan Kwai Road adjacent to the building is 21.61 to 21.65 metres above the Hong Kong Principal Datum.
毗連建築物的一段丹桂村路為香港主水平基準以上21.61至21.65米。

67B Tan Kwai Tsuen Road, Casa Regalia
富豪·悅庭丹桂村路67B號

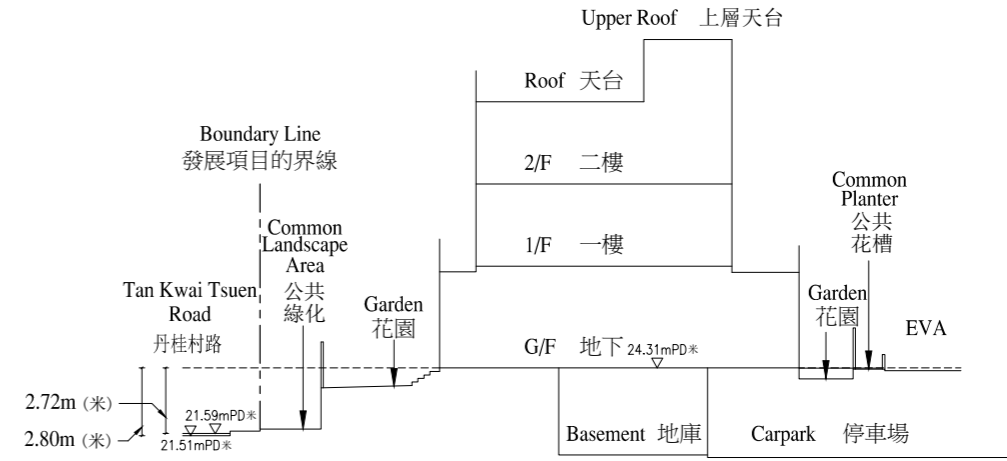

Cross-section Plan (23)
橫截面圖 (23)

----- Dotted line denotes the lowest residential floor.
虛線為最低的一層住宅樓層水平。

EVA: Emergency Vehicular Access 緊急車輛通道

The Part of Tan Kwai Road adjacent to the building is 21.51 to 21.59 metres above the Hong Kong Principal Datum.
毗連建築物的一段丹桂村路為香港主水平基準以上21.51至21.59米。

CROSS-SECTION PLAN OF BUILDING IN THE DEVELOPMENT 發展項目中的建築物的橫截面圖

67A Tan Kwai Tsuen Road, Casa Regalia
富豪·悅庭丹桂村路67A號

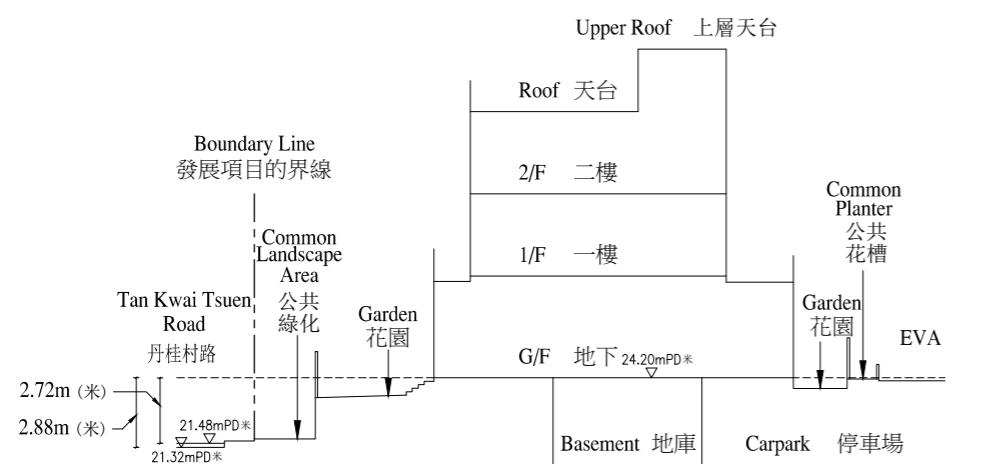

Cross-section Plan (24)
橫截面圖 (24)

----- Dotted line denotes the lowest residential floor.

虛線為最低的一層住宅樓層水平。

EVA: Emergency Vehicular Access 緊急車輛通道

The Part of Tan Kwai Road adjacent to the building is 21.32 to 21.48 metres above the Hong Kong Principal Datum.
毗連建築物的一段丹桂村路為香港主水平基準以上21.32至21.48米。

The Authorized Person for the Development has certified that the elevations shown on this plan:
1. Are prepared on the basis of the approved building plans for the Development as at 20 July 2015;
2. Are in general accordance with the outward appearance of the Development.

發展項目的認可人士已證明本圖所顯示的立面圖

1. 以2015年7月20日此發展項目經批准的建築圖則為基礎擬備；
2. 大致上與發展項目外觀一致。

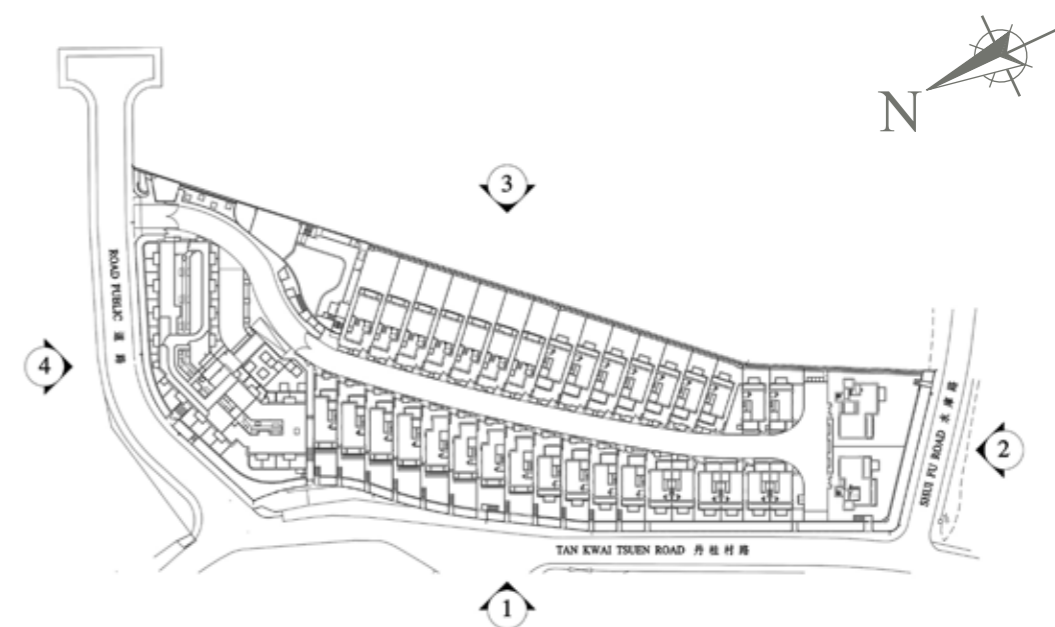

ELEVATION 1
立面圖 1



ELEVATION 2
立面圖 2

ELEVATION PLAN 立面圖

The Authorized Person for the Development has certified that the elevations shown on this plan:
 1. Are prepared on the basis of the approved building plans for the Development as at 20 July 2015;
 2. Are in general accordance with the outward appearance of the Development.

發展項目的認可人士已證明本圖所顯示的立面圖
 1. 以2015年7月20日此發展項目經批准的建築圖則為基礎擬備；
 2. 大致上與發展項目外觀一致。

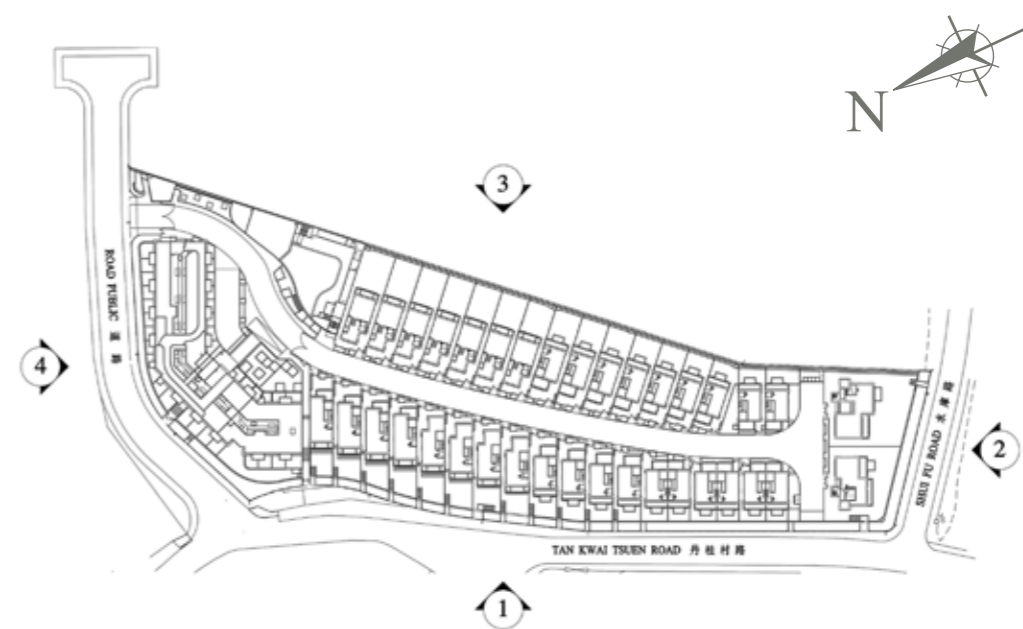

ELEVATION 3
立面圖 3



ELEVATION 4
立面圖 4

Common Facilities 公用設施		Area 範圍		Total Area 總面積	
		sq.m. 平方米	sq.ft 平方呎	sq.m. 平方米	sq.ft 平方呎
Residents' Clubhouse (including any recreational facilities for residents' use) 住客會所 (包括供住客使用的任何康樂設施)	Covered 有上蓋遮蓋	396.615	4270	843.375	9079
	Uncovered 無上蓋遮蓋	446.760	4809		
Communal garden or play area for residents' use on the roof, or on any floor between the roof and the lowest residential floor, of a building in the Development (whether known as a communal sky garden or otherwise) 位於發展項目中的建築物的天台或在天台和最低一層住宅樓層之間的任何一層的，供住客使用的公用花園或遊樂地方 (不論是稱為公用空中花園或有其他名稱)	Covered 有上蓋遮蓋	Not applicable 不適用		598.536	6443
	Uncovered 無上蓋遮蓋	598.536	6443		
Communal garden or play area for residents' use below the lowest residential floor of a building in the Development (whether known as a covered and landscaped play area or otherwise) 位於發展項目中的建築物的最低一層住宅樓層以下的，供住客使用的公用花園或遊樂地方 (不論是稱為有蓋及園景的遊樂場或有其他名稱)	Covered 有上蓋遮蓋	Not applicable 不適用		Not applicable 不適用	
	Uncovered 無上蓋遮蓋	Not applicable 不適用			

Note: Areas in square feet are converted at a rate of 1 square metre to 10.764 square feet and rounded off to the nearest integer.
備註：以平方呎顯示之面積均依據 1 平方米 = 10.764 平方呎換算，並四捨五入至整數。

INSPECTION OF PLANS AND DEED OF MUTUAL COVENANT 閱覽圖則及公契

1. Copies of the outline zoning plans relating to the Development is available at: <http://www.ozp.tpb.gov.hk>.
2. A copy of the deed of mutual covenant in respect of the residential property is available for inspection free of charge at the place at which the residential property is offered to be sold.

1. 備有關於本發展項目的分區計劃大綱圖的文本供閱覽的互聯網網站的網址為<http://www.ozp.tpb.gov.hk>。
2. 指明住宅物業的公契存放在住宅物業的售樓處，以供免費閱覽。

DOMUS

The Vendor undertakes that if lifts or appliances of the specified brand name or model number are not installed in the Development, lifts or appliances of comparable quality will be installed.

1. Exterior Finishes	
Item	Description
(a) External Wall	Finished with ceramic tiles, curtain walls, aluminum claddings, metal louver and grille.
(b) Window	PVF2 aluminum window frames fitted with grey tinted glass for living/dining room and Flat 30 on 3/F bedroom; PVF2 aluminum window frames fitted obscured grey tinted glass for bathroom. PVF2 metal window frames fitted with clear glass for staircases.
(c) Bay Window	Nil
(d) Planter	Externally finished with ceramic tiles.
(e) Verandah or balcony	Balconies for 1/F - 3/F Flats: Wall is finished with ceramic tiles and floor is finished with homogenous tiles. Ceiling is fitted with aluminum suspended ceiling. Fitted with metal railing. Balconies are covered. There is no balcony for G/F Flat. There is no verandah.
(f) Drying facilities for clothing	Nil

2. Interior Finishes	
Item	Description
(a) Lobby	Internal walls are finished with natural stone tiles, glass panels and wall paper. Floors are finished with ceramic tiles. Gypsum board false ceilings with emulsion paint are provided.
(b) Internal wall and ceiling	Internal Walls: Exposed surfaces of internal walls of living/dining room and Flat 30 on 3/F bedroom are painted with emulsion paint. Ceilings: Exposed surfaces of ceilings of living/dining room and Flat 30 on 3/F bedroom are finished with emulsion paint. Some areas are equipped with gypsum board false ceiling with emulsion paint.
(c) Internal floor	Living/dining room and Flat 30 on 3/F bedroom are finished with ceramic tiles. Timber skirting is provided.
(d) Bathroom	Exposed surfaces of walls are finished with ceramic tiles and obscured glass up to false ceiling. Exposed part of floor is finished with ceramic tiles. Gypsum board false ceilings are painted with emulsion paint.
(e) Kitchen	Exposed surfaces of walls are painted with emulsion paint and finished with mirror. Exposed surfaces of floors are finished with porcelain tiles. Gypsum board false ceilings are painted with emulsion paint. Cooking bench top is fitted with artificial solid surface material. Wall finishes run up to the false ceiling.

3. Interior Fittings	
Item	Description
(a) Doors	Entrance Door: Timber veneer finish solid core timber door fitted with lockset, door closer, eye viewer and door stopper. Flat 30 on 3/F Bedroom Door: Timber veneer finish hollow core timber door fitted with lockset and door stopper. Bathroom: Obscured sliding glass door. Garden (for Flats on G/F only) and Balcony (for Flats from 1/F to 3/F only): Sliding glass door with PVF2 aluminum frame fitted with lockset.
(b) Bathroom	Fitted with wooden mirror cabinet and artificial solid surface countertop. Fittings and equipment include vitreous china water closet, vitreous china wash basin, chrome plated wash basin mixer, chrome plated shower mixer for shower, chrome plated shower set, chrome plated towel ring and stainless steel paper holder. Ventilation fan is provided. Copper pipes are used for cold water supply system and copper water pipes with thermal insulation for hot water supply. For brand name and provisions of appliances, please refer to "Appliances Schedule".
(c) Kitchen	Kitchen Cabinet is completed with chipboard carcass, high gloss laminated surface door panel and melamine faced door panel, and equipped with artificial solid surface work top, stainless steel sink and chrome plated sink mixer. Copper pipes are used for cold water supply system and copper water pipes with thermal insulation for hot water supply. For brand name and provisions of appliances, please refer to "Appliances Schedule".
(d) Bedroom	Nil
(e) Telephone	Telephone connection point is provided for living/dining room and Flat 30 on 3/F bedroom. For the number and the location of connection points, please refer to the "Schedule of Mechanical & Electrical Provisions".
(f) Aerials	TV/FM outlet for local TV/FM radio programmes is provided in living/dining room and Flat 30 on 3/F bedroom. For location and number of connection points, please refer to the "Schedule of Mechanical & Electrical Provisions".
(g) Electrical Installations	Three-phase electricity supply with miniature circuit breaker distribution boards completed with residual-current device is provided. Conduit wiring concealed in walls or enclosed in false ceilings or bulkheads or cabinets for lightings and power points are provided. For the number and the location of power points and air-conditioner points, please refer to the "Schedule of Mechanical & Electrical Provisions".
(h) Gas Supply	Nil
(i) Washing Machine Connection Point	Drain point and water point are located in the kitchen.

DOMUS

3. Interior Fittings	
Item	Description
(j) Water Supply	Copper water pipes are provided for cold water supply and copper water pipes with thermal insulation are provided for hot water supply. Hot water supply system is provided to kitchen and bathroom. Both hot and cold water pipes are partly concealed and partly exposed. ¹

4. Miscellaneous	
Item	Description
(a) Lifts	DOMUS is provided with 2 nos. “Fujitect” lift (model no. ML-GSh) serving the G/F, 1/F, 2/F, 3/F and R/F.
(b) Letter Box	Metal letter box is provided for each residential property.
(c) Refuse Collection	A refuse storage & material recovery room is provided in the common area of each residential floor of DOMUS. 1 no. of common refuse storage and material recovery chamber with vehicular access is provided at G/F for collection of refuse.
(d) Water Meter, Electricity Meter and Gas Meter	Separate water meter for each residential property is provided at water meter cabinet at residential floors of DOMUS. Separate electricity meter for each residential property is provided at electric room at residential floors of DOMUS. There is no gas meter.

5. Security Facilities	
Item	Description
Security System and Equipment	CCTV cameras are installed at G/F entrance lobbies, lifts, B/F car park, recreational facilities, emergency vehicular access at G/F, boundary fence walls are connected to the caretaker’s office. Visitor panel for access control is provided at G/F entrances of the DOMUS connecting to door phones in each residential property in DOMUS.

6. Appliances	
Item	Description
Appliances	For brand names and model numbers of appliances provided, please refer to the “Appliances Schedule”.

Notes:

- Other than those parts of the water pipes concealed with concrete, the rest of them are exposed. The exposed water pipes may be covered or hidden by false ceilings, bulkheads, cabinets, claddings, non-concrete partition walls, designated pipe ducts or other materials.

尚築

賣方承諾如項目中沒有安裝指明的品牌名稱或產品型號的升降機或設備，便會安裝品質相若的升降機或設備。

1. 外部裝修物料	
細項	描述
(a) 外牆	鋪砌瓷磚、玻璃幕牆、鋁板、金屬百葉及格柵。
(b) 窗	客飯廳及 3 樓 30 單位睡房採用氟炭噴塗鋁窗框連灰面玻璃。浴室選用氟炭噴塗鋁窗框連半透光灰面玻璃。樓梯採用氟炭噴塗鐵窗框連清片玻璃。
(c) 窗台	沒有。
(d) 花槽	花槽外鋪砌瓷磚。
(e) 陽台或露台	1/F - 3/F 單位露台： 牆身鋪砌瓷磚，地台鋪砌均質瓷磚，裝有鋁質假天花及鐵欄杆。 為有蓋露台。 地下單位沒有露台。 沒有陽台。
(f) 乾衣設施	沒有。

2. 室內裝修物料	
細項	描述
(a) 大堂	牆身鋪砌天然石材、玻璃及牆紙。地板鋪砌瓷磚。設有石膏板假天花髹上乳膠漆。
(b) 內牆及天花板	內牆： 客飯廳及 3 樓 30 單位睡房內外露部份牆髹乳膠漆髹上乳膠漆。 天花板： 客飯廳及 3 樓 30 單位睡房的天花板外露部份髹上乳膠漆，部分以石膏板鋪砌假天花髹上乳膠漆。
(c) 內部地板	客飯廳及 3 樓 30 單位睡房內部地板鋪砌瓷磚。 單位配備木腳線。
(d) 浴室	外露牆身鋪砌瓷磚及半透光玻璃至假天花高度。外露地台鋪砌瓷磚。裝設石膏板假天花髹上乳膠漆。
(e) 廚房	外露牆身鋪砌玻璃鏡面及髹上乳膠漆。外露地台鋪砌瓷磚。裝設石膏板假天花髹上乳膠漆。灶台面為實心人造面板枱面。牆身飾面鋪砌至假天花高度。

3. 室內裝置	
細項	描述
(a) 門	單位大門： 木皮面實心木門。裝設門鎖、氣鼓、防盜眼及門阻。 3 樓 30 單位睡房： 木皮面空心木門。裝設門鎖及門阻。 浴室： 半透光玻璃趟門。 花園（只適用於地下單位）及露台（只適用於 1/F - 3/F 單位）： 氟炭噴塗鋁框玻璃趟門，裝設門鎖。
(b) 浴室	選用木面鏡櫃，實心人造面板檯面。裝置及設備包括陶瓷坐廁、陶瓷洗手盆、鍍鉻洗手盆水龍頭、淋浴設有鍍鉻花灑水龍頭、鍍鉻花灑套裝、鍍鉻飾面毛巾架及不銹鋼廁紙架。設有抽氣扇。冷水喉採用銅喉管，熱水喉採用隔熱絕緣銅喉。 隨樓附送之設備及品牌，請參閱“設備說明表”。
(c) 廚房	廚櫃由高級刨花板櫃體、高光貼面板櫃門和木紋耐高溫飾面貼面櫃門組成；並配有實心人造面板工作檯面、不銹鋼水槽和鍍鉻單控水龍頭。冷水喉採用銅喉管，熱水喉採用隔熱絕緣銅喉。 隨樓附送之設備及品牌，請參閱“設備說明表”。
(d) 睡房	沒有。
(e) 電話	客飯廳及 3 樓 30 單位睡房均裝設有電話插座。 有關接駁點的位置及數量，請參考“機電裝置數量說明表”。
(f) 天線	客飯廳及 3 樓 30 單位睡房均裝設有可接收本地電視節目及電台節目的電視 / 收音機天線插座。 有關接駁點的位置及數量，請參考“機電裝置數量說明表”。
(g) 電力裝置	提供三相電力配電箱並裝置有漏電斷路器。照明及電插座之導管暗藏於牆身或置於假天花、假陣或櫃內。 有關電插座及空調機接駁點的位置及數量，請參考“機電裝置數量說明表”。
(h) 氣體供應	沒有。
(i) 洗衣機接駁點	洗衣機來水及去水接駁點設在廚房。
(j) 供水	冷水喉採用之銅喉及熱水喉採用有隔熱絕緣保護之銅喉。 廚房及浴室有熱水供應。 冷熱水管是部分隱藏及部分外露。 ¹

尚築

4. 雜項	
細項	描述
(a) 升降機	尚築設有 2 部“富士達”升降機（型號：ML-GSh）直達至地下、一樓、二樓、三樓及天台。
(b) 信箱	每戶住宅單位設置金屬信箱。
(c) 垃圾收集	垃圾儲存及物料回收房位於尚築每層住宅樓層之公用地方。一個設有車輛通道公用垃圾儲存及物料回收房位於地下提供垃圾收集處理。
(d) 水錶、電錶及氣體錶	每戶住宅單位之獨立水錶安裝於尚築每層住宅樓層之水錶箱內。 每戶住宅單位之獨立電錶安裝於尚築每層住宅樓層之電掣房內。 不設氣體錶。

5. 保安設施	
細項	描述
保安系統及設備	地下入口大堂、升降機、地庫停車場、康樂設施、地下緊急車輛通道及邊界圍牆均裝設有閉路電視，並連接管理員辦事處。 訪客對講系統裝設於尚築地下入口並連接該尚築各單位內之對講機。

6. 設備	
細項	描述
設備	品牌名稱及產品型號：有關裝置和設備的品牌及產品型號，請參考“設備說明表”。

備註：

- 除部分隱藏於混凝土內之導管外，其他部分的導管均為外露。外露的導管可能被假天花、假陣、貯存櫃、覆面、非混凝土間牆、指定之槽位或其他物料遮蓋。

67A, 67B, 69A and 69B Tan Kwai Tsuen Road, Casa Regalia

The Vendor undertakes that if lifts or appliances of the specified brand name or model number are not installed in the Development, lifts or appliances of comparable quality will be installed.

1. Exterior Finishes	
Item	Description
(a) External Wall	Finished with natural stone cladding panels, curtain walls, paint, aluminum claddings and artificial granite tiles.
(b) Window	PVF2 aluminum window frames fitted with grey tinted glass for living room, dining room, kitchen, master bedroom and bedroom; PVF2 aluminum window frames fitted with obscured grey tinted glass for master bathroom and bathroom.
(c) Bay Window	Nil
(d) Planter	Externally finished with ceramic tiles.
(e) Verandah or balcony	Wall is finished with natural stone cladding and aluminum cladding. Floor is finished with homogenous tiles and natural stone tile curb. Exposed surfaces of ceilings of balcony are painted with emulsion paint. Fitted with glass balustrade. Balconies are covered. There is no verandah.
(f) Drying facilities for clothing	Nil

2. Interior Finishes	
Item	Description
(a) Lobby	Nil
(b) Internal wall and ceiling	Internal Walls: Exposed surfaces of internal walls of living room, dining room, master bedroom and bedroom, are painted with emulsion paint. Ceilings: Exposed surfaces of ceilings of living room, dining room, master bedroom and bedroom are finished with emulsion paint. Some areas are equipped with gypsum board false ceilings with emulsion paint.
(c) Internal floor	Living room, dining room, master bedroom and bedroom are finished with engineering timber flooring and timber skirting with natural stone tiles adjoining sliding doors to balconies, gardens or flat roofs.
(d) Bathroom	Master bathroom and bathroom: Exposed surfaces of walls are finished with ceramic tiles and mirror. Exposed surfaces of floor are finished with ceramic tiles. Gypsum board false ceilings with emulsion paint are provided. Wall finishes run up to false ceiling.
(e) Kitchen	Exposed surfaces of walls are finished with mirror and ceramic tiles up to false ceiling level. Exposed surfaces of floors are finished with ceramic tiles. Gypsum board false ceiling painted with emulsion paint are provided. Cooking bench top is fitted with artificial solid surface work top. Wall finishes run up to false ceiling.

3. Interior Fittings	
Item	Description
(a) Doors	<p>Rain Door at G/F Entrance : PVF2 aluminum framed glass door fitted with lockset.</p> <p>Main Entrance at G/F: Solid core timber door finished with timber veneer and fitted with lockset, door closer, eye viewer and door stopper.</p> <p>Entrance of House at B/F: Solid core timber door finished with timber veneer and fitted with lockset, door closer, door stopper.</p> <p>Door adjacent to staircase at B/F: Solid core timber door finished with timber veneer and fitted with door closer and door stopper.</p> <p>Kitchen: Solid core timber door finished with timber veneer and fitted with glass panel, door closer and door stopper.</p> <p>Master Bedroom, Bedroom, Master Bathroom, Bathroom, Guest Lavatory and Store Room 1: Hollow core timber door finished with timber veneer and fitted with lockset and door stopper. The doors of master bathroom, bathroom and guest lavatory are fitted with louvers.</p> <p>Store Room 2: Aluminum framed glass folding door.</p> <p>F.S. Pump Room: Solid core timber door finished with plastic laminate and fitted with lockset, door closer and door stopper.</p> <p>Hose Reel Door: Timber door panel with finished timber veneer.</p> <p>Garden, Balcony and Flat Roof: Sliding glass door with PVF2 aluminum frame fitted with lockset.</p> <p>Roof Door: PVF2 aluminum framed glass door with lockset.</p>

67A, 67B, 69A and 69B Tan Kwai Tsuen Road, Casa Regalia

3. Interior Fittings	
Item	Description
(b) Bathroom	<p>Master Bathroom and bathroom are fitted with wooden mirror cabinet. All countertops are finished with artificial solid surface material. Fittings and equipment include vitreous china water closet, vitreous china wash basin, chrome plated towel bar and paper holder. Ventilation fan is provided. Copper pipes are used for cold water supply system and copper water pipes with thermal insulation for hot water supply.</p> <p>Master bathroom and bathroom are fitted with enameled cast iron bath tub (1500mm L x 750mm W x 420mm H) with chrome plated bath mixer and shower bar.</p> <p>Shower cubicle fitted with chrome plated shower mixer are provided in master bathroom.</p> <p>For brand name and provisions of appliances, please refer to “Appliances Schedule”.</p>
(c) Kitchen	<p>Kitchen cabinet is completed with chipboard carcass, high gloss lacquered surface door frontal and high gloss high pressure laminated surface door panel, and equipped with artificial solid surface work top, stainless steel sink and chrome plated sink mixer. Copper pipes are used for cold water supply system and copper water pipes with thermal insulation for hot water supply.</p> <p>For brand name and provisions of appliances, please refer to “Appliances Schedule”.</p>
(d) Bedroom	Nil
(e) Telephone	<p>Telephone connection points are provided for living room, dining room, master bedroom and bedroom.</p> <p>For location and number of connection points, please refer to the “Schedule of Mechanical & Electrical Provisions” .</p>
(f) Aerials	<p>TV/FM outlets for local TV/FM radio programmes are provided in living room, dining room, kitchen, master bedroom, bedroom and master bathroom.</p> <p>For location and number of connection points, please refer to the “Schedule of Mechanical & Electrical Provisions” .</p>
(g) Electrical Installations	<p>Three-phase electricity supply with miniature circuit breakers distribution boards completed with residual-current device is provided. Conduit wiring concealed in walls or enclosed in false ceilings or bulkheads or cabinets for lightings and power points are provided.</p> <p>For location and number of socket points and air conditioner points, please refer to the “Schedule of Mechanical & Electrical Provisions” .</p>
(h) Gas Supply	<p>Town gas supply pipes are provided and connected to gas cooking hob and gas water heater. Gas meter connection point is located in the kitchen of each residential house.</p>
(i) Washing Machine Connection Point	<p>Drain point and water point are located in the kitchen.</p>
(j) Water Supply	<p>Copper water pipes are provided for cold water supply and copper water pipes with thermal insulation are provided for hot water supply.</p> <p>Hot water supply system is provided to kitchen and bathroom.</p> <p>Both hot and cold water pipes are partly concealed and partly exposed. ¹</p>

4. Miscellaneous	
Item	Description
(a) Lifts	Nil
(b) Letter Box	Metal letter box is provided for each individual house.
(c) Refuse Collection	A common refuse storage and material recovery chamber with vehicular access is provided at G/F for collection of refuse.
(d) Water Meter, Electricity Meter and Gas Meter	Separate water meter for each individual house is provided at water meter cabinet at B/F. Separate electricity meter for each individual house is provided at electricity meter cabinet at B/F. Space for separate gas meter is provided in the kitchen of each individual house.

5. Security Facilities	
Item	Description
Security System and Equipment	<p>CCTV cameras are installed at B/F car park, recreational facilities, emergency vehicular access at G/F and boundary fence walls are connected to the caretaker’s office.</p> <p>Visitor panel for access control is provided at G/F entrance of each individual house connecting to video door phone of each individual house.</p>

6. Appliances	
Item	Description
Appliances	For brand names and model numbers of appliances provided, please refer to the “Appliances Schedule”.

Notes:

- Other than those parts of the water pipes concealed with concrete, the rest of them are exposed. The exposed water pipes may be covered or hidden by false ceilings, bulkheads, cabinets, claddings, non-concrete partition walls, designated pipe ducts or other materials.

富豪·悅庭丹桂村路67A、67B、69A及69B號

賣方承諾如項目中沒有安裝指明的品牌名稱或產品型號的升降機或設備，便會安裝品質相若的升降機或設備。

1. 外部裝修物料	
細項	描述
(a) 外牆	鋪砌天然石材板、玻璃幕牆、油漆、鋁板及衍石磚。
(b) 窗	客廳、飯廳、廚房、主人睡房及睡房採用氟炭噴塗鋁窗框連灰面玻璃。 主人浴室及浴室選用氟炭噴塗鋁窗框連半透光灰面玻璃。
(c) 窗台	沒有。
(d) 花槽	花槽外鋪砌瓷磚。
(e) 陽台或露台	牆身鋪砌天然石材板及鋁板，地台鋪砌均質瓷磚及天然石墜，露台外露天花髹上乳膠漆。裝有玻璃欄杆。 為有蓋露台。 沒有陽台。
(f) 乾衣設施	沒有。

2. 室內裝修物料	
細項	描述
(a) 大堂	沒有。
(b) 內牆及天花板	內牆： 客廳、飯廳、主人睡房及睡房內外露牆髹乳膠漆。 天花板： 客廳、飯廳、主人睡房及睡房的天花板外露部份髹上乳膠漆，部分天花以石膏板鋪砌髹上乳膠漆。
(c) 內部地板	客廳、飯廳、主人睡房及睡房內部地板鋪砌複合木地板及木腳線。露台花園或天台沿趟門之地台圍邊部分鋪砌天然石材。
(d) 浴室	主人浴室及浴室外露牆身鋪砌瓷磚及玻璃鏡面。外露地台鋪砌瓷磚。裝設石膏板假天花髹上乳膠漆。牆身飾面鋪砌至假天花高度。
(e) 廚房	外露牆身鋪砌瓷磚及玻璃鏡面。外露地台鋪砌瓷磚。裝設石膏板假天花髹上乳膠漆。灶台面為實心人造面板枱面。牆身飾面鋪砌至假天花高度。

3. 室內裝置	
細項	描述
(a) 門	地下防雨門： 氟炭噴塗鋁門框玻璃門，裝設門鎖。 地下單位大門： 木皮面實心木門。裝設門鎖、氣鼓、防盜眼及門阻。 地庫單位大門： 木皮面實心木門。裝設門鎖、氣鼓及門阻。 地庫樓梯旁木門： 木皮面實心木門。裝設氣鼓及門阻。 廚房： 木皮面實心木門配以玻璃。裝設氣鼓及門阻。 主人睡房、睡房、主人浴室、浴室、客人洗手間及儲物室 1： 木皮面空心木門。裝設門鎖及門阻。主人浴室，浴室及客人洗手間門設有百葉。 儲物室 2： 鋁門框玻璃摺門。 消防泵房： 膠板面實心木門。裝設門鎖、氣鼓及門阻。 消防喉轆門： 木皮面木門。 花園、露台及平台： 氟炭噴塗鋁框玻璃趟門，裝設門鎖。 天台門： 氟炭噴塗鋁門框玻璃門，裝設門鎖。
(b) 浴室	主人浴室及浴室選用木面鏡櫃。主人浴室及浴室選用實心人造面板檯面。裝置及設備包括陶瓷坐廁、陶瓷洗手盆、鍍鉻飾面毛巾架及廁紙架。設有抽氣扇。冷水喉採用銅喉管，熱水喉採用隔熱絕緣銅喉。 主人浴室及浴室設有瓷釉鑄鐵浴缸 (1500 毫米長 x 750 毫米闊 x 420 毫米高)，鍍鉻浴缸水龍頭及花灑水龍頭。 主人浴室淋浴間設有鍍鉻花灑水龍頭。 隨樓附送之設備及品牌，請參閱“設備說明表”。
(c) 廚房	廚櫃由高級刨花板櫃體、高光烤漆櫃門和高光高壓耐高溫飾面板櫃門組成；並配有實心人造面板檯面、不銹鋼水槽和鍍鉻單控水龍頭。冷水喉採用銅喉管，熱水喉採用隔熱絕緣銅喉。 隨樓附送之設備及品牌，請參閱“設備說明表”。
(d) 睡房	沒有。

富豪·悅庭丹桂村路67A、67B、69A及69B號

3. 室內裝置	
細項	描述
(e) 電話	客廳、飯廳、主人睡房及睡房設有電話插座。 有關接駁點的位置及數量，請參考“機電裝置數量說明表”。
(f) 天線	客廳、飯廳、廚房、主人睡房、睡房及主人浴室均裝設有可接收本地電視節目及電台節目的電視 / 收音機天線插座。 有關接駁點的位置及數量，請參考“機電裝置數量說明表”。
(g) 電力裝置	提供三相電力配電箱並裝置有漏電斷路器。照明及電插座之導管暗藏於牆身或置於假天花、假陣或櫃內。 有關電插座及空調機接駁點的位置及數量，請參考“機電裝置數量說明表”。
(h) 氣體供應	煤氣喉接駁煤氣煮食爐及煤氣熱水爐。單位之煤氣錶接駁點位於廚房內。
(i) 洗衣機接駁點	洗衣機配備來水及去水接駁點設在廚房內。
(j) 供水	冷水喉採用銅喉及熱水喉採用配有隔熱絕緣保護之銅喉。 廚房及浴室有熱水供應。 冷熱水管是部分隱藏及部分外露。 ¹

4. 雜項	
細項	描述
(a) 升降機	沒有。
(b) 信箱	每座洋房設置金屬信箱。
(c) 垃圾收集	一個設有車輛通道公用垃圾儲存及物料回收房位於地下提供垃圾收集處理。
(d) 水錶、電錶及氣體錶	每座洋房之獨立水錶安裝於地庫水錶箱內。 每座洋房之獨立電錶安裝於地庫電錶箱內。 每座洋房之廚房內預留獨立煤氣錶位置。

5. 保安設施	
細項	描述
保安系統及設備	地庫停車場、康樂設施、地下緊急車輛通道及邊界圍牆均裝設有閉路電視，並連接管理員辦事處。 每座洋房地下入口裝有訪客視像對講機並連接該洋房內之視像對講機。

6. 設備	
細項	描述
設備	品牌名稱及產品型號：有關裝置和設備的品牌及產品型號，請參考“設備說明表”。

備註：

- 除部分隱藏於混凝土內之導管外，其他部分的導管均為外露。外露的導管可能被假天花、假陣、貯存櫃、覆面、非混凝土間牆、指定之槽位或其他物料遮蓋。

71A Tan Kwai Tsuen Road, Casa Regalia

The Vendor undertakes that if lifts or appliances of the specified brand name or model number are not installed in the Development, lifts or appliances of comparable quality will be installed.

1. Exterior Finishes	
Item	Description
(a) External Wall	Finished with natural stone cladding panels, curtain walls, paint, aluminum claddings and artificial granite tiles.
(b) Window	PVF2 aluminum window frames fitted with grey tinted glass for living room, dining room, kitchen, master bedroom and bedroom; PVF2 aluminum window frames fitted with obscured grey tinted glass for master bathroom and bathroom.
(c) Bay Window	Nil
(d) Planter	Externally finished with ceramic tiles.
(e) Verandah or balcony	Wall is finished with natural stone cladding and aluminum cladding. Floor is finished with homogenous tiles and natural stone tile curb. Exposed surfaces of ceilings of balcony are painted with emulsion paint. Fitted with glass balustrade. Balconies are covered. There is no verandah.
(f) Drying facilities for clothing	Nil

2. Interior Finishes	
Item	Description
(a) Lobby	Nil
(b) Internal wall and ceiling	Internal Walls: Exposed surfaces of internal walls of living room, dining room, master bedroom and bedroom are painted with emulsion paint and glass panel, wallpaper, natural stone tiles, wooden and fabric panel. Ceilings: Exposed surfaces of ceilings of living room, dining room, master bedroom and bedroom are finished with emulsion paint. Some areas are equipped with gypsum board false ceilings with emulsion paint.
(c) Internal floor	Living room, dining room, master bedroom and bedroom are finished with engineering timber flooring and timber skirting, natural stone tiles and ceramic tiles with natural stone tiles adjoining sliding doors to balconies, gardens or flat roofs.
(d) Bathroom	Master bathroom and bathroom: Exposed surfaces of walls are finished with ceramic tiles, mirror and natural stone tiles. Exposed surfaces of floor are finished with ceramic tiles or natural stone tiles. Gypsum board false ceilings with emulsion paint are provided. Wall finishes run up to false ceiling.
(e) Kitchen	Exposed surfaces of walls are finished with mirror and ceramic tiles up to false ceiling level. Exposed surfaces of floors are finished with ceramic tiles. Gypsum board false ceiling painted with emulsion paint are provided. Cooking bench top is fitted with artificial solid surface work top. Wall finishes run up to false ceiling.

3. Interior Fittings	
Item	Description
(a) Doors	<p>Rain Door at G/F Entrance : PVF2 aluminum framed glass door fitted with lockset.</p> <p>Main Entrance at G/F: Solid core timber door finished with timber veneer and fitted with lockset, door closer, eye viewer and door stopper.</p> <p>Entrance of House at B/F: Solid core timber door finished with timber veneer and fitted with lockset, door closer, door stopper.</p> <p>Door adjacent to staircase at B/F: Solid core timber door finished with timber veneer and fitted with door closer and door stopper.</p> <p>Kitchen: Solid core timber door finished with timber veneer and fitted with door closer and door stopper.</p> <p>Master Bedroom, Bedroom: Solid core timber door with timber veneer and fitted with lockset</p> <p>Master Bathroom: Glass door</p> <p>Bathroom: Hollow core timber door finished with timber veneer and fitted with louvers and lockset</p> <p>Guest Lavatory: Hollow core timber door finished with timber veneer and mirror.</p> <p>Store Room 1: Solid core timber sliding door</p> <p>Lavatory adjacent Store Room 1: Aluminum framed glass folding door.</p> <p>F.S. Pump Room: Solid core timber door finished with plastic laminate and fitted with lockset, door closer and door stopper.</p> <p>Hose Reel Door: Timber door panel finished with wallpaper.</p> <p>Garden, Balcony and Flat Roof: Sliding glass door with PVF2 aluminum frame fitted with lockset.</p> <p>Roof Door: PVF2 aluminum framed glass door with lockset.</p>
(b) Bathroom	<p>Master Bathroom and bathroom are fitted with wooden mirror cabinet. All countertops are finished with natural stone. Fittings and equipment include vitreous china water closet, vitreous china wash basin, natural stone wash basin, chrome plated towel bar and paper holder. Ventilation fan is provided. Copper pipes are used for cold water supply system and copper water pipes with thermal insulation for hot water supply.</p> <p>Master bathroom and bathroom are fitted with enameled cast iron bath tub (1500mm L x 750mm W x 420mm H) and free stand bathtub with chrome plated bath mixer and shower bar. Shower cubicle fitted with chrome plated shower water mixer are provided in master bathroom. For brand name and provisions of appliances, please refer to "Appliances Schedule".</p>

71A Tan Kwai Tsuen Road, Casa Regalia

3. Interior Fittings	
Item	Description
(c) Kitchen	Kitchen cabinet is completed with chipboard carcass, high gloss lacquered surface door frontal and high gloss high pressure laminated surface door panel, and equipped with artificial solid surface work top, stainless steel sink and chrome plated sink mixer. Copper pipes are used for cold water supply system and copper water pipes with thermal insulation for hot water supply. For brand name and provisions of appliances, please refer to “Appliances Schedule”.
(d) Bedroom	Nil
(e) Telephone	Telephone connection points are provided for living room, dining room, master bedroom and bedroom. For location and number of connection points, please refer to the “Schedule of Mechanical & Electrical Provisions”.
(f) Aerials	TV/FM outlets for local TV/FM radio programmes are provided in living room, dining room, kitchen, master bedroom, bedroom and master bathroom. For location and number of connection points, please refer to the “Schedule of Mechanical & Electrical Provisions”.
(g) Electrical Installations	Three-phase electricity supply with miniature circuit breakers distribution boards completed with residual-current device is provided. Conduit wiring concealed in walls or enclosed in false ceilings or bulkheads or cabinets for lightings and power points are provided. For location and number of socket points and air conditioner points, please refer to the “Schedule of Mechanical & Electrical Provisions”.
(h) Gas Supply	Town gas supply pipes are provided and connected to gas cooking hob and gas water heater. Gas meter connection point is located in the kitchen of each individual house.
(i) Washing Machine Connection Point	Drain point and water point are located in the kitchen.
(j) Water Supply	Copper water pipes are provided for cold water supply and copper water pipes with thermal insulation are provided for hot water supply. Hot water supply system is provided to kitchen and bathroom. Both hot and cold water pipes are partly concealed and partly exposed. ¹

4. Miscellaneous	
Item	Description
(a) Lifts	Nil
(b) Letter Box	Metal letter box is provided for each individual house.
(c) Refuse Collection	A common refuse storage and material recovery chamber with vehicular access is provided at G/F for collection of refuse.
(d) Water Meter, Electricity Meter and Gas Meter	Separate water meter for each individual house is provided at water meter cabinet at B/F. Separate electricity meter for each individual house is provided at electricity meter cabinet at B/F. Space for separate gas meter is provided in the kitchen of each individual house.

5. Security Facilities	
Item	Description
Security System and Equipment	CCTV cameras are installed at B/F car park, recreational facilities, emergency vehicular access at G/F and boundary fence walls are connected to the caretaker’s office. Visitor panel for access control is provided at G/F entrance of each individual house connecting to video door phone of each individual house.

6. Appliances	
Item	Description
Appliances	For brand names and model numbers of appliances provided, please refer to the “Appliances Schedule”.

Notes:

- Other than those parts of the water pipes concealed with concrete, the rest of them are exposed. The exposed water pipes may be covered or hidden by false ceilings, bulkheads, cabinets, claddings, non-concrete partition walls, designated pipe ducts or other materials.

富豪·悅庭丹桂村路71A號

賣方承諾如項目中沒有安裝指明的品牌名稱或產品型號的升降機或設備，便會安裝品質相若的升降機或設備。

1. 外部裝修物料	
細項	描述
(a) 外牆	鋪砌天然石材板、玻璃幕牆、油漆、鋁板及衍石磚。
(b) 窗	客廳、飯廳、廚房、主人睡房及睡房採用氟炭噴塗鋁窗框連灰面玻璃。 主人浴室及浴室選用氟炭噴塗鋁窗框連半透光灰面玻璃。
(c) 窗台	沒有。
(d) 花槽	花槽外鋪砌瓷磚。
(e) 陽台或露台	牆身鋪砌天然石材板及鋁板，地台鋪砌均質瓷磚及天然石壘，露台外露天花鬆上乳膠漆。裝有玻璃欄杆。 為有蓋露台。 沒有陽台。
(f) 乾衣設施	沒有。

2. 室內裝修物料	
細項	描述
(a) 大堂	沒有。
(b) 內牆及天花板	內牆： 客廳、飯廳、主人睡房及睡房內外露牆髹乳膠漆，部分牆身鋪砌玻璃、牆紙、天然石材、木及布料裝飾板。 天花板： 客廳、飯廳、主人睡房及睡房的天花板外露部份髹上乳膠漆，部分天花以石膏板鋪砌髹上乳膠漆。
(c) 內部地板	客廳、飯廳、主人睡房及睡房內部地板鋪砌瓷磚、天然石材、複合木地板及木腳線。露台、花園或天台沿趟門之地台圍邊部分鋪砌天然石材。
(d) 浴室	主人浴室及浴室外牆身鋪砌瓷磚、玻璃鏡面及天然石材。外露台鋪砌瓷磚或天然石材。裝設石膏板假天花髹上乳膠漆。牆身飾面鋪砌至假天花高度。
(e) 廚房	外牆身鋪砌瓷磚及玻璃鏡面。外露台鋪砌瓷磚。裝設石膏板假天花髹上乳膠漆。灶台面為實心人造面板枱面。牆身飾面鋪砌至假天花高度。

3. 室內裝置	
細項	描述
(a) 門	地下防雨門： 氟炭噴塗鋁門框玻璃門，裝設門鎖。 地下單位大門： 木皮面實心木門。裝設門鎖、氣鼓、防盜眼及門阻。 地庫單位大門： 木皮面實心木門。裝設門鎖、氣鼓及門阻。 地庫樓梯旁木門： 木皮面實心木門。裝設氣鼓及門阻。 廚房： 木皮面實心木門。裝設氣鼓及門阻。 主人睡房、睡房： 木皮面實心木門。裝設門鎖。 主人浴室： 玻璃門。 浴室： 木皮面空心木門，設有百葉。裝設門鎖。 客人洗手間： 木皮面及玻璃鏡面空心木門。 儲物室 1： 木皮面實心趟門。 儲物室 1 旁廁所： 鋁門框玻璃摺門。 消防泵房： 膠板面實心木門。裝設門鎖、氣鼓及門阻。 消防喉轆門： 牆紙飾面木門。 花園、露台及平台： 氟炭噴塗鋁框玻璃趟門，裝設門鎖。 天台門： 氟炭噴塗鋁門框玻璃門，裝設門鎖。
(b) 浴室	主人浴室及浴室選用木面鏡櫃。主人浴室及浴室選用天然石材檯面。裝置及設備包括陶瓷坐廁、陶瓷洗手盆、天然石材洗手盆、鍍鉻飾面毛巾架及廁紙架。設有抽氣扇。冷水喉採用銅喉管，熱水喉採用隔熱絕緣銅喉。 主人浴室及浴室設有瓷釉鑄鐵浴缸（1500 毫米長 x 750 毫米闊 x 420 毫米高），石材貴妃浴缸、鍍鉻浴缸水龍頭及花灑水龍頭。 主人浴室淋浴間設有鍍鉻花灑水龍頭。 隨樓附送之設備及品牌，請參閱“設備說明表”。

富豪·悅庭丹桂村路71A號

3. 室內裝置	
細項	描述
(c) 廚房	廚櫃由高級刨花板櫃體、高光烤漆櫃門和高光高壓耐高溫飾面板櫃門組成；並配有實心人造面板檯面、不銹鋼水槽和鍍鉻單控水龍頭。冷水喉採用銅喉管，熱水喉採用隔熱絕緣銅喉。 隨樓附送之設備及品牌，請參閱“設備說明表”。
(d) 睡房	沒有。
(e) 電話	客廳、飯廳、主人睡房及睡房設有電話插座。 有關接駁點的位置及數量，請參考“機電裝置數量說明表”。
(f) 天線	客廳、飯廳、廚房、主人睡房、睡房及主人浴室均裝設有可接收本地電視節目及電台節目的電視 / 收音機天線插座。 有關接駁點的位置及數量，請參考“機電裝置數量說明表”。
(g) 電力裝置	提供三相電力配電箱並裝置有漏電斷路器。照明及電插座之導管暗藏於牆身或置於假天花、假陣或櫃內。 有關電插座及空調機接駁點的位置及數量，請參考“機電裝置數量說明表”。
(h) 氣體供應	煤氣喉接駁煤氣煮食爐及煤氣熱水爐。單位之煤氣錶接駁點位於廚房內。
(i) 洗衣機接駁點	洗衣機配備來水及去水接駁點設在廚房。
(j) 供水	冷水喉採用銅喉及熱水喉採用配有隔熱絕緣保護之銅喉。 廚房及浴室有熱水供應。 冷熱水管是部分隱藏及部分外露。 ¹

4. 雜項	
細項	描述
(a) 升降機	沒有。
(b) 信箱	每座洋房設置金屬信箱。
(c) 垃圾收集	一個設有車輛通道公用垃圾儲存及物料回收房位於地下提供垃圾收集處理。
(d) 水錶、電錶及氣體錶	每座洋房之獨立水錶安裝於地庫水錶箱內。 每座洋房之獨立電錶安裝於地庫電錶箱內。 每座洋房之廚房內預留獨立煤氣錶位置。

5. 保安設施	
細項	描述
保安系統及設備	地庫停車場、康樂設施、地下緊急車輛通道及邊界圍牆均裝設有閉路電視，並連接管理員辦事處。 每座洋房地下入口裝有訪客視像對講機並連接該洋房內之視像對講機。

6. 設備	
細項	描述
設備	品牌名稱及產品型號：有關裝置和設備的品牌及產品型號，請參考“設備說明表”。

備註：

- 除部分隱藏於混凝土內之導管外，其他部分的導管均為外露。外露的導管可能被假天花、假陣、貯存櫃、覆面、非混凝土間牆、指定之槽位或其他物料遮蓋。

71B, 73A and 73B Tan Kwai Tsuen Road, Casa Regalia

The Vendor undertakes that if lifts or appliances of the specified brand name or model number are not installed in the Development, lifts or appliances of comparable quality will be installed.

1. Exterior Finishes	
Item	Description
(a) External Wall	Finished with natural stone cladding panels, curtain walls, paint, aluminum claddings and artificial granite tiles.
(b) Window	PVF2 aluminum window frames fitted with grey tinted glass for living room, dining room, kitchen, master bedroom and bedroom; PVF2 aluminum window frames fitted with obscured grey tinted glass for master bathroom and bathroom.
(c) Bay Window	Nil
(d) Planter	Externally finished with ceramic tiles.
(e) Verandah or balcony	Wall is finished with natural stone cladding and aluminum cladding. Floor is finished with homogenous tiles and natural stone tile curb. Exposed surfaces of ceilings of balcony are painted with emulsion paint. Fitted with glass balustrade. Balconies are covered. There is no verandah.
(f) Drying facilities for clothing	Nil

2. Interior Finishes	
Item	Description
(a) Lobby	Nil
(b) Internal wall and ceiling	Internal Walls: Exposed surfaces of internal walls of living room, dining room, master bedroom and bedroom are painted with emulsion paint. Ceilings: Exposed surfaces of ceilings of living room, dining room, master bedroom and bedroom are finished with emulsion paint. Some areas are equipped with gypsum board false ceilings with emulsion paint.
(c) Internal floor	Living room, dining room, master bedroom and bedroom are finished with engineering timber flooring and timber skirting with natural stone tiles adjoining sliding doors to balconies, gardens or flat roofs.
(d) Bathroom	Master bathroom and bathroom: Exposed surfaces of walls are finished with ceramic tiles and mirror. Exposed surfaces of floor are finished with ceramic tiles. Gypsum board false ceilings with emulsion paint are provided. Wall finishes run up to false ceiling.
(e) Kitchen	Exposed surfaces of walls are finished with mirror and ceramic tiles up to false ceiling level. Exposed surfaces of floors are finished with ceramic tiles. Gypsum board false ceiling painted with emulsion paint are provided. Cooking bench top is fitted with artificial solid surface work top. Wall finishes run up to false ceiling.

3. Interior Fittings	
Item	Description
(a) Doors	Rain Door at G/F Entrance : PVF2 aluminum framed glass door fitted with lockset. Main Entrance at G/F: Solid core timber door finished with timber veneer and fitted with lockset, door closer, eye viewer and door stopper. Entrance of House at B/F: Solid core timber door finished with timber veneer and fitted with lockset, door closer, door stopper. Door adjacent to staircase at B/F: Solid core timber door finished with timber veneer and fitted with door closer and door stopper. Kitchen: Solid core timber door finished with timber veneer and fitted with glass panel, door closer and door stopper. Master Bedroom, Bedroom, Master Bathroom, Bathroom, Guest Lavatory and Store Room 1: Hollow core timber door finished with timber veneer and fitted with lockset and door stopper. The doors of master bathroom and guest lavatory are fitted with louvers. Store Room 2: Aluminum framed glass folding door. F.S. Pump Room: Solid core timber door finished with plastic laminate and fitted with lockset, door closer and door stopper. Hose Reel Door: Timber door panel finished with timber veneer. Garden, Balcony and Flat Roof: Sliding glass door with PVF2 aluminum frame fitted with lockset. Roof Door: PVF2 aluminum framed glass door with lockset.
(b) Bathroom	Master Bathroom and bathroom are fitted with wooden mirror cabinet. All countertops are finished with artificial solid surface material. Fittings and equipment include vitreous china water closet, vitreous china wash basin, chrome plated towel bar and paper holder. Ventilation fan is provided. Copper pipes are used for cold water supply system and copper water pipes with thermal insulation for hot water supply. Master bathroom and bathroom are fitted with enameled cast iron bath tub (1500mm L x 750mm W x 420mm H) with chrome plated bath mixer and shower bar. Shower cubicle fitted with chrome plated shower water mixer are provided in master bathroom. For brand name and provisions of appliances, please refer to "Appliances Schedule".
(c) Kitchen	Kitchen cabinet is completed with chipboard carcass, high gloss lacquered surface door frontal and high gloss high pressure laminated surface door panel, and equipped with artificial solid surface work top, stainless steel sink and chrome plated sink mixer. Copper pipes are used for cold water supply system and copper water pipes with thermal insulation for hot water supply. For brand name and provisions of appliances, please refer to "Appliances Schedule".
(d) Bedroom	Nil
(e) Telephone	Telephone connection points are provided for living room, dining room, master bedroom and bedroom. For location and number of connection points, please refer to the "Schedule of Mechanical & Electrical Provisions".

71B, 73A and 73B Tan Kwai Tsuen Road, Casa Regalia

3. Interior Fittings	
Item	Description
(f) Aerials	TV/FM outlets for local TV/FM radio programmes are provided in living room, dining room, kitchen, master bedroom, bedroom and master bathroom. For location and number of connection points, please refer to the “Schedule of Mechanical & Electrical Provisions”.
(g) Electrical Installations	Three-phase electricity supply with miniature circuit breakers distribution boards completed with residual-current device is provided. Conduit wiring concealed in walls or enclosed in false ceilings or bulkheads or cabinets for lightings and power points are provided. For location and number of socket points and air conditioner points, please refer to the “Schedule of Mechanical & Electrical Provisions”.
(h) Gas Supply	Town gas supply pipes are provided and connected to gas cooking hob and gas water heater. Gas meter connection point is located in the kitchen of each individual house.
(i) Washing Machine Connection Point	Drain point and water point are located in the kitchen.
(j) Water Supply	Copper water pipes are provided for cold water supply and copper water pipes with thermal insulation are provided for hot water supply. Hot water supply system is provided to kitchen and bathroom. Both hot and cold water pipes are partly concealed and partly exposed. ¹

4. Miscellaneous	
Item	Description
(a) Lifts	Nil
(b) Letter Box	Metal letter box is provided for each individual house.
(c) Refuse Collection	A common refuse storage and material recovery chamber with vehicular access is provided at G/F for collection of refuse.
(d) Water Meter, Electricity Meter and Gas Meter	Separate water meter for each individual house is provided at water meter cabinet at B/F. Separate electricity meter for each individual house is provided at electricity meter cabinet at B/F. Space for separate gas meter is provided in the kitchen of each individual house.

5. Security Facilities	
Item	Description
Security System and Equipment	CCTV cameras are installed at B/F car park, recreational facilities, emergency vehicular access at G/F and boundary fence walls are connected to the caretaker’s office. Visitor panel for access control is provided at G/F entrance of each individual house connecting to video door phone of each individual house.

6. Appliances	
Item	Description
Appliances	For brand names and model numbers of appliances provided, please refer to the “Appliances Schedule”.

Notes:

- Other than those parts of the water pipes concealed with concrete, the rest of them are exposed. The exposed water pipes may be covered or hidden by false ceilings, bulkheads, cabinets, claddings, non-concrete partition walls, designated pipe ducts or other materials.

富豪·悅庭丹桂村路71B、73A及73B號

賣方承諾如項目中沒有安裝指明的品牌名稱或產品型號的升降機或設備，便會安裝品質相若的升降機或設備。

1. 外部裝修物料	
細項	描述
(a) 外牆	鋪砌天然石材板、玻璃幕牆、油漆、鋁板及衍石磚。
(b) 窗	客廳、飯廳、廚房、主人睡房及睡房採用氟炭噴塗鋁窗框連灰面玻璃。 主人浴室及浴室選用氟炭噴塗鋁窗框連半透光灰面玻璃。
(c) 窗台	沒有。
(d) 花槽	花槽外鋪砌瓷磚。
(e) 陽台或露台	牆身鋪砌天然石材板及鋁板，地台鋪砌均質瓷磚及天然石墜，露台外露天花鬆上乳膠漆。裝有玻璃欄杆。 為有蓋露台。 沒有陽台。
(f) 乾衣設施	沒有。

2. 室內裝修物料	
細項	描述
(a) 大堂	沒有。
(b) 內牆及天花板	內牆： 客廳、飯廳、主人睡房及睡房內外露牆髹乳膠漆。 天花板： 客廳、飯廳、主人睡房及睡房的天花板外露部份髹上乳膠漆，部分天花以石膏板鋪砌髹上乳膠漆。
(c) 內部地板	客廳、飯廳、主人睡房及睡房內部地板鋪砌複合木地板及木腳線。露台、花園或天台沿趟門之地台圍邊部分鋪砌天然石材。
(d) 浴室	主人浴室及浴室外露牆身鋪砌瓷磚及玻璃鏡面。外露地台鋪砌瓷磚。裝設石膏板假天花髹上乳膠漆。牆身飾面鋪砌至假天花高度。
(e) 廚房	外露牆身鋪砌瓷磚及玻璃鏡面。外露地台鋪砌瓷磚。裝設石膏板假天花髹上乳膠漆。灶台面為實心人造面板枱面。牆身飾面鋪砌至假天花高度。

3. 室內裝置	
細項	描述
(a) 門	地下防雨門： 氟炭噴塗鋁門框玻璃門，裝設門鎖。 地下單位大門： 木皮面實心木門。裝設門鎖、氣鼓、防盜眼及門阻。 地庫單位大門： 木皮面實心木門。裝設門鎖、氣鼓及門阻。 地庫樓梯旁木門： 木皮面實心木門。裝設氣鼓及門阻。 廚房： 木皮面實心木門配以玻璃。裝設氣鼓及門阻。 主人睡房、睡房、主人浴室、浴室、客人洗手間及儲物室 1： 木皮面空心木門。裝設門鎖及門阻。主人浴室及客人洗手間門設有百葉。 儲物室 2： 鋁門框玻璃摺門。 消防泵房： 膠板面實心木門。裝設門鎖、氣鼓及門阻。 消防喉轆門： 木皮面木門。 花園、露台及平台： 氟炭噴塗鋁門框玻璃趟門，裝設門鎖。 天台門： 氟炭噴塗鋁門框玻璃門，裝設門鎖。
(b) 浴室	主人浴室及浴室選用木面鏡櫃。主人浴室及浴室選用實心人造面板檯面。裝置及設備包括陶瓷坐廁、陶瓷洗手盆、鍍鉻飾面毛巾架及廁紙架。設有抽氣扇。冷水喉採用銅喉管，熱水喉採用隔熱絕緣銅喉。 主人浴室及浴室設有瓷釉鑄鐵浴缸（1500 毫米長 x 750 毫米闊 x 420 毫米高），鍍鉻浴缸水龍頭及花灑水龍頭。 主人浴室淋浴間設有鍍鉻花灑水龍頭。 隨樓附送之設備及品牌，請參閱“設備說明表”。
(c) 廚房	廚櫃由高級刨花板櫃體、高光烤漆櫃門和高光高壓耐高溫飾面板櫃門組成；並配有實心人造面板檯面、不銹鋼水槽和鍍鉻單控水龍頭。冷水喉採用銅喉管，熱水喉採用隔熱絕緣銅喉。 隨樓附送之設備及品牌，請參閱“設備說明表”。
(d) 睡房	沒有。

富豪·悅庭丹桂村路71B、73A及73B號

3. 室內裝置	
細項	描述
(e) 電話	客廳、飯廳、主人睡房及睡房設有電話插座。 有關接駁點的位置及數量，請參考“機電裝置數量說明表”。
(f) 天線	客廳、飯廳、廚房、主人睡房、睡房及主人浴室均裝設有可接收本地電視節目及電台節目的電視 / 收音機天線插座。 有關接駁點的位置及數量，請參考“機電裝置數量說明表”。
(g) 電力裝置	提供三相電力配電箱並裝置有漏電斷路器。照明及電插座之導管暗藏於牆身或置於假天花、假陣或櫃內。 有關電插座及空調機接駁點的位置及數量，請參考“機電裝置數量說明表”。
(h) 氣體供應	煤氣喉接駁煤氣煮食爐及煤氣熱水爐。單位之煤氣錶接駁點位於廚房內。
(i) 洗衣機接駁點	洗衣機配備來水及去水接駁點設在廚房。
(j) 供水	冷水喉採用銅喉及熱水喉採用配有隔熱絕緣保護之銅喉。 廚房及浴室有熱水供應。 冷熱水管是部分隱藏及部分外露。 ¹

4. 雜項	
細項	描述
(a) 升降機	沒有。
(b) 信箱	每座洋房設置金屬信箱。
(c) 垃圾收集	一個設有車輛通道公用垃圾儲存及物料回收房位於地下提供垃圾收集處理。
(d) 水錶、電錶及氣體錶	每座洋房之獨立水錶安裝於地庫水錶箱內。 每座洋房之獨立電錶安裝於地庫電錶箱內。 每座洋房之廚房內預留獨立煤氣錶位置。

5. 保安設施	
細項	描述
保安系統及設備	地庫停車場、康樂設施、地下緊急車輛通道及邊界圍牆均裝設有閉路電視，並連接管理員辦事處。 每座洋房地下入口裝有訪客視像對講機並連接該洋房內之視像對講機。

6. 設備	
細項	描述
設備	品牌名稱及產品型號：有關裝置和設備的品牌及產品型號，請參考“設備說明表”。

備註：

- 除部分隱藏於混凝土內之導管外，其他部分的導管均為外露。外露的導管可能被假天花、假陣、貯存櫃、覆面、非混凝土間牆、指定之槽位或其他物料遮蓋。

75A Tan Kwai Tsuen Road, Casa Regalia

The Vendor undertakes that if lifts or appliances of the specified brand name or model number are not installed in the Development, lifts or appliances of comparable quality will be installed.

1. Exterior Finishes	
Item	Description
(a) External Wall	Finished with natural stone cladding panels, curtain walls, paint, aluminum claddings and artificial granite tiles.
(b) Window	PVF2 aluminum window frames fitted with grey tinted glass for living room, dining room, kitchen, master bedroom and bedroom; PVF2 aluminum window frames fitted with obscured grey tinted glass for master bathroom and bathroom.
(c) Bay Window	Nil
(d) Planter	Externally finished with ceramic tiles.
(e) Verandah or balcony	Wall is finished with natural stone cladding and aluminum cladding. Floor is finished with homogenous tiles and natural stone tile curb. Exposed surfaces of ceilings of balcony are painted with emulsion paint. Fitted with glass balustrade. Balconies are covered. There is no verandah.
(f) Drying facilities for clothing	Nil

2. Interior Finishes	
Item	Description
(a) Lobby	Nil
(b) Internal wall and ceiling	<p>Internal Walls:</p> <ul style="list-style-type: none"> - Exposed surfaces of internal walls of living and dining room are partly finished with tiles, partly finished with vinyl leather panel with mirror and stainless steel, partly painted with high gloss lacquer, and partly finished with marble. - Exposed surfaces of internal walls of master bedroom are partly finished with vinyl leather panel, partly finished with fabric panel, partly finished with mirror, and partly finished with laminate glass with stainless steel frame. - Exposed surfaces of internal walls of bedroom 1 are partly finished with fabric panel, vinyl leather panel and mirror, partly painted with high gloss lacquer. - Exposed surfaces of internal walls of bedroom 2 are partly finished with fabric panel and vinyl leather panel, partly finished with wallpaper, and partly finished with mirror. <p>Ceilings: Exposed surfaces of ceilings of living room, dining room, master bedroom and bedroom are finished with emulsion paint. Some areas are equipped with gypsum board false ceilings with emulsion paint. Part of master bedroom is finished with vinyl leather panel.</p>
(c) Internal floor	<p>Living and dining room are finished with ceramic tiles.</p> <p>Master bedroom, bedroom 1 and bedroom 2 are finished with engineering timber flooring with natural stone tiles adjoining sliding doors to balconies, gardens or flat roofs.</p> <p>Master bedroom and bedroom 1 are finished with stainless steel skirting, bedroom 2 are finished with high gloss lacquer skirting.</p>
(d) Bathroom	Master bathroom and bathroom: Exposed surfaces of walls are finished with ceramic tiles and mirror. Exposed surfaces of floor are finished with ceramic tiles. Gypsum board false ceilings with emulsion paint are provided for bathroom; stainless steel frame glass ceiling are provided for master bathroom. Wall finishes run up to false ceiling.
(e) Kitchen	Exposed surfaces of walls are finished with mirror and ceramic tiles up to false ceiling level. Exposed surfaces of floors are finished with ceramic tiles. Gypsum board false ceiling painted with emulsion paint are provided. Cooking bench top is fitted with artificial solid surface work top. Wall finishes run up to false ceiling.

3. Interior Fittings	
Item	Description
(a) Doors	<p>Rain Door at G/F Entrance : PVF2 aluminum framed glass door fitted with lockset.</p> <p>Main Entrance at G/F: Solid core timber door finished with timber veneer at one side and high gloss lacquer at another side and fitted with lockset, door closer, eye viewer and door stopper.</p> <p>Entrance of House at B/F: Solid core timber door finished with timber veneer and fitted with lockset, door closer, door stopper.</p> <p>Door adjacent to staircase at B/F: Solid core timber door finished with timber veneer and fitted door closer and door stopper.</p> <p>Kitchen: Aluminum frame with powder coat fire rated glass door fitted with door closer and door stopper.</p> <p>Master bedroom, bedroom 1: Hollow core timber door finished with high gloss lacquer and fitted with lockset and door stopper.</p> <p>Bedroom 2: Hollow core timber door finished with high gloss lacquer at one side and mirror at another side, and fitted with lockset and door stopper.</p> <p>Master bathroom: Laminate glass with stainless steel frame sliding door.</p> <p>Bathroom 1: Hollow core timber door finished with mirror and fitted with lockset and door stopper.</p> <p>Bathroom 2: Glass with stainless steel frame sliding door and fitted with lockset.</p> <p>Guest Lavatory: Hollow timber door finished with high gloss lacquer at one side and timber veneer at another side, and fitted with lockset and door stopper.</p> <p>Store Room 1: Hollow core timber door finished with wallpaper at one side and timber veneer at another side, and fitted with lockset and door stopper.</p> <p>Lavatory adjacent Store Room 1: Aluminum framed glass folding door.</p> <p>F.S. Pump Room: Solid core timber door finished with timber veneer and fitted with lockset, door closer and door stopper.</p> <p>Hose Reel Door (G/F): Timber door panel finished with high gloss lacquer.</p> <p>Hose Reel Door (1/F): Timber door panel finished with wallpaper.</p> <p>Hose Reel Door (2/F): Metal frame door finished with ceramic tiles.</p> <p>Garden, Balcony and Flat Roof: Sliding glass door with PVF2 aluminum frame fitted with lockset.</p> <p>Roof Door: PVF2 aluminum framed glass door with lockset.</p>

75A Tan Kwai Tsuen Road, Casa Regalia

3. Interior Fittings	
Item	Description
(b) Bathroom	<p>Master Bathroom and bathroom 2 are fitted with wooden mirror cabinet. Bathroom 1 is fitted with sliding mirror. All countertops are finished with marble. Fittings and equipment include vitreous china water closet, chrome plate basin mixer, chrome plated towel ring and paper holder. Master bathroom is fitted with vitreous china wash basin. Bathroom 1 and 2 are fitted with Aluminum Trihydrate (ATH) pure polyster resin composite wash basin. Ventilation fan is provided. Copper pipes are used for cold water supply system and copper water pipes with thermal insulation for hot water supply.</p> <p>Master bathroom is fitted with Aluminum Trihydrate (ATH) pure polyster resin composite freestanding bath tub (1800mm L x 800mm W x 600mm H) with chrome plated bath mixer and shower.</p> <p>Bathroom 1 is fitted with enameled cast iron bath tub (1500mm L x 750mm W x 420mm H) with chrome plated bath mixer with shower bar.</p> <p>Shower cubicle fitted with chrome plated shower water mixer are provided in master bathroom and bathroom 2.</p> <p>For brand name and provisions of appliances, please refer to “Appliances Schedule”.</p>
(c) Kitchen	<p>Kitchen cabinet is completed with chipboard carcass, high gloss lacquered surface door frontal and high gloss high pressure laminated surface door panel, and equipped with artificial solid surface work top, stainless steel sink and chrome plated sink mixer. Copper pipes are used for cold water supply system and copper water pipes with thermal insulation for hot water supply.</p> <p>For brand name and provisions of appliances, please refer to “Appliances Schedule”.</p>
(d) Bedroom	Nil
(e) Telephone	<p>Telephone connection points are provided for living and dining room, master bedroom and bedroom.</p> <p>For location and number of connection points, please refer to the “Schedule of Mechanical & Electrical Provisions”.</p>
(f) Aerials	<p>TV outlets for local TV programmes are provided in living and dining room, kitchen, master bedroom, bedroom and master bathroom.</p> <p>For location and number of connection points, please refer to the “Schedule of Mechanical & Electrical Provisions”.</p>
(g) Electrical Installations	<p>Three-phase electricity supply with miniature circuit breakers distribution boards completed with residual-current device is provided. Conduit wiring concealed in walls or enclosed in false ceilings or bulkheads or cabinets for lightings and power points are provided.</p> <p>For location and number of socket points and air conditioner points, please refer to the “Schedule of Mechanical & Electrical Provisions”.</p>
(h) Gas Supply	<p>Town gas supply pipes are provided and connected to gas cooking hob and gas water heater. Gas meter connection point is located in the kitchen of each individual house.</p>
(i) Washing Machine Connection Point	<p>Drain point and water point are located in the kitchen.</p>
(j) Water Supply	<p>Copper water pipes are provided for cold water supply and copper water pipes with thermal insulation are provided for hot water supply.</p> <p>Hot water supply system is provided to kitchen and bathroom.</p> <p>Both hot and cold water pipes are partly concealed and partly exposed. ¹</p>

4. Miscellaneous	
Item	Description
(a) Lifts	Nil
(b) Letter Box	Metal letter box is provided for each individual house.
(c) Refuse Collection	A common refuse storage and material recovery chamber with vehicular access is provided at G/F for collection of refuse.
(d) Water Meter, Electricity Meter and Gas Meter	Separate water meter for each individual house is provided at water meter cabinet at B/F. Separate electricity meter for each individual house is provided at electricity meter cabinet at B/F. Space for separate gas meter is provided in the kitchen of each individual house.

5. Security Facilities	
Item	Description
Security System and Equipment	<p>CCTV cameras are installed at B/F car park, recreational facilities, emergency vehicular access at G/F and boundary fence walls are connected to the caretaker’s office.</p> <p>Visitor panel for access control is provided at G/F entrance of each individual house connecting to video door phone of each individual house.</p>

6. Appliances	
Item	Description
Appliances	For brand names and model numbers of appliances provided, please refer to the “Appliances Schedule”.

Notes:

- Other than those parts of the water pipes concealed with concrete, the rest of them are exposed. The exposed water pipes may be covered or hidden by false ceilings, bulkheads, cabinets, claddings, non-concrete partition walls, designated pipe ducts or other materials.

富豪·悅庭丹桂村路75A號

賣方承諾如項目中沒有安裝指明的品牌名稱或產品型號的升降機或設備，便會安裝品質相若的升降機或設備。

1. 外部裝修物料	
細項	描述
(a) 外牆	鋪砌天然石材板、玻璃幕牆、油漆、鋁板及衍石磚。
(b) 窗	客廳、飯廳、廚房、主人睡房及睡房採用氟炭噴塗鋁窗框連灰面玻璃。 主人浴室及浴室選用氟炭噴塗鋁窗框連半透光灰面玻璃。
(c) 窗台	沒有。
(d) 花槽	花槽外鋪砌瓷磚。
(e) 陽台或露台	牆身鋪砌天然石材板及鋁板，地台鋪砌均質瓷磚及天然石墜，露台外露天花鬆上乳膠漆。裝有玻璃欄杆。 為有蓋露台。 沒有陽台。
(f) 乾衣設施	沒有。

2. 室內裝修物料	
細項	描述
(a) 大堂	沒有。
(b) 內牆及天花板	內牆： 客廳、飯廳外露牆部分鋪砌瓷磚，鋪砌人造皮裝飾板連玻璃鏡面及鏡鋼，部分髹上高光漆，部分鋪砌瓷磚雲石。 主人睡房外露牆部分鋪砌人造皮裝飾板，部分鋪砌捫布、鏡及鏡鋼框夾紗玻璃。 睡房一外露牆部分鋪砌捫布板、人造皮裝飾板及鏡，部分髹上高光漆。 睡房二外露牆部分鋪砌捫布板、人造皮裝飾板及鏡，部分鋪砌牆紙。 天花板： 客廳、飯廳、主人睡房及睡房的天花板外露部分髹上乳膠漆，部分天花以石膏板鋪砌髹上乳膠漆。主人睡房部分天花鋪砌人造皮裝飾板。
(c) 內部地板	客廳、飯廳地台鋪砌瓷磚。主人睡房、睡房一及二地台鋪砌複合木地板，主人睡房及睡房一鋪砌鏡鋼腳線，睡房二鋪砌高光漆腳線。露台、花園或天台沿趟門之地台圍邊部分鋪砌天然石材。
(d) 浴室	主人浴室及浴室外露牆身鋪砌瓷磚及玻璃鏡面。外露地台鋪砌瓷磚。浴室裝設石膏板假天花髹上乳膠漆；主人浴室裝設不銹鋼框玻璃假天花。牆身飾面鋪砌至假天花高度。
(e) 廚房	外露牆身鋪砌瓷磚及玻璃鏡面。外露地台鋪砌瓷磚。裝設石膏板假天花髹上乳膠漆。灶台面為實心人造面板枱面。牆身飾面鋪砌至假天花高度。

3. 室內裝置	
細項	描述
(a) 門	地下防雨門： 氟炭噴塗鋁門框玻璃門，裝設門鎖。 地下單位大門： 單面木皮，單面高光漆實心木門。裝設門鎖、氣鼓、防盜眼及門阻。 地庫單位大門： 木皮面實心木門。裝設門鎖、氣鼓及門阻。 地庫樓梯旁木門： 木皮面實心木門。裝設氣鼓及門阻。 廚房： 焗漆鋁框防火玻璃門。裝設氣鼓及門阻。 主人睡房、睡房一： 高光漆空心木門。裝設門鎖及門阻。 睡房二： 單面高光漆、單面玻璃鏡面空心木門。裝設門鎖及門阻。 主人浴室： 鏡鋼框夾紗玻璃趟門。 浴室一： 玻璃鏡面空心木門。裝設門鎖及門阻。 浴室二： 鏡鋼框玻璃趟門。裝設門鎖。 客人洗手間： 單面高光漆，單面木皮空心木門。裝設門鎖及門阻。 儲物室 1： 單面牆紙裝飾，單面木皮空心木門。裝設氣鼓及門阻。 儲物室 1 旁廁所： 鋁門框玻璃摺門。 消防泵房： 膠板面實心木門。裝設門鎖、氣鼓及門阻。 消防喉轆門（地面層）： 高光漆面木門。 消防喉轆門（一樓）： 牆紙裝飾面木門。 消防喉轆門（二樓）： 瓷磚面鐵架門。 花園、露台及平台： 氟炭噴塗鋁框玻璃趟門，裝設門鎖。 天台門： 氟炭噴塗鋁門框玻璃門，裝設門鎖。

富豪·悅庭丹桂村路75A號

3. 室內裝置	
細項	描述
(b) 浴室	<p>主人浴室及浴室二選用木面鏡櫃。浴室一選用趟玻璃鏡面。主人浴室及浴室一、二選用雲石檯面。裝置及設備包括陶瓷坐廁、鍍鉻水龍頭、鍍鉻飾面毛巾架及廁紙架。主人浴室裝置陶瓷洗手盆，浴室一及二裝置鋁質鑄石洗手盆。設有抽氣扇。冷水喉採用銅喉管，熱水喉採用隔熱絕緣銅喉。</p> <p>主人浴室設有鋁質鑄石獨立式浴缸（1800 毫米長 x 800 毫米闊 x 600 毫米高），鍍鉻浴缸水龍頭連花灑水龍頭。</p> <p>浴室一設有瓷釉鑄鐵浴缸（1500 毫米長 x 750 毫米闊 x 420 毫米高），鍍鉻浴缸水龍頭連花灑水龍頭。</p> <p>主人浴室及浴室二淋浴間設有鍍鉻花灑水龍頭。</p> <p>隨樓附送之設備及品牌，請參閱“設備說明表”。</p>
(c) 廚房	<p>廚櫃由高級刨花板櫃體、高光烤漆櫃門和高光高壓耐高溫飾面板櫃門組成；並配有實心人造面板檯面、不銹鋼水槽和鍍鉻單控水龍頭。冷水喉採用銅喉管，熱水喉採用隔熱絕緣銅喉。</p> <p>隨樓附送之設備及品牌，請參閱“設備說明表”。</p>
(d) 睡房	沒有。
(e) 電話	<p>客飯廳、主人睡房及睡房一、二設有電話插座。</p> <p>有關接駁點的位置及數量，請參考“機電裝置數量說明表”。</p>
(f) 天線	<p>客飯廳、廚房、主人睡房及睡房均裝設有可接收本地電視節目的電視天線插座。</p> <p>有關接駁點的位置及數量，請參考“機電裝置數量說明表”。</p>
(g) 電力裝置	<p>提供三相電力配電箱並裝置有漏電斷路器。照明及電插座之導管暗藏於牆身或置於假天花、假陣或櫃內。</p> <p>有關電插座及空調機接駁點的位置及數量，請參考“機電裝置數量說明表”。</p>
(h) 氣體供應	煤氣喉接駁煤氣煮食爐及煤氣熱水爐。單位之煤氣錶接駁點位於廚房內。
(i) 洗衣機接駁點	洗衣機配備來水及去水接駁點設在廚房。
(j) 供水	<p>冷水喉採用銅喉及熱水喉採用配有隔熱絕緣保護之銅喉。</p> <p>廚房及浴室有熱水供應。</p> <p>冷熱水管是部分隱藏及部分外露。¹</p>

4. 雜項	
細項	描述
(a) 升降機	沒有。
(b) 信箱	每座洋房設置金屬信箱。
(c) 垃圾收集	一個設有車輛通道公用垃圾儲存及物料回收房位於地下提供垃圾收集處理。
(d) 水錶、電錶及氣體錶	<p>每座洋房之獨立水錶安裝於地庫水錶箱內。</p> <p>每座洋房之獨立電錶安裝於地庫電錶箱內。</p> <p>每座洋房之廚房內預留獨立煤氣錶位置。</p>

5. 保安設施	
細項	描述
保安系統及設備	<p>地庫停車場、康樂設施、地下緊急車輛通道及邊界圍牆均裝設有閉路電視，並連接管理員辦事處。</p> <p>每座洋房地下入口裝有訪客視像對講機並連接該洋房內之視像對講機。</p>

6. 設備	
細項	描述
設備	品牌名稱及產品型號：有關裝置和設備的品牌及產品型號，請參考“設備說明表”。

備註：

- 除部分隱藏於混凝土內之導管外，其他部分的導管均為外露。外露的導管可能被假天花、假陣、貯存櫃、覆面、非混凝土間牆、指定之槽位或其他物料遮蓋。

75B, 77A and 77B Tan Kwai Tsuen Road, Casa Regalia

The Vendor undertakes that if lifts or appliances of the specified brand name or model number are not installed in the Development, lifts or appliances of comparable quality will be installed.

1. Exterior Finishes	
Item	Description
(a) External Wall	Finished with natural stone cladding panels, curtain walls, paint, aluminum claddings and artificial granite tiles.
(b) Window	PVF2 aluminum window frames fitted with grey tinted glass for living room, dining room, kitchen, master bedroom and bedroom; PVF2 aluminum window frames fitted with obscured grey tinted glass for master bathroom and bathroom.
(c) Bay Window	Nil
(d) Planter	Externally finished with ceramic tiles.
(e) Verandah or balcony	Wall is finished with natural stone cladding and aluminum cladding. Floor is finished with homogenous tiles and natural stone tile curb. Exposed surfaces of ceilings of balcony are painted with emulsion paint. Fitted with glass balustrade. Balconies are covered. There is no verandah.
(f) Drying facilities for clothing	Nil

2. Interior Finishes	
Item	Description
(a) Lobby	Nil
(b) Internal wall and ceiling	Internal Walls: Exposed surfaces of internal walls of living room, dining room, master bedroom and bedroom are painted with emulsion paint. Ceilings: Exposed surfaces of ceilings of living room, dining room, master bedroom and bedroom are finished with emulsion paint. Some areas are equipped with gypsum board false ceilings with emulsion paint.
(c) Internal floor	Living room, dining room, master bedroom and bedroom are finished with engineering timber flooring and timber skirting with natural stone tiles adjoining sliding doors to balconies, gardens or flat roofs.
(d) Bathroom	Master bathroom and bathroom: Exposed surfaces of walls are finished with ceramic tiles and mirror. Exposed surfaces of floor are finished with ceramic tiles. Gypsum board false ceilings with emulsion paint are provided. Wall finishes run up to false ceiling.
(e) Kitchen	Exposed surfaces of walls are finished with mirror and ceramic tiles up to false ceiling level. Exposed surfaces of floors are finished with ceramic tiles. Gypsum board false ceiling painted with emulsion paint are provided. Cooking bench top is fitted with artificial solid surface work top. Wall finishes run up to false ceiling.

3. Interior Fittings	
Item	Description
(a) Doors	Rain Door at G/F Entrance : PVF2 aluminum framed glass door fitted with lockset. Main Entrance at G/F: Solid core timber door finished with timber veneer and fitted with lockset, door closer, eye viewer and door stopper. Entrance of House at B/F: Solid core timber door finished with timber veneer and fitted with lockset, door closer, door stopper. Door adjacent to staircase at B/F: Solid core timber door finished with timber veneer and fitted with door closer and door stopper. Kitchen: Solid core timber door finished with timber veneer and fitted with glass panel, door closer and door stopper. Master Bedroom, Bedroom, Master Bathroom, Bathroom (Except Bathroom 1), Guest Lavatory and Store Room 1: Hollow core timber door finished with timber veneer and fitted with lockset and door stopper. The doors of bathroom 2 and guest lavatory are fitted with louvers. Bathroom 1: Obscured sliding glass door. Store Room 2: Aluminum framed glass folding door. Store Room 1: Hollow core timber door finished with wallpaper at one side and timber veneer at another side. F.S. Pump Room: Solid core timber door finished with plastic laminate and fitted with lockset, door closer and door stopper Hose Reel Door: Timber door panel finished with timber veneer. Garden, Balcony and Flat Roof: Sliding glass door with PVF2 aluminum frame fitted with lockset. Roof Door: PVF2 aluminum framed glass door with lockset.
(b) Bathroom	Master Bathroom and bathroom are fitted with wooden mirror cabinet. All countertops are finished with artificial solid surface material. Fittings and equipment include vitreous china water closet, vitreous china wash basin, chrome plated towel bar and paper holder. Ventilation fan is provided. Copper pipes are used for cold water supply system and copper water pipes with thermal insulation for hot water supply. Master bathroom is fitted with enameled cast iron bath tub (1700mm L x 750mm W x 420mm H) with chrome plated bath mixer and shower bar. Bathrooms are fitted with enameled cast iron bath tub (1500mm L x 750mm W x 420mm H) with chrome plated bath mixer and shower bar. Shower cubicle fitted with chrome plated shower water mixer are provided in master bathroom. For brand name and provisions of appliances, please refer to "Appliances Schedule".
(c) Kitchen	Kitchen cabinet is completed with chipboard carcass, high gloss lacquered surface door frontal and high gloss high pressure laminated surface door panel, and equipped with artificial solid surface work top, stainless steel sink and chrome plated sink mixer. Copper pipes are used for cold water supply system and copper water pipes with thermal insulation for hot water supply. For brand name and provisions of appliances, please refer to "Appliances Schedule".
(d) Bedroom	Nil

75B, 77A and 77B Tan Kwai Tsuen Road, Casa Regalia

3. Interior Fittings	
Item	Description
(e) Telephone	Telephone connection points are provided for living room, dining room, master bedroom and bedroom. For location and number of connection points, please refer to the “Schedule of Mechanical & Electrical Provisions”.
(f) Aerials	TV/FM outlets for local TV/FM radio programmes are provided in living room, dining room, kitchen, master bedroom, bedroom and master bathroom. For location and number of connection points, please refer to the “Schedule of Mechanical & Electrical Provisions”.
(g) Electrical Installations	Three-phase electricity supply with miniature circuit breakers distribution boards completed with residual-current device is provided. Conduit wiring concealed in walls or enclosed in false ceilings or bulkheads or cabinets for lightings and power points are provided. For location and number of socket points and air conditioner points, please refer to the “Schedule of Mechanical & Electrical Provisions”.
(h) Gas Supply	Town gas supply pipes are provided and connected to gas cooking hob and gas water heater. Gas meter connection point is located in the kitchen of each individual house.
(i) Washing Machine Connection Point	Drain point and water point are located in the kitchen.
(j) Water Supply	Copper water pipes are provided for cold water supply and copper water pipes with thermal insulation are provided for hot water supply. Hot water supply system is provided to kitchen and bathroom. Both hot and cold water pipes are partly concealed and partly exposed. ¹

4. Miscellaneous	
Item	Description
(a) Lifts	Nil
(b) Letter Box	Metal letter box is provided for each individual house.
(c) Refuse Collection	A common refuse storage and material recovery chamber with vehicular access is provided at G/F for collection of refuse.
(d) Water Meter, Electricity Meter and Gas Meter	Separate water meter for each individual house is provided at water meter cabinet at B/F. Separate electricity meter for each individual house is provided at electricity meter cabinet at B/F. Space for separate gas meter is provided in the kitchen of each individual house.

5. Security Facilities	
Item	Description
Security System and Equipment	CCTV cameras are installed at B/F car park, recreational facilities, emergency vehicular access at G/F and boundary fence walls are connected to the caretaker’s office. Visitor panel for access control is provided at G/F entrance of each individual house connecting to video door phone of each individual house.

6. Appliances	
Item	Description
Appliances	For brand names and model numbers of appliances provided, please refer to the “Appliances Schedule”.

Notes:

- Other than those parts of the water pipes concealed with concrete, the rest of them are exposed. The exposed water pipes may be covered or hidden by false ceilings, bulkheads, cabinets, claddings, non-concrete partition walls, designated pipe ducts or other materials.

富豪·悅庭丹桂村路75B, 77A及77B號

賣方承諾如項目中沒有安裝指明的品牌名稱或產品型號的升降機或設備，便會安裝品質相若的升降機或設備。

1. 外部裝修物料	
細項	描述
(a) 外牆	鋪砌天然石材板、玻璃幕牆、油漆、鋁板及衍石磚。
(b) 窗	客廳、飯廳、廚房、主人睡房及睡房採用氟炭噴塗鋁窗框連灰面玻璃。 主人浴室及浴室選用氟炭噴塗鋁窗框連半透光灰面玻璃。
(c) 窗台	沒有。
(d) 花槽	花槽外鋪砌瓷磚。
(e) 陽台或露台	牆身鋪砌天然石材板及鋁板，地台鋪砌均質瓷磚及天然石墜，露台外露天花鬆上乳膠漆。裝有玻璃欄杆。 為有蓋露台。 沒有陽台。
(f) 乾衣設施	沒有。

2. 室內裝修物料	
細項	描述
(a) 大堂	沒有。
(b) 內牆及天花板	內牆： 客廳、飯廳、主人睡房及睡房內外露牆髹乳膠漆。 天花板： 客廳、飯廳、主人睡房及睡房的天花板外露部份髹上乳膠漆，部分天花以石膏板鋪砌髹上乳膠漆。
(c) 內部地板	客廳、飯廳、主人睡房及睡房內部地板鋪砌複合木地板及木腳線。露台、花園或天台沿趟門之地台圍邊部分鋪砌天然石材。
(d) 浴室	主人浴室及浴室外露牆身鋪砌瓷磚及玻璃鏡面。外露地台鋪砌瓷磚。裝設石膏板假天花髹上乳膠漆。牆身飾面鋪砌至假天花高度。
(e) 廚房	外露牆身鋪砌瓷磚及玻璃鏡面。外露地台鋪砌瓷磚。裝設石膏板假天花髹上乳膠漆。灶台面為實心人造面板枱面。牆身飾面鋪砌至假天花高度。

3. 室內裝置	
細項	描述
(a) 門	地下防雨門： 氟炭噴塗鋁門框玻璃門，裝設門鎖。 地下單位大門： 木皮面實心木門。裝設門鎖、氣鼓、防盜眼及門阻。 地庫單位大門： 木皮面實心木門。裝設門鎖、氣鼓及門阻。 地庫樓梯旁木門： 木皮面實心木門。裝設氣鼓及門阻。 廚房： 木皮面實心木門配以玻璃。裝設氣鼓及門阻。 主人睡房、睡房、主人浴室、浴室（除浴室1外）、客人洗手間及儲物室1： 木皮面空心木門。裝設門鎖及門阻。浴室2及客人洗手間門設有百葉。 浴室一： 半透光玻璃趟門。 儲物室2： 鋁門框玻璃摺門。 消防泵房： 膠板面實心木門。裝設門鎖、氣鼓及門阻。 消防喉轆門： 木皮面木門。 花園、露台及平台： 氟炭噴塗鋁框玻璃趟門，裝設門鎖。 天台門： 氟炭噴塗鋁門框玻璃門，裝設門鎖。
(b) 浴室	主人浴室及浴室選用木面鏡櫃。主人浴室及浴室選用實心人造面板檯面。裝置及設備包括陶瓷坐廁、陶瓷洗手盆、鍍鉻飾面毛巾架及廁紙架。設有抽氣扇。冷水喉採用銅喉管，熱水喉採用隔熱絕緣銅喉。主人浴室設有瓷釉鑄鐵浴缸（1700 毫米長 x 750 毫米闊 x 420 毫米高），鍍鉻浴缸水龍頭及花灑水龍頭。 浴室設有瓷釉鑄鐵浴缸（1500 毫米長 x 750 毫米闊 x 420 毫米高），鍍鉻浴缸水龍頭及花灑水龍頭。 主人浴室淋浴間設有鍍鉻花灑水龍頭。 隨樓附送之設備及品牌，請參閱“設備說明表”。
(c) 廚房	廚櫃由高級刨花板櫃體、高光烤漆櫃門和高光高壓耐高溫飾面板櫃門組成；並配有實心人造面板檯面、不銹鋼水槽和鍍鉻單控水龍頭。冷水喉採用銅喉管，熱水喉採用隔熱絕緣銅喉。 隨樓附送之設備及品牌，請參閱“設備說明表”。
(d) 睡房	沒有。

富豪·悅庭丹桂村路75B, 77A及77B號

3. 室內裝置	
細項	描述
(e) 電話	客廳、飯廳、主人睡房及睡房設有電話插座。 有關接駁點的位置及數量，請參考“機電裝置數量說明表”。
(f) 天線	客廳、飯廳、廚房、主人睡房及睡房均裝設有可接收本地電視節目及電台節目的電視 / 收音機天線插座。 有關接駁點的位置及數量，請參考“機電裝置數量說明表”。
(g) 電力裝置	提供三相電力配電箱並裝置有漏電斷路器。照明及電插座之導管暗藏於牆身或置於假天花、假陣或櫃內。 有關電插座及空調機接駁點的位置及數量，請參考“機電裝置數量說明表”。
(h) 氣體供應	煤氣喉接駁煤氣煮食爐及煤氣熱水爐。單位之煤氣錶接駁點位於廚房內。
(i) 洗衣機接駁點	洗衣機配備來水及去水接駁點設在廚房。
(j) 供水	冷水喉採用銅喉及熱水喉採用配有隔熱絕緣保護之銅喉。 廚房及浴室有熱水供應。 冷熱水管是部分隱藏及部分外露。 ¹

4. 雜項	
細項	描述
(a) 升降機	沒有。
(b) 信箱	每座洋房設置金屬信箱。
(c) 垃圾收集	一個設有車輛通道公用垃圾儲存及物料回收房位於地下提供垃圾收集處理。
(d) 水錶、電錶及氣體錶	每座洋房之獨立水錶安裝於地庫水錶箱內。 每座洋房之獨立電錶安裝於地庫電錶箱內。 每座洋房之廚房內預留獨立煤氣錶位置。

5. 保安設施	
細項	描述
保安系統及設備	地庫停車場、康樂設施、地下緊急車輛通道及邊界圍牆均裝設有閉路電視，並連接管理員辦事處。 每座洋房地下入口裝有訪客視像對講機並連接該洋房內之視像對講機。

6. 設備	
細項	描述
設備	品牌名稱及產品型號：有關裝置和設備的品牌及產品型號，請參考“設備說明表”。

備註：

- 除部分隱藏於混凝土內之導管外，其他部分的導管均為外露。外露的導管可能被假天花、假陣、貯存櫃、覆面、非混凝土間牆、指定之槽位或其他物料遮蓋。

79A, 79B, 79C, 79D, 79E and 79F Tan Kwai Tsuen Road, Casa Regalia

The Vendor undertakes that if lifts or appliances of the specified brand name or model number are not installed in the Development, lifts or appliances of comparable quality will be installed.

1. Exterior Finishes	
Item	Description
(a) External Wall	Finished with natural stone cladding panels, curtain walls, paint, aluminum claddings and artificial granite tiles.
(b) Window	PVF2 aluminum window frames fitted with grey tinted glass for living room, dining room, kitchen, master bedroom and bedroom; PVF2 aluminum window frames fitted with obscured grey tinted glass for master bathroom and bathroom.
(c) Bay Window	Nil
(d) Planter	Externally finished with ceramic tiles.
(e) Verandah or balcony	Wall is finished with natural stone cladding and aluminum cladding. Floor is finished with homogenous tiles and natural stone tile curb. Exposed surfaces of ceilings of balcony are painted with emulsion paint. Fitted with glass balustrade. Balconies are covered. There is no verandah.
(f) Drying facilities for clothing	Nil

2. Interior Finishes	
Item	Description
(a) Lobby	Nil
(b) Internal wall and ceiling	Internal Walls: Exposed surfaces of internal walls of living room, dining room, master bedroom and bedroom are painted with emulsion paint. Ceilings: Exposed surfaces of ceilings of living room, dining room, master bedroom and bedroom are finished with emulsion paint. Some areas are equipped with gypsum board false ceilings with emulsion paint.
(c) Internal floor	Living room, dining room, master bedroom and bedroom are finished with engineering timber flooring and timber skirting with natural stone tiles adjoining sliding doors to balconies, gardens or flat roofs.
(d) Bathroom	Master bathroom and bathroom: Exposed surfaces of walls are finished with ceramic tiles and mirror. Exposed surfaces of floor are finished with ceramic tiles. Gypsum board false ceilings with emulsion paint are provided. Wall finishes run up to false ceiling.
(e) Kitchen	Exposed surfaces of walls are finished with mirror and ceramic tiles up to false ceiling level. Exposed surfaces of floors are finished with ceramic tiles. Gypsum board false ceiling painted with emulsion paint are provided. Cooking bench top is fitted with artificial solid surface work top. Wall finishes run up to false ceiling.

3. Interior Fittings	
Item	Description
(a) Doors	Rain Door at G/F Entrance : PVF2 aluminum framed glass door fitted with lockset. Main Entrance at G/F: Solid core timber door finished with timber veneer and fitted with lockset, door closer, eye viewer and door stopper. Entrance of House at B/F: Solid core timber door finished with timber veneer and fitted with lockset, door closer, door stopper. Door adjacent to staircase at B/F: Solid core timber door finished with timber veneer and fitted with door closer and door stopper. Kitchen: Solid core timber door finished with timber veneer and fitted with glass panel, door closer and door stopper. Master Bedroom, Bedroom, Master Bathroom, Bathroom (Except Bathroom 1), Guest Lavatory and Store Room 1: Hollow core timber door finished with timber veneer and fitted with lockset and door stopper. The doors of bathroom 2 and guest lavatory are fitted with louvers. Bathroom 1: Obscured sliding glass door Store Room 2: Aluminum framed glass folding door. F.S. Pump Room: Solid core timber door finished with plastic laminate and fitted with lockset, door closer and door stopper. Hose Reel Door: Timber door panel finished with timber veneer. Garden, Balcony and Flat Roof: Sliding glass door with PVF2 aluminum frame fitted with lockset. Roof Door: PVF2 aluminum framed glass door with lockset.
(b) Bathroom	Master Bathroom and bathroom are fitted with wooden mirror cabinet. All countertops are finished with artificial solid surface material. Fittings and equipment include vitreous china water closet, vitreous china wash basin, chrome plated towel bar and paper holder. Ventilation fan is provided. Copper pipes are used for cold water supply system and copper water pipes with thermal insulation for hot water supply. Master bathroom is fitted with enameled cast iron bath tub (1700mm L x 750mm W x 420mm H) with chrome plated bath mixer and shower bar. Bathrooms are fitted with enameled cast iron bath tub (1500mm L x 750mm W x 420mm H) with chrome plated bath mixer and shower bar. Shower cubicle fitted with chrome plated shower water mixer are provided in master bathroom. For brand name and provisions of appliances, please refer to "Appliances Schedule".

79A, 79B, 79C, 79D, 79E and 79F Tan Kwai Tsuen Road, Casa Regalia

3. Interior Fittings	
Item	Description
(c) Kitchen	Kitchen cabinet is completed with chipboard carcass, high gloss lacquered surface door frontal and high gloss high pressure laminated surface door panel, and equipped with artificial solid surface work top, stainless steel sink and chrome plated sink mixer. Copper pipes are used for cold water supply system and copper water pipes with thermal insulation for hot water supply. For brand name and provisions of appliances, please refer to “Appliances Schedule”.
(d) Bedroom	Nil
(e) Telephone	Telephone connection points are provided for living room, dining room, master bedroom and bedroom. For location and number of connection points, please refer to the “Schedule of Mechanical & Electrical Provisions”.
(f) Aerials	TV/FM outlets for local TV/FM radio programmes are provided in living room, dining room, kitchen, master bedroom, bedroom and master bathroom. For location and number of connection points, please refer to the “Schedule of Mechanical & Electrical Provisions”.
(g) Electrical Installations	Three-phase electricity supply with miniature circuit breakers distribution boards completed with residual-current device is provided. Conduit wiring concealed in walls or enclosed in false ceilings or bulkheads or cabinets for lightings and power points are provided. For location and number of socket points and air conditioner points, please refer to the “Schedule of Mechanical & Electrical Provisions”.
(h) Gas Supply	Town gas supply pipes are provided and connected to gas cooking hob and gas water heater. Gas meter connection point is located in the kitchen of each individual house.
(i) Washing Machine Connection Point	Drain point and water point are located in the kitchen.
(j) Water Supply	Copper water pipes are provided for cold water supply and copper water pipes with thermal insulation are provided for hot water supply. Hot water supply system is provided to kitchen and bathroom. Both hot and cold water pipes are partly concealed and partly exposed. ¹

4. Miscellaneous	
Item	Description
(a) Lifts	Nil
(b) Letter Box	Metal letter box is provided for each individual house.
(c) Refuse Collection	A common refuse storage and material recovery chamber with vehicular access is provided at G/F for collection of refuse.
(d) Water Meter, Electricity Meter and Gas Meter	Separate water meter for each individual house is provided at water meter cabinet at B/F. Separate electricity meter for each individual house is provided at electricity meter cabinet at B/F. Space for separate gas meter is provided in the kitchen of each individual house.

5. Security Facilities	
Item	Description
Security System and Equipment	CCTV cameras are installed at B/F car park, recreational facilities, emergency vehicular access at G/F and boundary fence walls are connected to the caretaker’s office. Visitor panel for access control is provided at G/F entrance of each individual house connecting to video door phone of each individual house.

6. Appliances	
Item	Description
Appliances	For brand names and model numbers of appliances provided, please refer to the “Appliances Schedule”.

Notes:

- Other than those parts of the water pipes concealed with concrete, the rest of them are exposed. The exposed water pipes may be covered or hidden by false ceilings, bulkheads, cabinets, claddings, non-concrete partition walls, designated pipe ducts or other materials.

富豪·悅庭丹桂村路79A、79B、79C、79D、79E、79F號

賣方承諾如項目中沒有安裝指明的品牌名稱或產品型號的升降機或設備，便會安裝品質相若的升降機或設備。

1. 外部裝修物料	
細項	描述
(a) 外牆	鋪砌天然石材板、玻璃幕牆、油漆、鋁板及仿石磚。
(b) 窗	客廳、飯廳、廚房、主人睡房及睡房採用氟炭噴塗鋁窗框連灰面玻璃。 主人浴室及浴室選用氟炭噴塗鋁窗框連半透光灰面玻璃。
(c) 窗台	沒有。
(d) 花槽	花槽外鋪砌瓷磚。
(e) 陽台或露台	牆身鋪砌天然石材板及鋁板，地台鋪砌均質瓷磚及天然石墜，露台外露天花髹上乳膠漆。裝有玻璃欄杆。 為有蓋露台。 沒有陽台。
(f) 乾衣設施	沒有。

2. 室內裝修物料	
細項	描述
(a) 大堂	沒有。
(b) 內牆及天花板	內牆： 客廳、飯廳、主人睡房及睡房內外露牆髹乳膠漆。 天花板： 客廳、飯廳、主人睡房及睡房的天花板外露部份髹上乳膠漆，部分天花以石膏板鋪砌髹上乳膠漆。
(c) 內部地板	客廳、飯廳、主人睡房及睡房內部地板鋪砌複合木地板及木腳線。露台、花園或天台沿趟門之地台圍邊部分鋪砌天然石材。
(d) 浴室	主人浴室及浴室外露牆身鋪砌瓷磚及玻璃鏡面。外露地台鋪砌瓷磚。裝設石膏板假天花髹上乳膠漆。牆身飾面鋪砌至假天花高度。
(e) 廚房	外露牆身鋪砌瓷磚及玻璃鏡面。外露地台鋪砌瓷磚。裝設石膏板假天花髹上乳膠漆。灶台面為實心人造面板枱面。牆身飾面鋪砌至假天花高度。

3. 室內裝置	
細項	描述
(a) 門	地下防雨門： 氟炭噴塗鋁門框玻璃門，裝設門鎖。 地下單位大門： 木皮面實心木門。裝設門鎖、氣鼓、防盜眼及門阻。 地庫單位大門： 木皮面實心木門。裝設門鎖、氣鼓及門阻。 地庫樓梯旁木門： 木皮面實心木門。裝設氣鼓及門阻。 廚房： 木皮面實心木門配以玻璃。裝設氣鼓及門阻。 主人睡房、睡房、主人浴室、浴室（除浴室1外）、客人洗手間及儲物室1： 木皮面空心木門。裝設門鎖及門阻。浴室2及客人洗手間門設有百葉。 浴室1： 半透光玻璃趟門。 儲物室2： 鋁門框玻璃摺門。 消防泵房： 膠板面實心木門。裝設門鎖、氣鼓及門阻。 消防喉轆門： 木皮面木門。 花園、露台及平台： 氟炭噴塗鋁框玻璃趟門，裝設門鎖。 天台門： 氟炭噴塗鋁門框玻璃門，裝設門鎖。
(b) 浴室	主人浴室及浴室選用木面鏡櫃。主人浴室及浴室選用實心人造面板檯面。裝置及設備包括陶瓷坐廁、陶瓷洗手盆、鍍鉻飾面毛巾架及廁紙架。設有抽氣扇。冷水喉採用銅喉管，熱水喉採用隔熱絕緣銅喉。 主人浴室設有瓷釉鑄鐵浴缸（1700毫米長 x 750毫米闊 x 420毫米高），鍍鉻浴缸水龍頭及花灑水龍頭。 浴室設有瓷釉鑄鐵浴缸（1500毫米長 x 750毫米闊 x 420毫米高），鍍鉻浴缸水龍頭及花灑水龍頭。 主人浴室淋浴間設有鍍鉻花灑水龍頭。 隨樓附送之設備及品牌，請參閱“設備說明表”。
(c) 廚房	廚櫃由高級刨花板櫃體、高光烤漆櫃門和高光高壓耐高溫飾面板櫃門組成；並配有實心人造面板檯面、不銹鋼水槽和鍍鉻單控水龍頭。冷水喉採用銅喉管，熱水喉採用隔熱絕緣銅喉。 隨樓附送之設備及品牌，請參閱“設備說明表”。
(d) 睡房	沒有。

富豪·悅庭丹桂村路79A、79B、79C、79D、79E、79F號

3. 室內裝置	
細項	描述
(e) 電話	客廳、飯廳、主人睡房及睡房設有電話插座。 有關接駁點的位置及數量，請參考“機電裝置數量說明表”。
(f) 天線	客廳、飯廳、廚房、主人睡房、睡房及主人浴室均裝設有可接收本地電視節目及電台節目的電視 / 收音機天線插座。 有關接駁點的位置及數量，請參考“機電裝置數量說明表”。
(g) 電力裝置	提供三相電力配電箱並裝置有漏電斷路器。照明及電插座之導管暗藏於牆身或置於假天花、假陣或櫃內。 有關電插座及空調機接駁點的位置及數量，請參考“機電裝置數量說明表”。
(h) 氣體供應	煤氣喉接駁煤氣煮食爐及煤氣熱水爐。單位之煤氣錶接駁點位於廚房。
(i) 洗衣機接駁點	洗衣機配備來水及去水接駁點設在廚房。
(j) 供水	冷水喉採用銅喉及熱水喉採用配有隔熱絕緣保護之銅喉。 廚房及浴室有熱水供應。 冷熱水管是部分隱藏及部分外露。 ¹

4. 雜項	
細項	描述
(a) 升降機	沒有。
(b) 信箱	每座洋房設置金屬信箱。
(c) 垃圾收集	一個設有車輛通道公用垃圾儲存及物料回收房位於地下提供垃圾收集處理。
(d) 水錶、電錶及氣體錶	每座洋房之獨立水錶安裝於地庫水錶箱內。 每座洋房之獨立電錶安裝於地庫電錶箱內。 每座洋房之廚房內預留獨立煤氣錶位置。

5. 保安設施	
細項	描述
保安系統及設備	地庫停車場、康樂設施、地下緊急車輛通道及邊界圍牆均裝設有閉路電視，並連接管理員辦事處。 每座洋房地下入口裝有訪客視像對講機並連接該洋房內之視像對講機。

6. 設備	
細項	描述
設備	品牌名稱及產品型號：有關裝置和設備的品牌及產品型號，請參考“設備說明表”。

備註：

- 除部分隱藏於混凝土內之導管外，其他部分的導管均為外露。外露的導管可能被假天花、假陣、貯存櫃、覆面、非混凝土間牆、指定之槽位或其他物料遮蓋。

81 Tan Kwai Tsuen Road, Casa Regalia

The Vendor undertakes that if lifts or appliances of the specified brand name or model number are not installed in the Development, lifts or appliances of comparable quality will be installed.

1. Exterior Finishes	
Item	Description
(a) External Wall	Finished with natural stone cladding panels, curtain walls, paint, aluminum claddings and artificial granite tiles.
(b) Window	PVF2 aluminum window frames fitted with grey tinted glass for living room, dining room, kitchen, master bedroom and bedroom; PVF2 aluminum window frames fitted with obscured grey tinted glass for master bathroom and bathroom.
(c) Bay Window	Nil
(d) Planter	Externally finished with ceramic tiles.
(e) Verandah or balcony	Wall is finished with natural stone cladding and aluminum cladding. Floor is finished with homogenous tiles and natural stone tile curb. Exposed surfaces of ceilings of balcony are plastered and painted with emulsion paint. Fitted with glass balustrade. Balconies are covered. There is no verandah.
(f) Drying facilities for clothing	Nil

2. Interior Finishes	
Item	Description
(a) Lobby	Internal walls are finished with plaster up to the ceiling. Floors are finished with floor screeding. Ceilings are finished with concrete finish.
(b) Internal wall and ceiling	Internal Walls: Internal walls of living room, dining room, master bedroom and bedroom are finished with plaster up to the ceiling. Ceilings: Ceilings of living room, dining room, master bedroom and bedroom are finished with plaster.
(c) Internal floor	Living room, dining room, master bedroom and bedroom are finished with floor screeding. No skirting.
(d) Bathroom	Master bathroom and bathroom: Walls are finished with plaster up to ceiling level. Ceiling are finished with concrete finish. Floors are finished with floor screeding. No skirting.
(e) Kitchen	Exposed surfaces of walls are finished with mirror and ceramic tiles up to false ceiling level. Exposed surfaces of floors are finished with ceramic tiles. Gypsum board false ceiling painted with emulsion paint are provided. Cooking bench top is fitted with artificial solid surface work top.

3. Interior Fittings	
Item	Description
(a) Doors	<p>Rain Door at G/F Entrance : PVF2 aluminum framed glass door fitted with lockset.</p> <p>Main Entrance at G/F: Solid core timber door finished with timber veneer and fitted with lockset, door closer, door stopper and eye viewer.</p> <p>Entrance of House at B/F: Solid core timber door finished with timber veneer and fitted with lockset, door closer, door stopper.</p> <p>Door adjacent to staircase at B/F: Solid core timber door finished with timber veneer and fitted with door closer and door stopper.</p> <p>Kitchen: Solid core timber door finished with timber veneer and fitted with glass panel, door closer and door stopper.</p> <p>Master Bedroom , Bedroom, Master Bathroom, Guest Lavatory, Store Room 1 and 2: Hollow core timber door finished with timber veneer and fitted with lockset and door stopper.</p> <p>Lavatory adjacent Store Room 1: Aluminum framed glass folding door.</p> <p>F.S. Pump Room: Solid core timber door finished with plastic laminate and fitted with lockset, door closer and door stopper.</p> <p>Hose Reel Door: Timber door panel.</p> <p>Garden, Balcony and Flat Roof: Sliding glass door with PVF2 aluminum frame fitted with lockset.</p> <p>Roof Door: PVF2 aluminum framed glass door with lockset.</p>
(b) Bathroom	<p>Master bathroom and bathroom are fitted with vitreous china wash basin, chrome plated water mixer and vitreous china water closet. Ventilation fan is provided.</p> <p>Copper pipes are used for cold water supply system and copper water pipes with thermal insulation for hot water supply.</p> <p>For brand name and provisions of appliances, please refer to "Appliances Schedule".</p>

81 Tan Kwai Tsuen Road, Casa Regalia

3. Interior Fittings	
Item	Description
(c) Kitchen	Kitchen cabinet is completed with chipboard carcass, high gloss lacquered surface door frontal and high gloss high pressure laminated surface door panel, and equipped with artificial solid surface work top, stainless steel sink and chrome plated sink mixer. Copper pipes are used for cold water supply system and copper water pipes with thermal insulation for hot water supply. For brand name and provisions of appliances, please refer to “Appliances Schedule”.
(d) Bedroom	Nil
(e) Telephone	Telephone connection points are provided for living room, dining room, master bedroom, bedroom and study room. For location and number of connection points, please refer to the “Schedule of Mechanical & Electrical Provisions”.
(f) Aerials	TV/FM outlets for local TV/FM radio programmes are provided in living room, dining room, kitchen, master bedroom, bedroom, master bathroom and study room. For location and number of connection points, please refer to the “Schedule of Mechanical & Electrical Provisions”.
(g) Electrical Installations	Three-phase electricity supply with miniature circuit breakers distribution boards completed with residual-current device is provided. Conduit wiring concealed in walls or enclosed in false ceilings or bulkheads or cabinets for lightings and power points are provided. For location and number of socket points and air conditioner points, please refer to the “Schedule of Mechanical & Electrical Provisions”.
(h) Gas Supply	Town gas supply pipes are provided and connected to gas cooking hob and gas water heater. Gas meter connection point is located in the kitchen of the house.
(i) Washing Machine Connection Point	Drain point and water point are located in the kitchen.
(j) Water Supply	Copper water pipes are provided for cold water supply and copper water pipes with thermal insulation are provided for hot water supply. Hot water supply system is provided to kitchen and bathroom. Both hot and cold water pipes are partly concealed and partly exposed. ¹

4. Miscellaneous	
Item	Description
(a) Lifts	1 no. of “Fujitect” lift (model no. ML-GSh) serving the B/F, G/F, 1/F and 2/F.
(b) Letter Box	Metal letter box is provided for the house.
(c) Refuse Collection	A common refuse storage and material recovery chamber with vehicular access is provided at G/F for collection of refuse.
(d) Water Meter, Electricity Meter and Gas Meter	Water meter is provided at water meter cabinet at B/F. Separate electricity meter is provided at electricity meter cabinet at B/F. Space for separate gas meter is provided in the kitchen.

5. Security Facilities	
Item	Description
Security System and Equipment	CCTV cameras are installed at B/F car park, recreational facilities, emergency vehicular access at G/F and boundary fence walls are connected to the caretaker’s office. Visitor panel for access control is provided at G/F entrance of the house connecting to video door phone of the house.

6. Appliances	
Item	Description
Appliances	For brand names and model numbers of appliances provided, please refer to the “Appliances Schedule”.

Notes:

- Other than those parts of the water pipes concealed with concrete, the rest of them are exposed. The exposed water pipes may be covered or hidden by false ceilings, bulkheads, cabinets, claddings, non-concrete partition walls, designated pipe ducts or other materials.

富豪·悅庭丹桂村路81號

賣方承諾如項目中沒有安裝指明的品牌名稱或產品型號的升降機或設備，便會安裝品質相若的升降機或設備。

1. 外部裝修物料	
細項	描述
(a) 外牆	鋪砌天然石材板、玻璃幕牆、油漆、鋁板及衍石磚。
(b) 窗	客廳、飯廳、主人睡房、睡房及廚房採用氟炭噴塗鋁窗框連灰面玻璃。主人浴室及浴室選用氟炭噴塗鋁窗框連半透光灰面玻璃。
(c) 窗台	沒有。
(d) 花槽	花槽外鋪砌瓷磚。
(e) 陽台或露台	牆身鋪砌天然石材板及鋁板，地台鋪砌均質瓷磚及天然石壘，露台外露天花髹上乳膠漆。裝有玻璃欄杆。 為有蓋露台。 沒有陽台。
(f) 乾衣設施	沒有。

2. 室內裝修物料	
細項	描述
(a) 大堂	內牆為批盪面至天花，地板為批盪面，天花為混凝土面。
(b) 內牆及天花板	內牆： 客廳、飯廳、主人睡房及睡房內為批盪面至天花。 天花板： 客廳、飯廳、主人睡房及睡房的天花板為批盪面。
(c) 內部地板	客廳、飯廳、主人睡房及睡房內部地板為批盪面。沒有腳線。
(d) 浴室	主人浴室及浴室牆身為批盪面至天花。天花為混凝土面。地台為批盪面。沒有腳線。
(e) 廚房	外露牆身鋪砌瓷磚及玻璃鏡面。外露地台鋪砌瓷磚。裝設石膏板假天花髹上乳膠漆。灶台面為實心人造面板枱面。牆身飾面鋪砌至假天花高度。

3. 室內裝置	
細項	描述
(a) 門	地下防雨門： 氟炭噴塗鋁門框玻璃門，裝設門鎖。 地下單位大門： 木皮面實心木門。裝設門鎖、氣鼓、防盜眼及門阻。 地庫單位大門： 木皮面實心木門。裝設門鎖、氣鼓及門阻。 地庫樓梯旁木門： 木皮面實心木門。裝設氣鼓及門阻。 廚房： 木皮面實心木門配以玻璃。裝設氣鼓及門阻。 主人睡房、睡房、主人浴室、浴室、儲物室 1 及 2： 木皮面空心木門。裝設門鎖及門阻。 儲物室旁廁所： 鋁門框玻璃摺門。 消防泵房： 膠板面實心木門。裝設門鎖、氣鼓及門阻。 消防喉轆門： 木門板。 花園、露台及平台： 氟炭噴塗鋁框玻璃趟門，裝設門鎖。 天台門： 氟炭噴塗鋁門框玻璃門，裝設門鎖。
(b) 浴室	主人浴室及浴室裝置及設備包括陶瓷坐廁、陶瓷洗手盆及鍍鉻水龍頭。設有抽氣扇。冷水喉採用銅喉管，熱水喉採用隔熱絕緣銅喉。隨樓附送之設備及品牌，請參閱“設備說明表”。
(c) 廚房	廚櫃由高級刨花板櫃體、高光烤漆櫃門和高光高壓耐高溫飾面板櫃門組成；並配有實心人造面板檯面、不銹鋼水槽和鍍鉻單控水龍頭。冷水喉採用銅喉管，熱水喉採用隔熱絕緣銅喉。隨樓附送之設備及品牌，請參閱“設備說明表”。
(d) 睡房	沒有。
(e) 電話	客廳、飯廳、主人睡房、睡房及閱讀室設有電話插座。有關接駁點的位置及數量，請參考“機電裝置數量說明表”。

富豪·悅庭丹桂村路81號

3. 室內裝置	
細項	描述
(f) 天線	客廳、飯廳、廚房、主人睡房、睡房、主人浴室及閱讀室均裝設有可接收本地電視節目及電台節目的電視 / 收音機天線插座。 有關接駁點的位置及數量，請參考“機電裝置數量說明表”。
(g) 電力裝置	提供三相電力配電箱並裝置有漏電斷路器。照明及電插座之導管暗藏於牆身或置於假天花、假陣或櫃內。 有關電插座及空調機接駁點的位置及數量，請參考“機電裝置數量說明表”。
(h) 氣體供應	煤氣喉接駁煤氣煮食爐及煤氣熱水爐。單位之煤氣錶接駁點位於廚房內。
(i) 洗衣機接駁點	洗衣機配備來水及去水接駁點設在廚房。
(j) 供水	冷水喉採用銅喉及熱水喉採用配有隔熱絕緣保護之銅喉。 廚房及浴室有熱水供應。 冷熱水管是部分隱藏及部分外露。 ¹

4. 雜項	
細項	描述
(a) 升降機	1 部“富士達”升降機（型號：ML-GSh）直達地庫、地下、一樓及二樓。
(b) 信箱	設置金屬信箱。
(c) 垃圾收集	一個設有車輛通道公用垃圾儲存及物料回收房位於地下提供垃圾收集處理。
(d) 水錶、電錶及氣體錶	獨立水錶安裝於地庫水錶箱內。 獨立電錶安裝於地庫電錶箱內。 廚房內預留獨立煤氣錶位置。

5. 保安設施	
細項	描述
保安系統及設備	地庫停車場、康樂設施、地下緊急車輛通道及邊界圍牆均裝設有閉路電視，並連接管理員辦事處。 洋房地下入口裝有訪客視像對講機並連接洋房內之視像對講機。

6. 設備	
細項	描述
設備	品牌名稱及產品型號：有關裝置和設備的品牌及產品型號，請參考“設備說明表”。

備註：

- 除部分隱藏於混凝土內之導管外，其他部分的導管均為外露。外露的導管可能被假天花、假陣、貯存櫃、覆面、非混凝土間牆、指定之槽位或其他物料遮蓋。

83A, 83C, 83D, 83E, 83F and 83G Tan Kwai Tsuen Road, Casa Regalia

The Vendor undertakes that if lifts or appliances of the specified brand name or model number are not installed in the Development, lifts or appliances of comparable quality will be installed.

1. Exterior Finishes	
Item	Description
(a) External Wall	Finished with natural stone cladding panels, curtain walls, paint, aluminum claddings and artificial granite tiles.
(b) Window	PVF2 aluminum window frames fitted with grey tinted glass for living room, dining room, kitchen, master bedroom and bedroom; PVF2 aluminum window frames fitted with obscured grey tinted glass for master bathroom and bathroom.
(c) Bay Window	Nil
(d) Planter	Externally finished with ceramic tiles.
(e) Verandah or balcony	Wall is finished with natural stone cladding and aluminum cladding. Floor is finished with homogenous tiles and natural stone tile curb. Exposed surfaces of ceilings of balcony are painted with emulsion paint. Fitted with glass balustrade. Balconies are covered. There is no verandah.
(f) Drying facilities for clothing	Nil

2. Interior Finishes	
Item	Description
(a) Lobby	Nil
(b) Internal wall and ceiling	Internal Walls: Exposed surfaces of internal walls of living room, dining room, master bedroom and bedroom are painted with emulsion paint. Ceilings: Exposed surfaces of ceilings of living room, dining room, master bedroom and bedroom are finished with emulsion paint. Some areas are equipped with gypsum board false ceilings with emulsion paint.
(c) Internal floor	Living room, dining room, master bedroom and bedroom are finished with engineering timber flooring and timber skirting with natural stone tiles adjoining sliding doors to balconies, gardens or flat roofs.
(d) Bathroom	Master bathroom and bathroom: Exposed surfaces of walls are finished with ceramic tiles and mirror. Exposed surfaces of floor are finished with ceramic tiles. Gypsum board false ceilings with emulsion paint are provided. Wall finishes run up to false ceiling.
(e) Kitchen	Exposed surfaces of walls are finished with mirror and ceramic tiles up to false ceiling level. Exposed surfaces of floors are finished with ceramic tiles. Gypsum board false ceiling painted with emulsion paint are provided. Cooking bench top is fitted with artificial solid surface work top. Wall finishes run up to false ceiling.

3. Interior Fittings	
Item	Description
(a) Doors	Rain Door at G/F Entrance : PVF2 aluminum framed glass door fitted with lockset. Main Entrance at G/F: Solid core timber door finished with timber veneer and fitted with lockset, door closer, eye viewer and door stopper. Entrance of House at B/F: Solid core timber door finished with timber veneer and fitted with lockset, door closer, door stopper. Door adjacent to staircase at B/F: Solid core timber door finished with timber veneer and fitted with door closer and door stopper. Kitchen: Solid core timber door finished with timber veneer and fitted with glass panel, door closer and door stopper. Master Bedroom, Bedroom, Master Bathroom, Bathroom, Guest Lavatory and Store Room 1: Hollow core timber door finished with timber veneer and fitted with lockset and door stopper. The doors of master bathroom and guest lavatory are fitted with louvers. Store Room 2: Aluminum framed glass folding door. F.S. Pump Room: Solid core timber door finished with plastic laminate and fitted with lockset, door closer and door stopper. Hose Reel Door: Timber door panel finished with timber veneer. Garden, Balcony and Flat Roof: Sliding glass door with PVF2 aluminum frame fitted with lockset. Roof Door: PVF2 aluminum framed glass door with lockset.
(b) Bathroom	Master Bathroom and bathroom are fitted with wooden mirror cabinet. All countertops are finished with artificial solid surface material. Fittings and equipment include vitreous china water closet, vitreous china wash basin, chrome plated towel bar and paper holder. Ventilation fan is provided. Copper pipes are used for cold water supply system and copper water pipes with thermal insulation for hot water supply. Master bathroom and bathroom are fitted with enameled cast iron bath tub (1500mm L x 750mm W x 420mm H) with chrome plated bath mixer and shower bar. Shower cubicle fitted with chrome plated shower water mixer are provided in master bathroom. For brand name and provisions of appliances, please refer to "Appliances Schedule".
(c) Kitchen	Kitchen cabinet is completed with chipboard carcass, high gloss lacquered surface door frontal and high gloss high pressure laminated surface door panel, and equipped with artificial solid surface work top, stainless steel sink and chrome plated sink mixer. Copper pipes are used for cold water supply system and copper water pipes with thermal insulation for hot water supply. For brand name and provisions of appliances, please refer to "Appliances Schedule".
(d) Bedroom	Nil
(e) Telephone	Telephone connection points are provided for living room, dining room, master bedroom and bedroom. For location and number of connection points, please refer to the "Schedule of Mechanical & Electrical Provisions".

83A, 83C, 83D, 83E, 83F and 83G Tan Kwai Tsuen Road, Casa Regalia

3. Interior Fittings	
Item	Description
(f) Aerials	TV/FM outlets for local TV/FM radio programmes are provided in living room, dining room, kitchen, master bedroom, bedroom and master bathroom. For location and number of connection points, please refer to the “Schedule of Mechanical & Electrical Provisions”.
(g) Electrical Installations	Three-phase electricity supply with miniature circuit breakers distribution boards completed with residual-current device is provided. Conduit wiring concealed in walls or enclosed in false ceilings or bulkheads or cabinets for lightings and power points are provided. For location and number of socket points and air conditioner points, please refer to the “Schedule of Mechanical & Electrical Provisions”.
(h) Gas Supply	Town gas supply pipes are provided and connected to gas cooking hob and gas water heater. Gas meter connection point is located in the kitchen of each individual house.
(i) Washing Machine Connection Point	Drain point and water point are located in the kitchen.
(j) Water Supply	Copper water pipes are provided for cold water supply and copper water pipes with thermal insulation are provided for hot water supply. Hot water supply system is provided to kitchen and bathroom. Both hot and cold water pipes are partly concealed and partly exposed. ¹

4. Miscellaneous	
Item	Description
(a) Lifts	Nil
(b) Letter Box	Metal letter box is provided for each individual house.
(c) Refuse Collection	A common refuse storage and material recovery chamber with vehicular access is provided at G/F for collection of refuse.
(d) Water Meter, Electricity Meter and Gas Meter	Separate water meter for each individual house is provided at water meter cabinet at B/F. Separate electricity meter for each individual house is provided at electricity meter cabinet at B/F. Space for separate gas meter is provided in the kitchen of each individual house.

5. Security Facilities	
Item	Description
Security System and Equipment	CCTV cameras are installed at B/F car park, recreational facilities, emergency vehicular access at G/F and boundary fence walls are connected to the caretaker’s office. Visitor panel for access control is provided at G/F entrance of each individual house connecting to video door phone of each individual house.

6. Appliances	
Item	Description
Appliances	For brand names and model numbers of appliances provided, please refer to the “Appliances Schedule”.

Notes:

- Other than those parts of the water pipes concealed with concrete, the rest of them are exposed. The exposed water pipes may be covered or hidden by false ceilings, bulkheads, cabinets, claddings, non-concrete partition walls, designated pipe ducts or other materials.

富豪·悅庭丹桂村路83A、83C、83D、83E、83F及83G號

賣方承諾如項目中沒有安裝指明的品牌名稱或產品型號的升降機或設備，便會安裝品質相若的升降機或設備。

1. 外部裝修物料	
細項	描述
(a) 外牆	鋪砌天然石材板、玻璃幕牆、油漆、鋁板及仿石磚。
(b) 窗	客廳、飯廳、廚房、主人睡房及睡房採用氟炭噴塗鋁窗框連灰面玻璃。 主人浴室及浴室選用氟炭噴塗鋁窗框連半透光灰面玻璃。
(c) 窗台	沒有。
(d) 花槽	花槽外鋪砌瓷磚。
(e) 陽台或露台	牆身鋪砌天然石材板及鋁板，地台鋪砌均質瓷磚及天然石墜，露台外露天花髹上乳膠漆。裝有玻璃欄杆。 為有蓋露台。 沒有陽台。
(f) 乾衣設施	沒有。

2. 室內裝修物料	
細項	描述
(a) 大堂	沒有。
(b) 內牆及天花板	內牆： 客廳、飯廳、主人睡房及睡房內外露牆髹乳膠漆。 天花板： 客廳、飯廳、主人睡房及睡房的天花板外露部份髹上乳膠漆，部分天花以石膏板鋪砌髹上乳膠漆。
(c) 內部地板	客廳、飯廳、主人睡房及睡房內部地板鋪砌複合木地板及木腳線。露台、花園或天台沿趟門之地台圍邊部分鋪砌天然石材。
(d) 浴室	主人浴室及浴室外露牆身鋪砌瓷磚及玻璃鏡面。外露地台鋪砌瓷磚。裝設石膏板假天花髹上乳膠漆。牆身飾面鋪砌至假天花高度。
(e) 廚房	外露牆身鋪砌瓷磚及玻璃鏡面。外露地台鋪砌瓷磚。裝設石膏板假天花髹上乳膠漆。灶台面為實心人造面板枱面。牆身飾面鋪砌至假天花高度。

3. 室內裝置	
細項	描述
(a) 門	地下防雨門： 氟炭噴塗鋁門框玻璃門，裝設門鎖。 地下單位大門： 木皮面實心木門。裝設門鎖、氣鼓、防盜眼及門阻。 地庫單位大門： 木皮面實心木門。裝設門鎖、氣鼓及門阻。 地庫樓梯旁木門： 木皮面實心木門。裝設氣鼓及門阻。 廚房： 木皮面實心木門配以玻璃。裝設氣鼓及門阻。 主人睡房、睡房、主人浴室、浴室、客人洗手間及儲物室 1： 木皮面空心木門。裝設門鎖及門阻。主人浴室及客人洗手間門設有百葉。 儲物室 2： 鋁門框玻璃摺門。 消防泵房： 膠板面實心木門。裝設門鎖、氣鼓及門阻。 消防喉轆門： 木皮面木門。 花園、露台及平台： 氟炭噴塗鋁框玻璃趟門，裝設門鎖。 天台門： 氟炭噴塗鋁門框玻璃門，裝設門鎖。
(b) 浴室	主人浴室及浴室選用木面鏡櫃。主人浴室及浴室選用實心人造面板檯面。裝置及設備包括陶瓷坐廁、陶瓷洗手盆、鍍鉻飾面毛巾架及廁紙架。設有抽氣扇。冷水喉採用銅喉管，熱水喉採用隔熱絕緣銅喉。 主人浴室及浴室設有瓷釉鑄鐵浴缸（1500 毫米長 x 750 毫米闊 x 420 毫米高），鍍鉻浴缸水龍頭及花灑水龍頭。 主人浴室淋浴間設有鍍鉻花灑水龍頭。 隨樓附送之設備及品牌，請參閱“設備說明表”。
(c) 廚房	廚櫃由高級刨花板櫃體、高光烤漆櫃門和高光高壓耐高溫飾面板櫃門組成；並配有實心人造面板檯面、不銹鋼水槽和鍍鉻單控水龍頭。冷水喉採用銅喉管，熱水喉採用隔熱絕緣銅喉。 隨樓附送之設備及品牌，請參閱“設備說明表”。
(d) 睡房	沒有。
(e) 電話	客廳、飯廳、主人睡房及睡房設有電話插座。 有關接駁點的位置及數量，請參考“機電裝置數量說明表”。

富豪·悅庭丹桂村路83A、83C、83D、83E、83F及83G號

3. 室內裝置	
細項	描述
(f) 天線	客廳、飯廳、廚房、主人睡房、睡房及主人浴室均裝設有可接收本地電視節目及電台節目的電視 / 收音機天線插座。 有關接駁點的位置及數量，請參考“機電裝置數量說明表”。
(g) 電力裝置	提供三相電力配電箱並裝置有漏電斷路器。照明及電插座之導管暗藏於牆身或置於假天花、假陣或櫃內。 有關電插座及空調機接駁點的位置及數量，請參考“機電裝置數量說明表”。
(h) 氣體供應	煤氣喉接駁煤氣煮食爐及煤氣熱水爐。單位之煤氣錶接駁點位於廚房內。
(i) 洗衣機接駁點	洗衣機配備來水及去水接駁點設在廚房。
(j) 供水	冷水喉採用銅喉及熱水喉採用配有隔熱絕緣保護之銅喉。 廚房及浴室有熱水供應。 冷熱水管是部分隱藏及部分外露。 ¹

4. 雜項	
細項	描述
(a) 升降機	沒有。
(b) 信箱	每座洋房設置金屬信箱。
(c) 垃圾收集	一個設有車輛通道公用垃圾儲存及物料回收房位於地下提供垃圾收集處理。
(d) 水錶、電錶及氣體錶	每座洋房之獨立水錶安裝於地庫水錶箱內。 每座洋房之獨立電錶安裝於地庫電錶箱內。 每座洋房之廚房內預留獨立煤氣錶位置。

5. 保安設施	
細項	描述
保安系統及設備	地庫停車場、康樂設施、地下緊急車輛通道及邊界圍牆均裝設有閉路電視，並連接管理員辦事處。 每座洋房地下入口裝有訪客視像對講機並連接該洋房內之視像對講機。

6. 設備	
細項	描述
設備	品牌名稱及產品型號：有關裝置和設備的品牌及產品型號，請參考“設備說明表”。

備註：

- 除部分隱藏於混凝土內之導管外，其他部分的導管均為外露。外露的導管可能被假天花、假陣、貯存櫃、覆面、非混凝土間牆、指定之槽位或其他物料遮蓋。

83B Tan Kwai Tsuen Road, Casa Regalia

The Vendor undertakes that if lifts or appliances of the specified brand name or model number are not installed in the Development, lifts or appliances of comparable quality will be installed.

1. Exterior Finishes	
Item	Description
(a) External Wall	Finished with natural stone cladding panels, curtain walls, paint, aluminum claddings and artificial granite tiles.
(b) Window	PVF2 aluminum window frames fitted with grey tinted glass for living room, dining room, kitchen, master bedroom and bedroom; PVF2 aluminum window frames fitted with obscured grey tinted glass for master bathroom and bathroom.
(c) Bay Window	Nil
(d) Planter	Externally finished with ceramic tiles.
(e) Verandah or balcony	Wall is finished with natural stone cladding and aluminum cladding. Floor is finished with homogenous tiles and natural stone tile curb. Exposed surfaces of ceilings of balcony are painted with emulsion paint. Fitted with glass balustrade. Balconies are covered. There is no verandah.
(f) Drying facilities for clothing	Nil

2. Interior Finishes	
Item	Description
(a) Lobby	Nil
(b) Internal wall and ceiling	Internal Walls: Exposed surfaces of internal walls of living and dining room are covered by wallpaper, glass panel, vinyl leather wall panel and stainless steel. Exposed surfaces of master bedroom are finished with wallpaper and mirror. Exposed surfaces of bedroom 1 is finished with wallpaper and stainless steel. Exposed surfaces of bedroom 2 is finished with wallpaper and fabric panel. Ceilings: Exposed surfaces of ceilings of living room, dining room, master bedroom and bedroom are finished with emulsion paint. Some areas are equipped with gypsum board false ceilings with emulsion paint.
(c) Internal floor	Living and dining room, master bedrooms and bedroom 1 are finished with ceramic tile. Bedroom 2 is finished with engineer wood flooring and stainless steel skirting.
(d) Bathroom	Exposed surfaces of walls are finished with ceramic tiles for bathroom; finished with natural stone for master bathroom. Exposed surfaces of floor are finished with ceramic tiles for bathroom and master bathroom 1; finished with natural stone for master bathroom 2. Gypsum board false ceilings with emulsion paint are provided. Wall finishes run up to false ceiling.
(e) Kitchen	Exposed surfaces of walls are finished with mirror and ceramic tiles up to false ceiling level. Exposed surfaces of floors are finished with ceramic tiles. Gypsum board false ceiling painted with emulsion paint are provided. Cooking bench top is fitted with artificial solid surface work top. Wall finishes run up to false ceiling.

3. Interior Fittings	
Item	Description
(a) Doors	Rain Door at G/F Entrance : PVF2 aluminum framed glass door fitted with lockset. Main Entrance at G/F: Solid core timber door finished with timber veneer at one side and emulsion paint at another side, and fitted with lockset, door closer, eye viewer and door stopper. Entrance of House at B/F: Solid core timber door finished with timber veneer and fitted with lockset, door closer, door stopper. Door adjacent to staircase at B/F: Solid core timber door finished with timber veneer and fitted with door closer and door stopper. Kitchen: Solid core timber door finished with timber veneer at one side and emulsion paint at another side, and fitted with door closer and door stopper. Master Bedroom, Bedroom, Master Bathroom 1 and Store Room 1: Hollow core timber door finished with timber veneer and fitted with lockset and door stopper. Guest Lavatory: Hollow core timber door finished with timber veneer at one side and emulsion paint at another side and fitted with door stopper and lock. Bathroom 1 and 2: Hollow core wooden sliding door finished with timber veneer. Master bathroom 2: Tempered glass door. Lavatory adjacent Store Room 1: Aluminum framed glass folding door. F.S. Pump Room: Solid core timber door finished with plastic laminate and fitted with lockset, door closer and door stopper. Hose Reel Door: Timber door panel finished with wallpaper. Garden, Balcony and Flat Roof: Sliding glass door with PVF2 aluminum frame fitted with lockset. Roof Door: PVF2 aluminum framed glass door with lockset.
(b) Bathroom	Master bathroom and bathroom are fitted with wooden mirror cabinet. All countertops are finished with natural stone. Fittings and equipment include vitreous china water closet, vitreous china wash basin, chrome plated basin mixer, chrome plated towel bar and paper holder. Ventilation fan is provided. Copper pipes are used for cold water supply system and copper water pipes with thermal insulation for hot water supply. Master bathroom and bathroom are fitted with enameled cast iron bath tub (1500mm L x 750mm W x 420mm H) with chrome plated bath mixer and shower bar. Shower cubicle fitted with chrome plated shower mixer are provided in master bathroom. For brand name and provisions of appliances, please refer to "Appliances Schedule".
(c) Kitchen	Kitchen cabinet is completed with chipboard carcass, high gloss lacquered surface door frontal and high gloss high pressure laminated surface door panel, and equipped with artificial solid surface work top, stainless steel sink and chrome plated sink mixer. Copper pipes are used for cold water supply system and copper water pipes with thermal insulation for hot water supply. For brand name and provisions of appliances, please refer to "Appliances Schedule".

83B Tan Kwai Tsuen Road, Casa Regalia

3. Interior Fittings	
Item	Description
(d) Bedroom	Nil
(e) Telephone	Telephone connection points are provided for living room, dining room, master bedroom and bedroom. For location and number of connection points, please refer to the “Schedule of Mechanical & Electrical Provisions”.
(f) Aerials	TV/FM outlets for local TV/FM radio programmes are provided in living and dining room, kitchen, master bedroom, bedroom and master bathroom. For location and number of connection points, please refer to the “Schedule of Mechanical & Electrical Provisions”.
(g) Electrical Installations	Three-phase electricity supply with miniature circuit breakers distribution boards completed with residual-current device is provided. Conduit wiring concealed in walls or enclosed in false ceilings or bulkheads or cabinets for lightings and power points are provided. For location and number of socket points and air conditioner points, please refer to the “Schedule of Mechanical & Electrical Provisions”.
(h) Gas Supply	Town gas supply pipes are provided and connected to gas cooking hob and gas water heater. Gas meter connection point is located in the kitchen of each individual house.
(i) Washing Machine Connection Point	Drain point and water point are located in the kitchen.
(j) Water Supply	Copper water pipes are provided for cold water supply and copper water pipes with thermal insulation are provided for hot water supply. Hot water supply system is provided to kitchen and bathroom. Both hot and cold water pipes are partly concealed and partly exposed. ¹

4. Miscellaneous	
Item	Description
(a) Lifts	Nil
(b) Letter Box	Metal letter box is provided for each individual house.
(c) Refuse Collection	A common refuse storage and material recovery chamber with vehicular access is provided at G/F for collection of refuse.
(d) Water Meter, Electricity Meter and Gas Meter	Separate water meter for each individual house is provided at water meter cabinet at B/F. Separate electricity meter for each individual house is provided at electricity meter cabinet at B/F. Space for separate gas meter is provided in the kitchen of each individual house.

5. Security Facilities	
Item	Description
Security System and Equipment	CCTV cameras are installed at B/F car park, recreational facilities, emergency vehicular access at G/F and boundary fence walls are connected to the caretaker’s office. Visitor panel for access control is provided at G/F entrance of each individual house connecting to video door phone of each individual house.

6. Appliances	
Item	Description
Appliances	For brand names and model numbers of appliances provided, please refer to the “Appliances Schedule”.

富豪·悅庭丹桂村路83B號

賣方承諾如項目中沒有安裝指明的品牌名稱或產品型號的升降機或設備，便會安裝品質相若的升降機或設備。

1. 外部裝修物料	
細項	描述
(a) 外牆	鋪砌天然石材板、玻璃幕牆、油漆、鋁板及衍石磚。
(b) 窗	客廳、飯廳、廚房、主人睡房及睡房採用氟炭噴塗鋁窗框連灰面玻璃。 主人浴室及浴室選用氟炭噴塗鋁窗框連半透光灰面玻璃。
(c) 窗台	沒有。
(d) 花槽	花槽外鋪砌瓷磚。
(e) 陽台或露台	牆身鋪砌天然石材板及鋁板，地台鋪砌均質瓷磚及天然石墜，露台外露天花鬆上乳膠漆。裝有玻璃欄杆。 為有蓋露台。 沒有陽台。
(f) 乾衣設施	沒有。

2. 室內裝修物料	
細項	描述
(a) 大堂	沒有。
(b) 內牆及天花板	內牆： 客廳、飯廳外露牆為牆紙、玻璃、人造皮裝飾板及不銹鋼。 主人房外露牆鋪砌牆紙及玻璃鏡面。 睡房 1 外露牆鋪砌牆紙及不銹鋼。 睡房 2 外露牆鋪砌牆紙及捫布。 天花板： 客廳、飯廳、主人睡房及睡房的天花板外露部份髹上乳膠漆，部分天花以石膏板鋪砌髹上乳膠漆。
(c) 內部地板	客廳、飯廳、主人睡房及睡房 1 內部地板鋪砌瓷磚。睡房 2 內部地板鋪砌複合木地板，腳線為不銹鋼。
(d) 浴室	浴室外露牆身鋪砌瓷磚。主人浴室外露牆身鋪砌天然石材。浴室及主人浴室 1 外露地台鋪砌瓷磚。主人浴室 2 外露地台鋪砌天然石材。裝設石膏板假天花髹上乳膠漆。牆身飾面鋪砌至假天花高度。
(e) 廚房	外露牆身鋪砌瓷磚及玻璃鏡面。外露地台鋪砌瓷磚。裝設石膏板假天花髹上乳膠漆。灶台面為實心人造面板枱面。牆身飾面鋪砌至假天花高度。

3. 室內裝置	
細項	描述
(a) 門	地下防雨門： 氟炭噴塗鋁門框玻璃門，裝設門鎖。 地下單位大門： 單面木皮，單面油漆實心木門。裝設門鎖、氣鼓、防盜眼及門阻。 地庫單位大門： 木皮面實心木門。裝設門鎖、氣鼓及門阻。 地庫樓梯旁木門： 木皮面實心木門。裝設氣鼓及門阻。 廚房： 單面木皮，單面油漆實心木門。裝設氣鼓及門阻。 主人睡房、睡房、主人浴室 1 及儲物室 1： 木皮面空心木門。裝設門鎖及門阻。 客人洗手間 單面木皮，單面油漆空心木門。裝設門阻及門鎖。 浴室 1 及 2： 木皮面空心木趟門。 主人浴室 2： 強化玻璃門。 儲物室 1 旁廁所： 鋁門框玻璃摺門。 消防泵房： 膠板面實心木門。裝設門鎖、氣鼓及門阻。 消防喉轆門： 牆紙面木門。 花園、露台及平台： 氟炭噴塗鋁框玻璃趟門，裝設門鎖。 天台門： 氟炭噴塗鋁門框玻璃門，裝設門鎖。
(b) 浴室	主人浴室及浴室選用木面鏡櫃。主人浴室及浴室選用天然石材檯面。裝置及設備包括陶瓷坐廁、陶瓷洗手盆、鍍鉻飾面水龍頭、鍍鉻飾面毛巾架及廁紙架。設有抽氣扇。冷水喉採用銅喉管，熱水喉採用隔熱絕緣銅喉。 主人浴室及浴室設有瓷釉鑄鐵浴缸 (1500 毫米長 x 750 毫米闊 x 420 毫米高)，鍍鉻浴缸水龍頭及花灑水龍頭。 主人浴室淋浴間設有鍍鉻花灑水龍頭。 隨樓附送之設備及品牌，請參閱“設備說明表”。
(c) 廚房	廚櫃由高級刨花板櫃體、高光烤漆櫃門和高光高壓耐高溫飾面板櫃門組成；並配有實心人造面板檯面、不銹鋼水槽和鍍鉻單控水龍頭。冷水喉採用銅喉管，熱水喉採用隔熱絕緣銅喉。 隨樓附送之設備及品牌，請參閱“設備說明表”。
(d) 睡房	沒有。
(e) 電話	客廳、飯廳、主人睡房及睡房設有電話插座。 有關接駁點的位置及數量，請參考“機電裝置數量說明表”。

富豪·悅庭丹桂村路83B號

3. 室內裝置	
細項	描述
(f) 天線	客廳、飯廳、廚房、主人睡房、睡房及主人浴室均裝設有可接收本地電視節目及電台節目的電視 / 收音機天線插座。 有關接駁點的位置及數量，請參考“機電裝置數量說明表”。
(g) 電力裝置	提供三相電力配電箱並裝置有漏電斷路器。照明及電插座之導管暗藏於牆身或置於假天花、假陣或櫃內。 有關電插座及空調機接駁點的位置及數量，請參考“機電裝置數量說明表”。
(h) 氣體供應	煤氣喉接駁煤氣煮食爐及煤氣熱水爐。單位之煤氣錶接駁點位於廚房內。
(i) 洗衣機接駁點	洗衣機配備來水及去水接駁點設在廚房。
(j) 供水	冷水喉採用銅喉及熱水喉採用配有隔熱絕緣保護之銅喉。 廚房及浴室有熱水供應。 冷熱水管是部分隱藏及部分外露。 ¹

4. 雜項	
細項	描述
(a) 升降機	沒有。
(b) 信箱	每座洋房設置金屬信箱。
(c) 垃圾收集	一個設有車輛通道公用垃圾儲存及物料回收房位於地下提供垃圾收集處理。
(d) 水錶、電錶及氣體錶	每座洋房之獨立水錶安裝於地庫水錶箱內。 每座洋房之獨立電錶安裝於地庫電錶箱內。 每座洋房之廚房內預留獨立煤氣錶位置。

5. 保安設施	
細項	描述
保安系統及設備	地庫停車場、康樂設施、地下緊急車輛通道及邊界圍牆均裝設有閉路電視，並連接管理員辦事處。 每座洋房地下入口裝有訪客視像對講機並連接該洋房內之視像對講機。

6. 設備	
細項	描述
設備	品牌名稱及產品型號：有關裝置和設備的品牌及產品型號，請參考“設備說明表”。

備註：

- 除部分隱藏於混凝土內之導管外，其他部分的導管均為外露。外露的導管可能被假天花、假陣、貯存櫃、覆面、非混凝土間牆、指定之槽位或其他物料遮蓋。

85A, 85B, 85C and 85D Tan Kwai Tsuen Road, Casa Regalia

The Vendor undertakes that if lifts or appliances of the specified brand name or model number are not installed in the Development, lifts or appliances of comparable quality will be installed.

1. Exterior Finishes	
Item	Description
(a) External Wall	Finished with natural stone cladding panels, curtain walls, paint, aluminum claddings and artificial granite tiles.
(b) Window	PVF2 aluminum window frames fitted with grey tinted glass for living room, dining room, kitchen, master bedroom and bedroom; PVF2 aluminum window frames fitted with obscured grey tinted glass for master bathroom and bathroom.
(c) Bay Window	Nil
(d) Planter	Externally finished with ceramic tiles.
(e) Verandah or balcony	Wall is finished with natural stone cladding and aluminum cladding. Floor is finished with homogenous tiles and natural stone tile curb. Exposed surfaces of ceilings of balcony are painted with emulsion paint. Fitted with glass balustrade. Balconies are covered. There is no verandah.
(f) Drying facilities for clothing	Nil

2. Interior Finishes	
Item	Description
(a) Lobby	Nil
(b) Internal wall and ceiling	Internal Walls: Exposed surfaces of internal walls of living room, dining room, master bedroom and bedroom are painted with emulsion paint. Ceilings: Exposed surfaces of ceilings of living room, dining room, master bedroom and bedroom are finished with emulsion paint. Some areas are equipped with gypsum board false ceilings with emulsion paint.
(c) Internal floor	Living room, dining room, master bedroom and bedroom are finished with engineering timber flooring and timber skirting with natural stone tiles adjoining sliding doors to balconies, gardens or flat roofs.
(d) Bathroom	Master bathroom and bathroom: Exposed surfaces of walls are finished with ceramic tiles and mirror. Exposed surfaces of floor are finished with ceramic tiles. Gypsum board false ceilings with emulsion paint are provided. Wall finishes run up to false ceiling.
(e) Kitchen	Exposed surfaces of walls are finished with mirror and ceramic tiles up to false ceiling level. Exposed surfaces of floors are finished with ceramic tiles. Gypsum board false ceiling painted with emulsion paint are provided. Cooking bench top is fitted with artificial solid surface work top. Wall finishes run up to false ceiling.

3. Interior Fittings	
Item	Description
(a) Doors	Rain Door at G/F Entrance : PVF2 aluminum framed glass door fitted with lockset. Main Entrance at G/F: Solid core timber door finished with timber veneer and fitted with lockset, door closer, eye viewer and door stopper. Entrance of House at B/F: Solid core timber door finished with timber veneer and fitted with lockset, door closer, door stopper. Door adjacent to staircase at B/F: Solid core timber door finished with timber veneer and fitted with door closer and door stopper. Kitchen: Solid core timber door finished with timber veneer and fitted with glass panel, door closer and door stopper. Master Bedroom, Bedroom, Master Bathroom, Bathroom (Except Bathroom 1), Guest Lavatory and Store Room 1: Hollow core timber door finished with timber veneer and fitted with lockset and door stopper. The doors of bathroom 2 and guest lavatory are fitted with louvers. Bathroom 1: Obscured sliding glass door Store Room 2: Aluminum framed glass folding door. F.S. Pump Room: Solid core timber door finished with plastic laminate and fitted with lockset, door closer and door stopper. Hose Reel Door: Timber door panel finished with timber veneer. Garden, Balcony and Flat Roof: Sliding glass door with PVF2 aluminum frame fitted with lockset. Roof Door: PVF2 Aluminum framed glass door with lockset.
(b) Bathroom	Master Bathroom and bathroom are fitted with wooden mirror cabinet. All countertops are finished with artificial solid surface material. Fittings and equipment include vitreous china water closet, vitreous china wash basin, chrome plated towel bar and paper holder. Ventilation fan is provided. Copper pipes are used for cold water supply system and copper water pipes with thermal insulation for hot water supply. Master bathroom is fitted with enameled cast iron bath tub (1700mm L x 750mm W x 420mm H) with chrome plated bath mixer and shower bar. Bathrooms are fitted with enameled cast iron bath tub (1500mm L x 750mm W x 420mm H) with chrome plated bath mixer and shower bar. Shower cubicle fitted with chrome finished shower water mixer are provided in master bathroom. For brand name and provisions of appliances, please refer to "Appliances Schedule".
(c) Kitchen	Kitchen cabinet is completed with chipboard carcass, high gloss lacquered surface door frontal and high gloss high pressure laminated surface door panel, and equipped with artificial solid surface work top, stainless steel sink and chrome plated sink mixer. Copper pipes are used for cold water supply system and copper water pipes with thermal insulation for hot water supply. For brand name and provisions of appliances, please refer to "Appliances Schedule".

85A, 85B, 85C and 85D Tan Kwai Tsuen Road, Casa Regalia

3. Interior Fittings	
Item	Description
(d) Bedroom	Nil
(e) Telephone	Telephone connection points are provided for living room, dining room, master bedroom and bedroom. For location and number of connection points, please refer to the “Schedule of Mechanical & Electrical Provisions”.
(f) Aerials	TV/FM outlets for local TV/FM radio programmes are provided in living room, dining room, kitchen, master bedroom, bedroom and master bathroom. For location and number of connection points, please refer to the “Schedule of Mechanical & Electrical Provisions”.
(g) Electrical Installations	Three-phase electricity supply with miniature circuit breakers distribution boards completed with residual-current device is provided. Conduit wiring concealed in walls or enclosed in false ceilings or bulkheads or cabinets for lightings and power points are provided. For location and number of socket points and air conditioner points, please refer to the “Schedule of Mechanical & Electrical Provisions”.
(h) Gas Supply	Town gas supply pipes are provided and connected to gas cooking hob and gas water heater. Gas meter connection point is located in the kitchen of each individual house.
(i) Washing Machine Connection Point	Drain point and water point are located in the kitchen.
(j) Water Supply	Copper water pipes are provided for cold water supply and copper water pipes with thermal insulation are provided for hot water supply. Hot water supply system is provided to kitchen and bathroom. Both hot and cold water pipes are partly concealed and partly exposed. ¹

4. Miscellaneous	
Item	Description
(a) Lifts	Nil
(b) Letter Box	Metal letter box is provided for each individual house.
(c) Refuse Collection	A common refuse storage and material recovery chamber with vehicular access is provided at G/F for collection of refuse.
(d) Water Meter, Electricity Meter and Gas Meter	Separate water meter for each individual house is provided at water meter cabinet at B/F. Separate electricity meter for each individual house is provided at electricity meter cabinet at B/F. Space for separate gas meter is provided in the kitchen of each individual house.

5. Security Facilities	
Item	Description
Security System and Equipment	CCTV cameras are installed at B/F car park, recreational facilities, emergency vehicular access at G/F and boundary fence walls are connected to the caretaker’s office. Visitor panel for access control is provided at G/F entrance of each individual house connecting to video door phone of each individual house.

6. Appliances	
Item	Description
Appliances	For brand names and model numbers of appliances provided, please refer to the “Appliances Schedule”.

Notes:

- Other than those parts of the water pipes concealed with concrete, the rest of them are exposed. The exposed water pipes may be covered or hidden by false ceilings, bulkheads, cabinets, claddings, non-concrete partition walls, designated pipe ducts or other materials.

富豪·悅庭丹桂村路85A、85B、85C及85D號

賣方承諾如項目中沒有安裝指明的品牌名稱或產品型號的升降機或設備，便會安裝品質相若的升降機或設備。

1. 外部裝修物料	
細項	描述
(a) 外牆	鋪砌天然石材板、玻璃幕牆、油漆、鋁板及仿石磚。
(b) 窗	客廳、飯廳、廚房、主人睡房及睡房採用氟炭噴塗鋁窗框連灰面玻璃。 主人浴室及浴室選用氟炭噴塗鋁窗框連半透光灰面玻璃。
(c) 窗台	沒有。
(d) 花槽	花槽外鋪砌瓷磚。
(e) 陽台或露台	牆身鋪砌天然石材板及鋁板，地台鋪砌均質瓷磚及天然石壘，露台外露天花鬆上乳膠漆。裝有玻璃欄杆。 為有蓋露台。 沒有陽台。
(f) 乾衣設施	沒有。

2. 室內裝修物料	
細項	描述
(a) 大堂	沒有。
(b) 內牆及天花板	內牆： 客廳、飯廳、主人睡房及睡房內外露牆髹乳膠漆。 天花板： 客廳、飯廳、主人睡房及睡房的天花板外露部份髹上乳膠漆，部分天花以石膏板鋪砌髹上乳膠漆。
(c) 內部地板	客廳、飯廳、主人睡房及睡房內部地板鋪砌複合木地板及木腳線。露台、花園或天台沿趟門之地台圍邊部分鋪砌天然石材。
(d) 浴室	主人浴室及浴室外牆身鋪砌瓷磚及玻璃鏡面。外露地台鋪砌瓷磚。裝設石膏板假天花髹上乳膠漆。牆身飾面鋪砌至假天花高度。
(e) 廚房	外露牆身鋪砌瓷磚及玻璃鏡面。外露地台鋪砌瓷磚。裝設石膏板假天花髹上乳膠漆。灶台面為實心人造面板枱面。牆身飾面鋪砌至假天花高度。

3. 室內裝置	
細項	描述
(a) 門	地下防雨門： 氟炭噴塗鋁門框玻璃門，裝設門鎖。 地下單位大門： 木皮面實心木門。裝設門鎖、氣鼓、防盜眼及門阻。 地庫單位大門 木皮面實心木門。裝設門鎖、氣鼓及門阻。 地庫樓梯旁木門： 木皮面實心木門。裝設氣鼓及門阻。 廚房： 木皮面實心木門配以玻璃。裝設氣鼓及門阻。 主人睡房、睡房、主人浴室、浴室（除浴室1外）、客人洗手間及儲物室1： 木皮面實心木門。裝設門鎖及門阻。浴室2及客人洗手間門設有百葉。 浴室1： 半透光玻璃趟門。 儲物室2： 鋁門框玻璃摺門。 消防泵房： 膠板面實心木門。裝設門鎖、氣鼓及門阻。 消防喉轆門： 木皮面木門。 花園、露台及平台： 氟炭噴塗鋁框玻璃趟門，裝設門鎖。 天台門： 氟炭噴塗鋁門框玻璃門，裝設門鎖。
(b) 浴室	主人浴室及浴室選用木面鏡櫃。主人浴室及浴室選用實心人造面板檯面。裝置及設備包括陶瓷坐廁、陶瓷洗手盆、鍍鉻飾面毛巾架及廁紙架。設有抽氣扇。冷水喉採用銅喉管，熱水喉採用隔熱絕緣銅喉。 主人浴室設有瓷釉鑄鐵浴缸（1700毫米長 x 750毫米闊 x 420毫米高），鍍鉻浴缸水龍頭及花灑水龍頭。 浴室設有瓷釉鑄鐵浴缸（1500毫米長 x 750毫米闊 x 420毫米高），鍍鉻浴缸水龍頭及花灑水龍頭。 主人浴室淋浴間設有鍍鉻花灑水龍頭。 隨樓附送之設備及品牌，請參閱“設備說明表”。
(c) 廚房	廚櫃由高級刨花板櫃體、高光烤漆櫃門和高光高壓耐高溫飾面板櫃門組成；並配有實心人造面板檯面、不銹鋼水槽和鍍鉻單控水龍頭。冷水喉採用銅喉管，熱水喉採用隔熱絕緣銅喉。 隨樓附送之設備及品牌，請參閱“設備說明表”。
(d) 睡房	沒有。

富豪·悅庭丹桂村路85A、85B、85C及85D號

3. 室內裝置	
細項	描述
(e) 電話	客廳、飯廳、主人睡房及睡房設有電話插座。 有關接駁點的位置及數量，請參考“機電裝置數量說明表”。
(f) 天線	客廳、飯廳、廚房、主人睡房、睡房及主人浴室均裝設有可接收本地電視節目及電台節目的電視 / 收音機天線插座。 有關接駁點的位置及數量，請參考“機電裝置數量說明表”。
(g) 電力裝置	提供三相電力配電箱並裝置有漏電斷路器。照明及電插座之導管暗藏於牆身或置於假天花、假陣或櫃內。 有關電插座及空調機接駁點的位置及數量，請參考“機電裝置數量說明表”。
(h) 氣體供應	煤氣喉接駁煤氣煮食爐及煤氣熱水爐。單位之煤氣錶接駁點位於廚房內。
(i) 洗衣機接駁點	洗衣機配備來水及去水接駁點設在廚房。
(j) 供水	冷水喉採用銅喉及熱水喉採用配有隔熱絕緣保護之銅喉。 廚房及浴室有熱水供應。 冷熱水管是部分隱藏及部分外露。 ¹

4. 雜項	
細項	描述
(a) 升降機	沒有。
(b) 信箱	每座洋房設置金屬信箱。
(c) 垃圾收集	一個設有車輛通道公用垃圾儲存及物料回收房位於地下提供垃圾收集處理。
(d) 水錶、電錶及氣體錶	每座洋房之獨立水錶安裝於地庫水錶箱內。 每座洋房之獨立電錶安裝於地庫電錶箱內。 每座洋房之廚房內預留獨立煤氣錶位置。

5. 保安設施	
細項	描述
保安系統及設備	地庫停車場、康樂設施、地下緊急車輛通道及邊界圍牆均裝設有閉路電視，並連接管理員辦事處。 每座洋房地下入口裝有訪客視像對講機並連接該洋房內之視像對講機。

6. 設備	
細項	描述
設備	品牌名稱及產品型號：有關裝置和設備的品牌及產品型號，請參考“設備說明表”。

備註：

- 除部分隱藏於混凝土內之導管外，其他部分的導管均為外露。外露的導管可能被假天花、假陣、貯存櫃、覆面、非混凝土間牆、指定之槽位或其他物料遮蓋。

87A, 87B, 87C, 87D and 85E Tan Kwai Tsuen Road, Casa Regalia

The Vendor undertakes that if lifts or appliances of the specified brand name or model number are not installed in the Development, lifts or appliances of comparable quality will be installed.

1. Exterior Finishes	
Item	Description
(a) External Wall	Finished with natural stone cladding panels, curtain walls, paint, aluminum claddings and artificial granite tiles.
(b) Window	PVF2 aluminum window frames fitted with grey tinted glass for living room, dining room, kitchen, master bedroom and bedroom; PVF2 aluminum window frames fitted with obscured grey tinted glass for master bathroom and bathroom.
(c) Bay Window	Nil
(d) Planter	Externally finished with ceramic tiles.
(e) Verandah or balcony	Wall is finished with natural stone cladding and aluminum cladding. Floor is finished with homogenous tiles and natural stone tile curb. Exposed surfaces of ceilings of balcony are painted with emulsion paint. Fitted with glass balustrade. Balconies are covered. There is no verandah.
(f) Drying facilities for clothing	Nil

2. Interior Finishes	
Item	Description
(a) Lobby	Nil
(b) Internal wall and ceiling	Internal Walls: Exposed surfaces of internal walls of living room, dining room, master bedroom and bedroom are painted with emulsion paint. Ceilings: Exposed surfaces of ceilings of living room, dining room, master bedroom and bedroom are finished with emulsion paint. Some areas are equipped with gypsum board false ceilings with emulsion paint.
(c) Internal floor	Living room, dining room, master bedroom and bedroom are finished with engineering timber flooring and timber skirting with natural stone tiles adjoining sliding doors to balconies, gardens or flat roofs.
(d) Bathroom	Master bathroom and bathroom: Exposed surfaces of walls are finished with ceramic tiles and mirror. Exposed surfaces of floor are finished with ceramic tiles. Gypsum board false ceilings with emulsion paint are provided. Wall finishes run up to false ceiling.
(e) Kitchen	Exposed surfaces of walls are finished with mirror and ceramic tiles up to false ceiling level. Exposed surfaces of floors are finished with ceramic tiles. Gypsum board false ceiling painted with emulsion paint are provided. Cooking bench top is fitted with artificial solid surface work top. Wall finishes run up to false ceiling.

3. Interior Fittings	
Item	Description
(a) Doors	Rain Door at G/F Entrance : PVF2 aluminum framed glass door fitted with lockset. Main Entrance at G/F: Solid core timber door finished with timber veneer and fitted with lockset, door closer, eye viewer and door stopper. Entrance of House at B/F: Solid core timber door finished with timber veneer and fitted with lockset, door closer, door stopper. Door adjacent to staircase at B/F: Solid core timber door finished with timber veneer and fitted with door closer and door stopper. Kitchen: Solid core timber door finished with timber veneer and fitted with glass panel, door closer and door stopper. Master Bedroom, Bedroom, Master Bathroom, Bathroom (Except Bathroom 1), Guest Lavatory and Store Room 1: Hollow core timber door finished with timber veneer and fitted with lockset and door stopper. The doors of bathroom 2 and guest lavatory are fitted with louvers. Bathroom 1: Obscured sliding glass door Store Room 2: Aluminum framed glass folding door. F.S. Pump Room: Solid core timber door finished with plastic laminate and fitted with lockset, door closer and door stopper. Hose Reel Door: Timber door panel finished with timber veneer. Garden, Balcony and Flat Roof: Sliding glass door with PVF2 aluminum frame fitted with lockset. Roof Door: PVF2 aluminum framed glass folding door with lockset.
(b) Bathroom	Master Bathroom and bathroom are fitted with wooden mirror cabinet. All countertops are finished with artificial solid surface material. Fittings and equipment include vitreous china water closet, vitreous china wash basin, chrome finished towel bar and paper holder. Ventilation fan is provided. Copper pipes are used for cold water supply system and copper water pipes with thermal insulation for hot water supply. Master bathroom is fitted with enameled cast iron bath tub (1700mm L x 750mm W x 420mm H) with chrome plated bath mixer and shower bar. Bathrooms are fitted with enameled cast iron bath tub (1500mm L x 750mm W x 420mm H) with chrome plated bath mixer and shower bar. Shower cubicle fitted with chrome plated shower water mixer are provided in master bathroom. For brand name and provisions of appliances, please refer to "Appliances Schedule".
(c) Kitchen	Kitchen cabinet is completed with chipboard carcass, high gloss lacquered surface door frontal and high gloss high pressure laminated surface door panel, and equipped with artificial solid surface work top, stainless steel sink and chrome plated sink mixer. Copper pipes are used for cold water supply system and copper water pipes with thermal insulation for hot water supply. For brand name and provisions of appliances, please refer to "Appliances Schedule".
(d) Bedroom	Nil

87A, 87B, 87C, 87D and 85E Tan Kwai Tsuen Road, Casa Regalia

3. Interior Fittings	
Item	Description
(e) Telephone	Telephone connection points are provided for living room, dining room, master bedroom and bedroom. For location and number of connection points, please refer to the “Schedule of Mechanical & Electrical Provisions”.
(f) Aerials	TV/FM outlets for local TV/FM radio programmes are provided in living room, dining room, kitchen, master bedroom, bedroom and master bathroom. For location and number of connection points, please refer to the “Schedule of Mechanical & Electrical Provisions”.
(g) Electrical Installations	Three-phase electricity supply with miniature circuit breakers distribution boards completed with residual-current device is provided. Conduit wiring concealed in walls or enclosed in false ceilings or bulkheads or cabinets for lightings and power points are provided. For location and number of socket points and air conditioner points, please refer to the “Schedule of Mechanical & Electrical Provisions”.
(h) Gas Supply	Town gas supply pipes are provided and connected to gas cooking hob and gas water heater. Gas meter connection point is located in the kitchen of each individual house.
(i) Washing Machine Connection Point	Drain point and water point are located in the kitchen.
(j) Water Supply	Copper water pipes are provided for cold water supply and copper water pipes with thermal insulation are provided for hot water supply. Hot water supply system is provided to kitchen and bathroom. Both hot and cold water pipes are partly concealed and partly exposed. ¹

4. Miscellaneous	
Item	Description
(a) Lifts	Nil
(b) Letter Box	Metal letter box is provided for each house.
(c) Refuse Collection	A common refuse storage and material recovery chamber with vehicular access is provided at G/F for collection of refuse.
(d) Water Meter, Electricity Meter and Gas Meter	Separate water meter for each individual house is provided at water meter cabinet at B/F. Separate electricity meter for each individual house is provided at electricity meter cabinet at B/F. Space for separate gas meter is provided in the kitchen of each individual house.

5. Security Facilities	
Item	Description
Security System and Equipment	CCTV cameras are installed at B/F car park, recreational facilities, emergency vehicular access at G/F and boundary fence walls are connected to the caretaker’s office. Visitor panel for access control is provided at G/F entrance of each individual house connecting to video door phone of each individual house.

6. Appliances	
Item	Description
Appliances	For brand names and model numbers of appliances provided, please refer to the “Appliances Schedule”.

Notes:

- Other than those parts of the water pipes concealed with concrete, the rest of them are exposed. The exposed water pipes may be covered or hidden by false ceilings, bulkheads, cabinets, claddings, non-concrete partition walls, designated pipe ducts or other materials.

富豪·悅庭丹桂村路87A、87B、87C、87D及87E號

賣方承諾如項目中沒有安裝指明的品牌名稱或產品型號的升降機或設備，便會安裝品質相若的升降機或設備。

1. 外部裝修物料	
細項	描述
(a) 外牆	鋪砌天然石材板、玻璃幕牆、油漆、鋁板及仿石磚。
(b) 窗	客廳、飯廳、廚房、主人睡房及睡房採用氟炭噴塗鋁窗框連灰面玻璃。 主人浴室及浴室選用氟炭噴塗鋁窗框連半透光灰面玻璃。
(c) 窗台	沒有。
(d) 花槽	花槽外鋪砌瓷磚。
(e) 陽台或露台	牆身鋪砌天然石材板及鋁板，地台鋪砌均質瓷磚及天然石壘，露台外露天花鬆上乳膠漆。裝有玻璃欄杆。 為有蓋露台。 沒有陽台。
(f) 乾衣設施	沒有。

2. 室內裝修物料	
細項	描述
(a) 大堂	沒有。
(b) 內牆及天花板	內牆： 客廳、飯廳、主人睡房及睡房內外露牆髹乳膠漆。 天花板： 客廳、飯廳、主人睡房及睡房的天花板外露部份髹上乳膠漆，部分天花以石膏板鋪砌髹上乳膠漆。
(c) 內部地板	客廳、飯廳、主人睡房及睡房內部地板鋪砌複合木地板及木腳線。露台、花園或天台沿趟門之地台圍邊部分鋪砌天然石材。
(d) 浴室	主人浴室及浴室外牆身鋪砌瓷磚及玻璃鏡面。外牆地台鋪砌瓷磚。裝設石膏板假天花髹上乳膠漆。牆身飾面鋪砌至假天花高度。
(e) 廚房	外牆牆身鋪砌瓷磚及玻璃鏡面。外牆地台鋪砌瓷磚。裝設石膏板假天花髹上乳膠漆。灶台面為實心人造面板枱面。牆身飾面鋪砌至假天花高度。

3. 室內裝置	
細項	描述
(a) 門	地下防雨門： 氟炭噴塗鋁門框玻璃門，裝設門鎖。 地下單位大門： 木皮面實心木門。裝設門鎖、氣鼓、防盜眼及門阻。 地庫單位大門： 木皮面實心木門。裝設門鎖、氣鼓及門阻。 地庫樓梯旁木門： 木皮面實心木門。裝設氣鼓及門阻。 廚房： 木皮面實心木門配以玻璃。裝設氣鼓及門阻。 主人睡房、睡房、主人浴室、浴室（除浴室1外）、客人洗手間及儲物室1： 木皮面空心木門。裝設門鎖及門阻。浴室2及客人洗手間門設有百葉。 浴室1： 半透光玻璃趟門。 儲物室2： 鋁門框玻璃摺門。 消防泵房： 膠板面實心木門。裝設門鎖、氣鼓及門阻。 消防喉轆： 木皮面木門。 花園、露台及平台： 氟炭噴塗鋁框玻璃趟門，裝設門鎖。 天台門： 氟炭噴塗鋁門框玻璃門，裝設門鎖。
(b) 浴室	主人浴室及浴室選用木面鏡櫃。主人浴室及浴室選用實心人造面板檯面。裝置及設備包括陶瓷坐廁、陶瓷洗手盆、鍍鉻飾面毛巾架及廁紙架。設有抽氣扇。冷水喉採用銅喉管，熱水喉採用隔熱絕緣銅喉。 主人浴室設有瓷釉鑄鐵浴缸（1700毫米長 x 750毫米闊 x 420毫米高），鍍鉻浴缸水龍頭及花灑水龍頭。 浴室設有瓷釉鑄鐵浴缸（1500毫米長 x 750毫米闊 x 420毫米高），鍍鉻浴缸水龍頭及花灑水龍頭。 主人浴室淋浴間設有鍍鉻花灑水龍頭。 隨樓附送之設備及品牌，請參閱“設備說明表”。
(c) 廚房	廚櫃由高級刨花板櫃體、高光烤漆櫃門和高光高壓耐高溫飾面板櫃門組成；並配有實心人造面板檯面、不銹鋼水槽和鍍鉻單控水龍頭。冷水喉採用銅喉管，熱水喉採用隔熱絕緣銅喉。 隨樓附送之設備及品牌，請參閱“設備說明表”。
(d) 睡房	沒有。

富豪·悅庭丹桂村路87A、87B、87C、87D及87E號

3. 室內裝置	
細項	描述
(e) 電話	客廳、飯廳、主人睡房及睡房設有電話插座。 有關接駁點的位置及數量，請參考“機電裝置數量說明表”。
(f) 天線	客廳、飯廳、廚房、主人睡房、睡房及主人浴室均裝設有可接收本地電視節目及電台節目的電視 / 收音機天線插座。 有關接駁點的位置及數量，請參考“機電裝置數量說明表”。
(g) 電力裝置	提供三相電力配電箱並裝置有漏電斷路器。照明及電插座之導管暗藏於牆身或置於假天花、假陣或櫃內。 有關電插座及空調機接駁點的位置及數量，請參考“機電裝置數量說明表”。
(h) 氣體供應	煤氣喉接駁煤氣煮食爐及煤氣熱水爐。單位之煤氣錶接駁點位於廚房內。
(i) 洗衣機接駁點	洗衣機配備來水及去水接駁點設在廚房。
(j) 供水	冷水喉採用銅喉及熱水喉採用配有隔熱絕緣保護之銅喉。 廚房及浴室有熱水供應。 冷熱水管是部分隱藏及部分外露。 ¹

4. 雜項	
細項	描述
(a) 升降機	沒有。
(b) 信箱	每座洋房設置金屬信箱。
(c) 垃圾收集	一個設有車輛通道公用垃圾儲存及物料回收房位於地下提供垃圾收集處理。
(d) 水錶、電錶及氣體錶	每座洋房之獨立水錶安裝於地庫水錶箱內。 每座洋房之獨立電錶安裝於地庫電錶箱內。 每座洋房之廚房內預留獨立煤氣錶位置。

5. 保安設施	
細項	描述
保安系統及設備	地庫停車場、康樂設施、地下緊急車輛通道及邊界圍牆均裝設有閉路電視，並連接管理員辦事處。 每座洋房地下入口裝有訪客視像對講機並連接該洋房內之視像對講機。

6. 設備	
細項	描述
設備	品牌名稱及產品型號：有關裝置和設備的品牌及產品型號，請參考“設備說明表”。

備註：

- 除部分隱藏於混凝土內之導管外，其他部分的導管均為外露。外露的導管可能被假天花、假陣、貯存櫃、覆面、非混凝土間牆、指定之槽位或其他物料遮蓋。

89 Tan Kwai Tsuen Road, Casa Regalia

The Vendor undertakes that if lifts or appliances of the specified brand name or model number are not installed in the Development, lifts or appliances of comparable quality will be installed.

1. Exterior Finishes	
Item	Description
(a) External Wall	Finished with natural stone cladding panels, curtain walls, paint, aluminum claddings and artificial granite tiles.
(b) Window	PVF2 aluminum window frames fitted with grey tinted glass for living room, dining room, kitchen, master bedroom and bedroom; PVF2 aluminum window frames fitted with obscured grey tinted glass for master bathroom and bathroom.
(c) Bay Window	Nil
(d) Planter	Externally finished with ceramic tiles.
(e) Verandah or balcony	Wall is finished with natural stone cladding and aluminum cladding. Floor is finished with homogenous tiles and natural stone tile curb. Exposed surfaces of ceilings of balcony are plastered and painted with emulsion paint. Fitted with glass balustrade. Balconies are covered. There is no verandah.
(f) Drying facilities for clothing	Nil

2. Interior Finishes	
Item	Description
(a) Lobby	Internal walls are finished with plaster up to the ceiling. Floors are finished with floor screeding. Ceilings are finished with concrete finish.
(b) Internal wall and ceiling	Internal Walls: Internal walls of living room, dining room, master bedroom and bedroom are finished with plaster up to the ceiling. Ceilings: Ceilings of living room, dining room, master bedroom and bedroom are finished with plaster.
(c) Internal floor	Living room, dining room, master bedroom and bedroom are finished with floor screeding. No skirting.
(d) Bathroom	Master bathroom and bathroom: Walls are finished with plaster up to ceiling level. Ceilings are finished with concrete finish. Floors are finished with floor screeding. No skirting.
(e) Kitchen	Exposed surfaces of walls are finished with mirror and ceramic tiles up to false ceiling level. Exposed surfaces of floors are finished with ceramic tiles. Gypsum board false ceiling painted with emulsion paint are provided. Cooking bench top is fitted with artificial solid surface work top.

3. Interior Fittings	
Item	Description
(a) Doors	Rain Door at G/F Entrance : PVF2 aluminum framed glass door fitted with lockset. Main Entrance at G/F: Solid core timber door finished with timber veneer and fitted with lockset, door closer, eye viewer and door stopper. Entrance of House at B/F: Solid core timber door finished with timber veneer and fitted with lockset, door closer, door stopper. Door adjacent to staircase at B/F: Solid core timber door finished with timber veneer and fitted with door closer and door stopper. Kitchen: Solid core timber door finished with timber veneer and fitted with glass panel, door closer and door stopper. Master Bedroom , Bedroom, Guest Lavatory, Store Room 1 and 2: Hollow core timber door finished with timber veneer and fitted with lockset and door stopper. Master Bathroom: Obscured sliding glass door Lavatory adjacent Store Room 1: Aluminum framed glass folding door. F.S. Pump Room: Solid core timber door finished with plastic laminate and fitted with lockset, door closer and door stopper. Hose Reel Door: Timber door panel. Garden, Balcony and Flat Roof: Sliding glass door with PVF2 aluminum frame fitted with lockset. Roof Door: PVF2 aluminum framed glass door with lockset.
(b) Bathroom	Master bathroom and bathroom are fitted with vitreous china wash basin, chrome finished water mixer and vitreous china water closet. Ventilation fan is provided. Copper pipes are used for cold water supply system and copper water pipes with thermal insulation for hot water supply. For brand name and provisions of appliances, please refer to "Appliances Schedule".
(c) Kitchen	Kitchen cabinet is completed with chipboard carcass, high gloss lacquered surface door frontal and high gloss high pressure laminated surface door panel, and equipped with artificial solid surface work top, stainless steel sink and chrome plated sink mixer. Copper pipes are used for cold water supply system and copper water pipes with thermal insulation for hot water supply. For brand name and provisions of appliances, please refer to "Appliances Schedule".
(d) Bedroom	Nil

89 Tan Kwai Tsuen Road, Casa Regalia

3. Interior Fittings	
Item	Description
(e) Telephone	Telephone connection points are provided for living room, dining room, master bedroom, bedroom and family room. For location and number of connection points, please refer to the "Schedule of Mechanical & Electrical Provisions".
(f) Aerials	TV/FM outlets for local TV/FM radio programmes are provided in living room, dining room, kitchen, master bedroom, bedroom, master bathroom and family room. For location and number of connection points, please refer to the "Schedule of Mechanical & Electrical Provisions".
(g) Electrical Installations	Three-phase electricity supply with miniature circuit breakers distribution boards completed with residual-current device is provided. Conduit wiring concealed in walls or enclosed in false ceilings or bulkheads or cabinets for lightings and power points are provided. For location and number of socket points and air conditioner points, please refer to the "Schedule of Mechanical & Electrical Provisions".
(h) Gas Supply	Town gas supply pipes are provided and connected to gas cooking hob and gas water heater. Gas meter connection point is located in the kitchen of the house.
(i) Washing Machine Connection Point	Drain point and water point are located in the kitchen.
(j) Water Supply	Copper water pipes are provided for cold water supply and copper water pipes with thermal insulation are provided for hot water supply. Hot water supply system is provided to kitchen and bathroom. Both hot and cold water pipes are partly concealed and partly exposed. ¹

4. Miscellaneous	
Item	Description
(a) Lifts	1 no. of "Fujitect" lift (model no. ML-GSh) serving the B/F, G/F, 1/F and 2/F.
(b) Letter Box	Metal letter box is provided for the house.
(c) Refuse Collection	A common refuse storage and material recovery chamber with vehicular access is provided at G/F for collection of refuse.
(d) Water Meter, Electricity Meter and Gas Meter	Separate water meter is provided at water meter cabinet at B/F. Separate electricity meter is provided at electricity meter cabinet at B/F. Space for separate gas meter is provided in the kitchen.

5. Security Facilities	
Item	Description
Security System and Equipment	CCTV cameras are provided at B/F car park, recreational facilities, emergency vehicular access at G/F and boundary fence walls and connected to caretaker's office. Visitor panel for access control is provided at G/F entrance of the house connecting to video door phone of the house.

6. Appliances	
Item	Description
Appliances	For brand names and model numbers of appliances provided, please refer to the "Appliances Schedule".

Notes:

- Other than those parts of the water pipes concealed with concrete, the rest of them are exposed. The exposed water pipes may be covered or hidden by false ceilings, bulkheads, cabinets, claddings, non-concrete partition walls, designated pipe ducts or other materials.

富豪·悅庭丹桂村路89號

賣方承諾如項目中沒有安裝指明的品牌名稱或產品型號的升降機或設備，便會安裝品質相若的升降機或設備。

1. 外部裝修物料	
細項	描述
(a) 外牆	鋪砌天然石材板、玻璃幕牆、油漆、鋁板及仿石磚。
(b) 窗	客廳、飯廳、主人睡房、睡房及廚房採用氟炭噴塗鋁窗框連灰面玻璃。主人浴室及浴室選用氟炭噴塗鋁窗框連半透光灰面玻璃。
(c) 窗台	沒有。
(d) 花槽	花槽外鋪砌瓷磚。
(e) 陽台或露台	牆身鋪砌天然石材板及鋁板，地台鋪砌均質瓷磚及天然石墜，露台外露天花糝上乳膠漆。裝有玻璃欄杆。 為有蓋露台。 沒有陽台。
(f) 乾衣設施	沒有。

2. 室內裝修物料	
細項	描述
(a) 大堂	內牆為批盪面至天花，地板為批盪面，天花為混凝土面。
(b) 內牆及天花板	內牆： 客廳、飯廳、主人睡房及睡房內為批盪面至天花。 天花板： 客廳、飯廳、主人睡房及睡房的天花板為批盪面。
(c) 內部地板	客廳、飯廳、主人睡房及睡房內部地板為批盪面。沒有腳線。
(d) 浴室	主人浴室及浴室牆身為批盪面至天花。天花為混凝土面。地台為批盪面。沒有腳線。
(e) 廚房	外露牆身鋪砌瓷磚及玻璃鏡面。外露地台鋪砌瓷磚。裝設石膏板假天花糝上乳膠漆。灶台面為實心人造面板枱面。牆身飾面鋪砌至假天花高度。

3. 室內裝置	
細項	描述
(a) 門	地下防雨門： 氟炭噴塗鋁門框玻璃門，裝設門鎖。 地下單位大門： 木皮面實心木門。裝設門鎖、氣鼓、防盜眼及門阻。 地庫單位大門： 木皮面實心木門。裝設門鎖、氣鼓及門阻。 地庫樓梯旁木門： 木皮面實心木門。裝設氣鼓及門阻。 廚房： 木皮面實心木門配以玻璃。裝設氣鼓及門阻。 主人睡房、睡房、浴室、儲物室 1 及 2： 木皮面空心木門。裝設門鎖及門阻。 主人浴室： 半透光玻璃趟門。 儲物室旁廁所： 鋁門框玻璃摺門。 消防泵房： 膠板面實心木門。裝設門鎖、氣鼓及門阻。 消防喉轆： 木門板。 花園、露台及平台： 氟炭噴塗鋁框玻璃趟門，裝設門鎖。 天台門： 氟炭噴塗鋁門框玻璃門，裝設門鎖。
(b) 浴室	主人浴室及浴室裝置及設備包括陶瓷坐廁、陶瓷洗手盆及鍍鉻水龍頭。設有抽氣扇。冷水喉採用銅喉管，熱水喉採用隔熱絕緣銅喉。隨樓附送之設備及品牌，請參閱“設備說明表”。
(c) 廚房	廚櫃由高級刨花板櫃體、高光烤漆櫃門和高光高壓耐高溫飾面板櫃門組成；並配有實心人造面板檯面、不銹鋼水槽和鍍鉻單控水龍頭。冷水喉採用銅喉管，熱水喉採用隔熱絕緣銅喉。隨樓附送之設備及品牌，請參閱“設備說明表”。
(d) 睡房	沒有。

富豪·悅庭丹桂村路89號

3. 室內裝置	
細項	描述
(e) 電話	客廳、飯廳、主人睡房、睡房及家庭室設有電話插座。 有關接駁點的位置及數量，請參考“機電裝置數量說明表”。
(f) 天線	客廳、飯廳、廚房、主人睡房、睡房、主人浴室及家庭室均裝設有可接收本地電視節目及電台節目的電視 / 收音機天線插座。 有關接駁點的位置及數量，請參考“機電裝置數量說明表”。
(g) 電力裝置	提供三相電力配電箱並裝置有漏電斷路器。照明及電插座之導管暗藏於牆身或置於假天花、假陣或櫃內。 有關電插座及空調機接駁點的位置及數量，請參考“機電裝置數量說明表”。
(h) 氣體供應	煤氣喉接駁煤氣煮食爐及煤氣熱水爐。單位之煤氣錶接駁點位於廚房內。
(i) 洗衣機接駁點	洗衣機配備來水及去水接駁點設在廚房。
(j) 供水	冷水喉採用銅喉及熱水喉採用配有隔熱絕緣保護之銅喉。 廚房及浴室有熱水供應。 冷熱水管是部分隱藏及部分外露。 ¹

4. 雜項	
細項	描述
(a) 升降機	1 部“富士達”升降機（型號：ML-GSh）直達地庫、地下、一樓及二樓。
(b) 信箱	設置金屬信箱。
(c) 垃圾收集	一個設有車輛通道公用垃圾儲存及物料回收房位於地下提供垃圾收集處理。
(d) 水錶、電錶及氣體錶	獨立水錶安裝於地庫水錶箱內。 獨立電錶安裝於地庫電錶箱內。 廚房內預留獨立煤氣錶位置。

5. 保安設施	
細項	描述
保安系統及設備	地庫停車場、康樂設施、地下緊急車輛通道及邊界圍牆均裝設有閉路電視，並連接管理員辦事處。 洋房地下入口裝有訪客視像對講機並連接該洋房內之視像對講機。

6. 設備	
細項	描述
設備	品牌名稱及產品型號：有關裝置和設備的品牌及產品型號，請參考“設備說明表”。

備註：

- 除部分隱藏於混凝土內之導管外，其他部分的導管均為外露。外露的導管可能被假天花、假陣、貯存櫃、覆面、非混凝土間牆、指定之槽位或其他物料遮蓋。

Appliances Schedule 設備說明表

Domus 尚築

Location 位置	Appliance 設備	Brand 品牌 / Model Number 型號	
		Outdoor 室外機	Indoor 室內機
Living/Dining Room in Flat 1 to 28 and Flat 31 to 38 (G/F), Flat 1 to 29 and Flat 32 to 39 (1/F to 2/F), Flat 1 to 28, Flat 30 and 32-39 (3/F) 地下單位1至28及31至38、一樓至二樓單位1至29及32至39、三樓單位1至28, 單位30及32至39之飯廳及客廳	Split-type Air-conditioner 分體式空調機	Mcquay 麥克維爾 / M5LC15C	Mcquay 麥克維爾 / M5WM15G
Living/Dining Room in Flat 29 and 30 (G/F), Flat 30 and 31(1/F to 2/F) and Flat 31 (3/F) 地下單位29及30、一樓至二樓單位30及31、三樓單位31飯廳及客廳	Split-type Air-conditioner 分體式空調機	Mcquay 麥克維爾 / M5LC25C	Mcquay 麥克維爾 / M5WM25G
Bedroom in Flat 30 (3/F) 三樓單位30之睡房	Split-type Air-conditioner 分體式空調機	Mcquay 麥克維爾 / M5LC25C	Mcquay 麥克維爾 / M5WM25G
Open Kitchen 開放式廚房	Microwave Oven 微波爐	Cristal 尼斯 / C17L-700ASP	
	Induction Hob 電磁爐	Cristal 尼斯 / PE2926ID	
	Cooker hood 600mm 600毫米抽油煙機	Cristal 尼斯 / T60ES	
	Refrigerator 雪櫃	Smeg / FL130A	
Bathroom 浴室	Exhaust Fan 抽氣扇	Rosenberg 洛森 / RDI 200B	
	Electric Water Heater 電熱水爐	Zanker 愛家 / DE 18	

The Vendor undertakes that if lifts or appliances of the specified brand name or model number are not installed in the Development, lifts or appliances of comparable quality will be installed.

賣方承諾如該發展項目中沒有安裝指明的品牌名稱或產品型號的升降機或設備，便會安裝品質相若的升降機或設備。

FITTINGS, FINISHES AND APPLIANCES

裝置、裝修物料及設備

67A, 67B, 69A and 69B Tan Kwai Tsuen Road, Casa Regalia
 富豪·悅庭丹桂村路67A、67B、69A及69B號

Location 位置	Appliance 設備	Brand 品牌 / Model Number 型號	
		Outdoor 室外機	Indoor 室內機
Living Room 客廳	VRV Multi Air-Conditioning System VRV分體式空調	Mcquay 麥克維爾 / MDS120BR5	Mcquay 麥克維爾 / MCC028TP
Dining Room 飯廳	VRV Multi Air-Conditioning System VRV分體式空調		Mcquay 麥克維爾 / MCC018TP
Master Bedroom 1 主人睡房 1	VRV Multi Air-Conditioning System VRV分體式空調		Mcquay 麥克維爾 / MWM020VP
Master Bedroom 2 主人睡房 2	VRV Multi Air-Conditioning System VRV分體式空調		Mcquay 麥克維爾 / MWM020VP
Bedroom 1 睡房 1	VRV Multi Air-Conditioning System VRV分體式空調		Mcquay 麥克維爾 / MWM015VP
Bedroom 2 睡房 2	VRV Multi Air-Conditioning System VRV分體式空調		Mcquay 麥克維爾 / MWM015VP
Kitchen 廚房	Microwave Oven 微波爐	Bauknecht / EMCHT9145	
	Steamer 蒸爐	Bauknecht / ESTM9145	
	2 Burner Gas Hob 雙頭氣體煮食爐	Bauknecht / TGZ6260	
	Wok Burner 單頭氣體煮食爐	Bauknecht / TGC6180	
	Induction Hob 電磁爐	Bauknecht / ETI6260	
	Cookerhood 900mm 900毫米抽油煙機	Bauknecht / DWGR8410	
	Wine Cooler 酒櫃	Whirlpool / ARC1500	
	Refrigerator 雪櫃	Bauknecht / KSN1183	
	2 in 1 Washer dryer 洗衣乾衣機	Whirlpool / AWI 64120	
	11.6" Full HD LED TV 11.6吋LED高清電視	Cristal 尼斯 / CTV-121	
	Exhaust Fan 抽氣扇	Rosenberg 洛森 / RDI 200C	
Master Bathroom 1 主人浴室 1	17.1" Waterproof TV 17.1吋防水電視	Cristal 尼斯 / BKW-171	
	Exhaust Fan 抽氣扇	Rosenberg 洛森 / RDI 200C	
Master Bathroom 2 主人浴室 2	17.1" Waterproof TV 17.1吋防水電視	Cristal 尼斯 / BKW-171	
	Exhaust Fan 抽氣扇	Rosenberg 洛森 / RDI 200C	
Bathroom 1 浴室 1	Exhaust Fan 抽氣扇	Rosenberg 洛森 / RDI 200C	
Bathroom 2 浴室 2	Exhaust Fan 抽氣扇	Rosenberg 洛森 / RDI 200C	
Guest Lavatory 賓客洗手間	Exhaust Fan 抽氣扇	Rosenberg 洛森 / RDI 200B	
Store Room 1 儲物室 1	Exhaust Fan 抽氣扇	Rosenberg 洛森 / RDI 200C	
Store Room 2 儲物室 2	Exhaust Fan 抽氣扇	Rosenberg 洛森 / RDI 200B	
Roof 天台	Gas Water Heater 煤氣熱水爐	TGC TNJW221TFQL	

The Vendor undertakes that if lifts or appliances of the specified brand name or model number are not installed in the Development, lifts or appliances of comparable quality will be installed.

賣方承諾如該發展項目中沒有安裝指明的品牌名稱或產品型號的升降機或設備，便會安裝品質相若的升降機或設備。

71A, 71B, 73A and 73B Tan Kwai Tsuen Road, Casa Regalia
 富豪·悦庭丹桂村路71A、71B、73A、73B號

Location 位置	Appliance 設備	Brand 品牌 / Model Number 型號	
		Outdoor 室外機	Indoor 室內機
Living Room 客廳	VRV Multi Air-Conditioning System VRV分體式空調	Mcquay 麥克維爾 / MDS120BR5	Mcquay 麥克維爾 / MCC028TP
Dining Room 飯廳	VRV Multi Air-Conditioning System VRV分體式空調		Mcquay 麥克維爾 / MCC018TP
Master Bedroom 1 主人睡房 1	VRV Multi Air-Conditioning System VRV分體式空調		Mcquay 麥克維爾 / MWM020VP
Master Bedroom 2 主人睡房 2	VRV Multi Air-Conditioning System VRV分體式空調		Mcquay 麥克維爾 / MWM020VP
Bedroom 1 睡房 1	VRV Multi Air-Conditioning System VRV分體式空調		Mcquay 麥克維爾 / MWM015VP
Bedroom 2 睡房 2	VRV Multi Air-Conditioning System VRV分體式空調		Mcquay 麥克維爾 / MWM015VP
Roof in 71B Tan Kwai Tsuen Road, Casa Regalia 富豪·悦庭丹桂村路71B天台	Split-type Air-Conditioner 分體式空調機	Mcquay 麥克維爾 / M5LC20C	Mcquay 麥克維爾 / M5WM20L
Kitchen 廚房	Microwave Oven 微波爐	Bauknecht / EMCHT9145	
	Steamer 蒸爐	Bauknecht / ESTM9145	
	2 Burner Gas Hob 雙頭氣體煮食爐	Bauknecht / TGZ6260	
	Wok Burner 單頭氣體煮食爐	Bauknecht / TGC6180	
	Induction Hob 電磁爐	Bauknecht / ETI6260	
	Cookerhood 900mm 900毫米抽油煙機	Bauknecht / DWGR8410	
	Wine Cooler 酒櫃	Whirlpool / ARC1500	
	Refrigerator 雪櫃	Bauknecht / KSN1183	
	2 in 1 Washer dryer 洗衣乾衣機	Whirlpool / AWI 64120	
	11.6" Full HD LED TV 11.6吋LED高清電視	Cristal 尼斯 / CTV-121	
	Exhaust Fan 抽氣扇	Rosenberg 洛森 / RDI 200C	

Location 位置	Appliance 設備	Brand 品牌 / Model Number 型號	
		Outdoor 室外機	Indoor 室內機
Master Bathroom 1 主人浴室 1	17.1" Waterproof TV 17.1吋防水電視	Cristal 尼斯 / BKW-171	
	Exhaust Fan 抽氣扇	Rosenberg 洛森 / RDI 200C	
Master Bathroom 2 主人浴室 2	17.1" Waterproof TV 17.1吋防水電視	Cristal 尼斯 / BKW-171	
	Exhaust Fan 抽氣扇	Rosenberg 洛森 / RDI 200C	
Bathroom 1 浴室 1	Exhaust Fan 抽氣扇	Rosenberg 洛森 / RDI 200C	
Bathroom 2 浴室 2	Exhaust Fan 抽氣扇	Rosenberg 洛森 / RDI 200C	
Guest Lavatory 賓客洗手間	Exhaust Fan 抽氣扇	Rosenberg 洛森 / RDI 200B	
Store Room 1 儲物室 1	Exhaust Fan 抽氣扇	Rosenberg 洛森 / RDI 200C	
Store Room 2 in 71B, 73A and 73B Tan Kwai Tsuen Road, Casa Regalia 富豪·悦庭丹桂村路71B、73A及73B號儲存室2	Exhaust Fan 抽氣扇	Rosenberg 洛森 / RDI 200B	
Lavatory adjacent to Store Room 1 in 71A Tan Kwai Tsuen Road, Casa Regalia 富豪·悦庭丹桂村路71A號儲存室1旁洗手間	Exhaust Fan 抽氣扇	Rosenberg 洛森 / RDI 200B	
Roof 天台	Gas Water Heater 煤氣熱水爐	TGC TNJW221TFQL	

The Vendor undertakes that if lifts or appliances of the specified brand name or model number are not installed in the Development, lifts or appliances of comparable quality will be installed.

賣方承諾如該發展項目中沒有安裝指明的品牌名稱或產品型號的升降機或設備，便會安裝品質相若的升降機或設備。

FITTINGS, FINISHES AND APPLIANCES
裝置、裝修物料及設備

75A Tan Kwai Tsuen Road, Casa Regalia
 富豪·悦庭丹桂村路75A號

Location 位置	Appliance 設備	Brand 品牌 / Model Number 型號	
		Outdoor 室外機	Indoor 室內機
Living Room 客廳	VRV Multi Air-Conditioning System VRV分體式空調	Mcquay 麥克維爾 / MDS080BR5	Mcquay 麥克維爾 / MCC028TP
Dining Room 飯廳	VRV Multi Air-Conditioning System VRV分體式空調		Mcquay 麥克維爾 / MCC018TP
Master Bedroom 主人睡房	VRV Multi Air-Conditioning System VRV分體式空調		Mcquay 麥克維爾 / MCC020TP
Bedroom 1 睡房 1	VRV Multi Air-Conditioning System VRV分體式空調		Mcquay 麥克維爾 / MWM020VP
Bedroom 2 睡房 2	VRV Multi Air-Conditioning System VRV分體式空調		Mcquay 麥克維爾 / MWM015VP
Kitchen 廚房	Microwave Oven 微波爐	Bauknecht / EMCHT9145	
	Steamer 蒸爐	Bauknecht / ESTM9145	
	2 Burner Gas Hob 雙頭氣體煮食	Bauknecht / TGZ6260	
	Wok Burner 單頭氣體煮食爐	Bauknecht / TGC6180	
	Induction Hob 電磁爐	Bauknecht / ETI6260	
	Cookerhood 900mm 900毫米抽油煙機	Bauknecht / DWGR8410	
	Wine Cooler 酒櫃	Whirlpool / ARC1500	
	Refrigerator 雪櫃	Bauknecht / KSN1183	
	2 in 1 Washer dryer 洗衣乾衣機	Whirlpool / AWI 64120	
	11.6" Full HD LED TV 11.6吋LED高清電視	Cristal 尼斯 / CTV-121	
Exhaust Fan 抽氣扇	Rosenberg 洛森 / RDI 200C		
Master Bathroom 主人浴室	17.1" Waterproof TV 17.1吋防水電視	Cristal 尼斯 / BKW-171	
	Exhaust Fan 抽氣扇	Rosenberg 洛森 / RDI 200C	
Bathroom 1 浴室 1	Exhaust Fan 抽氣扇	Rosenberg 洛森 / RDI 200C	
Bathroom 2 浴室 2	Exhaust Fan 抽氣扇	Rosenberg 洛森 / RDI 200C	
Guest Lavatory 賓客洗手間	Exhaust Fan 抽氣扇	Rosenberg 洛森 / RDI 200B	
Store Room 1 儲物室 1	Exhaust Fan 抽氣扇	Rosenberg 洛森 / RDI 200C	
Store Room 2 in 75B, 77A and 77B Tan Kwai Tsuen Road, Casa Regalia 富豪·悦庭 丹桂村路75B、77A及77B號 儲存室2	Exhaust Fan 抽氣扇	Rosenberg 洛森 / RDI 200B	
Lavatory adjacent to Store Room 1 in 75A Tan Kwai Tsuen Road, Casa Regalia 富豪·悦庭 丹桂村路75A號 儲存室1旁洗手間	Exhaust Fan 抽氣扇	Rosenberg 洛森 / RDI 200B	
Roof 天台	Gas Water Heater 煤氣熱水爐	TGC TNJW221TFQL	

75B, 77A and 77B Tan Kwai Tsuen Road, Casa Regalia
 富豪·悦庭丹桂村路75B、77A、77B號

Location 位置	Appliance 設備	Brand 品牌 / Model Number 型號	
		Outdoor 室外機	Indoor 室內機
Living Room 客廳	VRV Multi Air-Conditioning System VRV分體式空調	Mcquay 麥克維爾 / MDS080BR5	Mcquay 麥克維爾 / MCC028TP
Dining Room 飯廳	VRV Multi Air-Conditioning System VRV分體式空調		Mcquay 麥克維爾 / MCC018TP
Master Bedroom 主人睡房	VRV Multi Air-Conditioning System VRV分體式空調		Mcquay 麥克維爾 / MWM020VP
Bedroom 1 睡房 1	VRV Multi Air-Conditioning System VRV分體式空調		Mcquay 麥克維爾 / MWM020VP
Bedroom 2 睡房 2	VRV Multi Air-Conditioning System VRV分體式空調		Mcquay 麥克維爾 / MWM015VP
Kitchen 廚房	Microwave Oven 微波爐	Bauknecht / EMCHT9145	
	Steamer 蒸爐	Bauknecht / ESTM9145	
	2 Burner Gas Hob 雙頭氣體煮食	Bauknecht / TGZ6260	
	Wok Burner 單頭氣體煮食爐	Bauknecht / TGC6180	
	Induction Hob 電磁爐	Bauknecht / ETI6260	
	Cookerhood 900mm 900毫米抽油煙機	Bauknecht / DWGR8410	
	Wine Cooler 酒櫃	Whirlpool / ARC1500	
	Refrigerator 雪櫃	Bauknecht / KSN1183	
	2 in 1 Washer dryer 洗衣乾衣機	Whirlpool / AWI 64120	
	11.6" Full HD LED TV 11.6吋LED高清電視	Cristal 尼斯 / CTV-121	
Exhaust Fan 抽氣扇	Rosenberg 洛森 / RDI 200C		
Master Bathroom 主人浴室	17.1" Waterproof TV 17.1吋防水電視	Cristal 尼斯 / BKW-171	
	Exhaust Fan 抽氣扇	Rosenberg 洛森 / RDI 200C	
Bathroom 1 浴室 1	Exhaust Fan 抽氣扇	Rosenberg 洛森 / RDI 200C	
Bathroom 2 浴室 2	Exhaust Fan 抽氣扇	Rosenberg 洛森 / RDI 200C	
Guest Lavatory 賓客洗手間	Exhaust Fan 抽氣扇	Rosenberg 洛森 / RDI 200B	
Store Room 1 儲物室 1	Exhaust Fan 抽氣扇	Rosenberg 洛森 / RDI 200C	
Store Room 2 in 75B, 77A and 77B Tan Kwai Tsuen Road, Casa Regalia 富豪·悦庭 丹桂村路75B、77A及77B號 儲存室2	Exhaust Fan 抽氣扇	Rosenberg 洛森 / RDI 200B	
Lavatory adjacent to Store Room 1 in 75A Tan Kwai Tsuen Road, Casa Regalia 富豪·悦庭 丹桂村路75A號 儲存室1旁洗手間	Exhaust Fan 抽氣扇	Rosenberg 洛森 / RDI 200B	
Roof 天台	Gas Water Heater 煤氣熱水爐	TGC TNJW221TFQL	

The Vendor undertakes that if lifts or appliances of the specified brand name or model number are not installed in the Development, lifts or appliances of comparable quality will be installed.

賣方承諾如該發展項目中沒有安裝指明的品牌名稱或產品型號的升降機或設備，便會安裝品質相若的升降機或設備。

79A, 79B, 79C, 79D, 79E and 79F Tan Kwai Tsuen Road, Casa Regalia
富豪·悅庭丹桂村路79A、79B、79C、79D、79E、79F號

Location 位置	Appliance 設備	Brand 品牌 / Model Number 型號	
		Outdoor 室外機	Indoor 室內機
Living Room 客廳	VRV Multi Air-Conditioning System VRV分體式空調	Mcquay 麥克維爾 / MDS080BR5	Mcquay 麥克維爾 / MCC028TP
Dining Room 飯廳	VRV Multi Air-Conditioning System VRV分體式空調		Mcquay 麥克維爾 / MCC020TP
Master Bedroom 主人睡房	VRV Multi Air-Conditioning System VRV分體式空調		Mcquay 麥克維爾 / MWM015VP
Bedroom 1 睡房 1	VRV Multi Air-Conditioning System VRV分體式空調		Mcquay 麥克維爾 / MWM015VP
Bedroom 2 睡房 2	VRV Multi Air-Conditioning System VRV分體式空調		Mcquay 麥克維爾 / MWM015VP
Kitchen 廚房	Microwave Oven 微波爐	Bauknecht / EMCHT9145	
	Steamer 蒸爐	Bauknecht / ESTM9145	
	2 Burner Gas Hob 雙頭氣體煮食爐	Bauknecht / TGZ6260	
	Wok Burner 單頭氣體煮食爐	Bauknecht / TGC6180	
	Induction Hob 電磁爐	Bauknecht / ETI6260	
	Cookerhood 900mm 900毫米抽油煙機	Bauknecht / DWGR8410	
	Wine Cooler 酒櫃	Whirlpool / ARC1500	
	Refrigerator 雪櫃	Bauknecht / KSN1183	
	2 in 1 Washer dryer 洗衣乾衣機	Whirlpool / AWI 64120	
	11.6" Full HD LED TV 11.6吋LED高清電視	Cristal 尼斯 / CTV-121	
	Exhaust Fan 抽氣扇	Rosenberg 洛森 / RDI 200C	

Location 位置	Appliance 設備	Brand 品牌 / Model Number 型號
Master Bathroom 主人浴室	17.1" Waterproof TV 17.1吋防水電視	Cristal 尼斯 / BKW-171
	Exhaust Fan 抽氣扇	Rosenberg 洛森 / RDI 200C
Bathroom 1 浴室 1	Exhaust Fan 抽氣扇	Rosenberg 洛森 / RDI 200C
Bathroom 2 浴室 2	Exhaust Fan 抽氣扇	Rosenberg 洛森 / RDI 200C
Guest Lavatory 賓客洗手間	Exhaust Fan 抽氣扇	Rosenberg 洛森 / RDI 200B
Store Room 1 儲物室 1	Exhaust Fan 抽氣扇	Rosenberg 洛森 / RDI 200C
Store Room 2 儲物室 2	Exhaust Fan 抽氣扇	Rosenberg 洛森 / RDI 200B
Roof 天台	Gas Water Heater 煤氣熱水爐	TGC TNJW221TFQL

The Vendor undertakes that if lifts or appliances of the specified brand name or model number are not installed in the Development, lifts or appliances of comparable quality will be installed.

賣方承諾如該發展項目中沒有安裝指明的品牌名稱或產品型號的升降機或設備，便會安裝品質相若的升降機或設備。

FITTINGS, FINISHES AND APPLIANCES 裝置、裝修物料及設備

81 Tan Kwai Tsuen Road, Casa Regalia
富豪·悅庭丹桂村路81號

Location 位置	Appliance 設備	Brand 品牌 / Model Number 型號	
		Outdoor 室外機	Indoor 室內機
Living Room 客廳	VRV Multi Air-Conditioning System VRV分體式空調	Mcquay 麥克維爾 / MDS200BR5	Mcquay 麥克維爾 / MCC028TP
Dining Room 飯廳	VRV Multi Air-Conditioning System VRV分體式空調		Mcquay 麥克維爾 / MCC028TP
Master Bedroom 主人睡房	VRV Multi Air-Conditioning System VRV分體式空調		Mcquay 麥克維爾 / MWM015VP
Study Room 書房	VRV Multi Air-Conditioning System VRV分體式空調		Mcquay 麥克維爾 / MWM025VP
Lobby 大堂	VRV Multi Air-Conditioning System VRV分體式空調		Mcquay 麥克維爾 / MCC015TP
Bedroom 1 睡房 1	VRV Multi Air-Conditioning System VRV分體式空調		Mcquay 麥克維爾 / MWM015VP
Bedroom 2 睡房 2	VRV Multi Air-Conditioning System VRV分體式空調		Mcquay 麥克維爾 / MWM015VP
Bedroom 3 睡房 3	VRV Multi Air-Conditioning System VRV分體式空調		Mcquay 麥克維爾 / MWM015VP

Location 位置	Appliance 設備	Brand 品牌 / Model Number 型號
Kitchen 廚房	Microwave Oven 微波爐	Bauknecht / EMCHT9145
	Steamer 蒸爐	Bauknecht / ESTM9145
	2 Burner Gas Hob 雙頭氣體煮食爐	Bauknecht / TGZ6260
	Wok Burner 單頭氣體煮食爐	Bauknecht / TGC6180
	Induction Hob 電磁爐	Bauknecht / ETI6260
	Cookerhood 900mm 900毫米抽油煙機	Bauknecht / DWGR8410
	Wine Cooler 酒櫃	Whirlpool / ARC1500
	Refrigerator 雪櫃	Bauknecht / KSN1183
	2 in 1 Washer dryer 洗衣乾衣機	Whirlpool / AWI 64120
	11.6" Full HD LED TV 11.6吋LED高清電視	Cristal 尼斯 / CTV-121
Master Bathroom 主人浴室	Exhaust Fan 抽氣扇	Rosenberg 洛森 / RDI 200C
	17.1" Waterproof TV 17.1吋防水電視	Cristal 尼斯 / BKW-171
Bathroom 1 浴室 1	Exhaust Fan 抽氣扇	Rosenberg 洛森 / RDI 200C
Bathroom 2 浴室 2	Exhaust Fan 抽氣扇	Rosenberg 洛森 / RDI 200C
Bathroom 3 浴室 3	Exhaust Fan 抽氣扇	Rosenberg 洛森 / RDI 200C
Guest Lavatory 賓客洗手間	Exhaust Fan 抽氣扇	Rosenberg 洛森 / RDI 200C
B/F Lavatory 地庫洗手間	Exhaust Fan 抽氣扇	Rosenberg 洛森 / RDI 200C
Store Room 1 儲物室 1	Exhaust Fan 抽氣扇	Rosenberg 洛森 / RDI 200C
Store Room 2 儲物室 2	Exhaust Fan 抽氣扇	Rosenberg 洛森 / RDI 200B
Roof 天台	Gas Water Heater 煤氣熱水爐	TGC TNJW221TFQL

The Vendor undertakes that if lifts or appliances of the specified brand name or model number are not installed in the Development, lifts or appliances of comparable quality will be installed.

賣方承諾如該發展項目中沒有安裝指明的品牌名稱或產品型號的升降機或設備，便會安裝品質相若的升降機或設備。

83A, 83B, 83C, 83D, 83E, 83F and 83G Tan Kwai Tsuen Road, Casa Regalia
 富豪·悦庭丹桂村路83A、83B、83C、83D、83E、83F、83G號

Location 位置	Appliance 設備	Brand 品牌 / Model Number 型號	
		Outdoor 室外機	Indoor 室內機
Living Room 客廳	VRV Multi Air-Conditioning System VRV分體式空調	Mcquay 麥克維爾 / MDS120BR5	Mcquay 麥克維爾 / MCC028TP
Dining Room 飯廳	VRV Multi Air-Conditioning System VRV分體式空調		Mcquay 麥克維爾 / MCC018TP
Master Bedroom 1 主人睡房 1	VRV Multi Air-Conditioning System VRV分體式空調		Mcquay 麥克維爾 / MWM020VP
Master Bedroom 2 主人睡房 2	VRV Multi Air-Conditioning System VRV分體式空調		Mcquay 麥克維爾 / MWM020VP
Bedroom 1 睡房 1	VRV Multi Air-Conditioning System VRV分體式空調		Mcquay 麥克維爾 / MWM015VP
Bedroom 2 睡房 2	VRV Multi Air-Conditioning System VRV分體式空調		Mcquay 麥克維爾 / MWM015VP
Kitchen 廚房	Microwave Oven 微波爐	Bauknecht / EMCHT9145	
	Steamer 蒸爐	Bauknecht / ESTM9145	
	2 Burner Gas Hob 雙頭氣體煮食爐	Bauknecht / TGZ6260	
	Wok Burner 單頭氣體煮食爐	Bauknecht / TGC6180	
	Induction Hob 電磁爐	Bauknecht / ETI6260	
	Cookerhood 900mm 900毫米抽油煙機	Bauknecht / DWGR8410	
	Wine Cooler 酒櫃	Whirlpool / ARC1500	
	Refrigerator 雪櫃	Bauknecht / KSN1183	
	2 in 1 Washer dryer 洗衣乾衣機	Whirlpool / AWI 64120	
	11.6" Full HD LED TV 11.6吋LED高清電視	Cristal 尼斯 / CTV-121	
	Exhaust Fan 抽氣扇	Rosenberg 洛森 / RDI 200C	

Location 位置	Appliance 設備	Brand 品牌 / Model Number 型號	
		Outdoor 室外機	Indoor 室內機
Master Bathroom 1 主人浴室 1	17.1" Waterproof TV 17.1吋防水電視	Cristal 尼斯 / BKW-171	
	Exhaust Fan 抽氣扇	Rosenberg 洛森 / RDI 200C	
Master Bathroom 2 主人浴室 2	17.1" Waterproof TV 17.1吋防水電視	Cristal 尼斯 / BKW-171	
	Exhaust Fan 抽氣扇	Rosenberg 洛森 / RDI 200C	
Bathroom 1 浴室 1	Exhaust Fan 抽氣扇	Rosenberg 洛森 / RDI 200B	
Bathroom 2 浴室 2	Exhaust Fan 抽氣扇	Rosenberg 洛森 / RDI 200B	
Guest Lavatory 賓客洗手間	Exhaust Fan 抽氣扇	Rosenberg 洛森 / RDI 200B	
Store Room 1 儲物室 1	Exhaust Fan 抽氣扇	Rosenberg 洛森 / RDI 200C	
Store Room 2 in 83A, 83C, 83D, 83E, 83F and 83G Tan Kwai Tsuen Road, Casa Regalia 富豪·悦庭丹桂村路83A、83C、83D、83E、83F及83G號儲存室2	Exhaust Fan 抽氣扇	Rosenberg 洛森 / RDI 200B	
Lavatory adjacent to Store Room 1 in 83B Tan Kwai Tsuen Road, Casa Regalia 富豪·悦庭丹桂村路83B號儲存室1旁洗手間	Exhaust Fan 抽氣扇	Rosenberg 洛森 / RDI 200B	
Roof 天台	Gas Water Heater 煤氣熱水爐	TGC TNJW221TFQL	

The Vendor undertakes that if lifts or appliances of the specified brand name or model number are not installed in the Development, lifts or appliances of comparable quality will be installed.

賣方承諾如該發展項目中沒有安裝指明的品牌名稱或產品型號的升降機或設備，便會安裝品質相若的升降機或設備。

FITTINGS, FINISHES AND APPLIANCES 裝置、裝修物料及設備

85A, 85B, 85C and 85D Tan Kwai Tsuen Road, Casa Regalia
富豪·悅庭丹桂村路85A、85B、85C、85D號

Location 位置	Appliance 設備	Brand 品牌 / Model Number 型號	
		Outdoor 室外機	Indoor 室內機
Living Room 客廳	VRV Multi Air-Conditioning System VRV分體式空調	Mcquay 麥克維爾 / MDS080BR5	Mcquay 麥克維爾 / MCC028TP
Dining Room 飯廳	VRV Multi Air-Conditioning System VRV分體式空調		Mcquay 麥克維爾 / MCC018TP
Master Bedroom 主人睡房	VRV Multi Air-Conditioning System VRV分體式空調		Mcquay 麥克維爾 / MWM020VP
Bedroom 1 睡房 1	VRV Multi Air-Conditioning System VRV分體式空調		Mcquay 麥克維爾 / MWM020VP
Bedroom 2 睡房 2	VRV Multi Air-Conditioning System VRV分體式空調		Mcquay 麥克維爾 / MWM015VP
Kitchen 廚房	Microwave Oven 微波爐	Bauknecht / EMCHT9145	
	Steamer 蒸爐	Bauknecht / ESTM9145	
	2 Burner Gas Hob 雙頭氣體煮食爐	Bauknecht / TGZ6260	
	Wok Burner 單頭氣體煮食爐	Bauknecht / TGC6180	
	Induction Hob 電磁爐	Bauknecht / ETI6260	
	Cookerhood 900mm 900毫米抽油煙機	Bauknecht / DWGR8410	
	Wine Cooler 酒櫃	Whirlpool / ARC1500	
	Refrigerator 雪櫃	Bauknecht / KSN1183	
	2 in 1 Washer dryer 洗衣乾衣機	Whirlpool / AWI 64120	
	11.6" Full HD LED TV 11.6吋LED高清電視	Cristal 尼斯 / CTV-121	
Exhaust Fan 抽氣扇	Rosenberg 洛森 / RDI 200C		
Master Bathroom 主人浴室	17.1" Waterproof TV 17.1吋防水電視	Cristal 尼斯 / BKW-171	
	Exhaust Fan 抽氣扇	Rosenberg 洛森 / RDI 200C	
Bathroom 1 浴室 1	Exhaust Fan 抽氣扇	Rosenberg 洛森 / RDI 200C	
Bathroom 2 浴室 2	Exhaust Fan 抽氣扇	Rosenberg 洛森 / RDI 200C	
Guest Lavatory 賓客洗手間	Exhaust Fan 抽氣扇	Rosenberg 洛森 / RDI 200B	
Store Room 1 儲物室 1	Exhaust Fan 抽氣扇	Rosenberg 洛森 / RDI 200C	
Store Room 2 儲物室 2	Exhaust Fan 抽氣扇	Rosenberg 洛森 / RDI 200B	
Roof 天台	Gas Water Heater 煤氣熱水爐	TGC TNJW221TFQL	

87A, 87B, 87C and 87D Tan Kwai Tsuen Road, Casa Regalia
富豪·悅庭丹桂村路87A、87B、87C、87D號

Location 位置	Appliance 設備	Brand 品牌 / Model Number 型號	
		Outdoor 室外機	Indoor 室內機
Living Room 客廳	VRV Multi Air-Conditioning System VRV分體式空調	Mcquay 麥克維爾 / MDS080BR5	Mcquay 麥克維爾 / MCC028TP
Dining Room 飯廳	VRV Multi Air-Conditioning System VRV分體式空調		Mcquay 麥克維爾 / MCC020TP
Master Bedroom 主人睡房	VRV Multi Air-Conditioning System VRV分體式空調		Mcquay 麥克維爾 / MWM015VP
Bedroom 1 睡房 1	VRV Multi Air-Conditioning System VRV分體式空調		Mcquay 麥克維爾 / MWM015VP
Bedroom 2 睡房 2	VRV Multi Air-Conditioning System VRV分體式空調		Mcquay 麥克維爾 / MWM015VP
Kitchen 廚房	Microwave Oven 微波爐	Bauknecht / EMCHT9145	
	Steamer 蒸爐	Bauknecht / ESTM9145	
	2 Burner Gas Hob 雙頭氣體煮食爐	Bauknecht / TGZ6260	
	Wok Burner 單頭氣體煮食爐	Bauknecht / TGC6180	
	Induction Hob 電磁爐	Bauknecht / ETI6260	
	Cookerhood 900mm 900毫米抽油煙機	Bauknecht / DWGR8410	
	Wine Cooler 酒櫃	Whirlpool / ARC1500	
	Refrigerator 雪櫃	Bauknecht / KSN1183	
	2 in 1 Washer dryer 洗衣乾衣機	Whirlpool / AWI 64120	
	11.6" Full HD LED TV 11.6吋LED高清電視	Cristal 尼斯 / CTV-121	
Exhaust Fan 抽氣扇	Rosenberg 洛森 / RDI 200C		
Master Bathroom 主人浴室	17.1" Waterproof TV 17.1吋防水電視	Cristal 尼斯 / BKW-171	
	Exhaust Fan 抽氣扇	Rosenberg 洛森 / RDI 200C	
Bathroom 1 浴室 1	Exhaust Fan 抽氣扇	Rosenberg 洛森 / RDI 200C	
Bathroom 2 浴室 2	Exhaust Fan 抽氣扇	Rosenberg 洛森 / RDI 200C	
Guest Lavatory 賓客洗手間	Exhaust Fan 抽氣扇	Rosenberg 洛森 / RDI 200B	
Store Room 1 儲物室 1	Exhaust Fan 抽氣扇	Rosenberg 洛森 / RDI 200C	
Store Room 2 儲物室 2	Exhaust Fan 抽氣扇	Rosenberg 洛森 / RDI 200B	
Roof 天台	Gas Water Heater 煤氣熱水爐	TGC TNJW221TFQL	

The Vendor undertakes that if lifts or appliances of the specified brand name or model number are not installed in the Development, lifts or appliances of comparable quality will be installed.

賣方承諾如該發展項目中沒有安裝指明的品牌名稱或產品型號的升降機或設備，便會安裝品質相若的升降機或設備。

89 Tan Kwai Tsuen Road, Casa Regalia
富豪·悅庭丹桂村路89號

Location 位置	Appliance 設備	Brand 品牌 / Model Number 型號	
		Outdoor 室外機	Indoor 室內機
Living Room 客廳	VRV Multi Air-Conditioning System VRV分體式空調	Mcquay 麥克維爾 / MDS200BR5	Mcquay 麥克維爾 / MCC028TP
Dining Room 飯廳	VRV Multi Air-Conditioning System VRV分體式空調		Mcquay 麥克維爾 / MCC028TP
Master Bedroom 主人睡房	VRV Multi Air-Conditioning System VRV分體式空調		Mcquay 麥克維爾 / MWM020VP
Family Room 家庭休閒室	VRV Multi Air-Conditioning System VRV分體式空調		Mcquay 麥克維爾 / MCC015TP
Bedroom 1 睡房 1	VRV Multi Air-Conditioning System VRV分體式空調		Mcquay 麥克維爾 / MWM015VP
Bedroom 2 睡房 2	VRV Multi Air-Conditioning System VRV分體式空調		Mcquay 麥克維爾 / MWM015VP
Bedroom 3 睡房 3	VRV Multi Air-Conditioning System VRV分體式空調		Mcquay 麥克維爾 / MWM015VP
Bedroom 4 睡房 4	VRV Multi Air-Conditioning System VRV分體式空調		Mcquay 麥克維爾 / MWM015VP
Kitchen 廚房	Microwave Oven 微波爐		Bauknecht / EMCHT9145
	Steamer 蒸爐	Bauknecht / ESTM9145	
	2 Burner Gas Hob 雙頭氣體煮食爐	Bauknecht / TGZ6260	
	Wok Burner 單頭氣體煮食爐	Bauknecht / TGC6180	
	Induction Hob 電磁爐	Bauknecht / ETI6260	
	Cookerhood 900mm 900毫米抽油煙機	Bauknecht / DWGR8410	
	Wine Cooler 酒櫃	Whirlpool / ARC1500	
	Refrigerator 雪櫃	Bauknecht / KSN1183	
	2 in 1 Washer dryer 洗衣乾衣機	Whirlpool / AWI 64120	
	11.6" Full HD LED TV 11.6吋LED高清電視	Cristal 尼斯 / CTV-121	
Exhaust Fan 抽氣扇	Rosenberg 洛森 / RDI 200C		
Master Bathroom 主人浴室	17.1" Waterproof TV 17.1吋防水電視	Cristal 尼斯 / BKW-171	
	Exhaust Fan 抽氣扇	Rosenberg 洛森 / RDI 200C	

Location 位置	Appliance 設備	Brand 品牌 / Model Number 型號
Bathroom 1 浴室 1	Exhaust Fan 抽氣扇	Rosenberg 洛森 / RDI 200C
Bathroom 2 浴室 2	Exhaust Fan 抽氣扇	Rosenberg 洛森 / RDI 200C
Bathroom 3 浴室 3	Exhaust Fan 抽氣扇	Rosenberg 洛森 / RDI 200C
Bathroom 4 浴室 4	Exhaust Fan 抽氣扇	Rosenberg 洛森 / RDI 200C
Guest Lavatory 賓客洗手間	Exhaust Fan 抽氣扇	Rosenberg 洛森 / RDI 200C
B/F Lavatory 地庫洗手間	Exhaust Fan 抽氣扇	Rosenberg 洛森 / RDI 200C
Store Room 1 儲存室 1	Exhaust Fan 抽氣扇	Rosenberg 洛森 / RDI 200C
Store Room 2 儲物室 2	Exhaust Fan 抽氣扇	Rosenberg 洛森 / RDI 200B
Roof 天台	Gas Water Heater 煤氣熱水爐	TGC TNJW221TFQL

The Vendor undertakes that if lifts or appliances of the specified brand name or model number are not installed in the Development, lifts or appliances of comparable quality will be installed.

賣方承諾如該發展項目中沒有安裝指明的品牌名稱或產品型號的升降機或設備，便會安裝品質相若的升降機或設備。

FITTINGS, FINISHES AND APPLIANCES
裝置、裝修物料及設備

Schedule of Mechanical Electrical Provisions of Residential Units 住宅單位機電裝置數量說明表

Domus 尚築

Location 位置	Mechanical and Electrical Provisions 機電裝置	G/F 地下 All Flats Except Flat 3, 12, 15, 29 & 30 所有單位， 除單位3、12、15、29 及30外	G/F 地下 Flat 3 單位3	G/F 地下 Flat 12, 15, 29 & 30 單位12、15、29 及30	1/F -2/F 一樓至二樓 All Flats Except Flat 5, 15, 16, 30 & 31 所有單位， 除單位5、15、16、30 及31外	1/F -2/F 一樓至二樓 Flat 5 單位5	1/F -2/F 一樓至二樓 Flat 15, 16, 30 & 31 單位15、16、30 及31	3/F 三樓 All Flats Except Flat 5, 15, 16, 30 & 31 所有單位， 除單位5、15、16、30 及31外	3/F 三樓 Flat 5 單位5	3/F 三樓 Flat 30 單位30	3/F 三樓 Flat 15, 16 & 31 單位15、16 及31
Living /Dining Room 客飯廳	10A 1 Way 1 Gang SP Lighting Switch 10A一位一路燈掣	1	1	1	1	1	1	1	1	1	1
	10A 1 Way 2 Gang SP Lighting Switch 10A二位一路燈掣	1	1	1	1	1	1	1	1	1	1
	Switch for Exhaust Fan and Water Heater 抽風扇及電熱水爐	1	1	1	1	1	1	1	1	1	1
	13A Twin Socket Outlet 13A雙位電插座	2	2	2	2	2	2	2	2	2	2
	TV and FM Outlet 電視及電台天線插座	1	1	1	1	1	1	1	1	1	1
	Telephone Outlet 電話插座	1	1	1	1	1	1	1	1	1	1
	Door Bell 門鈴	1	1	1	1	1	1	1	1	1	1
	Doorphone Unit 門口對講機	1	1	1	1	1	1	1	1	1	1
	Door Bell Push Button 門鈴按鈕	1	1	1	1	1	1	1	1	1	1
	Downlight 天花燈	1	1	1	1	1	1	1	1	1	1
	Ceiling Light Point 天花燈位	1	2	1	1	2	1	1	2	1	1
	Fused Switch for Air-Conditioner 室內空調機接線位	1	1	1	1	1	1	1	1	1	1
Indoor Air-Conditioner 室內空調機	1	1	1	1	1	1	1	1	1	1	
Kitchen 廚房	13A Socket Outlet 13A單位電插座	4	4	4	4	4	4	4	4	4	4
	13A Twin Socket Outlet 13A雙位電插座	1	1	1	1	1	1	1	1	1	1
	Miniature Circuit Breaker Board 配電箱	1	1	1	1	1	1	1	1	1	1
	Washing Machine Connection Point (Water Inlet) 洗衣機接駁點(來水位)	1	1	1	1	1	1	1	1	1	1
	Washing Machine Connection Point (Water Outlet) 洗衣機接駁點(去水位)	1	1	1	1	1	1	1	1	1	1
	FS Smoke Detector 消防煙霧探測器	1	1	1	1	1	1	1	1	1	1
	FS Sprinkler Head 消防花灑頭	1	1	1	1	1	1	1	1	1	1

Domus 尚築

Location 位置	Mechanical and Electrical Provisions 機電裝置	G/F 地下 All Flats Except Flat 3, 12, 15, 29 & 30 所有單位， 除單位3、12、15、29 及30外	G/F 地下 Flat 3 單位3	G/F 地下 Flat 12, 15, 29 & 30 單位12、15、29 及30	1/F -2/F 一樓至二樓 All Flats Except Flat 5, 15, 16, 30 & 31 所有單位， 除單位5、15、16、30 及31外	1/F -2/F 一樓至二樓 Flat 5 單位5	1/F -2/F 一樓至二樓 Flat 15, 16, 30 & 31 單位15、16、30 及31	3/F 三樓 All Flats Except Flat 5, 15, 16, 30 & 31 所有單位， 除單位5、15、16、30 及31外	3/F 三樓 Flat 5 單位5	3/F 三樓 Flat 30 單位30	3/F 三樓 Flat 15, 16 & 31 單位15、16 及31
Bathroom 浴室	13A Socket Outlet 13A單位電插座	1	1	1	1	1	1	1	1	1	1
	Downlight 天花燈	3	3	2	3	3	2	3	3	3	2
	Water Heater 熱水爐	1	1	1	1	1	1	1	1	1	1
	Fused Switch for Exhaust Fan and Fresh Air Fan 抽氣扇及鮮風扇接線位	1	1	1	1	1	1	1	1	1	1
Bedroom 睡房	10A 1 Way 1 Gang SP Lighting Switch 10A一位一路燈掣	-	-	-	-	-	-	-	-	1	-
	13A Twin Socket Outlet 13A雙位電插座	-	-	-	-	-	-	-	-	3	-
	TV and FM Outlet 電視及電台天線插座	-	-	-	-	-	-	-	-	1	-
	Telephone Outlet 電話插座	-	-	-	-	-	-	-	-	1	-
	Ceiling Light Point 天花燈位	-	-	-	-	-	-	-	-	1	-
	Fused Switch for Air-Conditioner 室內空調機接線位	-	-	-	-	-	-	-	-	1	-
	Indoor Air-Conditioner 室內空調機	-	-	-	-	-	-	-	-	1	-
Balcony 露台	Balcony Light 露台照明燈	1	1	1	1	1	1	1	1	2	1
Garden 花園	Isolator for Outdoor Unit (Air Conditioner) 室外開關掣(空調機)	1	1	1	-	-	-	-	-	-	-
Flat Roof 天台	Isolator for Outdoor Unit (Air Conditioner) 室外開關掣(空調機)	-	-	-	1	1	1	1	1	2	1

Casa Regalia 富豪·悦庭

Floor 樓層	Location 位置	Mechanical and Electrical Provisions 機電裝置	67A Tan Kwai Tsuen Road, Casa Regalia 富豪·悦庭丹桂村路 67A號	67B & 69A Tan Kwai Tsuen Road, Casa Regalia 富豪·悦庭丹桂村路 67B及69A號	69B Tan Kwai Tsuen Road, Casa Regalia 富豪·悦庭丹桂村路 69B號	71A Tan Kwai Tsuen Road, Casa Regalia 富豪·悦庭丹桂村路 71A號	71B Tan Kwai Tsuen Road, Casa Regalia 富豪·悦庭丹桂村路 71B號	73A & 73B Tan Kwai Tsuen Road, Casa Regalia 富豪·悦庭丹桂村路 73A及73B號
B/F 地庫	Store Room 1 儲物室 1	2 Gang Double Pole Switch for Exhaust Fan 抽氣扇雙開關	1	1	1	1	1	1
		Switch for Exhaust Fan 抽氣扇開關	1	1	1	1	1	1
		13A Socket Outlet 13A單位電插座	2	2	2	1	2	2
		Door Bell 門鈴	1	1	1	1	1	1
		10A 1 Way 2 Gang SP Lighting Switch 10A二位一路燈掣	1	1	1	-	1	1
		Ceiling Light Point 天花燈位	1	1	1	-	1	1
		Downlight 天花燈	-	-	-	1	-	-
		Fused Switch for Exhaust Fan and Fresh Air Fan 抽氣扇及鮮風扇接線位	3	3	3	3	3	3
	Store Room 2 儲物室 2	Ceiling Light Point 天花燈位	1	1	1	-	1	1
	Lavatory adjacent to Store Room 1 儲物室一傍之洗手間	Ceiling Light Point 天花燈位	-	-	-	1	-	-
	Corridor 走廊	10A 1 Way 1 Gang SP Lighting Switch 10A一位一路燈掣	2	2	2	2	2	2
		Switch for Exhaust Fan 抽氣扇開關	1	1	1	1	1	1
		10A 2 Way 1 Gang SP Lighting Switch 10A一位二路燈掣	1	1	1	1	1	1
		Door Bell Push Button 門鈴按鈕	1	1	1	1	1	1
		Downlight 天花燈	2	2	2	2	2	2
		Ceiling Light Point 天花燈位	-	-	-	-	-	-
	Car Park 車庫	Miniature Circuit Breaker Board 配電箱	1	1	1	1	1	1
		Downlight 天花燈	2	2	2	2	2	2
		13A Socket Outlet 電動車13A電插座	2	2	2	2	2	2
	Fire Service Pump Room 消防泵房	13A Watertight Socket Outlet 13A防水電插座	1	1	1	1	1	1
Fused Switch for Exhaust Fan and Fresh Air Fan 抽氣扇及鮮風扇接線位		1	1	1	1	1	1	
Fluorescent Light 日光燈		1	1	1	1	1	1	

Casa Regalia 富豪·悦庭

Floor 樓層	Location 位置	Mechanical and Electrical Provisions 機電裝置	67A Tan Kwai Tsuen Road, Casa Regalia 富豪·悦庭丹桂村路 67A號	67B & 69A Tan Kwai Tsuen Road, Casa Regalia 富豪·悦庭丹桂村路 67B及69A號	69B Tan Kwai Tsuen Road, Casa Regalia 富豪·悦庭丹桂村路 69B號	71A Tan Kwai Tsuen Road, Casa Regalia 富豪·悦庭丹桂村路 71A號	71B Tan Kwai Tsuen Road, Casa Regalia 富豪·悦庭丹桂村路 71B號	73A & 73B Tan Kwai Tsuen Road, Casa Regalia 富豪·悦庭丹桂村路 73A及73B號
G/F 地下	Living / Dining Room 客飯廳	Switch for Exhaust Fan 抽氣扇開關	2	2	2	2	2	2
		13A Twin Socket Outlet 13A雙位電插座	5	5	5	4	5	5
		TV and FM Outlet 電視及電台天線插座	3	3	3	3	3	3
		Telephone Outlet 電話插座	2	2	2	3	3	3
		10A 1 Way 1 Gang SP Lighting Switch 10A一位一路燈掣	2	1	1	1	1	1
		10A 1 Way 2 Gang SP Lighting Switch 10A二位一路燈掣	2	3	3	4	3	3
		10A 1 Way 3 Gang SP Lighting Switch 10A三位一路燈掣	1	1	1	-	1	1
		10A 1 Way 4 Gang SP Lighting Switch 10A四位一路燈掣	-	-	-	1	-	-
		10A 2 Way 1 Gang SP Lighting Switch 10A一位二路燈掣	-	-	-	2	-	-
		10A 2 Way 2 Gang SP Lighting Switch 10A二位二路燈掣	-	-	-	1	-	-
		10A 2 Way 4 Gang SP Lighting Switch 10A四位二路燈掣	-	-	-	1	-	-
		Video Doorphone 視像門口對講機	1	1	1	1	1	1
		Downlight 天花燈	5	5	5	30	6	6
		Ceiling Light Point 天花燈位	1	1	1	1	-	-
		Fused Switch for Air-Conditioner 室內空調機接線位	2	2	2	2	2	2
		Concealed Type AC Indoor Unit 隱藏室內空調機	2	2	2	2	2	2
	Kitchen 廚房	13A Socket Outlet 13A單位電插座	7	7	7	7	7	7
		13A Twin Socket Outlet 13A雙位電插座	2	2	2	2	2	2
		TV and FM Outlet 電視及電台天線插座	1	1	1	1	1	1
		Door Bell 門鈴	1	1	1	1	1	1
		Downlight 天花燈	10	10	10	10	10	10
		Washing Machine Connection Point (Water Inlet) 洗衣機接駁點(來水位)	1	1	1	1	1	1
		Washing Machine Connection Point (Water Outlet) 洗衣機接駁點(去水位)	1	1	1	1	1	1
		Gas Meter 煤氣計量錶	1	1	1	1	1	1

Casa Regalia 富豪·悦庭

Floor 樓層	Location 位置	Mechanical and Electrical Provisions 機電裝置	67A Tan Kwai Tsuen Road, Casa Regalia 富豪·悦庭丹桂村路 67A號	67B & 69A Tan Kwai Tsuen Road, Casa Regalia 富豪·悦庭丹桂村路 67B及69A號	69B Tan Kwai Tsuen Road, Casa Regalia 富豪·悦庭丹桂村路 69B號	71A Tan Kwai Tsuen Road, Casa Regalia 富豪·悦庭丹桂村路 71A號	71B Tan Kwai Tsuen Road, Casa Regalia 富豪·悦庭丹桂村路 71B號	73A & 73B Tan Kwai Tsuen Road, Casa Regalia 富豪·悦庭丹桂村路 73A及73B號
G/F 地下	Guest Lavatory 客人洗手間	Downlight 天花燈	2	2	2	2	2	2
	Garden 花園	Video Doorphone Panel 大門入口視像對講機	1	1	1	1	1	1
		13A Watertight Socket Outlet 13A防水電插座	2	2	2	2	2	2
		Outdoor Wall Mount Light 戶外掛牆照明燈	1	3	3	3	3	3
		Outdoor Planter Light 戶外植物照明燈	-	-	-	6	-	-
		Outdoor Foot Light 戶外牆身照明燈	4	4	4	4	4	4
1/F 一樓	Master Bedroom 1 主人睡房 1	10A 1 Way 1 Gang SP Lighting Switch 10A一位一路燈掣	2	2	2	1	2	2
		10A 1 Way 2 Gang SP Lighting Switch 10A二位一路燈掣	1	1	1	2	1	1
		10A 1 Way 4 Gang SP Lighting Switch 10A四位一路燈掣	-	-	-	1	-	-
		10A 2 Way 2 Gang SP Lighting Switch 10A二位二路燈掣	-	-	-	1	-	-
		10A 2 Way 4 Gang SP Lighting Switch 10A四位二路燈掣	-	-	-	1	-	-
		Switch for Exhaust Fan 抽氣扇開關	-	-	-	1	-	-
		2 Gang Double Pole Switch for Exhaust Fan and Heat Lamp 抽氣扇及暖燈雙開關	1	1	1	-	1	1
		13A Twin Socket Outlet 13A雙位電插座	3	3	3	4	3	3
		TV and FM Outlet 電視及電台天線插座	1	1	1	1	1	1
		Telephone Outlet 電話插座	1	1	1	1	1	1
		Downlight 天花燈	1	1	1	-	-	-
		Ceiling Light Point 天花燈位	1	1	1	-	1	1
	Fused Switch for Air-Conditioner 室內空調機接線位	1	1	1	1	1	1	
	Indoor Air-Conditioner 室內空調機	1	1	1	1	1	1	
	Bedroom 1 睡房 1	10A 1 Way 1 Gang SP Lighting Switch 10A一位一路燈掣	2	2	2	-	1	1
10A 1 Way 2 Gang SP Lighting Switch 10A二位一路燈掣		1	1	1	2	1	1	
10A 2 Way 4 Gang SP Lighting Switch 10A四位二路燈掣		-	-	-	2	-	-	

Casa Regalia 富豪·悦庭

Floor 樓層	Location 位置	Mechanical and Electrical Provisions 機電裝置	67A Tan Kwai Tsuen Road, Casa Regalia 富豪·悦庭丹桂村路 67A號	67B & 69A Tan Kwai Tsuen Road, Casa Regalia 富豪·悦庭丹桂村路 67B及69A號	69B Tan Kwai Tsuen Road, Casa Regalia 富豪·悦庭丹桂村路 69B號	71A Tan Kwai Tsuen Road, Casa Regalia 富豪·悦庭丹桂村路 71A號	71B Tan Kwai Tsuen Road, Casa Regalia 富豪·悦庭丹桂村路 71B號	73A & 73B Tan Kwai Tsuen Road, Casa Regalia 富豪·悦庭丹桂村路 73A及73B號	
1/F 一樓	Bedroom 1 睡房 1	Switch for Exhaust Fan 抽氣扇開關	1	1	1	1	1	1	
		13A Twin Socket Outlet 13A雙位電插座	3	3	3	4	3	3	
		TV and FM Outlet 電視及電台天線插座	1	1	1	1	1	1	
		Telephone Outlet 電話插座	1	1	1	1	1	1	
		Downlight 天花燈	1	1	1	1	1	1	
		Ceiling Light Point 天花燈位	1	1	1	-	1	1	
		Fused Switch for Air-Conditioner 室內空調機接線位	1	1	1	1	1	1	
		Indoor Air-Conditioner 室內空調機	1	1	1	1	1	1	
	Master Bathroom 1 主人房浴室 1	13A Socket Outlet 13A單位電插座	3	3	3	2	3	3	
		TV and FM Outlet 電視及電台天線插座	1	1	1	1	1	1	
		Gas Water Heater Controller 煤氣熱水爐溫度控制	1	1	1	1	1	1	
		Heat Lamp 天花暖燈	1	1	1	-	1	1	
		Downlight 天花燈	5	5	5	5	5	5	
	Bathroom 1 浴室 1	13A Socket Outlet 13A單位電插座	2	2	2	1	2	2	
		Downlight 天花燈	3	3	3	3	3	3	
	Flat Roof for Master Bedroom 主人睡房平台	Flat Roof Light 平台照明燈	1	1	1	2	1	1	
	Flat Roof for Bedroom 1 睡房1平台	Outdoor Wall Mount Light 戶外掛牆照明燈	1	1	1	-	-	-	
	2/F 二樓	Master Bedroom 2 主人睡房 2	10A 1 Way 1 Gang SP Lighting Switch 10A單位燈掣	2	2	2	1	2	2
			10A 1 Way 2 Gang SP Lighting Switch 10A二位一路燈掣	1	1	1	3	1	1
			10A 2 Way 2 Gang SP Lighting Switch 10A二位二路燈掣	-	-	-	2	-	-
Switch for Exhaust Fan 抽氣扇開關			-	-	-	1	-	-	
2 Gang Double Pole Switch for Exhaust Fan and Heat Lamp 抽氣扇及暖燈雙開關			1	1	1	-	1	1	
13A Twin Socket Outlet 13A雙位電插座			3	3	3	4	3	3	

Casa Regalia 富豪·悦庭

Floor 樓層	Location 位置	Mechanical and Electrical Provisions 機電裝置	67A Tan Kwai Tsuen Road, Casa Regalia 富豪·悦庭丹桂村路 67A號	67B & 69A Tan Kwai Tsuen Road, Casa Regalia 富豪·悦庭丹桂村路 67B及69A號	69B Tan Kwai Tsuen Road, Casa Regalia 富豪·悦庭丹桂村路 69B號	71A Tan Kwai Tsuen Road, Casa Regalia 富豪·悦庭丹桂村路 71A號	71B Tan Kwai Tsuen Road, Casa Regalia 富豪·悦庭丹桂村路 71B號	73A & 73B Tan Kwai Tsuen Road, Casa Regalia 富豪·悦庭丹桂村路 73A及73B號
2/F 二樓	Master Bedroom 2 主人睡房 2	TV and FM Outlet 電視及電台天線插座	1	1	1	1	1	1
		Telephone Outlet 電話插座	1	1	1	1	1	1
		Downlight 天花燈	1	1	1	-	-	-
		Ceiling Light Point 天花燈位	1	1	1	-	1	1
		Fused Switch for Air-Conditioner 室內空調機接線位	1	1	1	1	1	1
		Indoor Air-Conditioner 室內空調機	1	1	1	1	1	1
	Bedroom 2 睡房 2	10A 1 Way 1 Gang SP Lighting Switch 10A一位一路燈掣	1	1	1	-	1	1
		10A 1 Way 2 Gang SP Lighting Switch 10A二位一路燈掣	1	1	1	3	1	1
		Switch for Exhaust Fan 抽氣扇開關	1	1	1	1	1	1
		13A Socket Outlet 13A單位電插座	-	-	-	1	-	-
		13A Twin Socket Outlet 13A雙位電插座	3	3	3	3	3	3
		TV and FM Outlet 電視及電台天線插座	1	1	1	1	1	1
		Telephone Outlet 電話插座	1	1	1	1	1	1
		Downlight 天花燈	1	1	1	1	1	1
		Ceiling Light Point 天花燈位	1	1	1	-	1	1
		Fused Switch for Air-Conditioner 室內空調機接線位	1	1	1	1	1	1
	Indoor Air-Conditioner 室內空調機	1	1	1	1	1	1	
	Master Bathroom 2 主人房浴室 2	13A Socket Outlet 13A單位電插座	3	3	3	2	3	3
		TV and FM Outlet 電視及電台天線插座	1	1	1	1	1	1
		Gas Water Heater Controller 煤氣熱水爐溫度控制	1	1	1	1	1	1
Heat Lamp 天花暖燈		1	1	1	-	1	1	
Downlight 天花燈		5	5	5	5	5	5	

Casa Regalia 富豪·悦庭

Floor 樓層	Location 位置	Mechanical and Electrical Provisions 機電裝置	67A Tan Kwai Tsuen Road, Casa Regalia 富豪·悦庭丹桂村路 67A號	67B & 69A Tan Kwai Tsuen Road, Casa Regalia 富豪·悦庭丹桂村路 67B及69A號	69B Tan Kwai Tsuen Road, Casa Regalia 富豪·悦庭丹桂村路 69B號	71A Tan Kwai Tsuen Road, Casa Regalia 富豪·悦庭丹桂村路 71A號	71B Tan Kwai Tsuen Road, Casa Regalia 富豪·悦庭丹桂村路 71B號	73A & 73B Tan Kwai Tsuen Road, Casa Regalia 富豪·悦庭丹桂村路 73A及73B號
2/F 二樓	Bathroom 2 浴室 2	13A Socket Outlet 13A單位電插座	2	2	2	1	2	2
		Downlight 天花燈	3	3	3	3	3	3
	Balcony for Master Bedroom 2 主人睡房2露台	Balcony Light 露台照明燈	1	1	1	2	1	1
B/F - Roof 地庫至 天台	Internal Staircase and Landings 室內樓梯及通道	10A 1 Way 1 Gang SP Lighting Switch 10A一位一路燈掣	1	1	1	2	1	1
		10A 1 Way 2 Gang SP Lighting Switch 10A二位一路燈掣	-	-	-	1	-	-
		10A 1 Way 3 Gang SP Lighting Switch 10A三位一路燈掣	-	-	-	1	-	-
		10A 2 Way 1 Gang SP Lighting Switch 10A一位二路燈掣	4	4	4	3	4	4
		10A 2 Way 2 Gang SP Lighting Switch 10A二位二路燈掣	-	-	-	1	-	-
		10A 2 Way 3 Gang SP Lighting Switch 10A三位二路燈掣	-	-	-	1	-	-
		Door Bell 門鈴	3	3	3	3	3	3
		13A Socket Outlet 13A單位電插座	-	-	-	2	-	-
		Indoor Wall Mount Light 室內掛牆照明燈	1	1	1	1	1	1
		Downlight 天花燈	-	-	-	24	2	2
		Ceiling Light Point 天花燈位	8	8	8	4	8	8
Indoor Air-Conditioner 室內空調機	-	-	-	-	1	-		
Roof 天台		Isolator for Outdoor Unit (Air Conditioner) 室外開關掣(空調機)	1	1	1	1	2	1
		Outdoor Foot Light 戶外牆身照明燈	3	3	3	3	3	3
		13A Watertight Socket Outlet 13A防水電插座	3	1	1	1	1	1
		Water Heater 熱水爐	2	2	2	2	2	2
		Outdoor Air-Conditioner 室外空調機	1	1	1	1	2	1

Casa Regalia 富豪·悦庭

Floor 樓層	Location 位置	Mechanical and Electrical Provisions 機電裝置	83A Tan Kwai Tsuen Road, Casa Regalia 富豪·悦庭丹桂村路83A號	83B Tan Kwai Tsuen Road, Casa Regalia 富豪·悦庭丹桂村路83B號	83C Tan Kwai Tsuen Road, Casa Regalia 富豪·悦庭丹桂村路83C號	83D, 83E, 83F & 83G Tan Kwai Tsuen Road, Casa Regalia 富豪·悦庭丹桂村路 83D、83E、83F及83G號
B/F 地庫	Store Room 1 儲物室 1	Switch for Exhaust Fan 抽氣扇開關	2	2	2	2
		13A Socket Outlet 13A單位電插座	2	1	2	2
		Door Bell 門鈴	1	1	1	1
		10A 1 Way 2 Gang SP Lighting Switch 10A二位一路燈掣	1	1	1	1
		Ceiling Light Point 天花燈位	1	1	1	1
		Fused Switch for Exhaust Fan and Fresh Air Fan 抽氣扇及鮮風扇接線位	3	3	3	3
	Store Room 2 儲物室 2	Ceiling Light Point 天花燈位	1	-	1	1
	Lavatory adjacent to Store Room 儲物室一傍之洗手間	Ceiling Light Point 天花燈位	-	1	-	-
	Corridor 走廊	10A 1 Way 1 Gang SP Lighting Switch 10A一位一路燈掣	2	2	2	2
		Switch for Exhaust Fan 抽氣扇開關	1	1	1	1
		10A 2 Way 1 Gang SP Lighting Switch 10A一位二路燈掣	1	1	1	1
		Door Bell Push Button 門鈴按鈕	1	1	1	1
		Downlight 天花燈	2	2	2	2
		Ceiling Light Point 天花燈位	-	-	-	-
	Car Park 車庫	Miniature Circuit Breaker Board 配電箱	1	1	1	1
		Downlight 天花燈	2	2	2	2
		13A Socket Outlet 電動車13A電插座	2	2	2	2
	Fire Service Pump Room 消防泵房	13A Watertight Socket Outlet 13A防水電插座	1	1	1	1
		Fused Switch for Exhaust Fan and Fresh Air Fan 抽氣扇及鮮風扇接線位	1	1	1	1
		Fluorescent Light 日光燈	1	1	1	1

Casa Regalia 富豪·悦庭

Floor 樓層	Location 位置	Mechanical and Electrical Provisions 機電裝置	83A Tan Kwai Tsuen Road, Casa Regalia 富豪·悦庭丹桂村路83A號	83B Tan Kwai Tsuen Road, Casa Regalia 富豪·悦庭丹桂村路83B號	83C Tan Kwai Tsuen Road, Casa Regalia 富豪·悦庭丹桂村路83C號	83D, 83E, 83F & 83G Tan Kwai Tsuen Road, Casa Regalia 富豪·悦庭丹桂村路 83D、83E、83F及83G號
G/F 地下	Living / Dining Room 客飯廳	10A 1 Way 1 Gang SP Lighting Switch 10A一位一路燈掣	2	1	2	2
		10A 1 Way 2 Gang SP Lighting Switch 10A二位一路燈掣	2	3	2	2
		10A 1 Way 3 Gang SP Lighting Switch 10A三位一路燈掣	1	-	1	1
		10A 2 Way 2 Gang SP Lighting Switch 10A二位二路燈掣	-	2	-	-
		10A 2 Way 4 Gang SP Lighting Switch 10A四位二路燈掣	-	4	-	-
		Switch for Exhaust Fan 抽氣扇開關	2	2	2	2
		13A Socket Outlet 13A單位電插座	-	4	-	-
		13A Twin Socket Outlet 13A雙位電插座	5	5	5	5
		TV and FM Outlet 電視及電台天線插座	3	2	3	3
		Telephone Outlet 電話插座	3	3	3	3
		Video Doorphone 視像門口對講機	1	1	1	1
		Downlight 天花燈	6	25	6	6
		Ceiling Light Point 天花燈位	1	1	1	1
		Fused Switch for Air-Conditioner 室內空調機接線位	2	2	2	2
	Concealed Type AC Indoor Unit 隱藏室內空調機	2	2	2	2	
	Kitchen 廚房	13A Socket Outlet 13A單位電插座	7	7	7	7
		13A Twin Socket Outlet 13A雙位電插座	2	2	2	2
		TV and FM Outlet 電視及電台天線插座	1	1	1	1
		Door Bell 門鈴	1	1	1	1
		Downlight 天花燈	9	9	9	9
		Washing Machine Connection Point (Water Inlet) 洗衣機接駁點(來水位)	1	1	1	1
Washing Machine Connection Point (Water Outlet) 洗衣機接駁點(去水位)		1	1	1	1	
Gas Meter 煤氣計量錶	1	1	1	1		

Casa Regalia 富豪·悦庭

Floor 樓層	Location 位置	Mechanical and Electrical Provisions 機電裝置	83A Tan Kwai Tsuen Road, Casa Regalia 富豪·悦庭丹桂村路83A號	83B Tan Kwai Tsuen Road, Casa Regalia 富豪·悦庭丹桂村路83B號	83C Tan Kwai Tsuen Road, Casa Regalia 富豪·悦庭丹桂村路83C號	83D, 83E, 83F & 83G Tan Kwai Tsuen Road, Casa Regalia 富豪·悦庭丹桂村路 83D、83E、83F及83G號
G/F 地下	Guest Lavatory 客人洗手間	Downlight 天花燈	2	2	2	2
		13A Socket Outlet 13A單位電插座	-	1	-	-
	Garden 花園	Video Doorphone Panel 大門入口視像對講機	1	1	1	1
		Outdoor Wall Mount Light 戶外掛牆照明燈	7	4	4	4
		13A Watertight Socket Outlet 13A防水電插座	2	2	2	2
		Outdoor Planter Light 戶外植物照明燈	-	7	-	-
	Outdoor Foot Light 戶外牆身照明燈	2	2	2	2	
1/F 一樓	Master Bedroom 1 主人睡房 1	10A 1 Way 1 Gang SP Lighting Switch 10A一位一路燈掣	2	-	2	2
		10A 1 Way 2 Gang SP Lighting Switch 10A二位一路燈掣	1	-	1	1
		10A 1 Way 4 Gang SP Lighting Switch 10A四位一路燈掣	-	1	-	-
		10A 2 Way 2 Gang SP Lighting Switch 10A二位二路燈掣	-	1	-	-
		10A 2 Way 4 Gang SP Lighting Switch 10A四位二路燈掣	-	1	-	-
		2 Gang Double Pole Switch for Exhaust Fan and Heat Lamp 抽氣扇及暖燈雙開關	1	-	1	1
		Switch for Exhaust Fan 抽氣扇開關	-	1	-	-
		13A Socket Outlet 13A單位電插座	-	3	-	-
		13A Twin Socket Outlet 13A雙位電插座	3	2	3	3
		TV and FM Outlet 電視及電台天線插座	1	1	1	1
		Telephone Outlet 電話插座	1	2	1	1
		Downlight 天花燈	-	6	-	-
		Ceiling Light Point 天花燈位	1	-	1	1
		Fused Switch for Air-Conditioner 室內空調機接線位	1	1	1	1
Indoor Air-Conditioner 室內空調機	1	1	1	1		

Casa Regalia 富豪·悦庭

Floor 樓層	Location 位置	Mechanical and Electrical Provisions 機電裝置	83A Tan Kwai Tsuen Road, Casa Regalia 富豪·悦庭丹桂村路83A號	83B Tan Kwai Tsuen Road, Casa Regalia 富豪·悦庭丹桂村路83B號	83C Tan Kwai Tsuen Road, Casa Regalia 富豪·悦庭丹桂村路83C號	83D, 83E, 83F & 83G Tan Kwai Tsuen Road, Casa Regalia 富豪·悦庭丹桂村路 83D、83E、83F及83G號
1/F 一樓	Bedroom 1 睡房 1	10A 1 Way 1 Gang SP Lighting Switch 10A單位燈掣	1	1	1	1
		10A 1 Way 2 Gang SP Lighting Switch 10A二位一路燈掣	1	-	1	1
		10A 1 Way 4 Gang SP Lighting Switch 10A四位一路燈掣	-	2	-	-
		Switch for Exhaust Fan 抽氣扇開關	1	1	1	1
		13A Twin Socket Outlet 13A雙位電插座	3	3	3	3
		TV and FM Outlet 電視及電台天線插座	1	1	1	1
		Telephone Outlet 電話插座	1	1	1	1
		Downlight 天花燈	1	5	1	1
		Ceiling Light Point 天花燈位	1	-	1	1
		Fused Switch for Air-Conditioner 室內空調機接線位	1	1	1	1
	Indoor Air-Conditioner 室內空調機	1	1	1	1	
	Master Bathroom 1 主人房浴室 1	13A Socket Outlet 13A單位電插座	3	2	3	3
		TV and FM Outlet 電視及電台天線插座	1	1	1	1
		Gas Water Heater Controller 煤氣熱水爐溫度控制	1	1	1	1
		Heat Lamp 天花暖燈	1	-	1	1
		Downlight 天花燈	6	5	6	6
	Bathroom 1 浴室 1	13A Socket Outlet 13A單位電插座	2	1	2	2
		Downlight 天花燈	3	3	3	3
	Flat Roof for Master Bedroom 1 主人睡房1平台	Balcony Light 露台照明燈	1	3	1	1

Casa Regalia 富豪·悦庭

Floor 樓層	Location 位置	Mechanical and Electrical Provisions 機電裝置	83A Tan Kwai Tsuen Road, Casa Regalia 富豪·悦庭丹桂村路83A號	83B Tan Kwai Tsuen Road, Casa Regalia 富豪·悦庭丹桂村路83B號	83C Tan Kwai Tsuen Road, Casa Regalia 富豪·悦庭丹桂村路83C號	83D, 83E, 83F & 83G Tan Kwai Tsuen Road, Casa Regalia 富豪·悦庭丹桂村路 83D、83E、83F及83G號
2/F 二樓	Master Bedroom 2 主人睡房 2	10A 1 Way 1 Gang SP Lighting Switch 10A一位一路燈掣	2	1	2	2
		10A 1 Way 2 Gang SP Lighting Switch 10A二位一路燈掣	1	3	1	1
		10A 2 Way 2 Gang SP Lighting Switch 10A二位二路燈掣	-	2	-	-
		Switch for Exhaust Fan 抽氣扇開關	-	1	-	-
		2 Gang Double Pole Switch for Exhaust Fan, Water Heater and Heat Lamp 抽氣扇、電熱水爐及暖燈雙開關	1	-	1	1
		13A Socket Outlet 13A單位電插座	-	4	-	-
		13A Twin Socket Outlet 13A雙位電插座	3	1	3	3
		TV and FM Outlet 電視及電台天線插座	1	1	1	1
		Telephone Outlet 電話插座	1	2	1	1
		Ceiling Light Point 天花燈位	1	-	1	1
		Fused Switch for Air-Conditioner 室內空調機接駁位	1	1	1	1
		Downlight 天花燈	-	6	-	-
		Indoor Air-Conditioner 室內空調機	1	1	1	1
	Bedroom 2 睡房 2	10A 1 Way 1 Gang SP Lighting Switch 10A一位一路燈掣	1	-	1	1
		10A 1 Way 2 Gang SP Lighting Switch 10A二位一路燈掣	1	-	1	1
		10A 1 Way 4 Gang SP Lighting Switch 10A四位一路燈掣	-	2	-	-
		Switch for Exhaust Fan 抽氣扇開關	1	1	1	1
		13A Socket Outlet 13A單位電插座	-	3	-	-
		13A Twin Socket Outlet 13A雙位電插座	4	2	4	3
		TV and FM Outlet 電視及電台天線插座	1	1	1	1
		Telephone Outlet 電話插座	1	2	1	1
		Downlight 天花燈	1	7	1	1
		Ceiling Light Point 天花燈位	1	-	1	1
		Fused Switch for Air-Conditioner 室內空調機接線位	1	1	1	1
Indoor Air-Conditioner 室內空調機	1	1	1	1		

Casa Regalia 富豪·悦庭

Floor 樓層	Location 位置	Mechanical and Electrical Provisions 機電裝置	83A Tan Kwai Tsuen Road, Casa Regalia 富豪·悦庭丹桂村路83A號	83B Tan Kwai Tsuen Road, Casa Regalia 富豪·悦庭丹桂村路83B號	83C Tan Kwai Tsuen Road, Casa Regalia 富豪·悦庭丹桂村路83C號	83D, 83E, 83F & 83G Tan Kwai Tsuen Road, Casa Regalia 富豪·悦庭丹桂村路 83D、83E、83F及83G號
2/F 二樓	Master Bathroom 2 主人房浴室 2	13A Socket Outlet 13A單位電插座	3	2	3	3
		TV and FM Outlet 電視及電台天線插座	1	1	1	1
		Gas Water Heater Controller 煤氣熱水爐溫度控制	1	1	1	1
		Heat Lamp 天花暖燈	1	-	1	1
		Downlight 天花燈	6	4	6	6
	Bathroom 2 浴室 2	13A Socket Outlet 13A單位電插座	2	1	2	2
		Downlight 天花燈	3	3	3	3
	Balcony for Master Bedroom 2 主人睡房2露台	Balcony Light 露台照明燈	1	2	1	1
	B/F - Roof 地庫至天台	Internal Staircase and Landings 室內樓梯及通道	10A 1 Way 1 Gang SP Lighting Switch 10A一位一路燈掣	1	1	1
10A 2 Way 1 Gang SP Lighting Switch 10A一位二路燈掣			4	7	4	4
10A 2 Way 2 Gang SP Lighting Switch 10A二位二路燈掣			-	1	-	-
13A Socket Outlet 13A單位電插座			-	2	-	-
Door Bell 門鈴			3	3	3	3
Indoor Wall Mount Light 室內掛牆照明燈			2	1	2	2
Downlight 天花燈			-	18	-	-
Ceiling Light Point 天花燈位			6	-	6	6
Roof 天台		Isolator for Outdoor Unit (Air Conditioner) 室外開關掣(空調機)	1	1	1	1
		13A Watertight Socket Outlet 13A防水電插座	2	2	2	2
		Outdoor Foot Light 戶外牆身照明燈	3	3	3	3
		Water Heater 熱水爐	2	2	2	2
		Outdoor Air-Conditioner 室外空調機	1	1	1	1

Casa Regalia 富豪·悦庭

Floor 樓層	Location 位置	Mechanical and Electrical Provisions 機電裝置	75A Tan Kwai Tsuen Road, Casa Regalia 富豪·悦庭丹桂村路75A號	75B Tan Kwai Tsuen Road, Casa Regalia 富豪·悦庭丹桂村路75B號	77A & 77B Tan Kwai Tsuen Road, Casa Regalia 富豪·悦庭丹桂村路 77A及77B號	85A, 85B, 85C & 85D Tan Kwai Tsuen Road, Casa Regalia 富豪·悦庭丹桂村路 85A、85B、85C及85D號
B/F 地庫	Store Room 1 儲物室 1	Switch for Exhaust Fan 抽氣扇開關	2	2	2	2
		13A Socket Outlet 13A單位電插座	1	2	2	2
		Door Bell 門鈴	1	1	1	1
		Telephone Outlet 電話插座	1	-	-	-
		10A 1 Way 2 Gang SP Lighting Switch 10A二位一路燈掣	1	1	1	1
		Ceiling Light Point 天花燈位	-	1	1	1
		Downlight 天花燈	1	-	-	-
		Fused Switch for Exhaust Fan and Fresh Air Fan 抽氣扇及鮮風扇接線位	3	3	3	3
	Store Room 2 儲物室 2	Ceiling Light Point 天花燈位	-	1	1	1
	Lavatory adjacent to Store Room 儲物室一傍之洗手間	Ceiling Light Point 天花燈位	1	-	-	-
	Corridor 走廊	10A 1 Way 1 Gang SP Lighting Switch 10A一位一路燈掣	2	2	2	2
		10A 2 Way 1 Gang Lighting Switch 10A一位二路燈掣	-	1	1	1
		10A 2 Way 2 Gang Lighting Switch 10A二位二路燈掣	1	-	-	-
		Switch for Exhaust Fan 抽氣扇開關	1	1	1	1
		Door Bell Push Button 門鈴按鈕	1	1	1	1
		Downlight 天花燈	2	2	2	2
		Motion Sensor 動作感測器	1	-	-	-
	Car Park 車庫	Miniature Circuit Breaker Board 配電箱	1	1	1	1
		Downlight 天花燈	2	2	2	2
		13A Socket Outlet 電動車13A電插座	2	2	2	2
	Fire Service Pump Room 消防泵房	13A Watertight Socket Outlet 13A防水電插座	1	1	1	1
		Fused Switch for Exhaust Fan and Fresh Air Fan 抽氣扇及鮮風扇接線位	1	1	1	1
		Fluorescent Light 日光燈	1	1	1	1

Casa Regalia 富豪·悦庭

Floor 樓層	Location 位置	Mechanical and Electrical Provisions 機電裝置	75A Tan Kwai Tsuen Road, Casa Regalia 富豪·悦庭丹桂村路75A號	75B Tan Kwai Tsuen Road, Casa Regalia 富豪·悦庭丹桂村路75B號	77A & 77B Tan Kwai Tsuen Road, Casa Regalia 富豪·悦庭丹桂村路 77A及77B號	85A, 85B, 85C & 85D Tan Kwai Tsuen Road, Casa Regalia 富豪·悦庭丹桂村路 85A、85B、85C及85D號
G/F 地下	Living / Dining Room 客飯廳	Window Curtain Switch 電捲簾開關	1	-	-	-
		Switch for Exhaust Fan 抽氣扇開關	2	2	2	2
		13A Socket Outlet 13A單位電插座	3	-	-	-
		13A Twin Socket Outlet 13A雙位電插座	4	5	5	5
		TV and FM Outlet 電視及電台天線插座	2	3	3	3
		Telephone Outlet 電話插座	1	2	2	2
		10A 1 Way 1 Gang SP Lighting Switch 10A一位一路燈掣	1	1	1	2
		10A 1 Way 2 Gang SP Lighting Switch 10A二位一路燈掣	3	3	3	2
		10A 1 Way 3 Gang SP Lighting Switch 10A三位一路燈掣	-	1	1	1
		10A 1 Way 4 Gang SP Lighting Switch 10A四位一路燈掣	1	-	-	-
		10A 2 Way 2 Gang SP Lighting Switch 10A二位二路燈掣	2	-	-	-
		10A 2 Way 4 Gang SP Lighting Switch 10A四位二路燈掣	2	-	-	-
		Video Doorphone 視像門口對講機	1	1	1	1
		Downlight 天花燈	12	5	5	5
		Ceiling Light Point 天花燈位	1	1	1	1
		Fused Switch for Air-Conditioner 室內空調機接線位	2	2	2	2
Concealed Type AC Indoor Unit 隱藏室內空調機	2	2	2	2		

Casa Regalia 富豪·悦庭

Floor 樓層	Location 位置	Mechanical and Electrical Provisions 機電裝置	75A Tan Kwai Tsuen Road, Casa Regalia 富豪·悦庭丹桂村路75A號	75B Tan Kwai Tsuen Road, Casa Regalia 富豪·悦庭丹桂村路75B號	77A & 77B Tan Kwai Tsuen Road, Casa Regalia 富豪·悦庭丹桂村路 77A及77B號	85A, 85B, 85C & 85D Tan Kwai Tsuen Road, Casa Regalia 富豪·悦庭丹桂村路 85A、85B、85C及85D號
G/F 地下	Kitchen 廚房	13A Socket Outlet 13A單位電插座	7	7	7	7
		13A Twin Socket Outlet 13A雙位電插座	2	2	2	2
		TV and FM Outlet 電視及電台天線插座	1	1	1	1
		Door Bell 門鈴	1	1	1	1
		Downlight 天花燈	10	10	10	10
		Washing Machine Connection Point (Water Inlet) 洗衣機接駁點(來水位)	1	1	1	1
		Washing Machine Connection Point (Water Outlet) 洗衣機接駁點(去水位)	1	1	1	1
		Gas Meter 煤氣計量錶	1	1	1	1
	Guest Lavatory 客人洗手間	Downlight 天花燈	2	2	2	2
	Garden 花園	Video Doorphone Panel 大門入口視像對講機	1	1	1	1
		Outdoor Wall Mount Light 戶外掛牆照明燈	3	3	3	4
		13A Watertight Socket Outlet 13A防水電插座	2	2	2	2
		Outdoor Foot Light 戶外牆身照明燈	4	4	4	2
		Outdoor Ceiling Mount Light 戶外天花照明燈	2	-	-	-
		Outdoor Planter Light 戶外植物照明燈	7	-	-	-

Casa Regalia 富豪·悦庭

Floor 樓層	Location 位置	Mechanical and Electrical Provisions 機電裝置	75A Tan Kwai Tsuen Road, Casa Regalia 富豪·悦庭丹桂村路75A號	75B Tan Kwai Tsuen Road, Casa Regalia 富豪·悦庭丹桂村路75B號	77A & 77B Tan Kwai Tsuen Road, Casa Regalia 富豪·悦庭丹桂村路 77A及77B號	85A, 85B, 85C & 85D Tan Kwai Tsuen Road, Casa Regalia 富豪·悦庭丹桂村路 85A、85B、85C及85D號
1/F 一樓	Bedroom 1 睡房 1	10A 1 Way 1 Gang SP Lighting Switch 10A一位一路燈掣	-	2	2	2
		10A 1 Way 2 Gang SP Lighting Switch 10A二位一路燈掣	1	1	1	1
		10A 2 Way 4 Gang SP Lighting Switch 10A四位二路燈掣	2	-	-	-
		Switch for Exhaust Fan 抽氣扇開關	1	1	1	1
		13A Socket Outlet 13A單位電插座	2	-	-	-
		13A Twin Socket Outlet 13A雙位電插座	4	3	3	3
		TV Outlet 電視天線插座	2	-	-	-
		TV and FM Outlet 電視及電台天線插座	-	1	1	1
		Telephone Outlet 電話插座	1	1	1	1
		Ceiling Light Point 天花燈位	-	1	1	1
		Downlight 天花燈	4	-	-	-
		Fused Switch for Air-Conditioner 室內空調機接線位	1	1	1	1
		Indoor Air-Conditioner 室內空調機	1	1	1	1
	Bedroom 2 睡房 2	Switch for Exhaust Fan 抽氣扇開關	1	1	1	1
		13A Socket Outlet 13A單位電插座	2	-	-	-
		13A Twin Socket Outlet 13A雙位電插座	4	3	3	3
		TV Outlet 電視天線插座	2	-	-	-
		TV and FM Outlet 電視及電台天線插座	-	1	1	1
		Telephone Outlet 電話插座	1	1	1	1
		10A 1 Way 1 Gang SP Lighting Switch 10A一位一路燈掣	1	2	2	2
		10A 1 Way 2 Gang SP Lighting Switch 10A二位一路燈掣	-	1	1	1
		10A 1 Way 4 Gang SP Lighting Switch 10A四位一路燈掣	1	-	-	-
		10A 2 Way 4 Gang SP Lighting Switch 10A四位二路燈掣	2	-	-	-
Ceiling Light Point 天花燈位	1	1	1	1		
Downlight 天花燈	6	-	-	-		

Casa Regalia 富豪·悦庭

Floor 樓層	Location 位置	Mechanical and Electrical Provisions 機電裝置	75A Tan Kwai Tsuen Road, Casa Regalia 富豪·悦庭丹桂村路75A號	75B Tan Kwai Tsuen Road, Casa Regalia 富豪·悦庭丹桂村路75B號	77A & 77B Tan Kwai Tsuen Road, Casa Regalia 富豪·悦庭丹桂村路 77A及77B號	85A, 85B, 85C & 85D Tan Kwai Tsuen Road, Casa Regalia 富豪·悦庭丹桂村路 85A、85B、85C及85D號
1/F 一樓	Bedroom 2 睡房 2	Fused Switch for Air-Conditioner 室內空調機接線位	1	1	1	1
		Indoor Air-Conditioner 室內空調機	1	1	1	1
	Bathroom 1 浴室 1	13A Socket Outlet 13A單位電插座	1	2	2	2
		Downlight 天花燈	2	3	3	3
		Gas Water Heater Controller 煤氣熱水爐溫度控制	1	1	1	1
	Bathroom 2 浴室 2	13A Socket Outlet 13A單位電插座	1	2	2	2
		Downlight 天花燈	2	3	3	3
	Balcony for Bedroom 1 睡房1露台	Balcony Light 露台照明燈	2	1	1	1
	Flat Roof for Bedroom 2 睡房2平台	Outdoor Wall Mount Light 戶外掛牆照明燈	1	1	1	1
	2/F 二樓	Master Bedroom 主人睡房	10A 1 Way 1 Gang SP Lighting Switch 10A一位一路燈掣	1	2	2
10A 1 Way 2 Gang SP Lighting Switch 10A二位一路燈掣			-	1	1	1
10A 1 Way 4 Gang SP Lighting Switch 10A四位一路燈掣			1	-	-	-
10A 2 Way 4 Gang SP Lighting Switch 10A四位二路燈掣			2	-	-	-
Switch for Exhaust Fan 抽氣扇開關			1	-	-	-
2 Gang Double Pole Switch for Exhaust Fan and Heat Lamp 抽氣扇及暖燈雙開關			-	1	1	1
13A Socket Outlet 13A單位電插座			2	-	-	-
13A Twin Socket Outlet 13A雙位電插座			4	3	3	3
TV Outlet 電視天線插座			2	-	-	-
TV and FM Outlet 電視及電台天線插座			-	1	1	1
Telephone Outlet 電話插座			1	1	1	1
Door Bell 門鈴	1	1	1	1		

Casa Regalia 富豪·悦庭

Floor 樓層	Location 位置	Mechanical and Electrical Provisions 機電裝置	75A Tan Kwai Tsuen Road, Casa Regalia 富豪·悦庭丹桂村路75A號	75B Tan Kwai Tsuen Road, Casa Regalia 富豪·悦庭丹桂村路75B號	77A & 77B Tan Kwai Tsuen Road, Casa Regalia 富豪·悦庭丹桂村路 77A及77B號	85A, 85B, 85C & 85D Tan Kwai Tsuen Road, Casa Regalia 富豪·悦庭丹桂村路 85A、85B、85C及85D號
2/F 二樓	Master Bedroom 主人睡房	Ceiling Light Point 天花燈位	-	2	2	2
		Downlight 天花燈	6	-	-	-
		Fused Switch for Air-Conditioner 室內空調機接線位	1	1	1	1
		Indoor Air-Conditioner 室內空調機	1	1	1	1
	Master Bathroom 主人房浴室	13A Socket Outlet 13A單位電插座	3	3	3	3
		TV Outlet 電視天線插座	2	-	-	-
		TV and FM Outlet 電視及電台天線插座	-	1	1	1
		Gas Water Heater Controller 煤氣熱水爐溫度控制	1	1	1	1
		Heat Lamp 天花暖燈	-	1	1	1
	Flat Roof for Master Bedroom 主人睡房平台	Downlight 天花燈	2	7	7	7
Outdoor Wall Mount Light 戶外掛牆照明燈		2	2	2	2	
B/F - Roof 地庫至天台	Internal Staircase and Landings 室內樓梯及通道	13A Socket Outlet 13A單位電插座	4	-	-	-
		10A 1 Way 1 Gang SP Lighting Switch 10A一位一路燈掣	-	1	1	1
		10A 1 Way 2 Gang SP Lighting Switch 10A二位一路燈掣	1	-	-	-
		10A 2 Way 1 Gang SP Lighting Switch 10A一位二路燈掣	5	4	4	4
		10A 2 Way 2 Gang SP Lighting Switch 10A二位二路燈掣	1	-	-	-
		Door Bell 門鈴	2	2	2	2
		Indoor Wall Mount Light 室內掛牆照明燈	1	1	1	1
		Ceiling Light Point 天花燈位	-	8	8	8
		Downlight 天花燈	14	-	-	-
Roof 天台		Isolator for Outdoor Unit (Air Conditioner) 室外開關掣(空調機)	1	1	1	1
		13A Watertight Socket Outlet 13A防水電插座	1	1	1	1
		Outdoor Foot Light 戶外牆身照明燈	3	3	3	3
		Outdoor Plant Light 戶外植物照明燈	4	-	-	-
		Water Heater 熱水爐	2	2	2	2
		Outdoor Air-Conditioner 室外空調機	1	1	1	1

Casa Regalia 富豪·悦庭

Floor 樓層	Location 位置	Mechanical and Electrical Provisions 機電裝置	79A Tan Kwai Tsuen Road, Casa Regalia 富豪·悦庭 丹桂村路 67A號	87A & 87C Tan Kwai Tsuen Road, Casa Regalia 富豪·悦庭 丹桂村路 87A及87C號	79B Tan Kwai Tsuen Road, Casa Regalia 富豪·悦庭 丹桂村路 79B號	87B Tan Kwai Tsuen Road, Casa Regalia 富豪·悦庭 丹桂村路 87B號	79C Tan Kwai Tsuen Road, Casa Regalia 富豪·悦庭 丹桂村路 79C號	79D Tan Kwai Tsuen Road, Casa Regalia 富豪·悦庭 丹桂村路 79D號	87D Tan Kwai Tsuen Road, Casa Regalia 富豪·悦庭 丹桂村路 87D號	79E Tan Kwai Tsuen Road, Casa Regalia 富豪·悦庭 丹桂村路 79E號	79F & 87E Tan Kwai Tsuen Road, Casa Regalia 富豪·悦庭 丹桂村路 79F及87E號
B/F 地庫	Store Room 1 儲物室 1	2 Gang Double Pole Switch for Exhaust Fan 抽氣扇雙開關	1	1	1	1	1	1	1	1	1
		Switch for Exhaust Fan 抽氣扇開關	1	1	1	1	1	1	1	1	1
		13A Socket Outlet 13A單位電插座	2	2	2	2	2	2	2	2	2
		Door Bell 門鈴	1	1	1	1	1	1	1	1	1
		10A 1 Way 2 Gangs Lighting Switch 10A二位一路燈掣	1	1	1	1	1	1	1	1	1
		Ceiling Light Point 天花燈位	1	1	1	1	1	1	1	1	1
		Fused Switch for Exhaust Fan and Fresh Air Fan 抽氣扇及鮮風扇接線位	3	3	3	3	3	3	3	3	3
	Store Room 2 儲物室 2	Ceiling Light Point 天花燈位	1	1	1	1	1	1	1	1	1
	Corridor 走廊	10A 2 Way 1 Gang SP Lighting Switch 10A一位二路燈掣	1	1	1	1	1	1	1	1	1
		Downlight 天花燈	1	1	1	1	1	1	1	1	1
	Car Park 車庫	10A 1 Way 1 Gang SP Lighting Switch 10A單位燈掣	2	2	1	2	1	1	2	2	2
		Switch for Exhaust Fan 抽氣扇開關	1	1	-	1	-	-	1	1	1
		Miniature Circuit Breaker Board 配電箱	1	1	1	1	1	1	1	1	1
		Door Bell Push Button 門鈴按鈕	1	1	1	1	1	1	1	1	1
		Downlight 天花燈	1	2	2	2	2	2	1	1	1
		13A Socket Outlet 電動車13A電插座	1	2	2	2	2	2	1	1	1
	Fire Service Pump Room 消防泵房	10A 1 Way 1 Gang SP Lighting Switch 10A一位一路燈掣	-	-	1	-	1	1	-	-	-
		Switch for Exhaust Fan 抽氣扇開關	-	-	1	-	1	1	-	-	-
		13A Watertight Socket Outlet 13A防水電插座	1	1	1	1	1	1	1	1	1
		Fused Switch for Exhaust Fan and Fresh Air Fan 抽氣扇及鮮風扇接線位	1	1	1	1	1	1	1	1	1
Fluorescent Light 日光燈		1	3	3	3	3	3	2	2	2	

Casa Regalia 富豪·悦庭

Floor 樓層	Location 位置	Mechanical and Electrical Provisions 機電裝置	79A Tan Kwai Tsuen Road, Casa Regalia 富豪·悦庭 丹桂村路 67A號	87A & 87C Tan Kwai Tsuen Road, Casa Regalia 富豪·悦庭 丹桂村路 87A及87C號	79B Tan Kwai Tsuen Road, Casa Regalia 富豪·悦庭 丹桂村路 79B號	87B Tan Kwai Tsuen Road, Casa Regalia 富豪·悦庭 丹桂村路 87B號	79C Tan Kwai Tsuen Road, Casa Regalia 富豪·悦庭 丹桂村路 79C號	79D Tan Kwai Tsuen Road, Casa Regalia 富豪·悦庭 丹桂村路 79D號	87D Tan Kwai Tsuen Road, Casa Regalia 富豪·悦庭 丹桂村路 87D號	79E Tan Kwai Tsuen Road, Casa Regalia 富豪·悦庭 丹桂村路 79E號	79F & 87E Tan Kwai Tsuen Road, Casa Regalia 富豪·悦庭 丹桂村路 79F及87E號	
G/F 地下	Living / Dining Room 客飯廳	10A 1 Way 1 Gang SP Lighting Switch 10A一位一路燈掣	2	2	2	2	2	2	2	2	1	
		10A 1 Way 3 Gang SP Lighting Switch 10A三位一路燈掣	1	1	1	1	1	1	1	1	1	
		Switch for Exhaust Fan 抽氣扇開關	2	2	2	2	2	2	2	2	2	2
		13A Twin Socket Outlet 13A雙位電插座	5	5	5	5	5	5	5	5	5	5
		TV and FM Outlet 電視及電台天線插座	2	2	2	2	2	2	2	2	2	2
		Telephone Outlet 電話插座	2	2	2	2	2	2	2	2	2	2
		10A 1 Way 2 Gang SP Lighting Switch 10A二位一路燈掣	2	2	2	2	2	2	2	2	2	2
		Video Doorphone 視像門口對講機	1	1	1	1	1	1	1	1	1	1
		Downlight 天花燈	5	5	5	5	5	5	5	5	5	5
		Ceiling Light Point 天花燈位	1	1	1	1	1	1	1	1	1	1
		Fused Switch for Air-Conditioner 室內空調機接線位	2	2	2	2	2	2	2	2	2	2
		Concealed Type AC Indoor Unit 隱藏室內空調機	2	2	2	2	2	2	2	2	2	2
	Kitchen 廚房	13A Socket Outlet 13A單位電插座	7	7	7	7	7	7	7	7	7	7
		13A Twin Socket Outlet 13A雙位電插座	2	2	2	2	2	2	2	2	2	2
		TV and FM Outlet 電視及電台天線插座	1	1	1	1	1	1	1	1	1	1
		Door Bell 門鈴	1	1	1	1	1	1	1	1	1	1
		Downlight 天花燈	10	10	10	10	10	10	10	10	10	10
		Washing Machine Connection Point (Water Inlet) 洗衣機接駁點(來水位)	1	1	1	1	1	1	1	1	1	1
		Washing Machine Connection Point (Water Outlet) 洗衣機接駁點(去水位)	1	1	1	1	1	1	1	1	1	1
		Gas Meter 煤氣計量錶	1	1	1	1	1	1	1	1	1	1
Guest Lavatory 客人洗手間	Downlight 天花燈	2	2	2	2	2	2	2	2	2		

Casa Regalia 富豪·悦庭

Floor 樓層	Location 位置	Mechanical and Electrical Provisions 機電裝置	79A Tan Kwai Tsuen Road, Casa Regalia 富豪·悦庭 丹桂村路 67A號	87A & 87C Tan Kwai Tsuen Road, Casa Regalia 富豪·悦庭 丹桂村路 87A及87C號	79B Tan Kwai Tsuen Road, Casa Regalia 富豪·悦庭 丹桂村路 79B號	87B Tan Kwai Tsuen Road, Casa Regalia 富豪·悦庭 丹桂村路 87B號	79C Tan Kwai Tsuen Road, Casa Regalia 富豪·悦庭 丹桂村路 79C號	79D Tan Kwai Tsuen Road, Casa Regalia 富豪·悦庭 丹桂村路 79D號	87D Tan Kwai Tsuen Road, Casa Regalia 富豪·悦庭 丹桂村路 87D號	79E Tan Kwai Tsuen Road, Casa Regalia 富豪·悦庭 丹桂村路 79E號	79F & 87E Tan Kwai Tsuen Road, Casa Regalia 富豪·悦庭 丹桂村路 79F及87E號
G/F 地下	Garden 花園	Video Doorphone Panel 大門入口視像對講機	1	1	1	1	1	1	1	1	1
		Outdoor Wall Mount Light 戶外掛牆照明燈	3	4	1	4	3	1	4	3	2
		13A Watertight Socket Outlet 13A防水電插座	2	2	1	2	1	1	1	1	1
		Outdoor Foot Light 戶外牆身照明燈	2	2	2	2	1	2	2	1	-

Casa Regalia 富豪·悦庭

Floor 樓層	Location 位置	Mechanical and Electrical Provisions 機電裝置	79A Tan Kwai Tsuen Road, Casa Regalia 富豪·悦庭 丹桂村路 67A號	87A & 87C Tan Kwai Tsuen Road, Casa Regalia 富豪·悦庭 丹桂村路 87A及87C號	79B Tan Kwai Tsuen Road, Casa Regalia 富豪·悦庭 丹桂村路 79B號	87B Tan Kwai Tsuen Road, Casa Regalia 富豪·悦庭 丹桂村路 87B號	79C Tan Kwai Tsuen Road, Casa Regalia 富豪·悦庭 丹桂村路 79C號	79D Tan Kwai Tsuen Road, Casa Regalia 富豪·悦庭 丹桂村路 79D號	87D Tan Kwai Tsuen Road, Casa Regalia 富豪·悦庭 丹桂村路 87D號	79E Tan Kwai Tsuen Road, Casa Regalia 富豪·悦庭 丹桂村路 79E號	79F & 87E Tan Kwai Tsuen Road, Casa Regalia 富豪·悦庭 丹桂村路 79F及87E號
1/F 一樓	Bedroom 1 睡房 1	10A 1 Way 1 Gang SP Lighting Switch 10A一位一路燈掣	2	2	2	2	2	2	2	2	2
		Switch for Exhaust Fan 抽氣扇開關	1	1	1	1	1	1	1	1	1
		13A Twin Socket Outlet 13A雙位電插座	3	3	3	3	3	3	3	3	3
		TV and FM Outlet 電視及電台天線插座	1	1	1	1	1	1	1	1	1
		Telephone Outlet 電話插座	1	1	1	1	1	1	1	1	1
		10A 1 Way 2 Gang SP Lighting Switch 10A二位一路燈掣	1	1	1	1	1	1	1	1	1
		Ceiling Light Point 天花燈位	1	1	1	1	1	1	1	1	1
		Fused Switch for Air-Conditioner 室內空調機接線位	1	1	1	1	1	1	1	1	1
	Indoor Air-Conditioner 室內空調機	1	1	1	1	1	1	1	1	1	
	Bedroom 2 睡房 2	10A 1 Way 1 Gang SP Lighting Switch 10A一位一路燈掣	2	2	2	2	2	2	2	2	2
		Switch for Exhaust Fan 抽氣扇開關	1	1	1	1	1	1	1	1	1
		13A Twin Socket Outlet 13A雙位電插座	3	3	3	3	3	3	3	3	3
		TV and FM Outlet 電視及電台天線插座	1	1	1	1	1	1	1	1	1
		Telephone Outlet 電話插座	1	1	1	1	1	1	1	1	1
		10A 1 Way 2 Gang SP Lighting Switch 10A二位一路燈掣	1	1	1	1	1	1	1	1	1
		Ceiling Light Point 天花燈位	1	1	1	1	1	1	1	1	1
Fused Switch for Air-Conditioner 室內空調機接線位		1	1	1	1	1	1	1	1	1	

Casa Regalia 富豪·悦庭

Floor 樓層	Location 位置	Mechanical and Electrical Provisions 機電裝置	79A Tan Kwai Tsuen Road, Casa Regalia 富豪·悦庭 丹桂村路 67A號	87A & 87C Tan Kwai Tsuen Road, Casa Regalia 富豪·悦庭 丹桂村路 87A及87C號	79B Tan Kwai Tsuen Road, Casa Regalia 富豪·悦庭 丹桂村路 79B號	87B Tan Kwai Tsuen Road, Casa Regalia 富豪·悦庭 丹桂村路 87B號	79C Tan Kwai Tsuen Road, Casa Regalia 富豪·悦庭 丹桂村路 79C號	79D Tan Kwai Tsuen Road, Casa Regalia 富豪·悦庭 丹桂村路 79D號	87D Tan Kwai Tsuen Road, Casa Regalia 富豪·悦庭 丹桂村路 87D號	79E Tan Kwai Tsuen Road, Casa Regalia 富豪·悦庭 丹桂村路 79E號	79F & 87E Tan Kwai Tsuen Road, Casa Regalia 富豪·悦庭 丹桂村路 79F及87E號
1/F 一樓	Bedroom 2 睡房 2	Indoor Air-Conditioner 室內空調機	1	1	1	1	1	1	1	1	1
	Bathroom 1 浴室 1	13A Socket Outlet 13A單位電插座	2	2	2	2	2	2	2	2	2
		Gas Water Heater Controller 煤氣熱水爐溫度控制	1	1	1	1	1	1	1	1	1
		Downlight 天花燈	3	3	3	3	3	3	3	3	3
	Bathroom 2 浴室 2	13A Socket Outlet 13A單位電插座	2	2	2	2	2	2	2	2	2
		Downlight 天花燈	3	3	3	3	3	3	3	3	3
Balcony for Bedroom 1 睡房1露台	Balcony Light 露台照明燈	1	1	1	1	1	1	1	1	1	
Flat Roof for Bedroom 2 睡房2平台	Outdoor Wall Mount Light 戶外掛牆照明燈	1	1	1	1	1	1	1	1	1	
2/F 二樓	Master Bedroom 主人睡房	10A 1 Way 1 Gang SP Lighting Switch 10A一位一路燈掣	2	2	2	2	2	2	2	2	2
		2 Gang Double Pole Switch for Exhaust Fan and Heat Lamp 抽氣扇及暖燈雙開關	1	1	1	1	1	1	1	1	1
		13A Twin Socket Outlet 13A雙位電插座	3	3	3	3	3	3	3	3	3
		TV and FM Outlet 電視及電台天線插座	1	1	1	1	1	1	1	1	1
		Telephone Outlet 電話插座	1	1	1	1	1	1	1	1	1
		Door Bell 門鈴	1	1	1	1	1	1	1	1	1
		10A 1 Way 2 Gang SP Lighting Switch 10A二位一路燈掣	1	1	1	1	1	1	1	1	1
		Ceiling Light Point 天花燈位	2	2	2	2	2	2	2	2	2
	Master Bathroom 主人房浴室	Fused Switch for Air-Conditioner 室內空調機接線位	2	2	2	2	2	2	2	2	2
		Indoor Air-Conditioner 室內空調機	2	2	2	2	2	2	2	2	2
		13A Socket Outlet 13A單位電插座	3	3	3	3	3	3	3	3	3
Master Bathroom 主人房浴室	TV and FM Outlet 電視及電台天線插座	1	1	1	1	1	1	1	1	1	
	Gas Water Heater Controller 煤氣熱水爐溫度控制	1	1	1	1	1	1	1	1	1	

Casa Regalia 富豪·悦庭

Floor 樓層	Location 位置	Mechanical and Electrical Provisions 機電裝置	79A Tan Kwai Tsuen Road, Casa Regalia 富豪·悦庭 丹桂村路 67A號	87A & 87C Tan Kwai Tsuen Road, Casa Regalia 富豪·悦庭 丹桂村路 87A及87C號	79B Tan Kwai Tsuen Road, Casa Regalia 富豪·悦庭 丹桂村路 79B號	87B Tan Kwai Tsuen Road, Casa Regalia 富豪·悦庭 丹桂村路 87B號	79C Tan Kwai Tsuen Road, Casa Regalia 富豪·悦庭 丹桂村路 79C號	79D Tan Kwai Tsuen Road, Casa Regalia 富豪·悦庭 丹桂村路 79D號	87D Tan Kwai Tsuen Road, Casa Regalia 富豪·悦庭 丹桂村路 87D號	79E Tan Kwai Tsuen Road, Casa Regalia 富豪·悦庭 丹桂村路 79E號	79F & 87E Tan Kwai Tsuen Road, Casa Regalia 富豪·悦庭 丹桂村路 79F及87E號
2/F 二樓	Master Bathroom 主人房浴室	Heat Lamp 天花暖燈	1	1	1	1	1	1	1	1	1
		Downlight 天花燈	7	7	7	7	7	7	7	7	7
	Flat Roof for Master Bedroom 主人睡房平台	Outdoor Wall Mount Light 戶外掛牆照明燈	2	2	2	2	2	2	2	2	2
B/F - R/F 地庫至天台	Internal Staircase and Landings 室內樓梯及通道	10A 1 Way 1 Gang SP Lighting Switch 10A一位一路燈掣	1	1	1	1	1	1	1	1	1
		Door Bell 門鈴	2	2	2	2	2	2	2	2	2
		10A 2 Way 1 Gang SP Lighting Switch 10A一位二路燈掣	4	4	4	4	4	4	4	4	4
		Indoor Wall Mount Light 室內掛牆照明燈	1	1	1	1	1	1	1	1	1
		Ceiling Light Point 天花燈位	8	8	8	8	8	8	8	8	8
Roof 天台		Isolator for Outdoor Unit (Air Conditioner) 室外開關掣(空調機)	1	1	1	1	1	1	1	1	1
		13A Watertight Socket Outlet 13A防水電插座	1	1	1	1	1	1	1	1	1
		Outdoor Foot Light 戶外牆身照明燈	3	3	3	3	3	3	3	3	3
		Water Heater 熱水爐	2	2	2	2	2	2	2	2	2
		Outdoor Air-Conditioner 室外空調機	1	1	1	1	1	1	1	1	1

FITTINGS, FINISHES AND APPLIANCES
裝置、裝修物料及設備

Casa Regalia 富豪·悦庭

Floor 樓層	Location 位置	Mechanical and Electrical Provisions 機電裝置	81 Tan Kwai Tsuen Road, Casa Regalia 富豪·悦庭丹桂村路 81號
B/F 地庫	Store Room 1 儲物室 1	10A 1 Way 1 Gang SP Lighting Switch 10A一位一路燈掣	2
		2 Gang Double Pole Switch for Exhaust Fan 抽氣扇雙開關	1
		Switch for Exhaust Fan 抽氣扇開關	1
		13A Socket Outlet 13A單位電插座	2
		Door Bell 門鈴	1
		Ceiling Light Point 天花燈位	1
		Fused Switch for Exhaust Fan and Fresh Air Fan 抽氣扇及鮮風扇接線位	3
	Store Room 2 儲物室 2	10A 1 Way 1 Gang SP Lighting Switch 10A一位一路燈掣	1
		Switch for Exhaust Fan 抽氣扇開關	1
		Fused Switch for Exhaust Fan and Fresh Air Fan 抽氣扇and鮮風扇接線位	1
		Ceiling Light Point 天花燈位	1
	Lavatory adjacent to Store Room 1 儲物室一傍之洗手間	Ceiling Light Point 天花燈位	2
	Lift Lobby 電梯大堂	10A 1 Way 1 Gang SP Lighting Switch 10A一位一路燈掣	1
		10A 2 Way 1 Gang SP Lighting Switch 10A單位二路燈掣	1
Downlight 天花燈		3	

Floor 樓層	Location 位置	Mechanical and Electrical Provisions 機電裝置	81 Tan Kwai Tsuen Road, Casa Regalia 富豪·悦庭丹桂村路 81號
B/F 地庫	Car Park 車庫	10A 1 Way 1 Gang SP Lighting Switch 10A一位一路燈掣	2
		Switch for Exhaust Fan 抽氣扇開關	1
		Door Bell Push Button 門鈴按鈕	1
		Miniature Circuit Breaker Board 配電箱	1
		Downlight 天花燈	3
		13A Socket Outlet 電動車13A電插座	3
		13A Watertight Socket Outlet 13A防水電插座	1
	Fire Service Pump Room 消防泵房	Fused Switch for Exhaust Fan and Fresh Air Fan 抽氣扇及鮮風扇接線位	1
		Fluorescent Light 日光燈	1

Casa Regalia 富豪·悦庭

Floor 樓層	Location 位置	Mechanical and Electrical Provisions 機電裝置	81 Tan Kwai Tsuen Road, Casa Regalia 富豪·悦庭丹桂村路 81號
G/F 地下	Living / Dining Room 客飯廳	Switch for Exhaust Fan 抽風扇開關	2
		13A Socket Outlet 13A單位電插座	8
		TV and FM Outlet 電視及電台天線插座	2
		Telephone Outlet 電話插座	2
		10A 1 Way 2 Gang SP Lighting Switch 10A二位一路燈掣	3
		10A 1 Way 3 Gang SP Lighting Switch 10A三位一路燈掣	1
		10A 2 Way 2 Gang SP Lighting Switch 10A二位二路燈掣	1
		Video Doorphone 視像門口對講機	1
		Ceiling Light Point 天花燈位	2
		Fused Switch for Air-Conditioner 室內空調機接線位	3
	Concealed Type AC Indoor Unit 隱藏室內空調機	3	
	Kitchen 廚房	13A Socket Outlet 13A單位電插座	7
		13A Twin Socket Outlet 13A雙位電插座	2
		TV and FM Outlet 電視及電台天線插座	1
		Door Bell 門鈴	1
		Downlight 天花燈	8
		Washing Machine Connection Point (Water Inlet) 洗衣機接駁點(來水位)	1
		Washing Machine Connection Point (Water Outlet) 洗衣機接駁點(去水位)	1
	Gas Meter 煤氣計量錶	1	
Guest Lavatory 客人洗手間	Ceiling Light Point 天花燈位	2	

Floor 樓層	Location 位置	Mechanical and Electrical Provisions 機電裝置	81 Tan Kwai Tsuen Road, Casa Regalia 富豪·悦庭丹桂村路 81號
G/F 地下	Garden 花園	Video Doorphone Panel 大門入口視像對講機	1
		Outdoor Wall Mount Light 戶外掛牆照明燈	3
		13A Watertight Socket Outlet 13A防水電插座	2
		Outdoor Foot Light 戶外牆身照明燈	4
1/F 一樓	Bedroom 1 睡房 1	10A 1 Way 1 Gang SP Lighting Switch 10A一位一路燈掣	2
		Double Pole Switch for Exhaust Fan 抽風扇雙開關	1
		13A Twin Socket Outlet 13A雙位電插座	3
		TV and FM Outlet 電視及電台天線插座	1
		Telephone Outlet 電話插座	1
	Bedroom 2 睡房 2	10A 1 Way 2 Gang SP Lighting Switch 10A二位一路燈掣	1
		Ceiling Light Point 天花燈位	1
		Fused Switch for Air-Conditioner 室內空調機接駁位	1
		Indoor Air-Conditioner 室內空調機	1
		10A 1 Way 1 Gang SP Lighting Switch 10A一位一路燈掣	2
1/F 一樓	Bedroom 2 睡房 2	Double Pole Switch for Exhaust Fan 抽風扇雙開關	1
		13A Twin Socket Outlet 13A雙位電插座	3
		TV and FM Outlet 電視及電台天線插座	1
		Telephone Outlet 電話插座	1
		10A 1 Way 2 Gang SP Lighting Switch 10A二位一路燈掣	1
		Ceiling Light Point 天花燈位	2

FITTINGS, FINISHES AND APPLIANCES
裝置、裝修物料及設備

Casa Regalia 富豪·悦庭

Floor 樓層	Location 位置	Mechanical and Electrical Provisions 機電裝置	81 Tan Kwai Tsuen Road, Casa Regalia 富豪·悦庭丹桂村路 81號
1/F 一樓	Bedroom 2 睡房 2	Fused Switch for Air-Conditioner 室內空調機接線位	1
		Indoor Air-Conditioner 室內空調機	1
	Bedroom 3 睡房 3	10A 1 Way 1 Gang SP Lighting Switch 10A一位一路燈掣	1
		Double Pole Switch for Exhaust Fan 抽風扇雙開關	1
		13A Twin Socket Outlet 13A雙位電插座	3
		TV and FM Outlet 電視及電台天線插座	1
		Telephone Outlet 電話插座	1
		10A 1 Way 2 Gang SP Lighting Switch 10A二位一路燈掣	1
		Ceiling Light Point 天花燈位	2
		Fused Switch for Air-Conditioner 室內空調機接線位	1
		Indoor Air-Conditioner 室內空調機	1
		Bathroom 1 浴室 1	13A Socket Outlet 13A單位電插座
	Ceiling Light Point 天花燈位		3
	Gas Water Heater Controller 煤氣熱水爐溫度控制		1
	Bathroom 2 浴室 2	13A Socket Outlet 13A單位電插座	2
		Ceiling Light Point 天花燈位	3
	Bathroom 3 浴室 3	13A Socket Outlet 13A單位電插座	2
		Ceiling Light Point 天花燈位	3
		Gas Water Heater Controller 煤氣熱水爐溫度控制	1

Floor 樓層	Location 位置	Mechanical and Electrical Provisions 機電裝置	81 Tan Kwai Tsuen Road, Casa Regalia 富豪·悦庭丹桂村路 81號
1/F 一樓	Lobby 大堂	10A 1 Way 1 Gang SP Lighting Switch 10A一位一路燈掣	1
		13A Twin Socket Outlet 13A雙位電插座	1
		TV and FM Outlet 電視及電台天線插座	1
		Telephone Outlet 電話插座	1
		Ceiling Light Point 天花燈位	2
		Fused Switch for Air-Conditioner 室內空調機接線位	1
		Indoor Air-Conditioner 室內空調機	1
		Flat Roof for Bedroom 1 睡房1平台	Outdoor Wall Mount Light 戶外掛牆照明燈
	Balcony for Bedroom 2 睡房2露台	Balcony Light 露台照明燈	1

Casa Regalia 富豪·悦庭

Floor 樓層	Location 位置	Mechanical and Electrical Provisions 機電裝置	81 Tan Kwai Tsuen Road, Casa Regalia 富豪·悦庭丹桂村路 81號
2/F 二樓	Master Bedroom 主人睡房	10A 1 Way 1 Gang SP Lighting Switch 10A一位一路燈掣	1
		2 Gang Double Pole Switch for Exhaust Fan and Heat Lamp 抽風扇及暖燈雙開關	1
		13A Twin Socket Outlet 13A雙位電插座	4
		TV and FM Outlet 電視及電台天線插座	1
		Telephone Outlet 電話插座	1
		10A 1 Way 2 Gang SP Lighting Switch 10A二位一路燈掣	2
		Ceiling Light Point 天花燈位	2
		Fused Switch for Air-Conditioner 室內空調機接線位	2
	Indoor Air-Conditioner 室內空調機	2	
	Master Bathroom 主人房浴室	13A Socket Outlet 13A單位電插座	3
		TV and FM Outlet 電視及電台天線插座	1
		Heat Lamp 天花暖燈	1
		Ceiling Light Point 天花燈位	7
		Gas Water Heater Controller 煤氣熱水爐溫度控制	1
Study Room 書房	13A Twin Socket Outlet 13A雙位電插座	4	
	TV and FM Outlet 電視及電台天線插座	1	
2/F 二樓	Study Room 書房	Telephone Outlet 電話插座	1
		Ceiling Light Point 天花燈位	2
		Fused Switch for Air-Conditioner 室內空調機接線位	1
		Indoor Air-Conditioner 室內空調機	1
	Flat Roof for Master Bedroom 主人睡房平台	Outdoor Wall Mount Light 戶外掛牆照明燈	2

Floor 樓層	Location 位置	Mechanical and Electrical Provisions 機電裝置	81 Tan Kwai Tsuen Road, Casa Regalia 富豪·悦庭丹桂村路 81號
B/F - R/F 地庫 至 天台	Internal Staircase and Landings 室內樓梯及通道	10A 1 Way 1 Gang SP Lighting Switch 10A一位一路燈掣	1
		Door Bell 門鈴	3
		10A 2 Way 1 Gang SP Lighting Switch 10A一位二路燈掣	2
		Ceiling Light Point 天花燈位	5
Roof 天台		Isolator for Outdoor Unit (Air Conditioner) 室外開關掣(空調機)	1
		13A Watertight Socket Outlet 13A防水電插座	1
		Outdoor Foot Light 戶外牆身照明燈	4
		Water Heater 熱水爐	3
		Outdoor Air-Conditioner 室外空調機	1

Casa Regalia 富豪·悦庭

Floor 樓層	Location 位置	Mechanical and Electrical Provisions 機電裝置	89 Tan Kwai Tsuen Road, Casa Regalia 富豪·悦庭丹桂村路 89號
B/F 地庫	Store Room 1 儲物室 1	10A 1 Way 1 Gang SP Lighting Switch 10A一位一路燈掣	2
		Switch for Exhaust Fan 抽風扇開關	2
		13A Socket Outlet 13A單位電插座	2
		Door Bell 門鈴	1
		Ceiling Light Point 天花燈位	1
		Fused Switch for Exhaust Fan and Fresh Air Fan 抽氣扇及鮮風扇接線位	3
		Lavatory adjacent to Store Room 1 儲物室一傍之洗手間	Ceiling Light Point 天花燈位
	Lift Lobby 電梯大堂	10A 1 Way 1 Gang SP Lighting Switch 10A一位一路燈掣	2
		Switch for Exhaust Fan 抽風扇開關	1
		Downlight 天花燈	3
	Car Park 車庫	10A 1 Way 1 Gang SP Lighting Switch 10A單位燈掣	2
		Switch for Exhaust Fan 抽風扇開關	1
		Door Bell Push Button 門鈴按鈕	1
		Miniature Circuit Breaker Board 配電箱	1
		Downlight 天花燈	3
B/F 地庫	Fire Service Pump Room 消防泵房	13A Watertight Socket Outlet 13A防水電插座	1
		Fused Switch for Exhaust Fan and Fresh Air Fan 抽氣扇及鮮風扇接線位	1
		Fluorescent Light 日光燈	1

Floor 樓層	Location 位置	Mechanical and Electrical Provisions 機電裝置	89 Tan Kwai Tsuen Road, Casa Regalia 富豪·悦庭丹桂村路 89號
G/F 地下	Living / Dining Room 客飯廳	10A 1 Way 1 Gang SP Lighting Switch 10A一位一路燈掣	1
		Switch for Exhaust Fan 抽風扇開關	2
		13A Twin Socket Outlet 13A雙位電插座	9
		TV and FM Outlet 電視及電台天線插座	3
		Telephone Outlet 電話插座	3
		10A 1 Way 2 Gang SP Lighting Switch 10A二位一路燈掣	2
		10A 1 Way 3 Gang SP Lighting Switch 10A三位一路燈掣	2
		10A 2 Way 2 Gang SP Lighting Switch 10A二位二路燈掣	1
		Video Doorphone 視像門口對講機	1
		Ceiling Light Point 天花燈位	3
		Fused Switch for Air-Conditioner 室內空調機接線位	3
		Concealed Type AC Indoor Unit 隱藏室內空調機	3
	Kitchen 廚房	13A Socket Outlet 13A單位電插座	7
		13A Twin Socket Outlet 13A雙位電插座	2
		TV and FM Outlet 電視及電台天線插座	1
		Door Bell 門鈴	1
		Downlight 天花燈	8
		Gas Meter 煤氣計量錶	1
		Washing Machine Connection Point (Water Inlet) 洗衣機接駁點(來水位)	1
		Washing Machine Connection Point (Water Outlet) 洗衣機接駁點(去水位)	1
Guest Lavatory 客人洗手間	Ceiling Light Point 天花燈位	2	

Casa Regalia 富豪·悦庭

Floor 樓層	Location 位置	Mechanical and Electrical Provisions 機電裝置	89 Tan Kwai Tsuen Road, Casa Regalia 富豪·悦庭丹桂村路 89號
G/F 地下	Garden 花園	Video Doorphone Panel 大門入口視像對講機	1
		Outdoor Wall Mount Light 戶外掛牆照明燈	6
		13A Watertight Socket Outlet 13A防水電插座	2
		Outdoor Foot Light 戶外牆身照明燈	4
1/F 一樓	Bedroom 2 睡房 2	10A 1 Way 1 Gang SP Lighting Switch 10A一位一路燈掣	2
		Double Pole Switch for Exhaust Fan 抽氣扇雙開關	1
		13A Twin Socket Outlet 13A雙位電插座	3
		TV and FM Outlet 電視及電台天線插座	1
		Telephone Outlet 電話插座	1
		10A 1 Way 2 Gang SP Lighting Switch 10A二位一路燈掣	1
		Ceiling Light Point 天花燈位	2
		Fused Switch for Air-Conditioner 室內空調機接線位	1
	Bedroom 3 睡房 3	Indoor Air-Conditioner 室內空調機	1
		10A 1 Way 1 Gang SP Lighting Switch 10A一位一路燈掣	1
		Double Pole Switch for Exhaust Fan 抽氣扇雙開關	1
		13A Twin Socket Outlet 13A雙位電插座	3
		TV and FM Outlet 電視及電台天線插座	1
		Telephone Outlet 電話插座	1
Bedroom 3 睡房 3	10A 1 Way 2 Gang SP Lighting Switch 10A二位一路燈掣	1	
	Ceiling Light Point 天花燈位	2	

Floor 樓層	Location 位置	Mechanical and Electrical Provisions 機電裝置	89 Tan Kwai Tsuen Road, Casa Regalia 富豪·悦庭丹桂村路 89號
1/F 一樓	Bedroom 3 睡房 3	Fused Switch for Air-Conditioner 室內空調機接線位	1
		Indoor Air-Conditioner 室內空調機	1
	Bedroom 4 睡房 4	10A 1 Way 1 Gang SP Lighting Switch 10A一位一路燈掣	1
		Double Pole Switch for Exhaust Fan 抽氣扇雙開關	1
		13A Twin Socket Outlet 13A雙位電插座	3
		TV and FM Outlet 電視及電台天線插座	1
		Telephone Outlet 電話插座	1
		10A 1 Way 2 Gang SP Lighting Switch 10A二位一路燈掣	1
		Ceiling Light Point 天花燈位	2
		Fused Switch for Air-Conditioner 室內空調機接線位	1
	Family Room 起居室	Indoor Air-Conditioner 室內空調機	1
		10A 1 Way 1 Gang SP Lighting Switch 10A單位燈掣	1
		13A Twin Socket Outlet 13A雙位電插座	3
		TV and FM Outlet 電視及電台天線插座	1
		Telephone Outlet 電話插座	1
		Ceiling Light Point 天花燈位	1
	Bathroom 2 浴室 2	Fused Switch for Air-Conditioner 室內空調機接線位	1
		Indoor Air-Conditioner 室內空調機	1
	Bathroom 2 浴室 2	13A Socket Outlet 13A單位電插座	2
Ceiling Light Point 天花燈位		3	
Bathroom 3 浴室 3	13A Socket Outlet 13A單位電插座	2	
	Ceiling Light Point 天花燈位	2	
	Gas Water Heater Controller 煤氣熱水爐溫度控制	1	

FITTINGS, FINISHES AND APPLIANCES
裝置、裝修物料及設備

Casa Regalia 富豪·悦庭

Floor 樓層	Location 位置	Mechanical and Electrical Provisions 機電裝置	89 Tan Kwai Tsuen Road, Casa Regalia 富豪·悦庭丹桂村路 89號	
1/F 一樓	Bathroom 4 浴室 4	13A Socket Outlet 13A單位電插座	2	
		Ceiling Light Point 天花燈位	3	
		Gas Water Heater Controller 煤氣熱水爐溫度控制	1	
	Balcony for Bedroom 2 睡房2露台	Balcony Light 露台照明燈	1	
2/F 二樓	Master Bedroom 主人睡房	10A 1 Way 1 Gang SP Lighting Switch 10A一位一路燈掣	1	
		2 Gang Double Pole Switch for Exhaust Fan and Heat Lamp 抽風扇及暖燈雙開關	1	
		13A Twin Socket Outlet 13A雙位電插座	3	
		TV and FM Outlet 電視及電台天線插座	1	
		Telephone Outlet 電話插座	1	
		10A 1 Way 2 Gang SP Lighting Switch 10A二位一路燈掣	2	
		Ceiling Light Point 天花燈位	1	
		Downlight 天花燈	1	
		Fused Switch for Air-Conditioner 室內空調機接線位	2	
		Indoor Air-Conditioner 室內空調機	2	
		Bedroom 1 睡房 1	10A 1 Way 1 Gang SP Lighting Switch 10A一位一路燈掣	1
			Double Pole Switch for Exhaust Fan 抽風扇雙開關	1
			13A Twin Socket Outlet 13A雙位電插座	3
			TV and FM Outlet 電視及電台天線插座	1
			Telephone Outlet 電話插座	1
10A 1 Way 2 Gang SP Lighting Switch 10A二位一路燈掣	1			
Ceiling Light Point 天花燈位	2			
Fused Switch for Air-Conditioner 室內空調機接線位	1			
Indoor Air-Conditioner 室內空調機	1			

Floor 樓層	Location 位置	Mechanical and Electrical Provisions 機電裝置	89 Tan Kwai Tsuen Road, Casa Regalia 富豪·悦庭丹桂村路 89號
2/F 二樓	Master Bathroom 主人房浴室	13A Socket Outlet 13A單位電插座	3
		TV and FM Outlet 電視及電台天線插座	1
		Heat Lamp 天花暖燈	1
		Ceiling Light Point 天花燈位	7
		Gas Water Heater Controller 煤氣熱水爐溫度控制	1
		Bathroom 1 浴室 1	13A Socket Outlet 13A單位電插座
		Ceiling Light Point 天花燈位	3
	Flat Roof for Master Bedroom 主人睡房平台	Outdoor Wall Mount Light 戶外掛牆照明燈	2
B/F - R/F 地庫 至 天台	Internal Staircase and Landings 室內樓梯及通道	10A 1 Way 1 Gang SP Lighting Switch 10A一位一路燈掣	1
		Door Bell 門鈴	4
		10A 2 Way 1 Gang SP Lighting Switch 10A一位二路燈掣	2
		Ceiling Light Point 天花燈位	8
Roof 天台		Isolator for Outdoor Unit (Air Conditioner) 室外開關掣(空調機)	1
		Outdoor Foot Light 戶外牆身照明燈	4
		Water Heater 熱水爐	3
		13A Watertight Socket Outlet 13A防水電插座	1
		Outdoor Air-Conditioner 室外空調機	1

Potable and flushing water is supplied by Water Supplies Department
Electricity is supplied by CLP Power Hong Kong Limited
Towngas is supplied by The Hong Kong and China Gas Company Limited

食水及沖廁水由水務署供應。
電力由中華電力有限公司供應。
煤氣由香港中華煤氣有限公司供應。

GOVERNMENT RENT
地稅

The vendor will pay/has paid (as the case may be) all outstanding Government rent in respect of the land on which the Development is erected up to and including the date of the assignment of the residential property.

賣方將會支付 / 已經支付 (視情況而定) 就該發展項目所處地段的地稅直至及包括住宅物業之買賣成交日期。

MISCELLANEOUS PAYMENTS BY PURCHASER

買方的雜項付款

1. On the delivery of the vacant possession of the residential property to the purchaser, the purchaser is liable to reimburse the owner for the deposits for water, electricity and gas (deposit for gas applies to the purchaser of House only).
2. On that delivery, the purchaser is liable to pay to the owner a debris removal fee.

Note:

The purchaser should pay to the manager of the Development and not the owner the deposits for water, electricity and gas and debris removal fee.

1. 在向買方交付住宅物業在空置情況下的管有權時，買方須負責向擁有人補還水、電力及氣體的按金（氣體的按金只適用於洋房的買家）。
2. 在交付時，買方須向擁有人支付清理廢料的費用。

備註：

買方須向發展項目管理人而不須向擁有人繳付水、電力及氣體的按金及清理廢料的費用。

DEFECT LIABILITY WARRANTY PERIOD

欠妥之處的保養責任期

The defects liability warranty period for the residential properties and the fittings, finishes and appliances as provided in the agreement for sale and purchase is within six (6) months from the date of completion of the sale and purchase of the residential property.

按買賣合約的規定，住宅物業及買賣合約所列出的裝置、裝修物料及設備之欠妥之處的保養責任期為住宅物業買賣成交日期起計六 (6) 個月內。

1. The Land Grant requires the owners of the residential properties in the Development to maintain the slope and retaining structures at their own cost.
2. Special Condition No.(33) of the Land Grant stipulates that:
 - (a) Where there is or has been any cutting away, removal or setting back of any land, or any building up or filling in or any slope treatment works of any kind whatsoever, whether with or without the prior written consent of the Director, either within the Lot or on any Government land, which is or was done for the purpose of or in connection with the formation, levelling or development of the Lot or any part thereof or any other works required to be done by the Grantee under the conditions of the Land Grant, or for any other purpose, the Grantee shall at his own expense carry out and construct such slope treatment works, retaining walls or other support, protection, drainage or ancillary or other works as shall or may then or at any time thereafter be necessary to protect and support such land within the Lot and also any adjacent or adjoining Government or leased land and to obviate and prevent any falling away, landslip or subsidence occurring thereafter. The Grantee shall at all times during the term of the Land Grant maintain at his own expense the said land, slope treatment works, retaining walls or other support, protection, drainage or ancillary or other works in good and substantial repair and condition to the satisfaction of the Director.
 - (b) Nothing in sub-clause (a) of Special Condition No. (33) shall prejudice the Government's rights under the conditions of the Land Grant, in particular Special Condition No. (32) of the Land Grant.
 - (c) In the event that as a result of or arising out of any formation, levelling, development or other works done by the Grantee or owing to any other reason, any falling away, landslip or subsidence occurs at any time, whether in or from any land, within the Lot or from any adjacent or adjoining Government or leased land, the Grantee shall at his own expense reinstate and make good the same to the satisfaction of the Director and shall indemnify the Government, its agents and contractors from and against all costs, charges, damages, demands and claims whatsoever which shall or may be made, suffered or incurred through or by reason of such falling away, landslip or subsidence.
 - (d) In addition to any other rights or remedies herein provided for breach of any of the conditions of the Land Grant, the Director shall be entitled by notice in writing to call upon the Grantee to carry out, construct and maintain the said land, slope treatment works, retaining walls, or other support, protection, and drainage or ancillary or other works or to reinstate and make good any falling away, landslip or subsidence, and if the Grantee shall neglect or fail to comply with the notice to the satisfaction of the Director within the period specified therein, the Director may forthwith execute and carry out any necessary works and the Grantee shall on demand repay to the Government the cost thereof, together with any administrative or professional fees and charges.
3. Each of the owners is obliged to contribute towards the costs of the maintenance work.
4. Under the deed of mutual covenant, the manager of the Development has the owners' authority to carry out the maintenance work.

1. 批地文件要求發展項目的住宅物業業主須自費保養斜坡及護土構築物。
2. 批地文件特別條款第（33）條規定：
 - (a) 如果任何土地需要或已經被挖除、移除或移後或堆積或堆填或進行任何類型的斜坡護土工程，不論有否經署長預先書面同意，亦不論是在該土地內或任何政府土地內，其目的旨在構建、平整或開發該地段或其中任何部分或承批人按該批地文件條款需要進行的任何其他工程或作任何其他用途，承批人須自行出資進行與建造其時及其後隨時必要的該等斜坡處理工程、護土牆或其他承托物、保護物、排水或輔助工程或其他工程，以便保護與承托該地段和任何毗鄰或毗連政府土地或出租土地內的泥土，避免與防止今後發生任何塌方、山泥傾瀉或地陷。承批人須在批地文件授予的租期期間自行出資保養該土地、斜坡處理工程、護土牆或其他承托物、保護物、排水或輔助工程或其他工程處於修繕妥當的狀態，使署長滿意。
 - (b) 特別條款第（33）條第（a）項不能影響本文件，特別是批地文件特別條款第（32）條賦予政府的權利
 - (c) 倘若因為任何構建、平整、開發或承批人進行其他工程或任何其他原因造成任何時候發生塌方、山泥傾瀉或地陷，不論發生在或來自該地段任何土地或任何毗鄰或毗連政府土地或出租土地，承批人須自費進行修復或修補，使署長滿意並對上述塌方、山泥傾瀉或地陷造成政府、他的代理人及承建商承受、遭受或產生一切費用、收費、損害賠償、要求及索償向彼等作出彌償。
 - (d) 除了批地文件規定對違反該等條件的任何其他權利或補救外，署長有權發出書面通知要求承批人進行、修建及保養該土地、斜坡處理工程、護土牆或其他承托物、保護物及排水或輔助工程或其他工程或修復與修補任何塌方、山泥傾瀉或地陷。如果承批人不理會或未能在通知指定的時期內執行該通知要求，使署長滿意，署長可立即執行與進行任何必要工程。承批人須在要求時歸還政府因此產生的費用及開支。
3. 每個業主有責任分擔保養工程的費用。
4. 根據公契規定，發展項目管理人具有業主的授權進行保養工程。

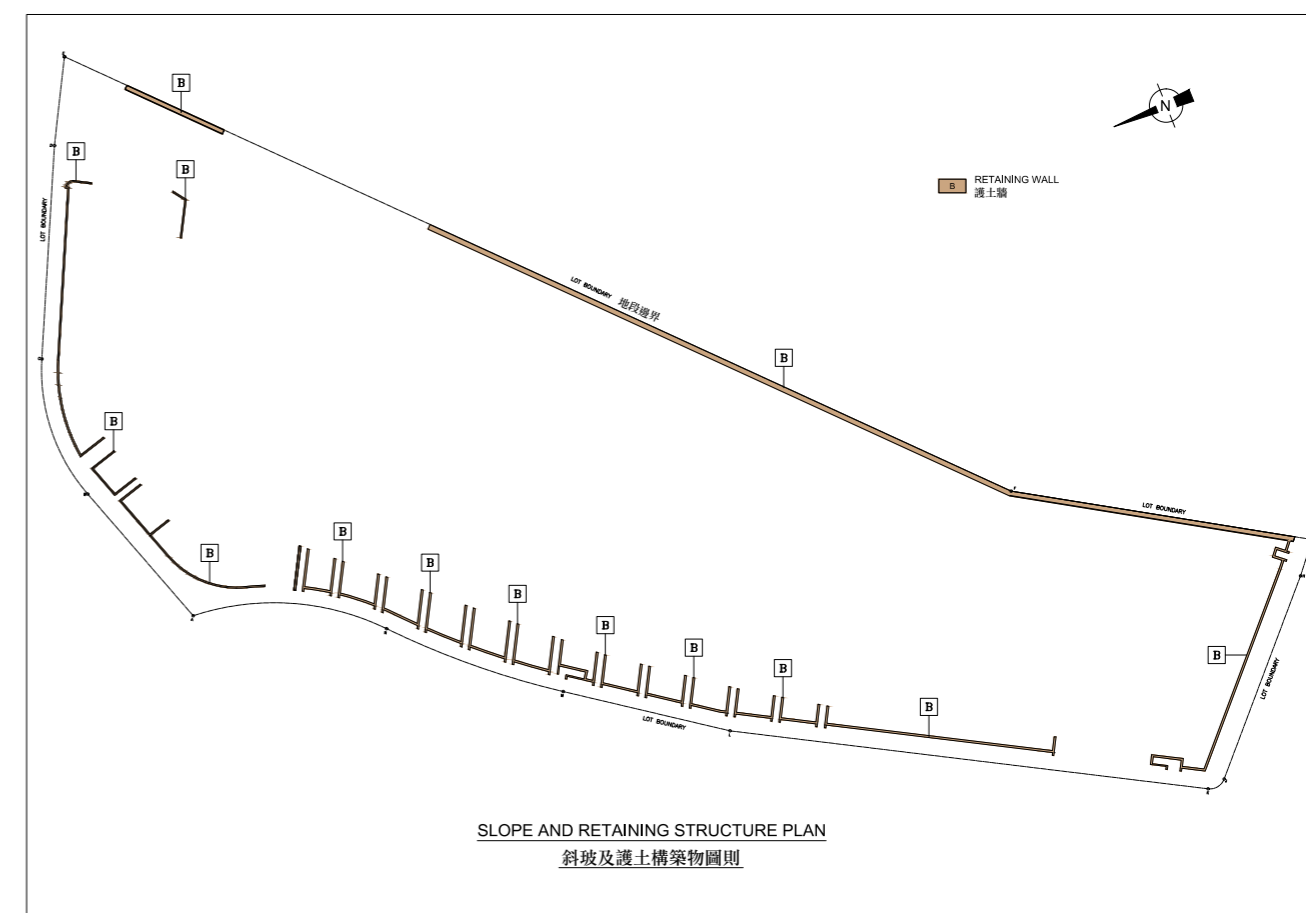

MODIFICATION 修訂

No existing application to the Government for a modification of the Land Grant for this Development has been made.

本發展項目現時並沒有向政府提出申請修訂批地文件。

RELEVANT INFORMATION 有關資料

1. Pursuant to the Land Grant, no tree growing on the lot or adjacent thereto shall be removed or interfered with without the prior written consent of the Director of Lands.
2. Pursuant to the Deed of Mutual Covenant :-
 - (a) The trees within the gardens of the residential properties shall be owned by the respective owners of those residential properties wherein they are planted. Each of the respective owners shall keep and maintain the tree(s) in his/her garden in a good healthy condition at his/her own cost and expenses.
 - (b) The trees in the common areas of the Development shall be kept and maintained by the manager of the Development at the owners' cost and expenses.
3. The latest Tree Compensation Plans approved by the District Lands Office, Yuen Long, Lands Department are reproduced on page 230 and 231.

1. 根據批地文件，未經地政署署長事先書面同意，不得移除或干擾該地段或毗連範圍內的樹木。
2. 根據公契：
 - (a) 在住宅物業的花園內栽種的樹木由該相關住宅物業的業主擁有。每名相關的業主須自費維持及保養在其花園內的樹木在一個良好健康的狀態。
 - (b) 在發展項目的公用地方內的樹木須由發展項目的管理人維持及保養，開支和費用由業主分擔。
3. 獲地政總署元朗地政處批核的最新版本的樹木補償計劃複印展示在第230及231頁。

Tree Compensation Plan (Ground Floor Plan)
樹木補償方案示意圖 (地下平面圖)

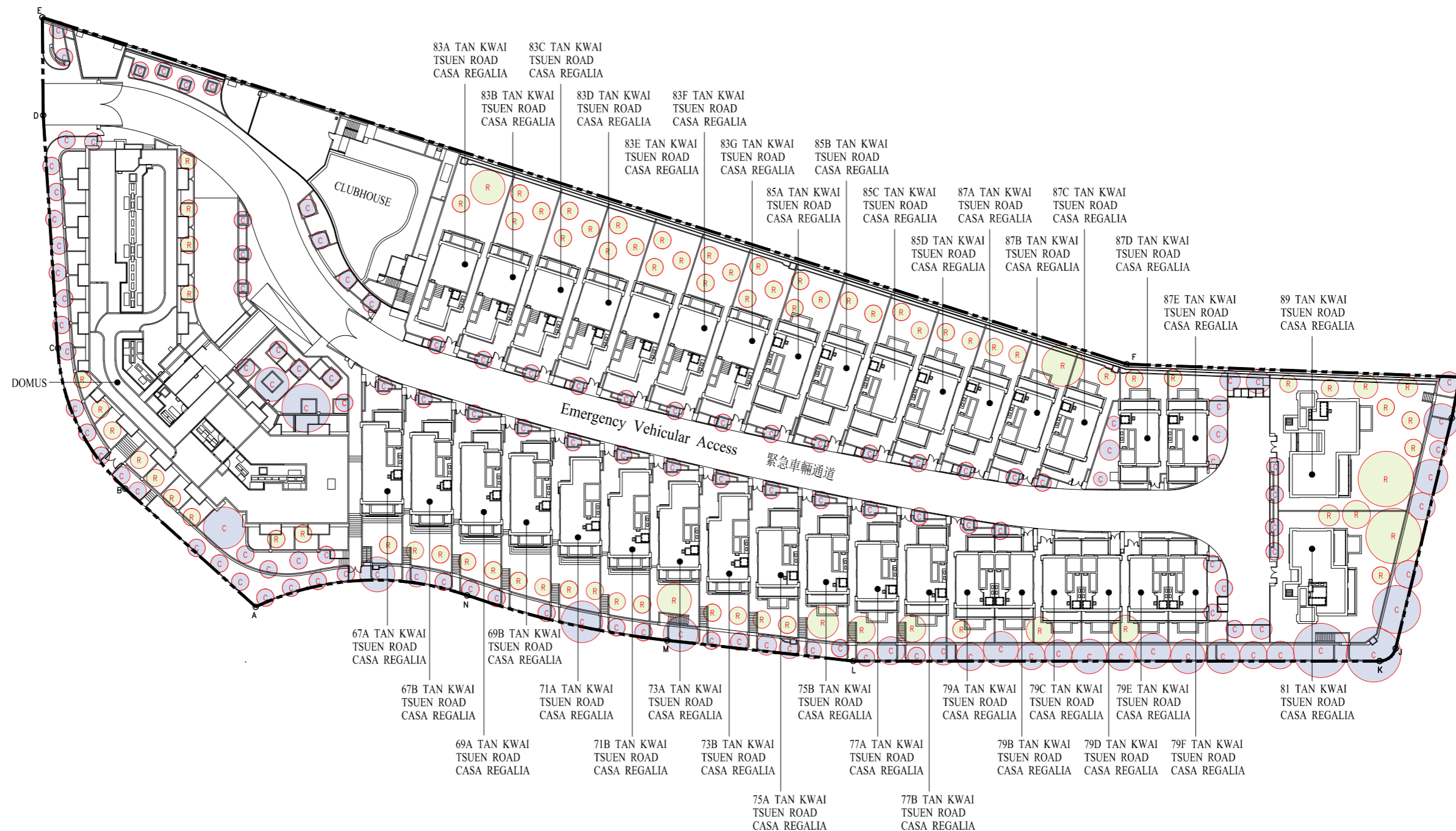

LEGEND
圖例

--- Site Boundary
物業邊界線

 Trees in the Common Areas of the Development
於發展項目公用地方的樹

 Trees within the Gardens of Residential Properties
於住宅物業花園的樹

The last updated version of the Tree Compensation Plan approved by the District Lands Office, Yuen Long, Lands Department as of the date of printing of the sales brochure is available for free inspection during normal office hours at the sales office.

在印製售樓說明書當日適用的最近更新版本經地政總署元朗地政處批准的樹木補償方案示意圖存於售樓處，於正常辦公時間內供免費查閱。

RELEVANT INFORMATION 有關資料

Tree Compensation Plan (Roof Floor Plan)
樹木補償方案示意圖 (天台平面圖)

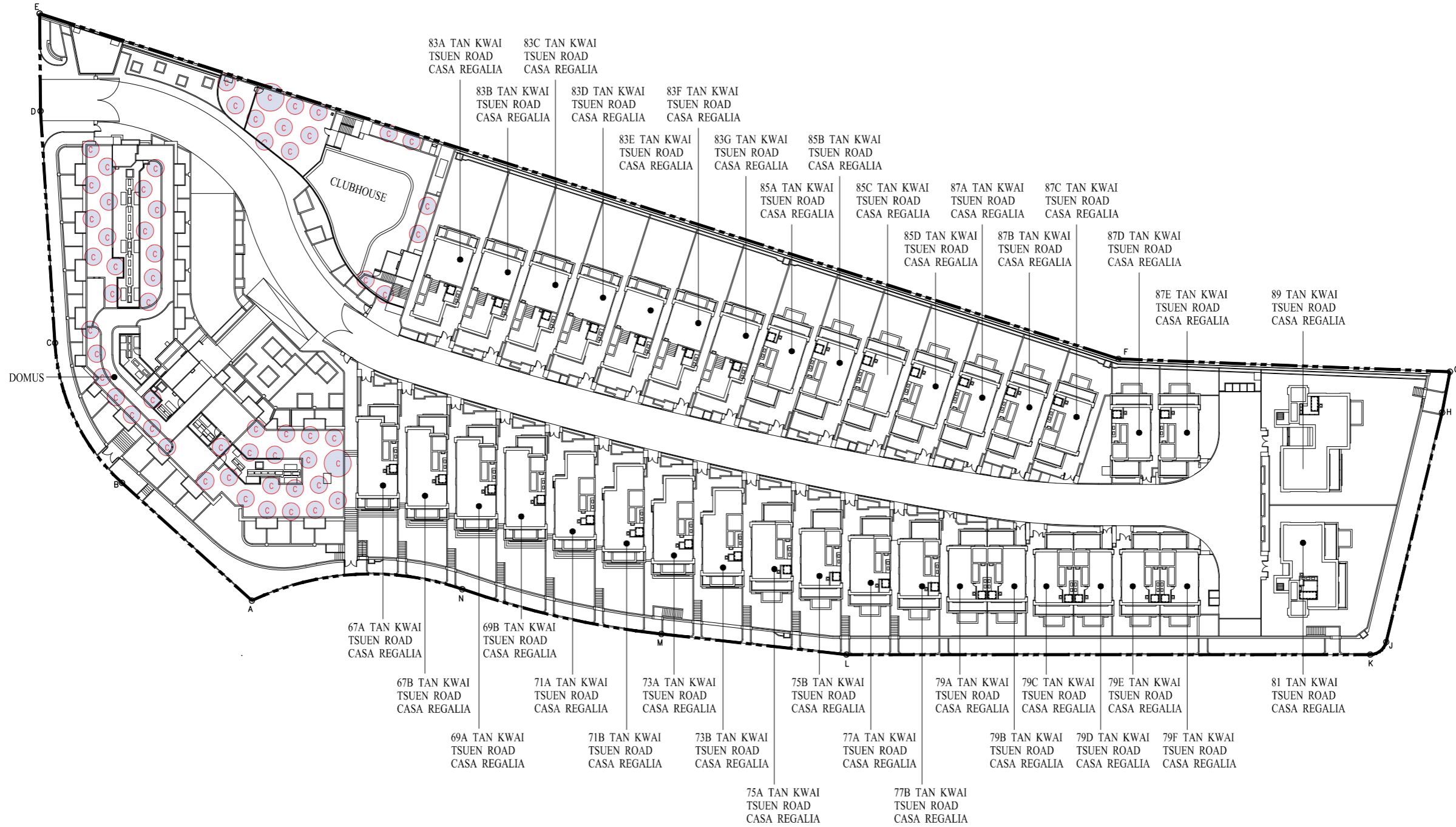

LEGEND

- 圖例
-  Site Boundary
物業邊界線
 -  Trees in the Common Areas of the Development
於發展項目公用地方的樹

The last updated version of the Tree Compensation Plan approved by the District Lands Office, Yuen Long, Lands Department as of the date of printing of the sales brochure is available for free inspection during normal office hours at the sales office.

在印製售樓說明書當日適用的最近更新版本經地政總署元朗地政處批准的樹木補償方案示意圖存於售樓處，於正常辦公時間內供免費查閱。

The address of the website designated by the vendor for the Development for the purposes of Part 2 of the Residential Properties (First-hand Sales) Ordinance:

www.casaregalia.hk

賣方為施行《一手住宅物業銷售條例》第2部而就發展項目指定的互聯網網站的網址：

www.casaregalia.hk

INFORMATION IN APPLICATION FOR CONCESSION ON GROSS FLOOR AREA OF BUILDING

申請建築物總樓面面積寬免的資料

Breakdown of GFA Concessions Obtained of All Features

Latest information on breakdown of GFA concessions as shown on the general building plans submitted to and approved by the Building Authority (BA) prior to the printing of the sales brochure is tabulated below. Information marked (#) may be based on information provided by the authorized person if the sales brochure is printed prior to submission of the final amendment plans to the BA. The breakdown of GFA concessions may be subject to further changes until final amendment plans are submitted to and approved by the BA prior to the issuance of the occupation permit for the development.

		Area(m ²) 面積 (平方米)
Disregarded GFA under Building (Planning) Regulations 23(3)(b) 根據《建築物(規劃)規例》第23(3)(b)條不計算的總樓面面積		
1.(#)	Carpark and loading/unloading area excluding public transport terminus 停車場及上落客貨地方(公共交通總站除外)	3207.345
2.	Plant rooms and similar services 機房及相類設施	
2.1	Mandatory feature or essential plant room, area of which is limited by respective Practice Notes for Authorized Persons, Registered Structural Engineers and Registered Geotechnical Engineers (PNAP) or regulation such as lift machine room, telecommunications and broadcasting (TBE) room, refuse storage and material recovery chamber, etc. 所佔面積受相關《認可人士、註冊結構工程師及註冊岩土工程師作業備考》或規例限制的強制性設施或必要機房, 例如升降機機房、電訊及廣播設備室、垃圾及物料回收房等	68.263
2.2(#)	Mandatory feature or essential plant room, area of which is NOT limited by any PNAP or regulation such as room occupied solely by fire services installations (FSI) and equipment, meter room, transformer room, potable and flushing water tank, etc. 所佔面積不受任何《認可人士、註冊結構工程師及註冊岩土工程師作業備考》或規例限制的強制性設施或必要機房, 例如僅供消防裝置及設備佔用的房間、電錶房、電力變壓房、食水及鹹水缸等	1681.749
2.3	Non-mandatory or non-essential plant room such as air-conditioning plant room, air handling unit (AHU) room, etc. 非強制性或非必要機房, 例如空調機房、風櫃房等	44.254
Green Features under Joint Practice Notes 1 and 2 根據聯合作業備考第1及第2號提供的環保設施		
3.	Balcony 露台	391.269
4.	Wider common corridor and lift lobby 加闊的公用走廊及升降機大堂	51.000
5.	Communal sky garden 公用空中花園	Not Applicable 不適用
6.	Acoustic fin 隔聲鱗	Not Applicable 不適用
7.	Wing wall, wind catcher and funnel 翼牆、捕風器及風斗	Not Applicable 不適用
8.	Non-structural prefabricated external wall 非結構預製外牆	108.312
9.	Utility platform 工作平台	Not Applicable 不適用
10.	Noise barrier 隔音屏障	Not Applicable 不適用

獲寬免總樓面面積的設施分項

於印製售樓說明書前呈交予並已獲建築事務監督批准的一般建築圖則上有關總樓面面積寬免的分項的最新資料, 請見下表。如印製售樓說明書時尚未呈交最終修訂圖則予建築事務監督, 則有(#)號的資料可以由認可人士提供的資料作為基礎。直至最終修訂圖則於發出佔用許可證前呈交予並獲建築事務監督批准前, 以下分項資料仍可能有所修改。

		Area(m ²) 面積 (平方米)
Amenity Features 適意設施		
11.	Counter, office, store, guard room and lavatory for watchman and management staff, Owners' Corporation Office 供保安人員和管理處員工使用的櫃檯、辦公室、儲物室、警衛室和廁所、業主立案法團辦公室	35.631
12.	Residential Recreational facilities including void, plant room, swimming pool filtration plant room, covered walkway etc serving solely the recreational facilities 住宅康樂設施, 包括僅供康樂設施使用的中空、機房、游泳池的濾水器機房、有蓋人行道等	396.615
13.	Covered landscaped and play area 有上蓋的園景區及遊樂場	Not Applicable 不適用
14.	Horizontal screens/covered walkways, trellis 橫向屏障/有蓋人行道、花棚	7.345
15.	Larger lift shaft 擴大升降機井道	Not Applicable 不適用
16.	Chimney shaft 煙囪管道	Not Applicable 不適用
17.	Other non-mandatory or non-essential plant room, such as boiler room, satellite master antenna television (SMATV) room. 其他非強制性或非必要機房, 例如鍋爐房、衛星電視共用天線房	1.305
18.(#)	Pipe duct, air duct for mandatory feature or essential plant room 強制性設施或必要機房所需的管槽、氣槽	12.421
19.	Pipe duct, air duct for non-mandatory or non-essential plant room 非強制性設施或非必要機房所需的管槽、氣槽	52.923
20.	Plant room, pipe duct, air duct for environmentally friendly system and feature. 環保系統及設施所需的機房、管槽及氣槽	Not Applicable 不適用
21.	Void in duplex domestic flat and house 複式住宅單位及洋房的中空	10.217
22.	Projections such as air-conditioning box and platform with a projection of more than 750 mm from the external wall. 伸出物, 如空調機箱及伸出外牆超過750毫米的平台	Not Applicable 不適用
Other Exempted Items 其他項目		
23.(#)	Refuge floor including refuge floor cum sky garden 庇護層, 包括庇護層兼空中花園	Not Applicable 不適用

		Area(m ²) 面積 (平方米)
Other Exempted Items 其他項目		
24.([†])	Other projections 其他伸出物	34.176
25.	Public transport terminus 公共交通總站	Not Applicable 不適用
26.([†])	Party structure and common staircase 共用構築物及樓梯	Not Applicable 不適用
27.([†])	Horizontal area of staircase, lift shaft and vertical duct solely serving floor accepted as not being accountable for GFA. 僅供獲接納不計入總樓面面積的樓層使用的樓梯、升降機槽及垂直管道的水平面積	Not Applicable 不適用
28.([†])	Public passage 公眾通道	Not Applicable 不適用
29.	Covered set back area 因建築物後移導致的覆蓋面積	Not Applicable 不適用
Bonus GFA 額外總樓面面積		
30.	Bonus GFA 額外總樓面面積	Not Applicable 不適用

Notes:

The above table is based on the requirements as stipulated in the Practice Note for Authorized Persons, Registered Structural Engineers and Registered Geotechnical Engineers ADM-2 issued by the Buildings Department. The Buildings Department may revise such requirements from time to time as appropriate.

備註：

上述表格是根據屋宇署所發出的《認可人士、註冊結構工程師及註冊岩土工程師作業備考》ADM-2規定的要求而制訂的。屋宇署會按實際需要不時更改有關要求。

Environmental Assessment of the Building

Green Building Certification

Assessment result under the **BEAM Plus** certification conferred / issued by Hong Kong Green Building Council Limited (HKGBC) for the building prior to the printing of the sales brochures.

FINAL RATING
UNCLASSIFIED



Application no.: FAU0001/17

建築物的環境評估

綠色建築認證

在印刷此售樓說明書前，本物業根據香港綠色建築議會有限公司頒授 / 發出的綠建環評認證評級。

最終評級
不予評級



申請編號: FAU0001/17

INFORMATION IN APPLICATION FOR CONCESSION ON GROSS FLOOR AREA OF BUILDING

申請建築物總樓面面積寬免的資料

Environmental assessment and information on the estimated energy performance or consumption for the common parts of the Development

Latest information on the estimated energy performance or consumption for the common parts of the development as submitted to the Building Authority prior to the printing of the sales brochures:

Part I	
Provision of Central Air Conditioning	*YES / NØ
Provision of Energy Efficient Features	*YES / NØ
Energy Efficient Features proposed:	1. Daylight control devices are provided within the development 2. High performance VRV with COP at least 3 are provided within the development 3. Window-to-wall ration less than 65% of baseline building

Part II : The predicted annual energy use of the proposed building / part of building ^(Note 1)					
Location	Internal Floor Area Served ^(m²)	Annual Energy Use of Baseline Building ^(Note 2)		Annual Energy Use of Proposed Building	
		Electricity kWh/ m ² /annum	Town Gas / LPG unit/ m ² /annum	Electricity kWh/ m ² /annum	Town Gas / LPG unit/ m ² /annum
Area served by central building services installation ^(Note 3)	974.234	372.237	N/A	330.321	N/A

Part III : The following installation(s) is / are* designed in accordance with the relevant Codes of Practices published by the Electrical & Mechanical Services Department (EMSD)			
Type of Installations	YES	NO	N/A
Lighting Installations	✓		
Air Conditioning Installations	✓		
Electrical Installations	✓		
Lift & Escalator Installations	✓		
Performance-based Approach			✓

Notes:

- In general, the lower the estimated “Annual Energy Use” of the building, the more efficient of the building in terms of energy use. For example, if the estimated “annual energy use of proposed building” is less than the estimated “annual energy use of baseline building”, it means the predicted use of energy is more efficient in the proposed building than in the baseline building. The larger the reduction, the greater the efficiency. The predicted annual energy use, in terms of electricity consumption (kWh/m²/annum) and town gas/LPG consumption (unit/m²/annum), of the development by the internal floor area served, where: (a) “total annual energy use” has the same meaning of “annual energy use” under Section 4 and Appendix 8 of the BEAM Plus for New Buildings (current version); and (b) “internal floor area”, in relation a building, a space or a unit means the floor area of all enclosed space measured to the internal faces of enclosing external and/or party walls.
- “Baseline Building” has the same meaning as “Baseline Building Model (zero-credit benchmark)” under Section 4 and Appendix 8 of the BEAM Plus for New Building (current version).
- “Central Building Services Installation” has the same meaning as that in the Code of Practice for Energy Efficiency of Building Services Installations in Buildings (February 2010 edition) (Draft).

Please (✓) where appropriate

* Delete as appropriate

發展項目的公用部分的預計能量表現或消耗

於印製售樓說明書前呈交予建築事務監督發展項目的公用部份的預計能量表現或消耗的最近期資料：

第I部分	
提供中央空調	* 是 / 否
提供具能源效益的設施	* 是 / 否
擬安裝的具能源效益的設施:-	1. 項目設有日光控制設備 2. 項目設有性能係數3或以上的高效能多聯或變頻冷氣機 3. 窗與牆的比例少於基準樓宇百分之六十五

第II部分：擬興建樓宇/部分樓宇預計每年能源消耗量 (註腳1) :-					
位置	使用有關裝置的內部樓面面積 (平方米)	基線樓宇每年能源消耗量 (註腳2)		擬興建樓宇每年能源消耗量	
		電力 千瓦小時/平方米/年	煤氣/石油氣 用量單位/平方米/年	電力 千瓦小時/平方米/年	煤氣/石油氣 用量單位/平方米/年
有使用中央屋宇裝備裝置(註腳3)的部分	974.234	372.237	N/A	330.321	N/A

第III部分：以下裝置乃按機電工程署公布的相關實務守則設計:-			
裝置類型	是	否	不適用
照明裝置	✓		
空調裝置	✓		
電力裝置	✓		
升降機及自動梯的裝置	✓		
以總能源為本的方法			✓

備註：

- 一般而言，一棟樓宇的預計“每年能源消耗量”愈低，其節約能源的效益愈高。如一棟樓宇預計的“每年能源消耗量”低於該樓宇的“基線樓宇每年能源消耗量”，則代表預計該樓宇的能源應用較其基線樓宇有效，削減幅度愈大則代表有關樓宇能源節約的效益愈高。
預計每年能源消耗量[以耗電量(千瓦小時/平方米/年)及煤氣/石油氣消耗量(用量單位/平方米/年)計算]，指將發展項目的每年能源消耗總量除以使用有關裝置的內部樓面面積所得出的商，其中:-
(a) “每年能源消耗量”與新建樓宇BEAM Plus標準(現行版本)第4節及附錄8中的「年能源消耗」具有相同涵義；及
(b) 樓宇、空間或單位的“內部樓面面積”，指外牆及/或共用牆的內壁之內表面起量度出來的樓面面積。
- “基準樓宇”與新建樓宇BEAM Plus標準(現行版本)第4節及附錄8中的“基準建築物模式(零分標準)”具有相同涵義。
- “中央屋宇裝備裝置”與樓宇的屋宇裝備裝置能源效益實務守則(2010年2月版)(草稿)中的涵義相同。

請在適當情況下(✓)

* 請刪去不適用

This page is deleted and replaced with a blank page.
刪除此頁並換上空頁。

Examination / Revision Date 檢視日期	Revision Made 所作修改	
	Page Number 頁次	Revision Made 所作修改
27 May 2015 2015年5月27日	Front Cover 封面	Cover Design is updated 更新封面設計
1 June 2015 2015年6月1日	Page 230 第230頁	Tree Compensation Plan (Ground Floor Plan) is updated 更新樹木補償方案示意圖 (地下平面圖)
3 June 2015 2015年6月3日	Page 184 第184頁	The Appliance Schedule for Domus is updated 更新尚築設備說明表
12 January 2016 2016年1月12日	Page 13 第13頁	Location Plan is updated 更新所在位置圖
	Page 14 第14頁	Aerial Photograph is updated 更新鳥瞰照片
	Page 16 - 17 第16 - 17頁	Outline Zoning Plan is updated 更新分區計劃大綱圖
	Page 18 第18頁	The estimated date of completion of the building or facilities of the Development as provided by the Authorized Person for the Development is deleted 刪除認可人士提供的發展項目的該等建築物或設施的預計落成日期 Layout plan is updated 更新布局圖
	Page 25 - 96 第25 - 96頁	Floor plans are revised 修訂平面圖
	Page 109 - 110 第109 - 110頁	The provisions under floor plans of parking spaces in the Development are revised 修改發展項目中的停車位的樓面平面圖之內容 The provisions in the table of number and area of parking spaces are revised 修改停車位數目及面積表格之內容
	Page 132 第132頁	Key plan is updated 更新索引圖
	Page 140 - 141 第140 - 141頁	Elevations are revised 修訂立面圖
	Page 195 - 198, 200 - 208, 210 - 215, 217, 218, 220 - 225 第195 - 198, 200 - 208, 210 - 215, 217, 218, 220 - 225頁	The provisions under Fittings, Finishes and Appliances are revised 修訂裝置、裝修物料及設備之內容
	Page 230 - 231 第230 - 231頁	The Tree Compensation Plans (Ground Floor Plan and Roof Floor Plan) are revised 修訂樹木補償方案示意圖 (地下平面圖及天台平面圖)
	Page 232 第232頁	The address of the website designated for the Development is updated 更新就發展項目指定的互聯網網站的網址
Page 233 第233頁	Information in application for concession on gross floor area of building is revised 修訂申請建築物總樓面面積寬免的資料	
Page 235 - 236 第235 - 236頁	Environmental assessment and information on the estimated energy performance or consumption for the common parts of the Development are revised 修訂發展項目的公用部份的預計能量表現或消耗	

EXAMINATION RECORD

檢視記錄

Examination / Revision Date 檢視日期	Revision Made 所作修改	
	Page Number 頁次	Revision Made 所作修改
24 February 2016 2016年2月24日	Page 6 第6頁	The estimated material date for the Development, as provided by the authorized person for the Development, are revised 修改由發展項目的認可人士提供的該發展項目的預計關鍵日期
	Page 62 第62頁	2/F plan is revised 修訂二樓平面圖
22 April 2016 2016年4月22日	Page 6 第6頁	The estimated material date for the Development, as provided by the authorized person for the Development, are revised 修改由發展項目的認可人士提供的該發展項目的預計關鍵日期
	Page 13 第13頁	Location Plan is updated 更新所在位置圖
11 May 2016 2016年5月11日	Page 6 第6頁	The estimated material date for the Development, as provided by the authorized person for the Development, are delete 刪除由發展項目的認可人士提供的該發展項目的預計關鍵日期
	Page 33, 34, 41, 42, 65 and 66 第33, 34, 41, 42, 65及66頁	Remarks are added on Floor Plans 在平面圖加上備註
	Page 34A, 34B, 42A, 42B, 66A and 66B (additional pages) 第34A, 34B, 42A, 42B, 66A及66B頁 (加頁)	"as-is" Layout Plans are added 加上"現狀"平面圖
	Page 63, 79, 81 and 83 第63, 79, 81及83頁	Floor Plans are revised 修改平面圖
	Page 152 - 159, 168 - 171, 181, 195 - 212 and 214 Page 155A, 155B, 155C, 155D, 159A, 159B, 159C, 159D, 171A, 171B, 171C, 171D (additional pages) 第152 - 159, 168 - 171, 181, 195 - 212及214頁 第155A, 155B, 155C, 155D, 159A, 159B, 159C, 159D, 171A, 171B, 171C, 171D頁 (加頁)	The provisions under Fittings, Finishes and Appliances are revised 修訂裝置、裝修物料及設備之內容
10 August 2016 2016年8月10日	Page 186 and 200 第186及200頁	The provisions under Fittings, Finishes and Appliances are revised 修訂裝置、裝修物料及設備之內容
8 November 2016 2016年11月8日	Page 13 第13頁	Location Plan is updated 更新所在位置圖
8 February 2017 2017年2月8日	Page 13 第13頁	Location Plan is updated 更新所在位置圖
	Page 237 第237頁	Page 237 is deleted and replaced with blank page. 刪除第237頁並換上空頁

Examination / Revision Date 檢視日期	Revision Made 所作修改	
	Page Number 頁次	Revision Made 所作修改
5 May 2017 2017年5月5日	Page 9 第9頁	Information on design of the Development is revised 修改發展項目的設計的資料
	Page 12 第12頁	Information on property management is revised 修改物業管理的資料
	Page 13 第13頁	Location Plan is updated 更新所在位置圖
	Page 112, 114, 115 and 117 第112, 114, 115及117頁	Summary of Deed of Mutual Covenant is revised 修改公契的摘要
	Page 143 第143頁	Inspection of plans and deed of mutual covenant is revised 修改閱覽圖則及公契
	Page 226 第226頁	Government Rent is revised 修改地稅
	Page 229 第229頁	Relevant information is revised 修改有關資料
4 August 2017 2017年8月4日	Page 7 第7頁	Information on Vendor and Others Involved in the Development is revised 修改賣方及有參與發展項目的其他人的資料
	Page 13 第13頁	Location Plan is updated 更新所在位置圖
	Page 16 - 17 第16 - 17頁	Outline Zoning Plan is updated 更新分區計劃大綱圖
3 November 2017 2017年11月3日	Page 2A and 2B (additional pages) 第2A及2B頁 (加頁)	Notes to Purchasers of First-Hand Residential Properties is updated 更新一手住宅物業買家須知
	Page 13 第13頁	Location Plan is updated 更新所在位置圖
	Page 14 第14頁	Aerial Photograph of the Development is updated 更新發展項目的鳥瞰照片
	Page 15 第15頁	Outline Zoning Plan is updated 更新分區計劃大綱圖
	Page 234 第234頁	Information in Application for Concession on Gross Floor Area of Building is updated 更新申請建築物總樓面面積寬免的資料
2 February 2018 2018年2月2日	Page 13 第13頁	Location Plan is updated 更新所在位置圖
	Page 14, <14A, 14B, 14C and 14D (additional pages)> 第14頁、<14A頁、14B頁、14C頁及14D頁(加頁)>	Aerial Photograph of the Development is updated 更新發展項目的鳥瞰照片

Examination / Revision Date 檢視日期	Revision Made 所作修改	
	Page Number 頁次	Revision Made 所作修改
27 April 2018 2018年4月27日	Page 13 第13頁	Location Plan is updated 更新所在位置圖
26 July 2018 2018年7月26日	Page 7 第7頁	Information on Vendor and Others Involved in the Development is revised 修改賣方及有參與發展項目的其他人的資料
	Page 13 第13頁	Location Plan is updated 更新所在位置圖
	Page 14, 14A, 14B, 14C 第14、14A、14B、14C頁	Aerial Photograph is updated 更新鳥瞰照片

There may be future changes to the Development and the surrounding areas.
發展項目及其周邊地區日後可能出現改變。

