



EDEN MANOR

高爾夫 · 御苑

售樓說明書

Sales Brochure

	一手住宅物業買家須知 NOTES TO PURCHASERS OF FIRST-HAND RESIDENTIAL PROPERTIES	P. 2			
1	發展項目高爾夫·御苑的資料 INFORMATION ON THE DEVELOPMENT, EDEN MANOR	P. 7	16	公共設施及公眾休憩用地的資料 INFORMATION ON PUBLIC FACILITIES AND PUBLIC OPEN SPACES	P. 190
2	賣方及有參與發展項目的其他人的資料 INFORMATION ON VENDOR AND OTHERS INVOLVED IN THE DEVELOPMENT	P. 8	17	對買方的警告 WARNING TO PURCHASERS	P. 195
3	有參與發展項目的各方的關係 RELATIONSHIP BETWEEN PARTIES INVOLVED IN THE DEVELOPMENT	P. 9	18	發展項目中的建築物的橫截面圖 CROSS-SECTION PLAN OF BUILDING IN THE DEVELOPMENT	P. 196
4	發展項目的設計的資料 INFORMATION ON DESIGN OF THE DEVELOPMENT	P. 11	19	立面圖 ELEVATION PLAN	P. 207
5	物業管理的資料 INFORMATION ON PROPERTY MANAGEMENT	P. 13	20	發展項目中的公用設施的資料 INFORMATION ON COMMON FACILITIES IN THE DEVELOPMENT	P. 219
6	發展項目的所在位置圖 LOCATION PLAN OF THE DEVELOPMENT	P. 14	21	閱覽圖則及公契 INSPECTION OF PLANS AND DEED OF MUTUAL COVENANT	P. 219
7	發展項目的鳥瞰照片 AERIAL PHOTOGRAPH OF THE DEVELOPMENT	P. 15	22	裝置、裝修物料及設備 FITTINGS, FINISHES AND APPLIANCES	P. 220
8	關乎發展項目的分區計劃大綱圖等 OUTLINE ZONING PLAN ETC. RELATING TO THE DEVELOPMENT	P. 16	23	服務協議 SERVICE AGREEMENTS	P. 280
9	發展項目的布局圖 LAYOUT PLAN OF THE DEVELOPMENT	P. 19	24	地稅 GOVERNMENT RENT	P. 280
10	發展項目的住宅物業的樓面平面圖 FLOOR PLANS OF RESIDENTIAL PROPERTIES IN THE DEVELOPMENT	P. 20	25	買方的雜項付款 MISCELLANEOUS PAYMENTS BY PURCHASER	P. 281
11	發展項目中的住宅物業的面積 AREA OF RESIDENTIAL PROPERTIES IN THE DEVELOPMENT	P. 162	26	欠妥之處的保養責任期 DEFECT LIABILITY WARRANTY PERIOD	P. 281
12	發展項目中的停車位的樓面平面圖 FLOOR PLANS OF PARKING SPACES IN THE DEVELOPMENT	P. 170	27	斜坡維修 MAINTENANCE OF SLOPES	P. 282
13	臨時買賣合約的摘要 SUMMARY OF PRELIMINARY AGREEMENT FOR SALE AND PURCHASE	P. 173	28	修訂 MODIFICATION	P. 282
14	公契的摘要 SUMMARY OF DEED OF MUTUAL COVENANT	P. 174	29	申請建築物總樓面面積寬免的資料 INFORMATION IN APPLICATION FOR CONCESSION ON GROSS FLOOR AREA OF BUILDING	P. 283
15	批地文件的摘要 SUMMARY OF LAND GRANT	P. 178	30	有關資料 RELEVANT INFORMATION	P. 287
				地政總署署長作為給予預售樓花同意書的條件而規定列於售樓說明書的一些資料 SOME INFORMATION REQUIRED BY THE DIRECTOR OF LANDS TO BE SET OUT IN THE SALES BROCHURE AS A CONDITION FOR GIVING THE PRESALE CONSENT	P. 293

您在購置一手住宅物業之前，應留意下列事項：

適用於所有一手住宅物業

1. 重要資訊

- 瀏覽一手住宅物業銷售資訊網（下稱「銷售資訊網」）（網址：www.srpe.gov.hk），參考「銷售資訊網」內有關一手住宅物業的市場資料。
- 閱覽賣方就該發展項目所指定的互聯網網站內的有關資訊，包括售樓說明書、價單、載有銷售安排的文件，及成交紀錄冊。
- 發展項目的售樓說明書，會在該項目的出售日期前最少七日向公眾發布，而有關價單和銷售安排，亦會在該項目的出售日期前最少三日公布。
- 在賣方就有關發展項目所指定的互聯網網站，以及「銷售資訊網」內，均載有有關物業成交資料的成交紀錄冊，以供查閱。

2. 費用、按揭貸款和樓價

- 計算置業總開支，包括律師費、按揭費用、保險費，以及印花稅。
- 向銀行查詢可否取得所需的按揭貸款，然後選擇合適的還款方式，並小心計算按揭貸款金額，以確保貸款額沒有超出本身的負擔能力。
- 查閱同類物業最近的成交價格，以作比較。
- 向賣方或地產代理瞭解，您須付予賣方或該發展項目的管理人的預計的管理費、管理費上期金額（如有）、特別基金金額（如有）、補還的水、電力及氣體按金（如有）、以及 / 或清理廢料的費用（如有）。

3. 價單、支付條款，以及其他財務優惠

- 賣方未必會把價單所涵蓋的住宅物業悉數推售，因此應留意有關的銷售安排，以了解賣方會推售的住宅物業為何。賣方會在有關住宅物業推售日期前最少三日公布銷售安排。
- 留意價單所載列的支付條款。倘買家可就購置有關住宅物業而連帶獲得價格折扣、贈品，或任何財務優惠或利益，上述資訊亦會在價單內列明。
- 如您擬選用由賣方指定的財務機構提供的各類按揭貸款計劃，在簽訂臨時買賣合約前，應先細閱有關價單內列出的按揭貸款計劃資料¹。如就該些按揭貸款計劃的詳情有任何疑問，應在簽訂臨時買賣合約前，直接向有關財務機構查詢。

4. 物業的面積及四周環境

- 留意載於售樓說明書和價單內的物業面積資料，以及載於價單內的每平方呎 / 每平方米售價。根據《一手住宅物業銷售條例》（第 621 章）（下稱「條例」），賣方只可以實用面積表達住宅物業的面積和每平方呎及平方米的售價。就住宅物業而言，實用面積指該住宅物業的樓面面積，包括在構成該物業的一部分的範圍內的以下每一項目的樓面面積：(i) 露台；(ii) 工作平台；以及 (iii) 陽台。實用面積並不包括空調機房、窗台、閣樓、平台、花園、停車位、天台、梯屋、前庭或庭院的每一項目的面積，即使該些項目構成該物業的一部分的範圍。

- 售樓說明書必須顯示發展項目中所有住宅物業的樓面平面圖。在售樓說明書所載有關發展項目中住宅物業的每一份樓面平面圖，均須述明每個住宅物業的外部及內部尺寸²。售樓說明書所提供有關住宅物業外部及內部的尺寸，不會把批盪和裝飾物料包括在內。買家收樓前如欲購置家具，應留意這點。
- 親臨發展項目的所在地實地視察，以了解有關物業的四周環境（包括交通和社區設施）；亦應查詢有否任何城市規劃方案和議決，會對有關的物業造成影響；參閱載於售樓說明書內的位置圖、鳥瞰照片、分區計劃大綱圖，以及橫截面圖。

5. 售樓說明書

- 確保所取得的售樓說明書屬最新版本。根據條例，提供予公眾的售樓說明書必須是在之前的三個月之內印製或檢視、或檢視及修改。
- 閱覽售樓說明書，並須特別留意以下資訊：
 - 售樓說明書內有否關於「有關資料」的部分，列出賣方知悉但並非為一般公眾人士所知悉，關於相當可能對享用有關住宅物業造成重大影響的事宜的資料。請注意，已在土地註冊處註冊的文件，其內容不會被視為「有關資料」；
 - 橫截面圖會顯示有關建築物相對毗連該建築物的每條街道的橫截面，以及每條上述街道與已知基準面和該建築物最低的一層住宅樓層的水平相對的水平。橫截面圖能以圖解形式，顯示出建築物最低一層住宅樓層和街道水平的高低差距，不論該最低住宅樓層以何種方式命名；
 - 室內和外部的裝置、裝修物料和設備；
 - 管理費按甚麼基準分擔；
 - 小業主有否責任或需要分擔管理、營運或維持有關發展項目以內或以外的公眾休憩用地或公共設施的開支，以及有關公眾休憩用地或公共設施的位置；以及
 - 小業主是否須要負責維修斜坡。

6. 政府批地文件和公契

- 閱覽政府批地文件和公契（或公契擬稿）。公契內載有天台和外牆業權等相關資料。賣方會在售樓處提供政府批地文件和公契（或公契擬稿）的複本，供準買家免費閱覽。
- 留意政府批地文件內所訂明小業主是否須要負責支付地稅。
- 留意公契內訂明有關物業內可否飼養動物。

7. 售樓處內有關可供揀選住宅物業的資料

- 向賣方查詢清楚有哪些一手住宅物業可供揀選。若賣方在售樓處內展示「消耗表」，您可從該「消耗表」得悉在每個銷售日的銷售進度資料，包括在該個銷售日開始時有哪些住宅物業可供出售，以及在該個銷售日內有哪些住宅物業已獲揀選及售出。
- 切勿隨便相信有關發展項目銷情的傳言，倉卒簽立臨時買賣合約。

8. 成交紀錄冊

- 留意發展項目的成交紀錄冊。賣方須於臨時買賣合約訂立後的 24 小時內，於紀錄冊披露該臨時買賣合約的資料，以及於買賣合約訂立後一個工作天內，披露該買賣合約的資料。您可透過成交紀錄冊得悉發展項目的銷售情況。
- 切勿將賣方接獲用作登記的購樓意向書或本票的數目視為銷情指標。發展項目的成交紀錄冊才是讓公眾掌握發展項目每日銷售情況的最可靠資料來源。

9. 買賣合約

- 確保臨時買賣合約和買賣合約包含條例所規定的強制性條文。
- 留意有關物業買賣交易所包括的裝置、裝修物料和設備，須在臨時買賣合約和買賣合約上列明。
- 留意夾附於買賣合約的圖則。該圖則會顯示所有賣方售予您的物業面積，而該面積通常較該物業的實用面積為大。
- 訂立臨時買賣合約時，您須向擁有人（即賣方）支付樓價 5% 的臨時訂金。
- 如您在訂立臨時買賣合約後五個工作日（工作日指並非公眾假日、星期六、黑色暴雨警告日或烈風警告日的日子）之內，沒有簽立買賣合約，該臨時買賣合約即告終止，有關臨時訂金（即樓價的 5%）會被沒收，而擁有人（即賣方）不得因您沒有簽立買賣合約而對您提出進一步申索。
- 在訂立臨時買賣合約後的五個工作日之內，倘您簽立買賣合約，則擁有人（即賣方）必須在訂立該臨時買賣合約後的八個工作日之內簽立買賣合約。
- 有關的訂金，應付予負責為所涉物業擔任保證金保存人的律師事務所。

10. 表達購樓意向

- 留意在賣方（包括其獲授權代表）就有關住宅物業向公眾提供價單前，賣方不得尋求或接納任何對有關住宅物業的購樓意向（不論是否屬明確選擇購樓意向）。因此您不應向賣方或其授權代表提出有關意向。
- 留意在有關住宅物業的銷售開始前，賣方（包括其獲授權代表）不得尋求或接納任何對該物業的有明確選擇購樓意向。因此您不應向賣方或其授權代表提出有關意向。

11. 委託地產代理

- 留意倘賣方委任一個或多於一個地產代理，以協助銷售其發展項目內任何指明住宅物業，該發展項目的價單必須列明在價單印刷日期當日所有獲委任為地產代理的姓名 / 名稱。
- 您可委託任何地產代理（不一定是賣方所指定的地產代理），以協助您購置發展項目內任何指明住宅物業；您亦可不委託任何地產代理。
- 委託地產代理以物色物業前，您應該 —
 - 了解該地產代理是否只代表您行事。該地產代理若同時代表賣方行事，倘發生利益衝突，未必能夠保障您的最大利益；

- 了解您須否支付佣金予該地產代理。若須支付，有關的佣金金額和支付日期為何；以及
- 留意只有持牌地產代理或營業員才可以接受您的委託。如有疑問，應要求該地產代理或營業員出示其「地產代理證」，或瀏覽地產代理監管局的網頁（網址：www.eaa.org.hk），查閱牌照目錄。

12. 委聘律師

- 考慮自行委聘律師，以保障您的利益。該律師若同時代表賣方行事，倘發生利益衝突，未必能夠保障您的最大利益。
- 比較不同律師的收費。

適用於一手未落成住宅物業

13. 預售樓花同意書

- 洽購地政總署「預售樓花同意方案」下的未落成住宅物業時，應向賣方確認地政總署是否已就該發展項目批出「預售樓花同意書」。

14. 示範單位

- 賣方不一定須設置示範單位供準買家或公眾參觀，但賣方如為某指明住宅物業設置示範單位，必須首先設置該住宅物業的無改動示範單位，才可設置該住宅物業的經改動示範單位，並可以就該住宅物業設置多於一個經改動示範單位。
- 參觀示範單位時，務必視察無改動示範單位，以便與經改動示範單位作出比較。然而，條例並沒有限制賣方安排參觀無改動示範單位及經改動示範單位的先後次序。
- 賣方設置示範單位供公眾參觀時，應已提供有關發展項目的售樓說明書。因此，緊記先行索取售樓說明書，以便在參觀示範單位時參閱相關資料。
- 您可以在無改動示範單位及經改動示範單位中進行量度，並在無改動示範單位內拍照或拍攝影片，惟在確保示範單位參觀者人身安全的前提下，賣方可能會設定合理的限制。

適用於一手未落成住宅物業及尚待符合條件的已落成住宅物業

15. 預計關鍵日期及收樓日期

- 查閱售樓說明書中有關發展項目的預計關鍵日期³。
 - 售樓說明書中有關發展項目的預計關鍵日期並不同買家的「收樓日期」。買家的「收樓日期」必定較發展項目的預計關鍵日期遲。
- 收樓日期
 - 條例規定買賣合約須載有強制性條文，列明賣方須於買賣合約內列出的預計關鍵日期後的 14 日內，以書面為發展項目申請佔用文件、合格證明書，或地政總署署長的轉讓同意（視屬何種情況而定）。

- 如發展項目屬地政總署預售樓花同意方案所規管，賣方須在合格證明書或地政總署署長的轉讓同意發出後的一個月內（以較早者為準），就賣方有能力有效地轉讓有關物業一事，以書面通知買家；或
- 如發展項目並非屬地政總署預售樓花同意方案所規管，賣方須在佔用文件（包括佔用許可證）發出後的六個月內，就賣方有能力有效地轉讓有關物業一事，以書面通知買家。
- 條例規定買賣合約須載有強制性條文，列明有關物業的買賣須於賣方發出上述通知的日期的 14 日內完成。有關物業的買賣完成後，賣方將安排買家收樓事宜。
- 認可人士可批予在預計關鍵日期之後完成發展項目
 - 條例規定買賣合約須載有強制性條文，列明發展項目的認可人士可以在顧及純粹由以下一個或多於一個原因所導致的延遲後，批予在預計關鍵日期之後，完成發展項目：
 - 工人罷工或封閉工地；
 - 暴動或內亂；
 - 不可抗力或天災；
 - 火警或其他賣方所不能控制的意外；
 - 戰爭；或
 - 惡劣天氣。
 - 發展項目的認可人士可以按情況，多於一次批予延後預計關鍵日期以完成發展項目，即收樓日期可能延遲。
 - 條例規定買賣合約須載有強制性條文，列明賣方須於認可人士批予延期後的 14 日內，向買家提供有關延期證明書的文本。
- 如對收樓日期有任何疑問，可向賣方查詢。

適用於一手已落成住宅物業

16. 賣方資料表格

- 確保取得最近三個月內印製有關您擬購買的一手已落成住宅物業的「賣方資料表格」。

17. 參觀物業

- 購置住宅物業前，確保已獲安排參觀您打算購置的住宅物業。倘參觀有關物業並非合理地切實可行，則應參觀與有關物業相若的物業，除非您以書面同意賣方無須開放與有關物業相若的物業供您參觀。您應仔細考慮，然後才決定是否簽署豁免上述規定的書面同意。
- 除非有關物業根據租約持有，或為確保物業參觀者的人身安全而須設定合理限制，您可以對該物業進行量度、拍照或拍攝影片。

任何與賣方銷售受條例所規管的一手住宅物業有關的投訴和查詢，請與一手住宅物業銷售監督局聯絡。

網址	: www.srpa.gov.hk
電話	: 2817 3313
電郵	: enquiry_srpa@hd.gov.hk
傳真	: 2219 2220

其他相關聯絡資料：

消費者委員會

網址	: www.consumer.org.hk
電話	: 2929 2222
電郵	: cc@consumer.org.hk
傳真	: 2856 3611

地產代理監督局

網址	: www.eaa.org.hk
電話	: 2111 2777
電郵	: enquiry@eaa.org.hk
傳真	: 2598 9596

香港地產建設商會

電話	: 2826 0111
傳真	: 2845 2521

- 1 按揭貸款計劃的資料包括有關按揭貸款計劃對借款人的最低收入的要求、就第一按揭連同第二按揭可獲得的按揭貸款金額上限、最長還款年期、整個還款期內的按揭利率變化，以及申請人須繳付的手續費。
- 2 根據條例附表1第1部第10(2)(d)條述明，售樓說明書內顯示的發展項目中的住宅物業的每一份樓面平面圖須述明以下各項—
 - (i) 每個住宅物業的外部尺寸；
 - (ii) 每個住宅物業的內部尺寸；
 - (iii) 每個住宅物業的內部間隔的厚度；
 - (iv) 每個住宅物業內個別分隔室的外部尺寸。
 根據條例附表1第1部第10(3)條，如有關發展項目的經批准的建築圖則，提供條例附表1第1部第10(2)(d)條所規定的資料，樓面平面圖須述明如此規定的該資料。
- 3 一般而言，「關鍵日期」指該項目符合批地文件的條件的日期，或該項目在遵照經批准的建築圖則的情況下或按照豁免證明書的發出的條件在各方面均屬完成的日期。有關詳情請參閱條例第2條。

You are advised to take the following steps before purchasing first-hand residential properties.

For all first-hand residential properties

1. Important information

- Make reference to the materials available on the Sales of First-hand Residential Properties Electronic Platform (SRPE) (www.srpe.gov.hk) on the first-hand residential property market.
- Study the information on the website designated by the vendor for the development, including the sales brochure, price lists, documents containing the sales arrangements, and the register of transactions of a development.
- Sales brochure for a development will be made available to the general public at least 7 days immediately before a date of sale while price list and sales arrangements will be made available at least 3 days immediately before the date of sale.
- Information on transactions can be found on the register of transactions on the website designated by the vendor for the development and the SRPE.

2. Fees, mortgage loan and property price

- Calculate the total expenses of the purchase, such as solicitors' fees, mortgage charges, insurance fees and stamp duties.
- Check with banks to find out if you will be able to obtain the needed mortgage loan, select the appropriate payment method and calculate the amount of the mortgage loan to ensure it is within your repayment ability.
- Check recent transaction prices of comparable properties for comparison.
- Check with the vendor or the estate agent the estimated management fee, the amount of management fee payable in advance (if any), special fund payable (if any), the amount of reimbursement of the deposits for water, electricity and gas (if any), and/or the amount of debris removal fee (if any) you have to pay to the vendor or the manager of the development.

3. Price list, payment terms and other financial incentives

- Vendors may not offer to sell all the residential properties that are covered in a price list. To know which residential properties the vendors may offer to sell, pay attention to the sales arrangements which will be announced by the vendors at least 3 days before the relevant residential properties are offered to be sold.
- Pay attention to the terms of payment as set out in a price list. If there are discounts on the price, gift, or any financial advantage or benefit to be made available in connection with the purchase of the residential properties, such information will also be set out in the price list.
- If you intend to opt for any mortgage loan plans offered by financial institutions specified by the vendor, before entering into a preliminary agreement for sale and purchase (PASP), you must study the details of various mortgage loan plans¹ as set out in the price list concerned. If you have any questions about these mortgage loan plans, you should check with the financial institutions concerned direct before entering into a PASP.

4. Property area and its surroundings

- Pay attention to the area information in the sales brochure and price list, and price per square foot/metre in the price list. According to the Residential Properties (First-hand Sales) Ordinance (Cap. 621) (the Ordinance), vendors can only present the area and price per square foot and per square metre of a residential property using saleable area. Saleable area, in relation to a residential property, means the floor area of the residential property, and includes the floor area of every one of the following to the extent that it forms part of the residential property - (i) a balcony; (ii) a utility platform; and (iii) a verandah. The saleable area excludes the area of the following which forms part of the residential property - air-conditioning plant room; bay window; cockloft; flat roof; garden; parking space; roof; stairhood; terrace and yard.
- Floor plans of all residential properties in the development have to be shown in the sales brochure. In a sales brochure, floor plans of residential properties in the development must state the external and internal dimensions of each residential property². The external and internal dimensions of residential properties as provided in the sales brochure exclude plaster and finishes. You are advised to note this if you want to buy furniture before handing over of the residential property.
- Visit the development site and get to know the surroundings of the property (including transportation and community facilities). Check town planning proposals and decisions which may affect the property. Take a look at the location plan, aerial photograph, outline zoning plan and cross-section plan that are provided in the sales brochure.

5. Sales brochure

- Ensure that the sales brochure you have obtained is the latest version. According to the Ordinance, the sales brochure made available to the public should be printed or examined, or examined and revised within the previous 3 months.
- Read through the sales brochure and in particular, check the following information in the sales brochure -
 - whether there is a section on “relevant information” in the sales brochure, under which information on any matter that is known to the vendor but is not known to the general public, and is likely to materially affect the enjoyment of a residential property will be set out. Please note that information contained in a document that has been registered with the Land Registry will not be regarded as “relevant information”;
 - the cross-section plan showing a cross-section of the building in relation to every street adjacent to the building, and the level of every such street in relation to a known datum and to the level of the lowest residential floor of the building. This will help you visualize the difference in height between the lowest residential floor of a building and the street level, regardless of how that lowest residential floor is named;
 - interior and exterior fittings and finishes and appliances;
 - the basis on which management fees are shared;
 - whether individual owners have obligations or need to share the expenses for managing, operating and maintaining the public open space or public facilities inside or outside the development, and the location of the public open space or public facilities; and
 - whether individual owners have responsibility to maintain slopes.

6. Government land grant and deed of mutual covenant (DMC)

- Read the Government land grant and the DMC (or the draft DMC). Information such as ownership of the rooftop and external walls can be found in the DMC. The vendor will provide copies of the Government land grant and the DMC (or the draft DMC) at the place where the sale is to take place for free inspection by prospective purchasers.
- Check the Government land grant on whether individual owners are liable to pay Government rent.
- Check the DMC on whether animals can be kept in the residential property.

7. Information on Availability of Residential Properties for Selection at Sales Office

- Check with the vendor which residential properties are available for selection. If a “consumption table” is displayed by the vendor at the sales office, you may check from the table information on the progress of sale on a date of sale, including which residential properties are offered for sale at the beginning of that date of sale and which of them have been selected and sold during that date of sale.
- Do not believe in rumours about the sales condition of the development and enter into a PASP rashly.

8. Register of Transactions

- Pay attention to the register of transactions for a development. A vendor must, within 24 hours after entering into a PASP with a purchaser, enter transaction information of the PASP in the register of transactions. The vendor must, within 1 working day after entering into an agreement for sale and purchase (ASP), enter transaction information of the ASP in the register of transactions. Check the register of transactions for the concerned development to learn more about the sales condition of the development.
- Never take the number of registrations of intent or cashier orders a vendor has received for the purpose of registration as an indicator of the sales volume of a development. The register of transactions for a development is the most reliable source of information from which members of the public can grasp the daily sales condition of the development.

9. Agreement for sale and purchase

- Ensure that the PASP and ASP include the mandatory provisions as required by the Ordinance.
- Pay attention that fittings, finishes and appliances to be included in the sale and purchase of the property are inserted in the PASP and ASP.
- Pay attention to the area plan annexed to the ASP which shows the total area which the vendor is selling to you. The total area which the vendor is selling to you is normally greater than the saleable area of the property.
- A preliminary deposit of **5%** of the purchase price is payable by you to the owner (i.e. the seller) on entering into a PASP.
- If you do not execute the ASP within **5 working days** (working day means a day that is not a general holiday or a Saturday or a black rainstorm warning day or gale warning day) after entering into the PASP, the PASP is terminated, the preliminary deposit (i.e. 5% of the purchase price) is forfeited, and the owner (i.e. the seller) does not have any further claim against you for not executing the ASP.
- If you execute the ASP within 5 working days after the signing of the PASP, the owner (i.e. the seller) must execute the ASP within 8 working days after entering into the PASP.

- The deposit should be made payable to the solicitors’ firm responsible for stakeholding purchasers’ payments for the property.

10. Expression of intent of purchasing a residential property

- Note that vendors (including their authorized representative(s)) should not seek or accept any specific or general expression of intent of purchasing any residential property before the relevant price lists for such properties are made available to the public. You therefore should not make such an offer to the vendors or their authorized representative(s).
- Note that vendors (including their authorized representative(s)) should not seek or accept any specific expression of intent of purchasing a particular residential property before the sale of the property has commenced. You therefore should not make such an offer to the vendors or their authorized representative(s).

11. Appointment of estate agent

- Note that if the vendor has appointed one or more than one estate agents to act in the sale of any specified residential property in the development, the price list for the development must set out the name of all the estate agents so appointed as at the date of printing of the price list.
- You may appoint any estate agent (not necessarily from those estate agency companies appointed by the vendor) to act in the purchase of any specified residential property in the development, and may also not appoint any estate agent to act on your behalf.
- Before you appoint an estate agent to look for a property, you should -
 - find out whether the agent will act on your behalf only. If the agent also acts for the vendor, he/she may not be able to protect your best interests in the event of a conflict of interest;
 - find out whether any commission is payable by you to the estate agent and, if so, its amount and the time of payment; and
 - note that only licensed estate agents or salespersons may accept your appointment. If in doubt, you should request the estate agent or salesperson to produce his/her Estate Agent Card, or check the Licence List on the Estate Agents Authority website: www.eaa.org.hk.

12. Appointment of solicitor

- Consider appointing your own solicitor to protect your interests. If the solicitor also acts for the vendor, he/she may not be able to protect your best interests in the event of a conflict of interest.
- Compare the charges of different solicitors.

For first-hand uncompleted residential properties

13. Pre-sale Consent

- For uncompleted residential property under the Lands Department Consent Scheme, seek confirmation from the vendor whether the “Pre-sale Consent” has been issued by the Lands Department for the development.

14. Show flats

- While the vendor is not required to make any show flat available for viewing by prospective purchasers or the general public, if the vendor wishes to make available show flats of a specified residential property, the vendor must first of all make available an unmodified show flat of that residential property and that, having made available such unmodified show flat, the vendor may then make available a modified show flat of that residential property. In this connection, the vendor is allowed to make available more than one modified show flat of that residential property.
- If you visit the show flats, you should always look at the unmodified show flats for comparison with the modified show flats. That said, the Ordinance does not restrict the discretion of the vendor in arranging the sequence of the viewing of unmodified and modified show flats.
- Sales brochure of the development should have been made available to the public when the show flat is made available for viewing. You are advised to get a copy of the sales brochure and make reference to it when viewing the show flats.
- You may take measurements in modified and unmodified show flats, and take photographs or make video recordings of unmodified show flats, subject to reasonable restriction(s) which may be set by the vendor for ensuring safety of the persons viewing the show flat.

For first-hand uncompleted residential properties and completed residential properties pending compliance

15. Estimated material date and handing over date

- Check the estimated material date³ for the development in the sales brochure.
 - The estimated material date for a development in the sales brochure is not the same as the date on which a residential property is handed over to purchaser. The latter is inevitably later than the former.
- Handing over date
 - The mandatory provisions to be incorporated in an ASP as required by the Ordinance include a provision requiring the vendor to apply in writing for an Occupation Document / a Certificate of Compliance or the Director of Lands' Consent to Assign (as the case may be) in respect of the development within 14 days after the estimated material date as stipulated in the ASP.
 - For development subject to the Lands Department Consent Scheme, the vendor is required to notify the purchaser in writing that the vendor is in a position validly to assign the property within one month after the issue of the Certificate of Compliance or the Consent to Assign, whichever first happens; or
 - For development not subject to the Lands Department Consent Scheme, the vendor is required to notify the purchaser in writing that the vendor is in a position validly to assign the property within 6 months after the issue of the Occupation Document including Occupation Permit.
 - The mandatory provisions to be incorporated in an ASP as required by the Ordinance include a provision requiring completion of the sale and purchase within 14 days after the date of the notification aforesaid. Upon completion, the vendor shall arrange handover of the property to the purchaser.
- Authorized Person (AP) may grant extension(s) of time for completion of the development beyond the estimated material date.

- The mandatory provisions to be incorporated in an ASP as required by the Ordinance include a provision that the AP of a development may grant an extension of time for completion of the development beyond the estimated material date having regard to delays caused exclusively by any one or more of the following reasons:
 - strike or lock-out of workmen;
 - riots or civil commotion;
 - force majeure or Act of God;
 - fire or other accident beyond the vendor's control;
 - war; or
 - inclement weather.
 - The AP may grant more than once such an extension of time depending on the circumstances. That means handover of the property may be delayed.
 - The mandatory provisions to be incorporated in an ASP as required by the Ordinance also include a provision requiring the vendor to, within 14 days after the issue of an extension of time granted by the AP, furnish the purchaser with a copy of the relevant certificate of extension.
- Ask the vendor if there are any questions on handing over date.

For first-hand completed residential properties

16. Vendor's information form

- Ensure that you obtain the "vendor's information form(s)" printed within the previous 3 months in relation to the residential property/properties you intend to purchase.

17. Viewing of property

- Ensure that, before you purchase a residential property, you are arranged to view the residential property that you would like to purchase or, if it is not reasonably practicable to view the property in question, a comparable property in the development, unless you agree in writing that the vendor is not required to arrange such a comparable property for viewing for you. You are advised to think carefully before signing any waiver.
- You may take measurements, take photographs or make video recordings of the property, unless the property is held under a tenancy or reasonable restriction(s) is/are needed to ensure safety of the persons viewing the property.

For complaints and enquiries relating to the sales of first-hand residential properties by the vendors which the Ordinance applies, please contact the Sales of First-hand Residential Properties Authority -

Website	: www.srpa.gov.hk
Telephone	: 2817 3313
Email	: enquiry_srpa@hd.gov.hk
Fax	: 2219 2220

Other useful contacts:

Consumer Council	
Website	: www.consumer.org.hk
Telephone	: 2929 2222
Email	: cc@consumer.org.hk
Fax	: 2856 3611

Estate Agents Authority	
Website	: www.eaa.org.hk
Telephone	: 2111 2777
Email	: enquiry@eaa.org.hk
Fax	: 2598 9596

Real Estate Developers Association of Hong Kong	
Telephone	: 2826 0111
Fax	: 2845 2521

-
- 1 The details of various mortgage loan plans include the requirements for mortgagors on minimum income level, the loan limit under the first mortgage and second mortgage, the maximum loan repayment period, the change of mortgage interest rate throughout the entire repayment period, and the payment of administrative fees.
 - 2 According to section 10(2)(d) in Part 1 of Schedule 1 to the Ordinance, each of the floor plans of the residential properties in the development in the sales brochure must state the following—
 - (i) the external dimensions of each residential property;
 - (ii) the internal dimensions of each residential property;
 - (iii) the thickness of the internal partitions of each residential property;
 - (iv) the external dimensions of individual compartments in each residential property.According to section 10(3) in Part 1 of Schedule 1 to the Ordinance, if any information required by section 10(2)(d) in Part 1 of Schedule 1 to the Ordinance is provided in the approved building plans for the development, a floor plan must state the information as so provided.
 - 3 Generally speaking, “material date” means the date on which the conditions of the land grant are complied with in respect of the development, or the date on which the development is completed in all respects in compliance with the approved building plans or the conditions subject to which the certificate of exemption is issued. For details, please refer to section 2 of the Ordinance.

1 發展項目高爾夫·御苑的資料

INFORMATION ON THE DEVELOPMENT, EDEN MANOR

街道名稱及門牌號數

青山公路古洞段 88 號

發展項目包含多單位建築物及洋房

多單位建築物

樓層總數

住宅共 8 座 (不設第 4 座)

第 1、2、3、5、6、7、8 及 9，每幢均有 25 層

上述樓層數目並不包括兩層地庫及天台

樓層號數

各座均有地庫 2 樓、地庫 1 樓、地下、1 樓至 3 樓、5 樓至 12 樓、15 樓至 23 樓、25 樓至 28 樓 (第 1 及 2 座住宅由 2 樓開始；第 3 至第 9 座住宅由 1 樓開始)

被略去的樓層號數

每座不設 4 樓、13 樓、14 樓及 24 樓

庇護層

不適用

洋房(獨立屋)

洋房的總數

25

洋房的門牌號數

A1 至 A3 洋房、A5 至 A12 洋房、B1 至 B3 洋房、B5 至 B8 洋房、C1 至 C3 洋房及 C5 至 C8 洋房

洋房被略去的門牌號數

A4 洋房、B4 洋房及 C4 洋房

本發展項目屬未落成發展項目

- 由該項目的認可人士提供的該項目的預計關鍵日期為 2019 年 4 月 30 日 (註：認可人士已按買賣合約就該日期批出合共 98 天之延期至 2019 年 8 月 6 日)。
- 預計關鍵日期，是受到買賣合約所允許的任何延期所規限的。
- 根據批地文件，進行該項買賣，需獲地政總署署長同意。為買賣合約的目的，在不局限任何其他可用以證明發展項目落成的方法的原則下，地政總署署長發出的合格證明書或轉讓同意，即為該發展項目已落成或當作已落成 (視屬何情況而定) 的確證。

Name of the street and the street number

No. 88 Castle Peak Road Kwu Tung

The Development consists of multi-unit buildings and houses

Multi-unit buildings

Total number of storeys

There are totally 8 towers (Tower 4 is omitted)

Each of Tower 1, 2, 3, 5, 6, 7, 8 and 9 contains 25 storeys. Numbers of storeys above do not include two basement floors and roof floor

Floor numbering

Each Tower contains B2/F, B1/F, G/F, 1/F to 3/F, 5/F to 12/F, 15/F to 23/F, 25/F to 28/F. (For Tower 1 and Tower 2, residential floor starts from 2/F; for Tower 3 to Tower 9, residential floor starts from 1/F)

Omitted floor numbers

4/F, 13/F, 14/F and 24/F are omitted in each tower

Refuge floor

Not applicable

Houses

Total number of houses

25

House numbering

House A1 to House A3, House A5 to House A12, House B1 to House B3, House B5 to House B8, House C1 to House C3 and House C5 to House C8

Omitted house numbers

House A4, House B4 and House C4

This development is an uncompleted development

- The estimated material date for the development, as provided by the Authorized Person for the development is 30th April 2019 (Note: a total extension of 98 days beyond that date has been granted by the Authorized Person under the Agreements for Sale and Purchase to 6th August 2019).
- The estimated material date is subject to any extension of time that is permitted under the Agreement for Sale and Purchase.
- Under the land grant, the consent of the Director of Lands is required to be given for the sale and purchase. For the purpose of the Agreement for Sale and Purchase, without limiting any other means by which the completion of the development may be proved, the issue of a certificate of compliance or consent to assign by the Director of Lands is conclusive evidence that the development has been completed or is deemed to be completed (as the case may be).

2 賣方及有參與發展項目的其他人的資料 INFORMATION ON VENDOR AND OTHERS INVOLVED IN THE DEVELOPMENT

賣方

榮彩發展有限公司 (亦為擁有人及其控權公司為恒基兆業有限公司及恒基兆業地產有限公司)

發展項目的認可人士

呂元祥建築師事務所(香港)有限公司的呂元祥博士
(呂元祥博士為呂元祥建築師事務所(香港)有限公司的董事)

承建商

恒麗建築有限公司

賣方代表律師

胡關李羅律師行

已為發展項目的建造提供貸款或已承諾為該項建造提供融資的認可機構

香港上海滙豐銀行有限公司

已為發展項目的建造提供貸款的任何其他人

恒基兆業地產代理有限公司

Vendor

Winjoy Development Limited (also as the owner and whose holding companies are Henderson Development Limited and Henderson Land Development Company Limited)

Authorized person for the development

Dr. Lu Yuen Cheung Ronald of Ronald Lu & Partners (Hong Kong) Limited
(Dr. Lu Yuen Cheung Ronald is a director of Ronald Lu & Partners (Hong Kong) Limited)

Building contractor for the development

Heng Lai Construction Company Limited

Vendor's solicitors

Woo Kwan Lee & Lo

Authorized institution that has made a loan, or has undertaken to provide finance, for the construction of the development

The Hongkong and Shanghai Banking Corporation Limited

Any other person who has made a loan for the construction of the development

Henderson Real Estate Agency Limited

3 有參與發展項目的各方的關係

RELATIONSHIP BETWEEN PARTIES INVOLVED IN THE DEVELOPMENT

(a) 賣方或有關發展項目的承建商屬個人，並屬該項目的認可人士的家人；	不適用
(b) 賣方或該項目的承建商屬合夥，而該賣方或承建商的合夥人屬上述認可人士的家人；	不適用
(c) 賣方或該項目的承建商屬法團，而該賣方或承建商 (或該賣方的控權公司) 的董事或秘書屬上述認可人士的家人；	否
(d) 賣方或該項目的承建商屬個人，並屬上述認可人士的有聯繫人士的家人；	不適用
(e) 賣方或該項目的承建商屬合夥，而該賣方或承建商的合夥人屬上述認可人士的有聯繫人士的家人；	不適用
(f) 賣方或該項目的承建商屬法團，而該賣方或承建商 (或該賣方的控權公司) 的董事或秘書屬上述認可人士的有聯繫人士的家人；	否
(g) 賣方或該項目的承建商屬個人，並屬就該項目內的住宅物業的出售代表擁有人行事的律師事務所行事的經營人的家人；	不適用
(h) 賣方或該項目的承建商屬合夥，而該賣方或承建商的合夥人屬就該項目內的住宅物業的出售代表擁有人行事的律師事務所行事的經營人的家人；	不適用
(i) 賣方或該項目的承建商屬法團，而該賣方或承建商 (或該賣方的控權公司) 的董事或秘書屬上述律師事務所的經營人的家人；	否
(j) 賣方、賣方的控權公司或有關發展項目的承建商屬私人公司，而該項目的認可人士或該認可人士的有聯繫人士持有該賣方、控權公司或承建商最少 10% 的已發行股份；	否
(k) 賣方、賣方的控權公司或該項目的承建商屬上市公司，而上述認可人士或上述有聯繫人士持有該賣方、控權公司或承建商最少 1% 的已發行股份；	否
(l) 賣方或該項目的承建商屬法團，而上述認可人士或上述有聯繫人士屬該賣方、承建商或該賣方的控權公司的僱員、董事或秘書；	否
(m) 賣方或該項目的承建商屬合夥，而上述認可人士或上述有聯繫人士屬該賣方或承建商的僱員；	不適用
(n) 賣方、賣方的控權公司或該項目的承建商屬私人公司，而就該項目中的住宅物業的出售而代表擁有人行事的律師事務所的經營人持有該賣方、控權公司或承建商最少 10% 的已發行股份；	否

(o) 賣方、賣方的控權公司或該項目的承建商屬上市公司，而上述律師事務所的經營人持有該賣方、控權公司或承建商最少 1% 的已發行股份；	否
(p) 賣方或該項目的承建商屬法團，而上述律師事務所的經營人屬該賣方或承建商或該賣方的控權公司的僱員、董事或秘書；	是 ¹
(q) 賣方或該項目的承建商屬合夥，而上述律師事務所的經營人屬該賣方或承建商的僱員；	不適用
(r) 賣方或該項目的承建商屬法團，而該項目的認可人士以其專業身分擔任董事或僱員的法團為該賣方或承建商或該賣方的控權公司的有聯繫法團；	否
(s) 賣方或該項目的承建商屬法團，而該承建商屬該賣方或該賣方的控權公司的有聯繫法團。	是 ²

1. 賣方代表律師胡關李羅律師行合伙人之一為恒基兆業地產有限公司非執行董事。

2. 承建商恒麗建築有限公司屬於賣方及其所有控權公司的有聯繫法團。

3 有參與發展項目的各方的關係

RELATIONSHIP BETWEEN PARTIES INVOLVED IN THE DEVELOPMENT

(a) The vendor or a building contractor for the development is an individual, and that vendor or contractor is an immediate family member of an authorized person for the development;	Not Applicable
(b) The vendor or a building contractor for the development is a partnership, and a partner of that vendor or contractor is an immediate family member of such an authorized person;	Not Applicable
(c) The vendor or a building contractor for the development is a corporation, and a director or the secretary of that vendor or contractor (or a holding company of that vendor) is an immediate family member of such an authorized person;	No
(d) The vendor or a building contractor for the development is an individual, and that vendor or contractor is an immediate family member of an associate of such an authorized person;	Not Applicable
(e) The vendor or a building contractor for the development is a partnership, and a partner of that vendor or contractor is an immediate family member of an associate of such an authorized person;	Not Applicable
(f) The vendor or a building contractor for the development is a corporation, and a director or the secretary of that vendor or contractor (or a holding company of that vendor) is an immediate family member of an associate of such an authorized person;	No
(g) The vendor or a building contractor for the development is an individual, and that vendor or contractor is an immediate family member of a proprietor of a firm of solicitors acting for the owner in relation to the sale of residential properties in the development;	Not Applicable
(h) The vendor or a building contractor for the development is a partnership, and a partner of that vendor or contractor is an immediate family member of a proprietor of a firm of solicitors acting for the owner in relation to the sale of residential properties in the development;	Not Applicable
(i) The vendor or a building contractor for the development is a corporation, and a director or the secretary of that vendor or contractor (or a holding company of that vendor) is an immediate family member of a proprietor of such a firm of solicitors;	No
(j) The vendor, a holding company of the vendor, or a building contractor for the development, is a private company, and an authorized person for the development, or an associate of such an authorized person, holds at least 10% of the issued shares in that vendor, holding company or contractor;	No
(k) The vendor, a holding company of the vendor, or a building contractor for the development, is a listed company, and such an authorized person, or such an associate, holds at least 1% of the issued shares in that vendor, holding company or contractor;	No
(l) The vendor or a building contractor for the development is a corporation, and such an authorized person, or such an associate, is an employee, director or secretary of that vendor or contractor or of a holding company of that vendor;	No
(m) The vendor or a building contractor for the development is a partnership, and such an authorized person, or such an associate, is an employee of that vendor or contractor;	Not Applicable

(n) The vendor, a holding company of the vendor, or a building contractor for the development, is a private company, and a proprietor of a firm of solicitors acting for the owner in relation to the sale of residential properties in the development holds at least 10% of the issued shares in that vendor, holding company or contractor;	No
(o) The vendor, a holding company of the vendor, or a building contractor for the development, is a listed company, and a proprietor of such a firm of solicitors holds at least 1% of the issued shares in that vendor, holding company or contractor;	No
(p) The vendor or a building contractor for the development is a corporation, and a proprietor of such a firm of solicitors is an employee, director or secretary of that vendor or contractor or of a holding company of that vendor;	Yes ¹
(q) The vendor or a building contractor for the development is a partnership, and a proprietor of such a firm of solicitors is an employee of that vendor or contractor;	Not Applicable
(r) The vendor or a building contractor for the development is a corporation, and the corporation of which an authorized person for the development is a director or employee in his or her professional capacity is an associate corporation of that vendor or contractor or of a holding company of that vendor;	No
(s) The vendor or a building contractor for the development is a corporation, and that contractor is an associate corporation of that vendor or of a holding company of that vendor.	Yes ²

1. A partner of vendor's solicitor, Woo Kwan Lee & Lo, is a non-executive director of Henderson Land Development Company Limited.
2. The building contractor, Heng Lai Construction Company Limited, is an associate corporation of the vendor and all its holding companies.

4 發展項目的設計的資料

INFORMATION ON DESIGN OF THE DEVELOPMENT

發展項目將會有構成圍封牆的一部分的非結構的預製外牆。

There will be non-structural prefabricated external walls forming part of the enclosing walls of the development.

每幢建築物的非結構的預製外牆的厚度範圍為 150 毫米。

The range of thickness of the non-structural prefabricated external walls of each block is 150mm.

發展項目將會有構成圍封牆的一部分的幕牆。

There will be curtain walls forming part of the enclosing walls of the development.

每幢建築物的幕牆的厚度為 300 毫米。

The range of thickness of the curtain walls of each building is 300mm.

每個住宅物業的非結構的預製外牆及幕牆的總面積表

Schedule of total area of the non-structural prefabricated external walls and curtain walls of each residential property

洋房 House	每個住宅物業的非結構的預製外牆的總面積 (平方米) The total area of the non-structural prefabricated external walls of each residential property (sq.m.)	每個住宅物業的幕牆的總面積 (平方米) The total area of the curtain walls of each residential property (sq.m.)
A1, A2, A3, A5, A9, A10,	5.347	4.194
B2, B3, B5, B6, B7, B8	5.347	4.194
C1, C2, C6, C7	5.347	4.194
C3, C5	2.189	4.194
C8	5.347	2.744
A6, A7, A8	6.691	3.641
B1	6.691	3.641
A11, A12	4.560	3.687

座數 Tower	樓層 Floor	室 Flat	每個住宅物業的非結構的預製外牆的總面積 (平方米) The total area of the non-structural prefabricated external walls of each residential property (sq.m.)	每個住宅物業的幕牆的總面積 (平方米) The total area of the curtain walls of each residential property (sq.m.)
第1座 Tower 1	2樓 2/F	A	0.773	5.811
		B	0.595	4.788
	3樓、5樓至12樓、 15樓至23樓及 25樓至27樓 3/F, 5/F - 12/F, 15/F - 23/F and 25/F - 27/F	A	0.773	6.174
		B	0.783	5.120
28樓 28/F	A	1.266	7.278	
第2座 Tower 2	2樓 2/F	A	0.773	5.811
		B	0.595	4.788
	3樓、5樓至12樓、 15樓至23樓及 25樓至27樓 3/F, 5/F - 12/F, 15/F - 23/F and 25/F - 27/F	A	0.773	6.174
		B	0.783	5.120
28樓 28/F	A	1.266	7.278	
第3座 Tower 3	1樓 1/F	A	0.920	4.171
		B	0.715	4.152
	2樓至3樓、 5樓至12樓、 15樓至23樓及 25樓至27樓 2/F - 3/F, 5/F - 12/F, 15/F - 23/F and 25/F - 27/F	A	0.920	4.503
		B	0.903	4.484
28樓 28/F	A	2.046	5.957	
第5座 Tower 5	1樓 1/F	A	0.715	4.152
		B	0.715	4.152
	2樓至3樓、 5樓至12樓、 15樓至23樓及 25樓至27樓 2/F - 3/F, 5/F - 12/F, 15/F - 23/F and 25/F - 27/F	A	0.903	4.484
		B	0.903	4.484
28樓 28/F	A	2.030	5.957	

4 發展項目的設計的資料

INFORMATION ON DESIGN OF THE DEVELOPMENT

座數 Tower	樓層 Floor	室 Flat	每個住宅物業的非結構的 預製外牆的總面積 (平方米) The total area of the non-structural prefabricated external walls of each residential property (sq.m.)	每個住宅物業的幕牆的 總面積 (平方米) The total area of the curtain walls of each residential property (sq.m.)
第6座 Tower 6	1樓 1/F	A	1.186	3.668
		B	0.715	4.152
	2樓至3樓、 5樓至12樓、 15樓至23樓及 25樓至27樓 2/F - 3/F, 5/F - 12/F, 15/F - 23/F and 25/F - 27/F	A	1.186	3.668
		B	0.903	4.484
28樓 28/F	A	1.716	6.845	
第7座 Tower 7	1樓至3樓、 5樓至12樓、 15樓至23樓及 25樓至28樓 1/F - 3/F, 5/F - 12/F, 15/F - 23/F and 25/F - 28/F	A	-	2.267
		B	-	0.610
		C	-	0.610
		D	-	0.610
		E	-	0.610
		F	-	2.267
		G	-	0.728
		H	1.020	0.653
		J	1.095	0.653
		K	-	0.728
第8座 Tower 8	1樓 1/F	A	1.186	2.922
		B	0.715	4.152
	2樓 2/F	A	1.186	2.922
		B	0.903	4.484
	3樓、5樓至12樓、 15樓至23樓及 25樓至27樓 3/F, 5/F - 12/F, 15/F - 23/F and 25/F - 27/F	A	1.186	3.668
		B	0.903	4.484
28樓 28/F	A	1.716	6.845	

座數 Tower	樓層 Floor	室 Flat	每個住宅物業的非結構的 預製外牆的總面積 (平方米) The total area of the non-structural prefabricated external walls of each residential property (sq.m.)	每個住宅物業的幕牆的 總面積 (平方米) The total area of the curtain walls of each residential property (sq.m.)
第9座 Tower 9	1樓 1/F	A	0.920	4.171
		B	0.715	4.152
	2樓至3樓、 5樓至12樓、 15樓至23樓及 25樓至27樓 2/F - 3/F, 5/F - 12/F, 15/F - 23/F and 25/F - 27/F	A	0.920	4.503
		B	0.903	4.484
28樓 28/F	A	2.046	5.957	

管理人

根據發展項目的公契的最新擬稿，偉邦物業管理有限公司將獲委任為發展項目的管理人。

Manager

Well Born Real Estate Management Limited will be appointed as the Manager of the development under the latest draft deed of mutual covenant in respect of the development.



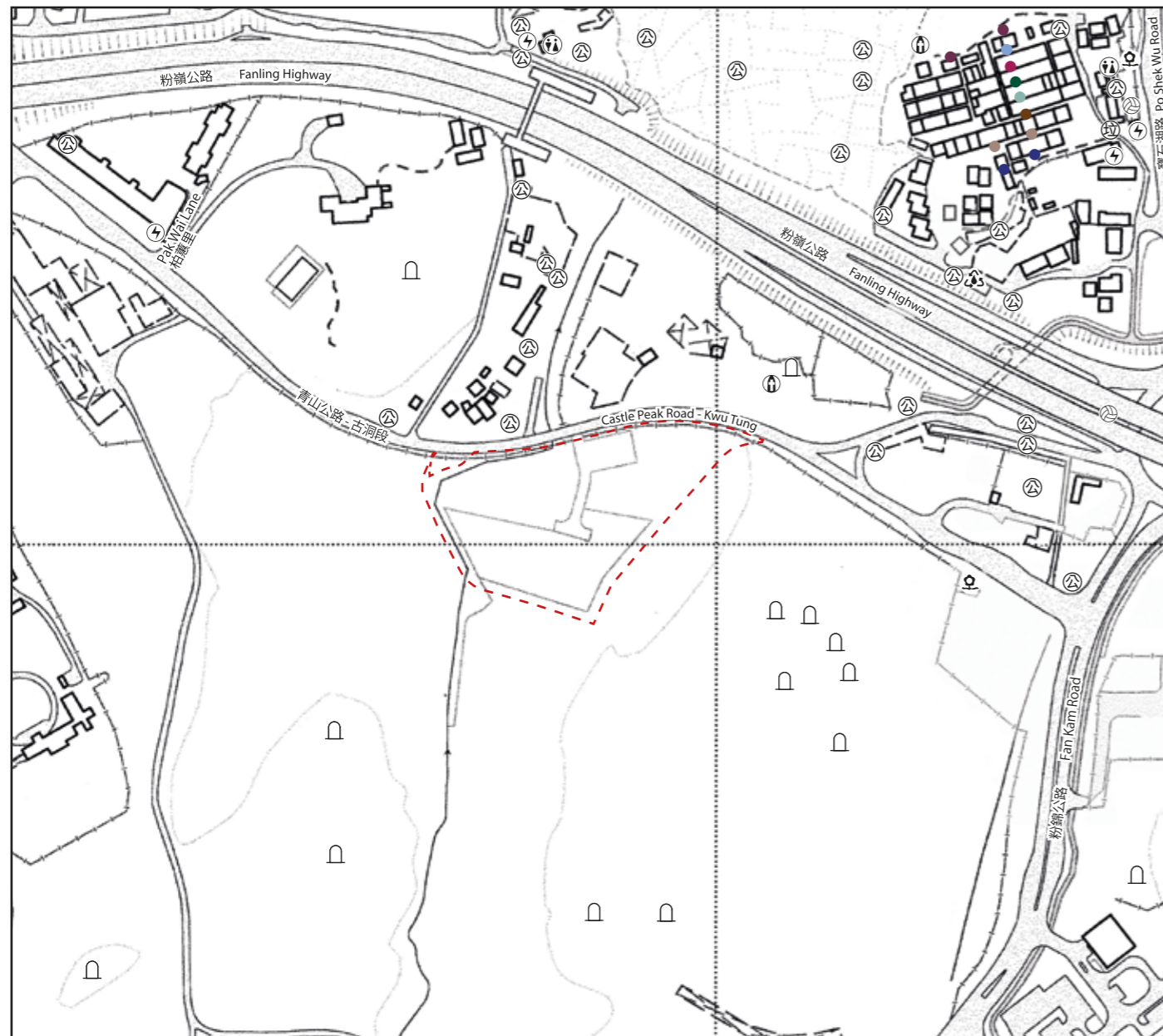





6 發展項目的所在位置圖 LOCATION PLAN OF THE DEVELOPMENT



 發展項目的位置
Location of the Development

比例：0米/M 250米/M
Scale: 

圖例 NOTATION

-  污水處理廠及設施 Sewage treatment works and facilities
-  墳場 Cemetery
-  垃圾收集站 Refuse collection point
-  公用事業設施裝置 Public utility installation
-  宗教場所（包括教堂、廟宇及祠堂） Religious institution (including church, temple and Tsz Tong)
-  公廁 Public convenience
-  發電廠（包括電力分站） Power plant (including electricity sub-stations)
-  公園 Public park
-  體育設施（包括運動場及游泳池） Sports facilities (including a sports ground and a swimming pool)

於所在位置圖未能顯示全名之街道
Street name not shown in full in the location plan

-  大頭嶺第一巷 Tai Tau Leng 1st Lane
-  大頭嶺第二巷 Tai Tau Leng 2nd Lane
-  大頭嶺第三巷 Tai Tau Leng 3rd Lane
-  大頭嶺第四巷 Tai Tau Leng 4th Lane
-  大頭嶺第五巷 Tai Tau Leng 5th Lane
-  大頭嶺第六巷 Tai Tau Leng 6th Lane
-  大頭嶺第七巷 Tai Tau Leng 7th Lane
-  大頭嶺第八巷 Tai Tau Leng 8th Lane

地圖版權屬香港特區政府，經地政總署准許複印，版權特許編號 102/2016。

The map is reproduced with permission of the Director of Lands. © The Government of the Hong Kong SAR. Licence No. 102/2016.

上述位置圖參考測繪圖編號 3-SW-A，經修正處理。

The above location plan is made with reference to Survey Sheet No. 3-SW-A with adjustments where necessary.

備註：因技術性問題，此位置圖所顯示的範圍超過《一手住宅物業銷售條例》的規定。

Note : Due to technical reasons, this location plan has shown more than the area required under the Residential Properties (First-hand Sales) Ordinance.



香港特別行政區政府地政總署測繪處版權所有，未經許可，不得複製。
Survey and Mapping Office, Lands Department, The Government of HKSAR© Copyright reserved – reproduction by permission only.

摘錄自地政總署測繪處於2017年4月3日在6,900呎飛行高度拍攝之鳥瞰照片，編號為E018640C。
Adopted from part of the aerial photograph taken by the Survey and Mapping Office of the Lands Department at a flying height of 6,900 feet, Photo No.E018640C dated 3rd April 2017.

備註：因技術性問題，此鳥瞰照片所顯示的範圍超過《一手住宅物業銷售條例》的規定。
Note: Due to technical reasons, this aerial photograph has shown more than the area required under the Residential Properties (First-hand Sales) Ordinance.



鳥瞰照片並不覆蓋本空白範圍
This blank area falls outside the coverage of the relevant aerial photograph

香港特別行政區政府地政總署測繪處版權所有，未經許可，不得複製。
Survey and Mapping Office, Lands Department, The Government of HKSAR© Copyright reserved - reproduction by permission only.

摘錄自地政總署測繪處於2018年3月27日在6,900呎飛行高度拍攝之鳥瞰照片，編號為E040028C。
Adopted from part of the aerial photograph taken by the Survey and Mapping Office of the Lands Department at a flying height of 6,900 feet, Photo No.E040028C dated 27th March 2018.

備註：因技術性問題，此鳥瞰照片所顯示的範圍超過《一手住宅物業銷售條例》的規定。
Note：Due to technical reasons, this aerial photograph has shown more than the area required under the Residential Properties (First-hand Sales) Ordinance.



鳥瞰照片並不覆蓋本空白範圍
This blank area falls outside the coverage of the relevant aerial photograph

香港特別行政區政府地政總署測繪處版權所有，未經許可，不得複製。
Survey and Mapping Office, Lands Department, The Government of HKSAR© Copyright reserved - reproduction by permission only.

摘錄自地政總署測繪處於2018年3月27日在6,900呎飛行高度拍攝之鳥瞰照片，編號為E040029C。
Adopted from part of the aerial photograph taken by the Survey and Mapping Office of the Lands Department at a flying height of 6,900 feet, Photo No.E040029C dated 27th March 2018.

備註： 因技術性問題，此鳥瞰照片所顯示的範圍超過《一手住宅物業銷售條例》的規定。
Note : Due to technical reasons, this aerial photograph has shown more than the area required under the Residential Properties (First-hand Sales) Ordinance.

鳥瞰照片並不覆蓋本空白範圍
This blank area falls outside the coverage of the relevant aerial photograph

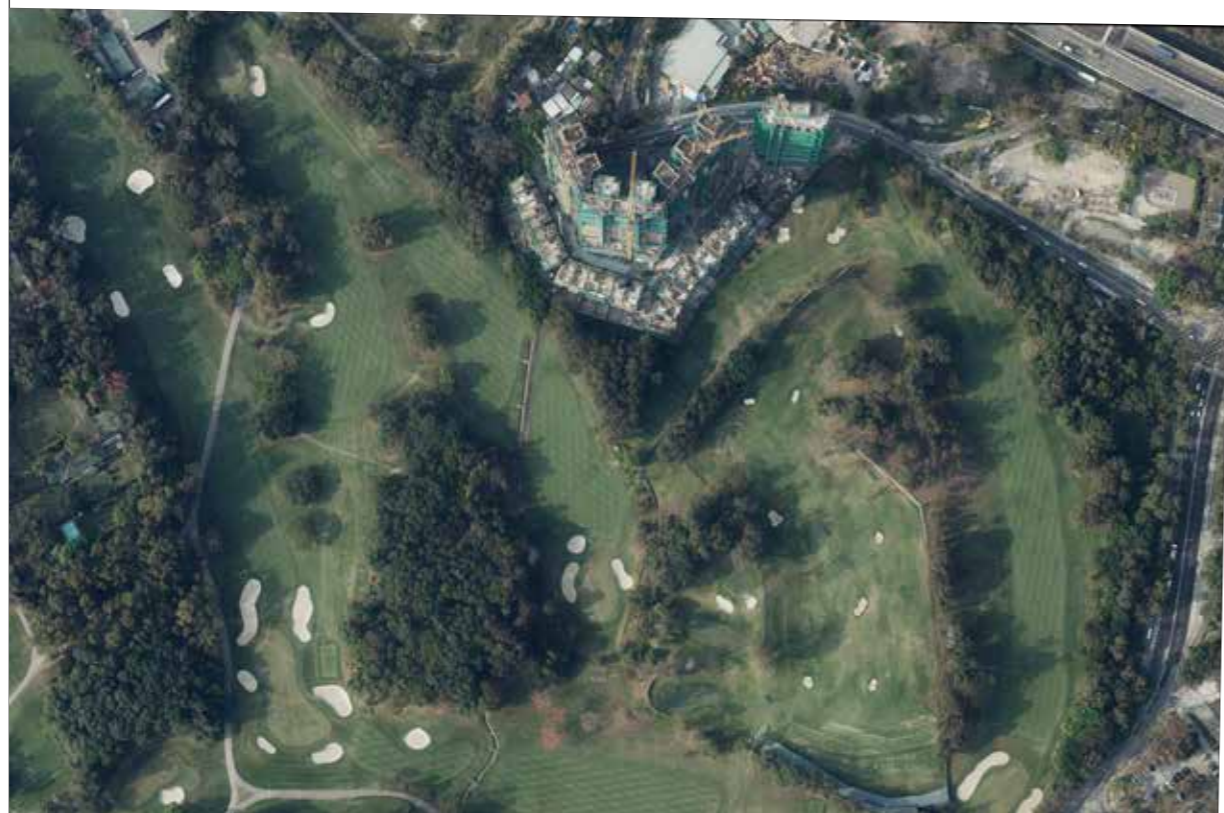

香港特別行政區政府地政總署測繪處版權所有，未經許可，不得複製。
Survey and Mapping Office, Lands Department, The Government of HKSAR© Copyright reserved – reproduction by permission only.

摘錄自地政總署測繪處於2018年3月12日在6,900呎飛行高度拍攝之鳥瞰照片，編號為E034485C。
Adopted from part of the aerial photograph taken by the Survey and Mapping Office of the Lands Department at a flying height of 6,900 feet, Photo No.E034485C dated 12th March 2018.

備註：因技術性問題，此鳥瞰照片所顯示的範圍超過《一手住宅物業銷售條例》的規定。
Note : Due to technical reasons, this aerial photograph has shown more than the area required under the Residential Properties (First-hand Sales) Ordinance.

鳥瞰照片並不覆蓋本空白範圍
This blank area falls outside the coverage of the relevant aerial photograph

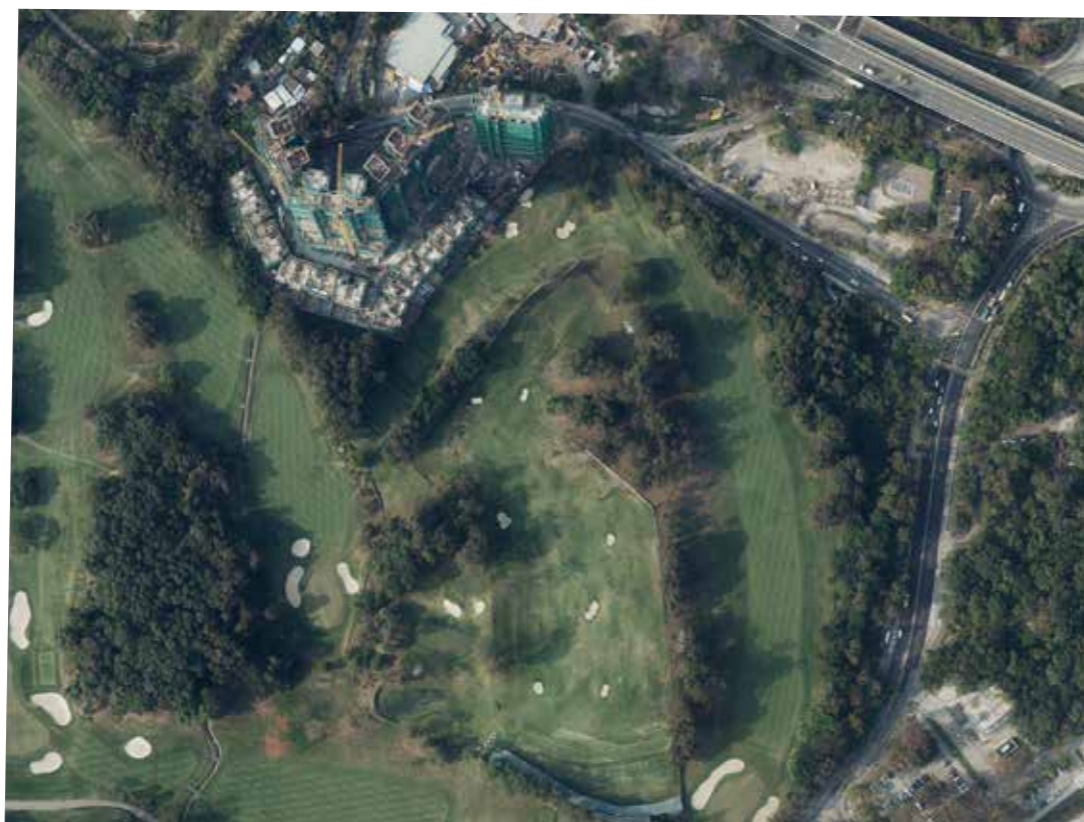

香港特別行政區政府地政總署測繪處版權所有，未經許可，不得複製。

Survey and Mapping Office, Lands Department, The Government of HKSAR© Copyright reserved - reproduction by permission only.

摘錄自地政總署測繪處於2018年3月12日在6,900呎飛行高度拍攝之鳥瞰照片，編號為E034484C。

Adopted from part of the aerial photograph taken by the Survey and Mapping Office of the Lands Department at a flying height of 6,900 feet, Photo No.E034484C dated 12th March 2018.

備註：因技術性問題，此鳥瞰照片所顯示的範圍超過《一手住宅物業銷售條例》的規定。

Note : Due to technical reasons, this aerial photograph has shown more than the area required under the Residential Properties (First-hand Sales) Ordinance.

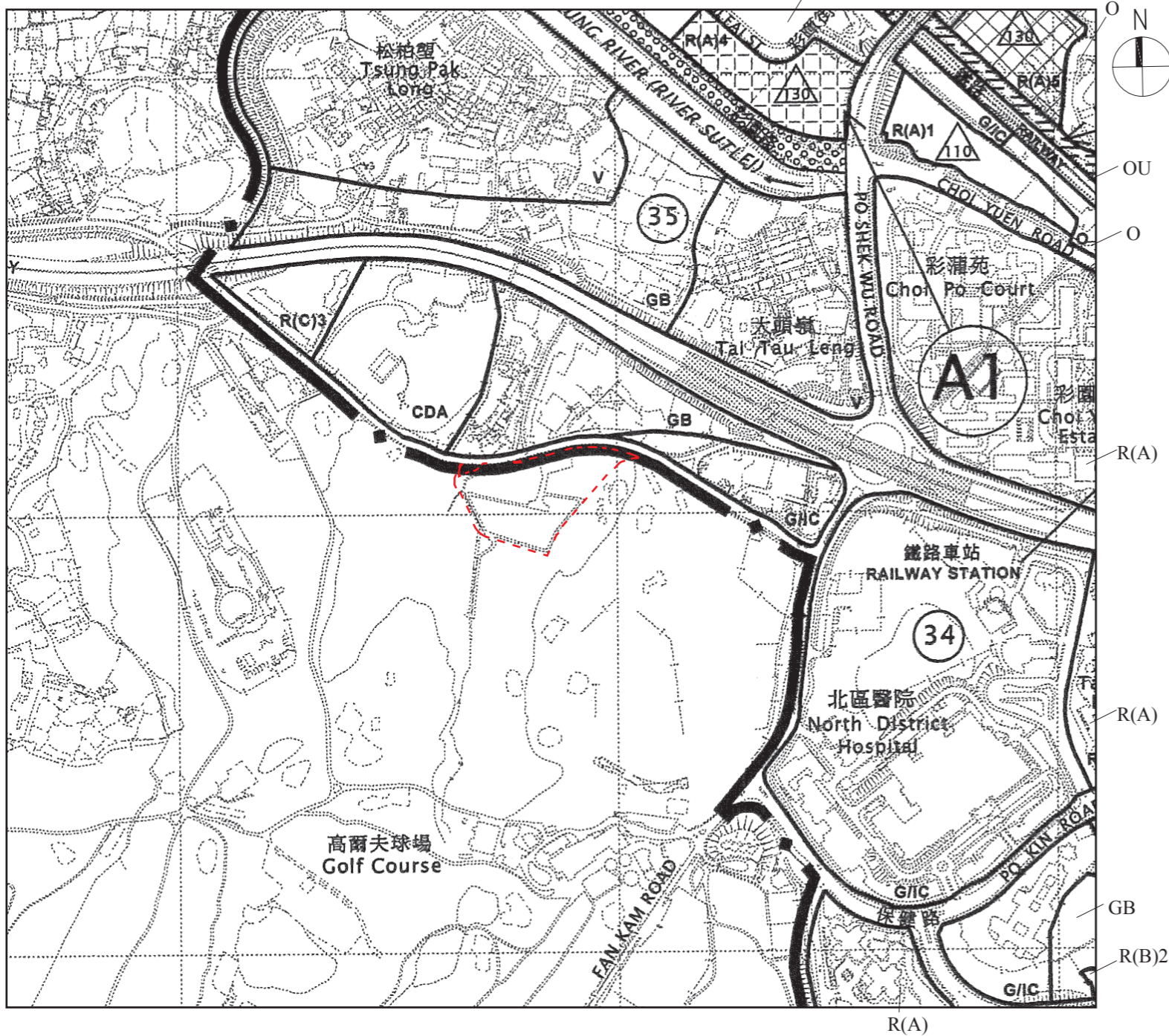



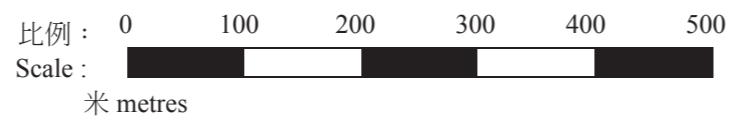







 發展項目的位置
 Location of the Development



摘錄自2019年3月29日刊憲之粉嶺/上水分區計劃大綱草圖，圖則編號為 S/FSS/23。
 Excerpt from the draft Fanling/Sheung Shui Outline Zoning Plan with Plan No. S/FSS/23, gazetted on 29th March 2019.

圖例 NOTATION



地帶 ZONES

 CDA	綜合發展區 Comprehensive Development Area	 I	工業 Industrial
 R(A)	住宅（甲類） Residential (Group A)	 G/IC	政府、機構或社區 Government, Institution or Community
 R(B)	住宅（乙類） Residential (Group B)	 O	休憩用地 Open Space
 R(C)	住宅（丙類） Residential (Group C)	 OU	其他指定用途 Other Specified Uses
 V	鄉村式發展 Village Type Development	 GB	綠化地帶 Green Belt

交通 COMMUNICATIONS

	主要道路及路口 Major road and junction
	高架道路 Elevated road

其他 MISCELLANEOUS

	規劃範圍界線 Boundary of planning scheme
	規劃區域編號 Planning area number
	最高建築物高度（在主水平基準上若米） Maximum building height (in metres above principal datum)

按照《城市規劃條例》第5條展示的修訂
 Amendments exhibited under Section 5 of the Town Planning Ordinance

	修訂項目 A1 Amendment Item A1
---------------------------------------------------------------------------------------	------------------------------

備註：因技術性問題，此分區計劃大綱核准圖所顯示的範圍超過《一手住宅物業銷售條例》的規定。
 Note: Due to technical reasons, this approved outline zoning plan has shown more than the area required under the Residential Properties (First-hand Sales) Ordinance.

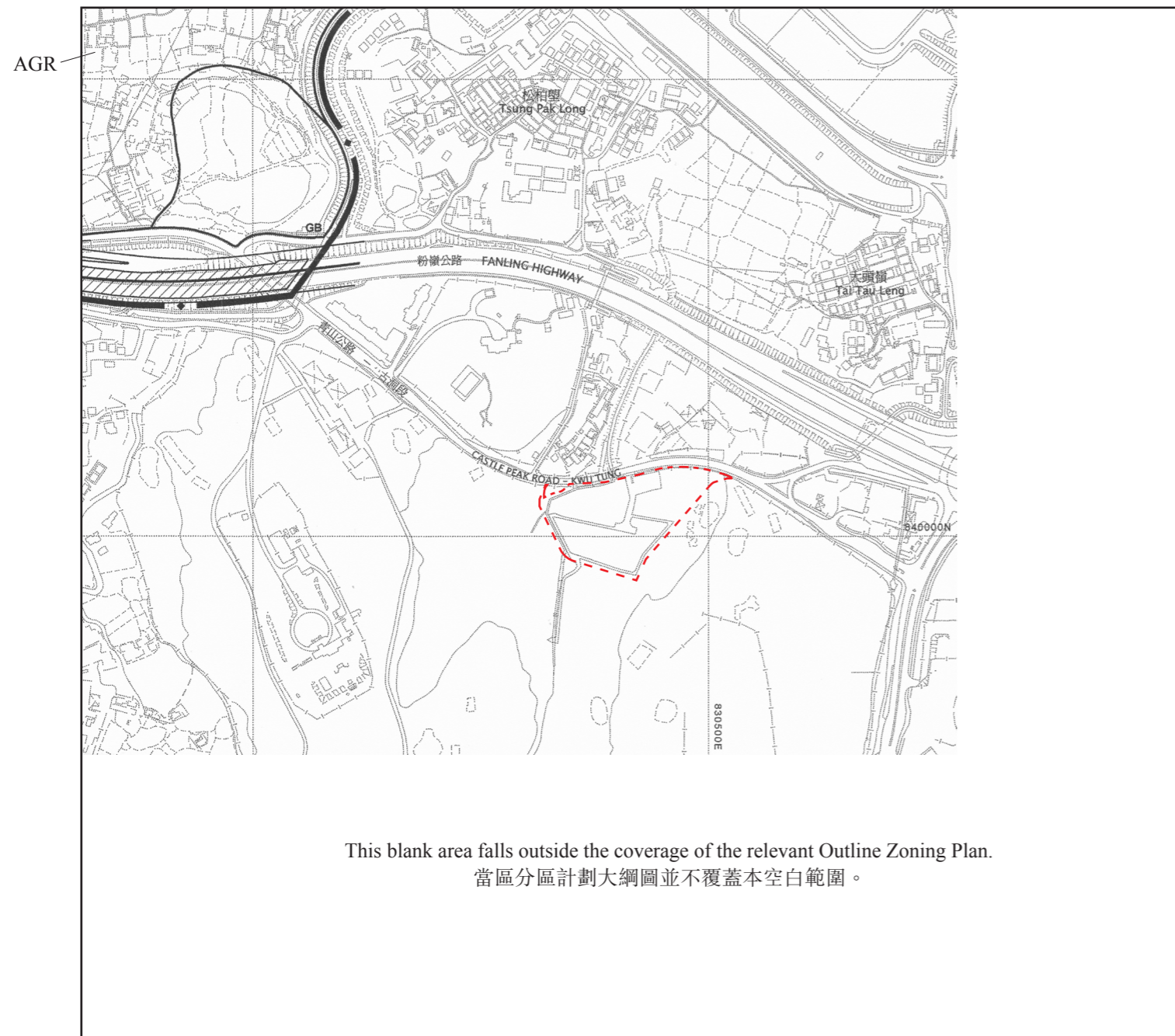

摘錄自 2015 年 6 月 19 日刊憲之古洞北分區計劃大綱核准圖，圖則編號為 S/KTN/2。
Excerpt from the approved Kwu Tung North Outline Zoning Plan with Plan No. S/KTN/2, gazetted on 19th June 2015.

圖例 NOTATION

地帶 ZONES

- AGR 農業
Agricultural
- GB 綠化地帶
Green Belt

交通 COMMUNICATIONS

- ==+== 主要道路及路口
Major Road and Junction

其他 MISCELLANEOUS

- . — 規劃範圍界線
Boundary of Planning Scheme

發展項目的位置
Location of the Development

比例： 0 100 200 300 400 500
Scale:
米 metres

備註：因技術性問題，此分區計劃大綱核准圖所顯示的範圍超過《一手住宅物業銷售條例》的規定。
Note : Due to technical reasons, this approved outline zoning plan has shown more than the area required under the Residential Properties (First-hand Sales) Ordinance.

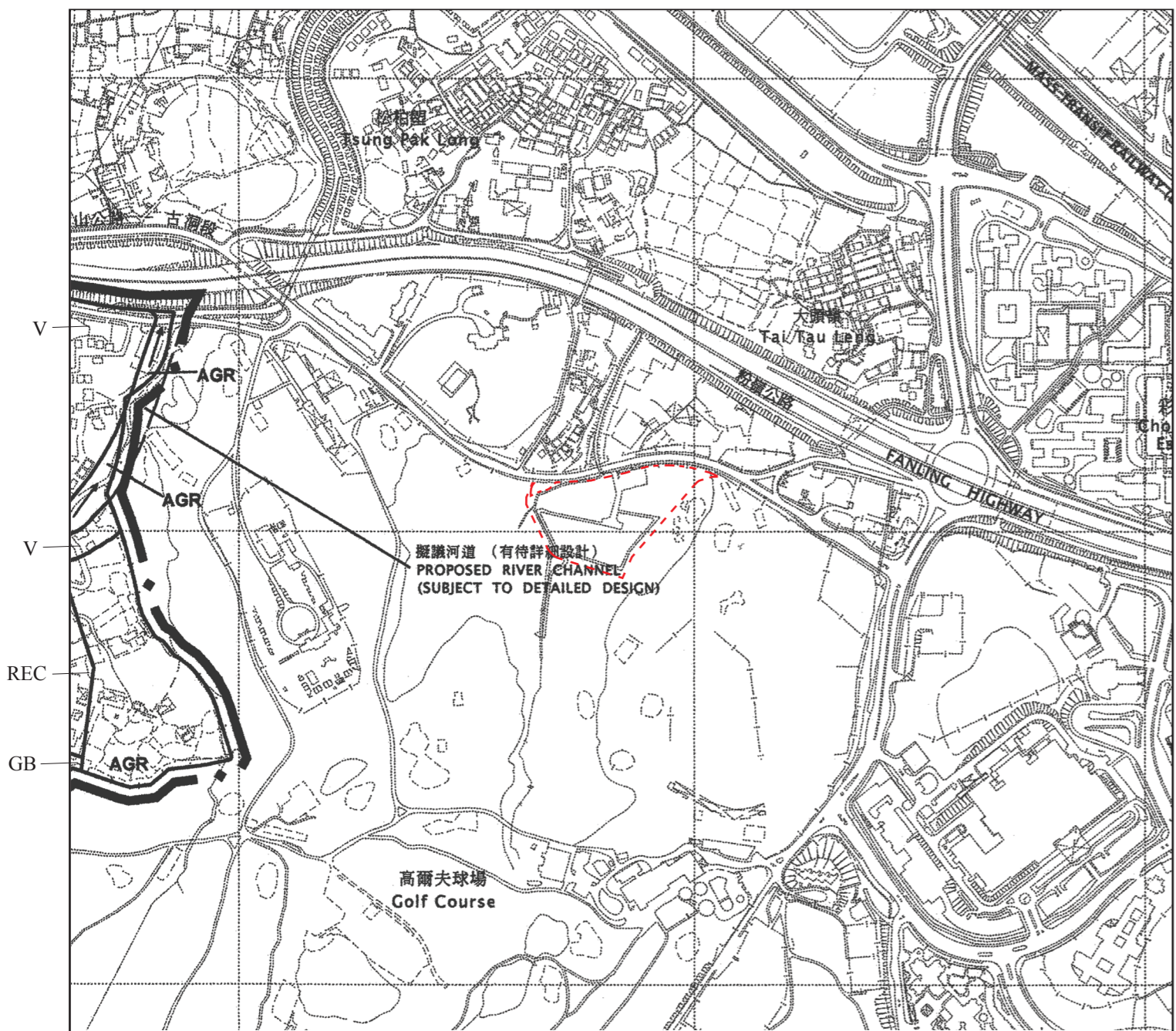

摘錄自 2018 年 2 月 9 日刊憲之古洞南分區計劃大綱核准圖，圖則編號為 S/NE-KTS/16。
 Excerpt from the approved Kwu Tung South Outline Zoning Plan with Plan No. S/NE-KTS/16, gazetted on 9th February 2018.

圖例 NOTATION

- 地帶 ZONES
- V 鄉村式發展
Village Type Development
 - REC 康樂
Recreation
 - AGR 農業
Agricultural
 - GB 綠化地帶
Green Belt

交通 COMMUNICATIONS

- 主要道路及路口
Major Road and Junction

其他 MISCELLANEOUS

- 規劃範圍界線
Boundary of Planning Scheme

發展項目的位置
Location of the Development

比例： 0 100 200 300 400 500
 Scale:
 米 metres

備註：因技術性問題，此分區計劃大綱圖所顯示的範圍超過《一手住宅物業銷售條例》的規定。
 Note: Due to technical reasons, this outline zoning plan has shown more than the area required under the Residential Properties (First-hand Sales) Ordinance.

9 發展項目的布局圖 LAYOUT PLAN OF THE DEVELOPMENT

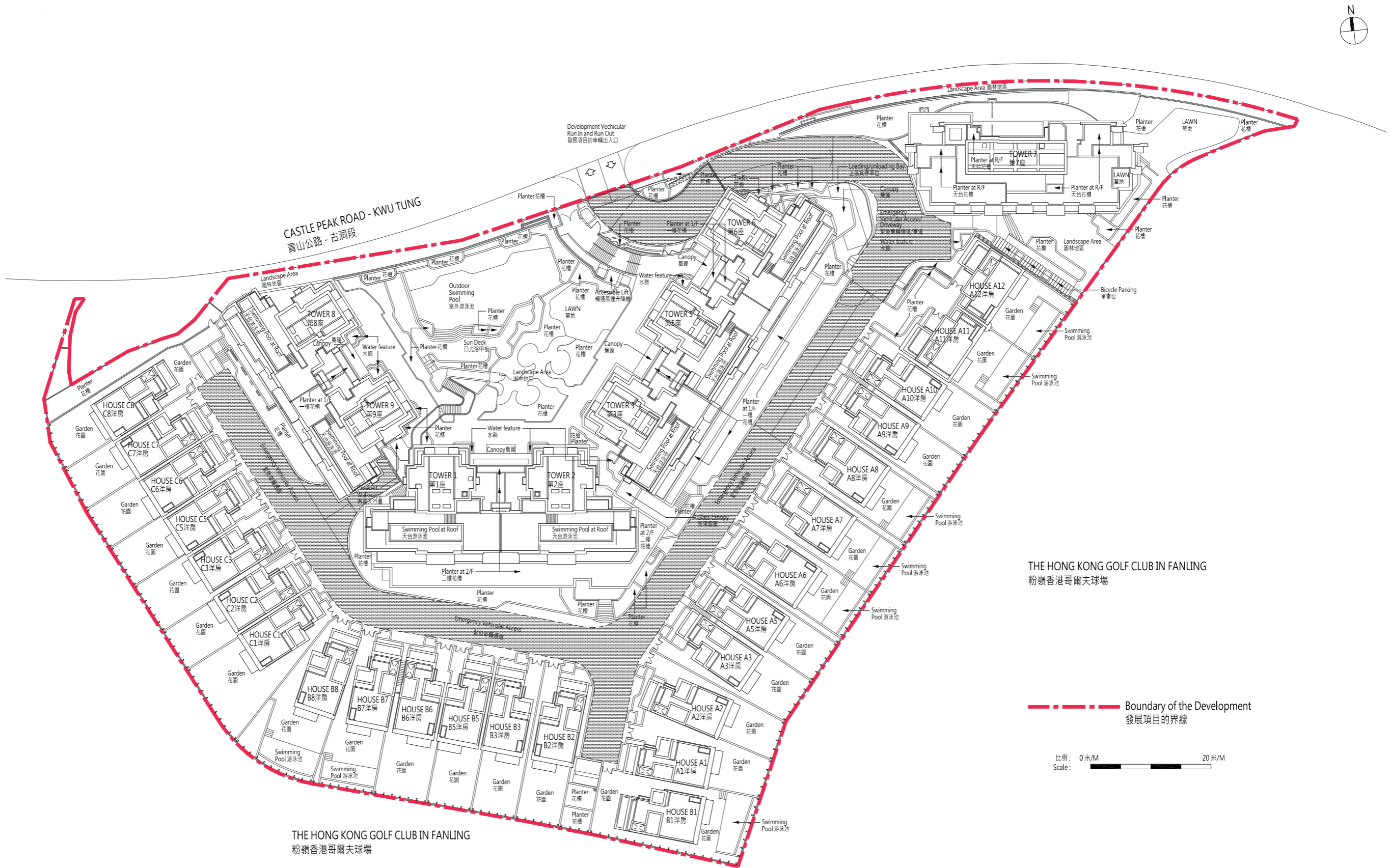

由發展項目的認可人士提供的該等建築物及設施的預計落成日期為2019年5月8日。
The estimated date of completion of these buildings and facilities, as provided by the authorized person for the development is 8th May 2019.

10 發展項目的住宅物業的樓面平面圖

FLOOR PLANS OF RESIDENTIAL PROPERTIES IN THE DEVELOPMENT

在本頁上之備註和圖例適用於全部的「發展項目的住宅物業的樓面平面圖」頁數。

The remarks and legends on this page apply to all pages of "Floor plans of residential properties in the development".

樓面平面圖圖例

Legends of the Floor Plans

A/C UNIT	=	冷氣機 Air-conditioning Unit	DIN.	=	飯廳 Dining Room
A/C	=	冷氣機 Air-conditioner	DN	=	落 Down
A/C PLATFORM	=	冷氣機平台 Air-conditioner Platform	ELV.	=	特低壓電線槽 Extra-Low Voltage Cable Duct
ARCH. FEATURE	=	建築裝飾 Architectural Feature	ELV. RISER DUCT	=	特低壓電線管道 Extra-Low Voltage Cable Riser Duct
BAL.	=	露台 Balcony	E.A.D.	=	排風管 Exhaust Air Duct
BATH	=	浴室 Bathroom	E.M.C.	=	電錶櫃 Electric Meter Cabinet
M.B.R.	=	主人睡房 Master Bedroom	E.D.	=	電線管道 Electric Cable Duct
B.R.	=	睡房 Bedroom	F.H.	=	消防栓 Fire Hydrant
B.R. 1	=	睡房 1 Bedroom 1	LAV.	=	洗手間 Lavatory
B.R. 2	=	睡房 2 Bedroom 2	LIV.	=	客廳 Living Room
B.R. 3	=	睡房 3 Bedroom 3	M. BATH	=	主人浴室 Master Bathroom
B.R. 4	=	睡房 4 Bedroom 4	OPEN KIT.	=	開放式廚房 Open Kitchen
ELECT. METER RM.	=	電錶房 Electric Meter Room	R.S.M.R. RM.	=	垃圾及物料回收室 Refuse Storage and Material Recovery Room
H.R.	=	消防喉轆 Hose Reel	UP	=	上 Up
KIT.	=	廚房 Kitchen	W.M.C.	=	水錶櫃 Water Meter Cabinet
LIV./DIN./B.R.	=	客廳/飯廳/睡房 Living Room / Dining Room / Bedroom	WRD.	=	水壓管道 Water Duct
P.D.	=	管道 Pipe Duct	LIFT MACH. ROOM	=	電梯機房 Lift Machine Room
STORE	=	儲物房 Store Room		=	隨樓附送嵌入式裝置 Built-in fittings provided in the flats
U.P.	=	工作平台 Utility Platform			
DOG HOUSE FOR GAS HEATER & PIPES OF A/C	=	熱水爐及冷氣管道的機電管道 Dog house for gas heater & pipes of air-conditioner			

備註：

1. 部分住宅單位的露台、工作平台、平台、天台或外牆或設有外露之公用喉管，或外牆裝飾板內藏之公用喉管。
2. 部分住宅單位內之部分天花或有跌級樓板，用以安裝上層之機電設備或配合上層之結構、建築設計及 / 或裝修設計上的需要。
3. 部分住宅單位內或設有假陣或假天花用以安裝冷氣喉管及 / 或其他機電設備。
4. 平面圖所列之數字以毫米標示之建築結構尺寸。
5. 平台空白位置為供維修大廈設備使用的公用地方。
6. 各住宅物業的樓面平面圖內所展示之裝置及設備的圖標如浴缸、洗面盆、座廁、淋浴間、洗滌盆、櫃 (如有) 等乃根據最新經批准的建築圖則擬備，其形狀、尺寸、比例或與實際提供的裝置及設備存在差異，僅供示意及參考之用。

Remarks:

1. Common pipes exposed or enclosed in cladding may be located at the balcony, utility platform, flat roof, roof or external wall of some residential Flats.
2. There may be sunken slabs at some parts of the ceiling inside some residential flats for the installation of mechanical and electrical services of the floor above or due to the structural, architectural and/or decoration design requirements of the floor above.
3. There may be ceiling bulkheads or false ceiling inside some residential flats for the installation of air-conditioning conduits and/or other mechanical and electrical services.
4. The dimensions of the floor plans are all structural dimensions in millimeter.
5. Blank areas on flat roof are common areas for building facility maintenance.
6. Those icons of fittings and fitments shown on the floor plans of residential properties like bathtubs, wash basins, water closets, shower cubicles, sink units, cabinets (if any) etc. are prepared in accordance with the latest approved building plans. Their shapes, dimensions, scales may be differed from the fittings and fitments actually provided and they are for indication and reference only.

10 發展項目的住宅物業的樓面平面圖 FLOOR PLANS OF RESIDENTIAL PROPERTIES IN THE DEVELOPMENT

A1洋房 House A1

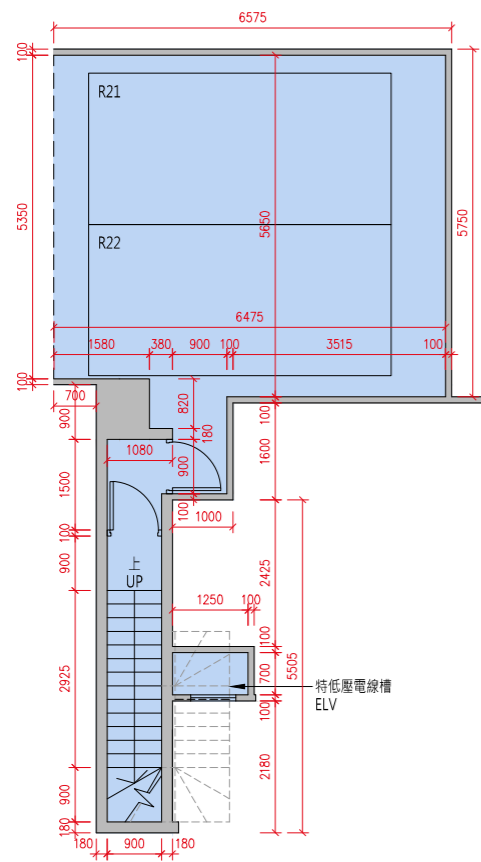

地庫1樓平面圖
B1/F Floor Plan

貼鄰住客停車位的面積 (不計算入停車位面積或實用面積) :

A1 洋房地庫 1 樓為 12.748 平方米 (137 平方呎)。

Area adjoining residential parking space (not included in the area of parking space or saleable area): House A1 on B1/F is 12.748 sq.m. (137sq.ft.)

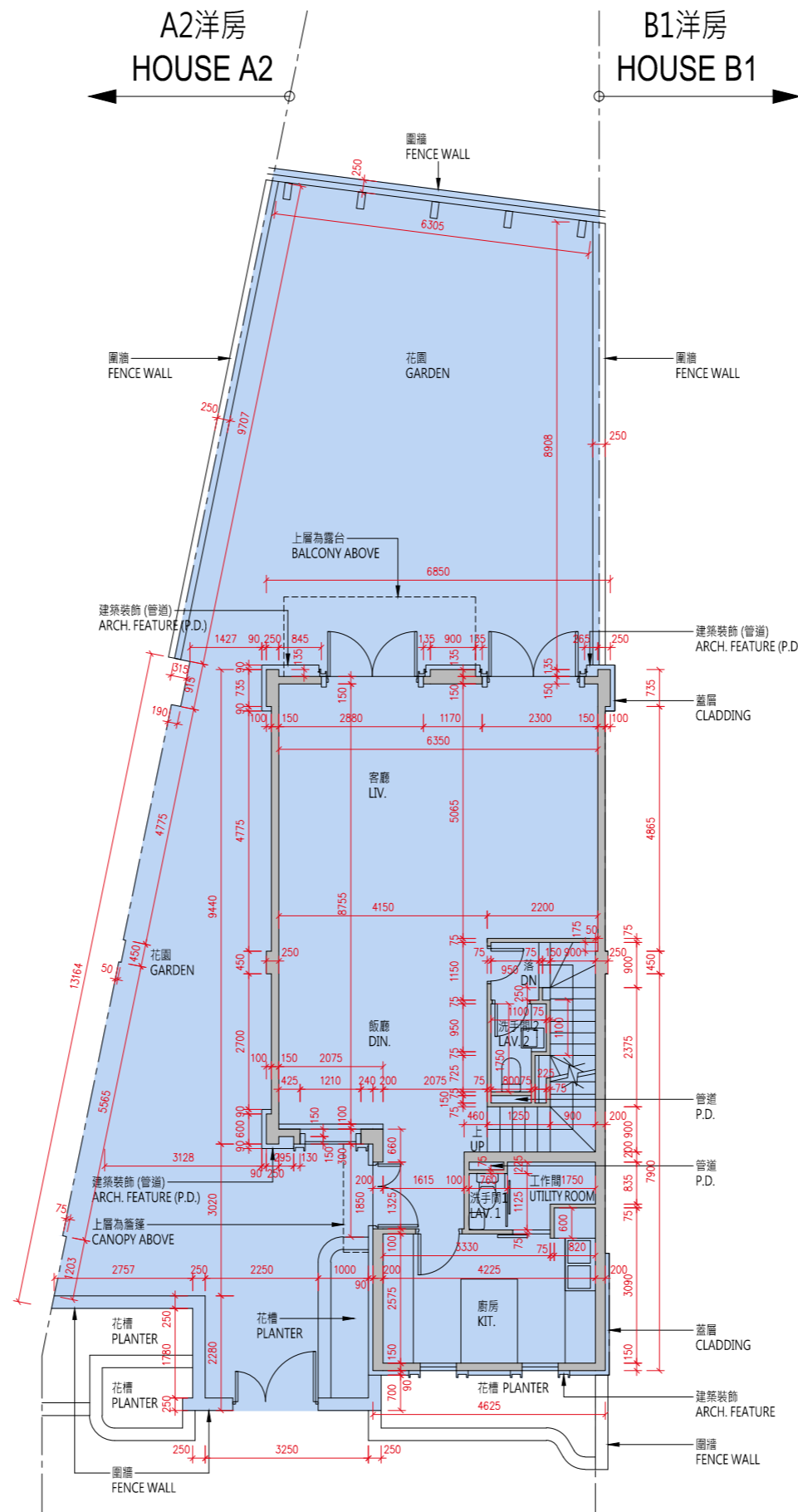

地下平面圖
G/F Floor Plan

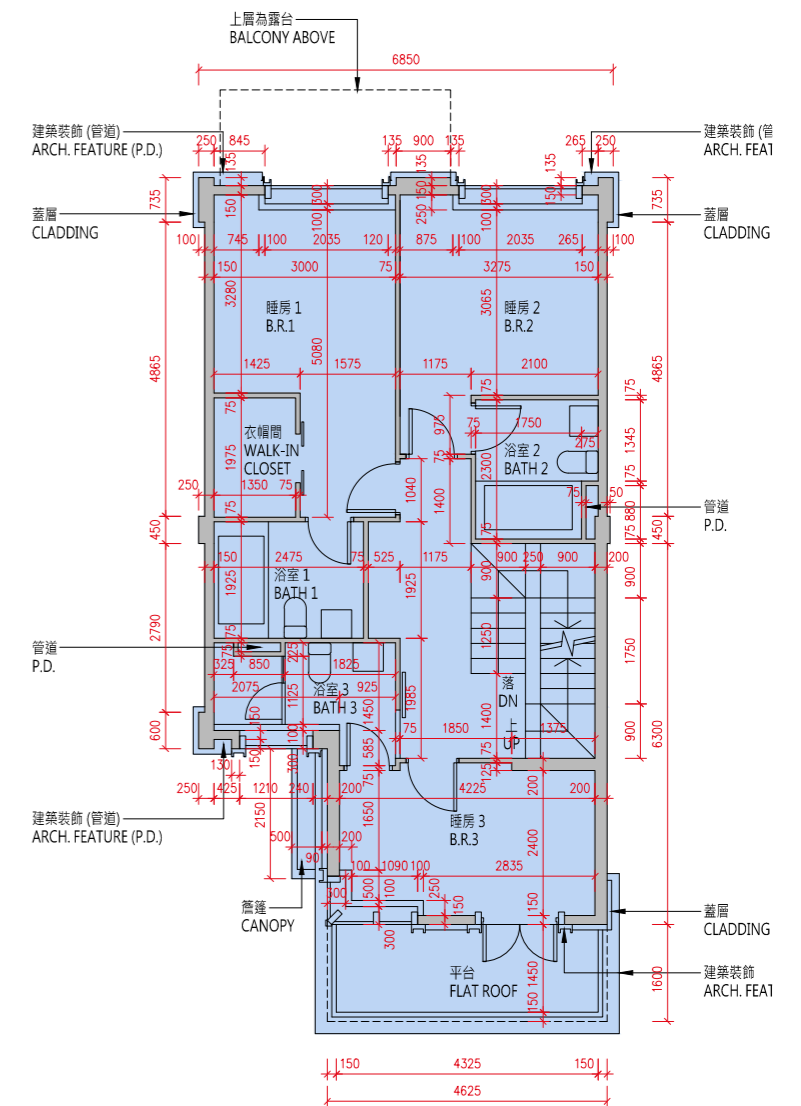

1樓平面圖
1/F Floor Plan

比例 :0米/M 5米/M
Scale :

A1洋房
House A1

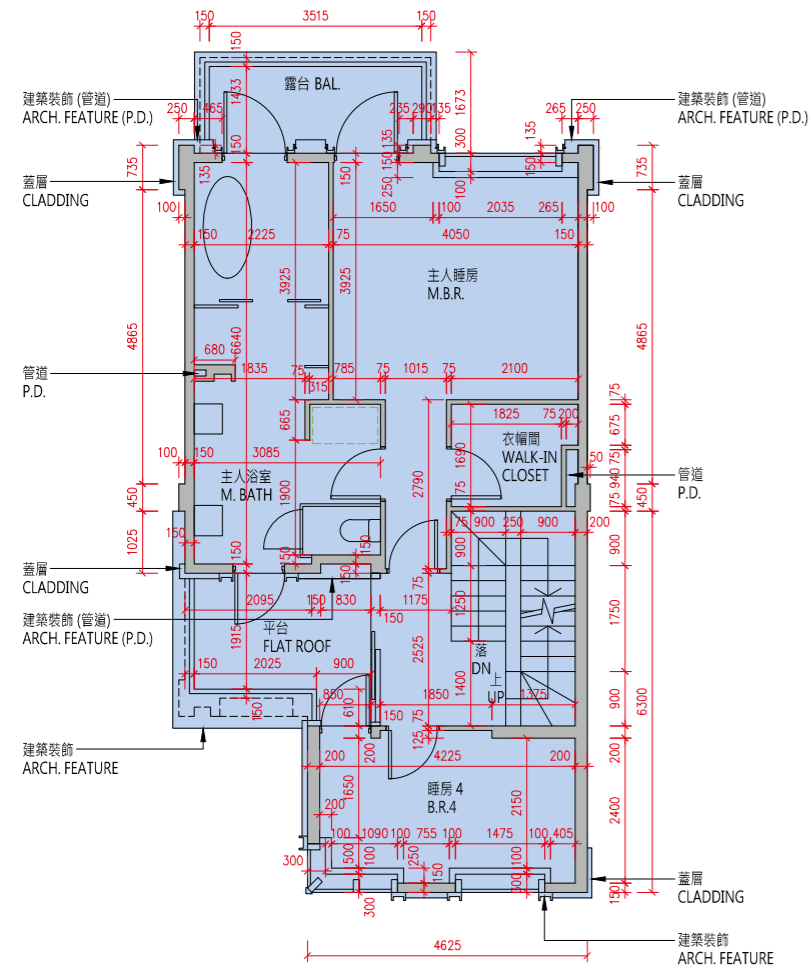
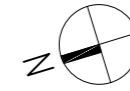

2樓平面圖
2/F Floor Plan

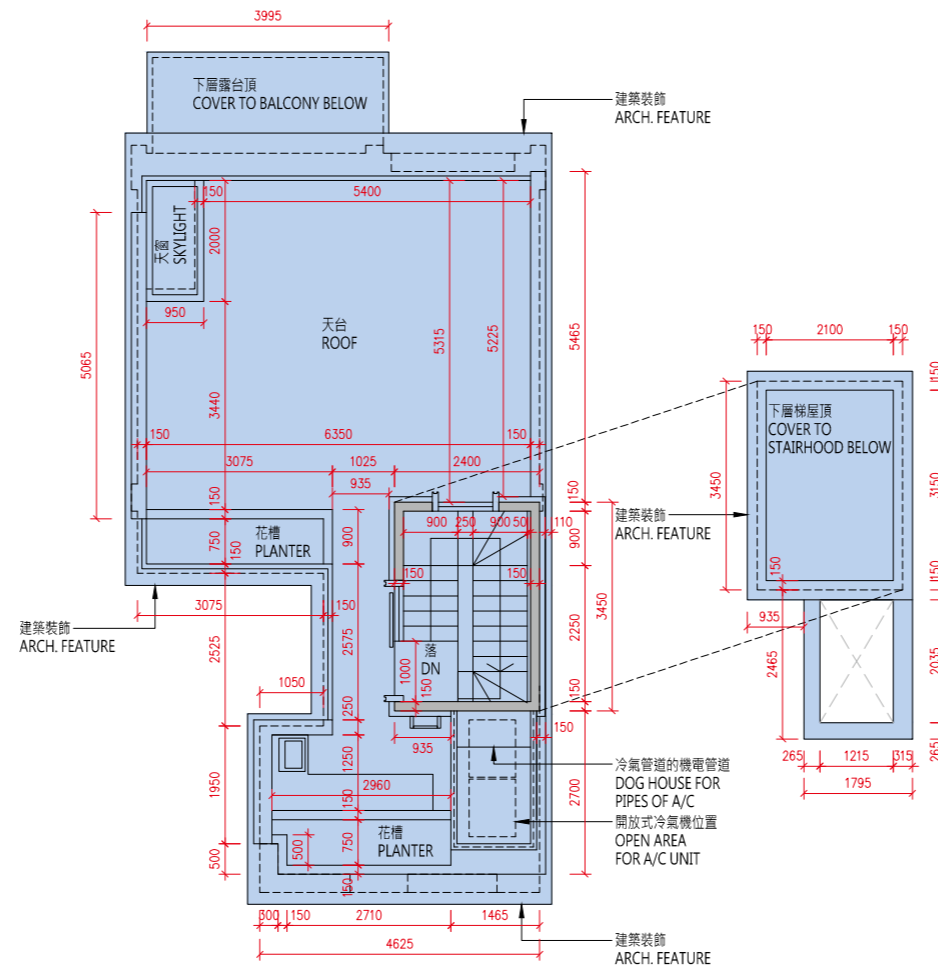

天台平面圖
Roof Floor Plan

比例：0米/M 5米/M
Scale :

樓層 Floor	地庫1樓 B1/F	地下 G/F	1樓 1/F	2樓 2/F	天台 Roof
層與層之間的高度 (毫米) Floor to Floor Height (mm)	3720, 4110, 4350, 4650	3750, 3970, 4000	3050, 3080, 3125, 3300	3500	N/A
樓板 (不包括灰泥) 的厚度 (毫米) Thickness of Floor Slab (excluding plaster) (mm)	200	150, 200	150, 200	150, 200	N/A

10 發展項目的住宅物業的樓面平面圖

FLOOR PLANS OF RESIDENTIAL PROPERTIES IN THE DEVELOPMENT

備註：

- (1) 批地文件特別條件第 8(d) 條規定：-
「(d) 在該地段已建成或擬建的住宅單位數目須不少於 515，並就本 (d) 分條而言：
 - (i) 一座擬作為單一家庭住宅的獨立屋、半獨立屋或排屋均被視為一個住宅單位；
 - (ii) 署長就獨立屋、半獨立屋或排屋是否構成或擬作為單一家庭住宅所作的決定將為最終決定，並對買方構成約束力；及
 - (iii) 署長就什麼構成一個住宅單位所作的決定將為最終決定，並對買方構成約束力。」
- (2) 公契及管理協議第 85 條規定：-
「管理人須在管理處備存一份由地政總署署長或任何其他不時替代其位的政府主管當局根據本公契附表三第 43 條所發出的同意的資料記錄，以供所有業主免費查閱及自費影印該資料記錄，並繳付合理費用。所有就此收取的費用一律撥入特別基金。」
- (3) 公契及管理協議附表三第 43 條規定：-
「43. 除非事先獲得地政總署署長或任何其他不時替代其位的政府主管當局的書面同意，否則任何業主不得進行或允許或容忍他人進行任何與住宅單位相關而可導致該住宅單位內部相連及通往任何毗連或毗鄰的住宅單位的工程，包括但不限於拆卸或更改任何分隔牆或任何樓板或天台樓板或任何間隔結構。而地政總署署長具有全權酌情給予同意或拒絕同意，倘若給予同意，業主須遵從地政總署署長按其全權酌情附加的任何條款及條件（包括支付費用）。」
- (4) 發展項目內所提供的住宅單位總數目為 590。
- (5) 平面圖所列的數字為以毫米標示之建築結構尺寸。
- (6) 因住宅物業的較高樓層的結構牆的厚度遞減，較高樓層的內部面積，一般比較低樓層的內部面積稍大。
- (7) 請參閱本售樓說明書第 20 頁為住宅物業樓面平面圖而設之備註及名詞及簡稱的圖例。

Notes:

- (1) Special Condition No. (8)(d) of the Land Grant stipulates that: -
“(d) the total number of residential units erected or to be erected on the lot shall not be less than 515, and for the purposes of this sub-clause (d):
 - (i) a detached, semi-detached or terraced house which is intended for use as a single family residence shall be regarded as a residential unit;
 - (ii) the decision of the Director as to whether a detached, semi-detached or terraced house constitutes or is intended for use as a single family residence shall be final and binding on the Purchaser; and
 - (iii) the decision of the Director as to what constitutes a residential unit shall be final and binding on the Purchaser.”
- (2) Clause 85 of the Deed of Mutual Covenant incorporating Management Agreement stipulates that: -
“85. The Manager shall deposit in the management office the record provided by the Director of Lands or any other Government authority in place of him from time to time of the information relating to the consent given under Clause 43 of the Third Schedule hereto for inspection by all Owners free of charge and taking copies at their own expense and on payment of a reasonable charge. All charges received shall be credited to the Special Fund.”
- (3) Clause 43 of the Third Schedule to the Deed of Mutual Covenant incorporating Management Agreement stipulates that: -
“43. No Owner shall carry out or permit or suffer to be carried out any works in connection with any Residential Unit, including but not limited to demolition or alteration of any partition wall or any floor or roof slab or any partition structure, which will result in such Residential Unit being internally linked to and accessible from any adjoining or adjacent Residential Unit, except with the prior written consent of the Director of Lands or any other Government authority in place of him from time to time, which consent may be given or withheld at his absolute discretion and if given, may be subject to such terms and conditions (including payment of fees) as may be imposed by him at his absolute discretion.”
- (4) The total number of residential units provided in the development is 590.
- (5) The dimensions in floor plans are all structural dimensions in millimeter.
- (6) The internal areas of the residential properties on the upper floors will generally be slightly larger than those on the lower floors because of the reducing thickness of the structural walls on the upper floors.
- (7) Please refer to page 20 of this sales brochure for the remarks and legends of the terms and abbreviations for the floor plans of residential properties.

A2洋房
House A2

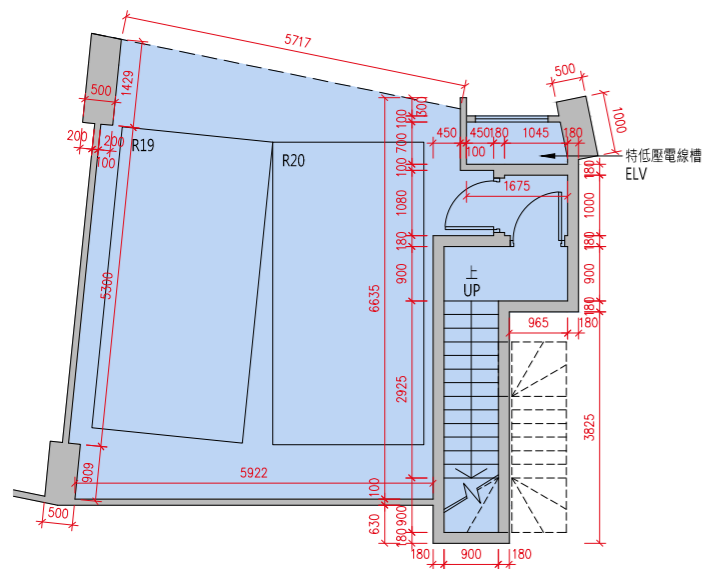

地庫1樓平面圖
B1/F Floor Plan

貼鄰住客停車位的面積 (不計算入停車位面積或實用面積) :
A2 洋房地庫 1 樓為 16.974 平方米 (183 平方呎)。
Area adjoining residential parking space (not included in the area of parking space or saleable area): House A2 on B1/F is 16.974 sq.m. (183sq.ft.)

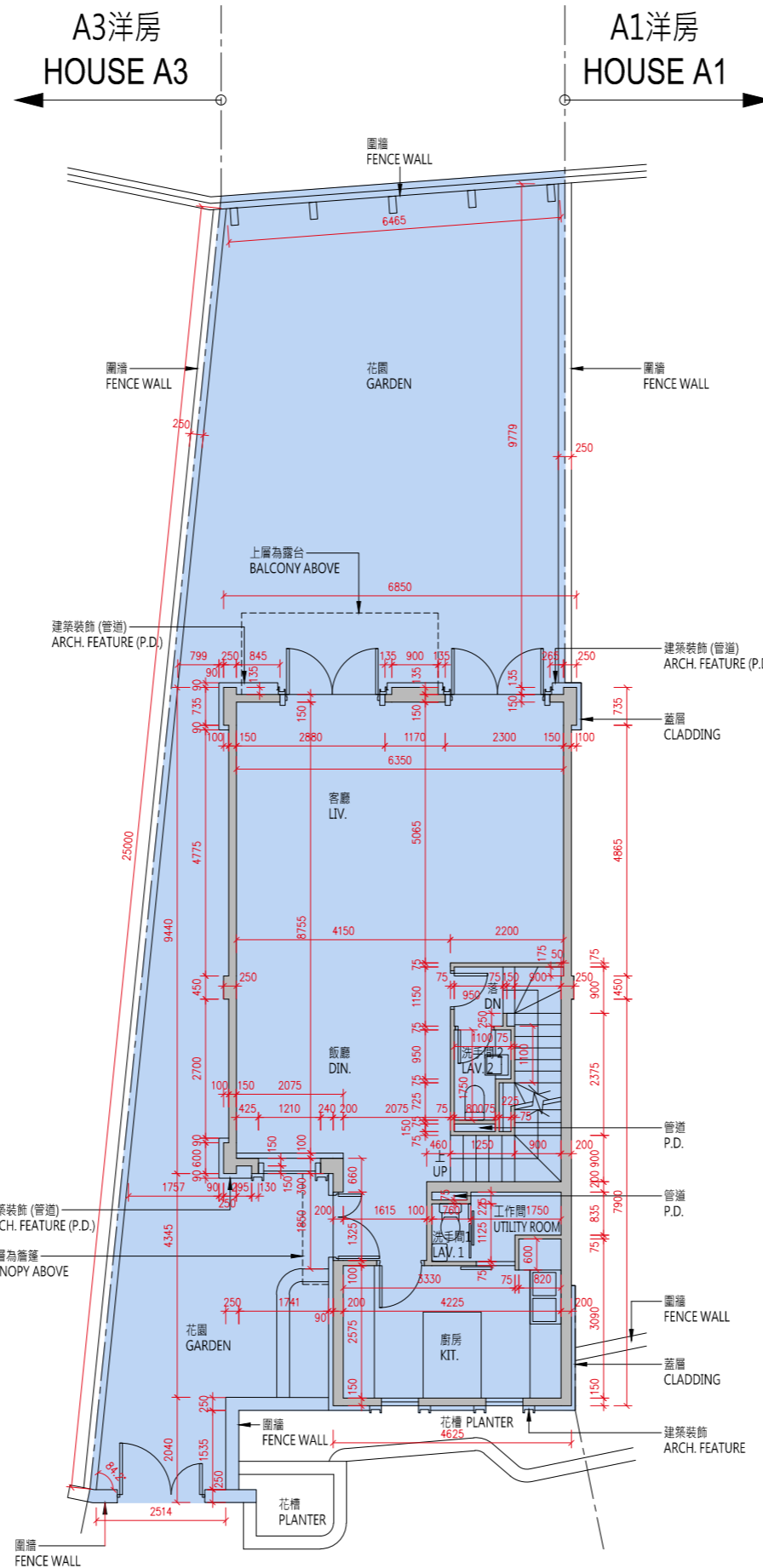

地下平面圖
G/F Floor Plan

A1洋房
HOUSE A1

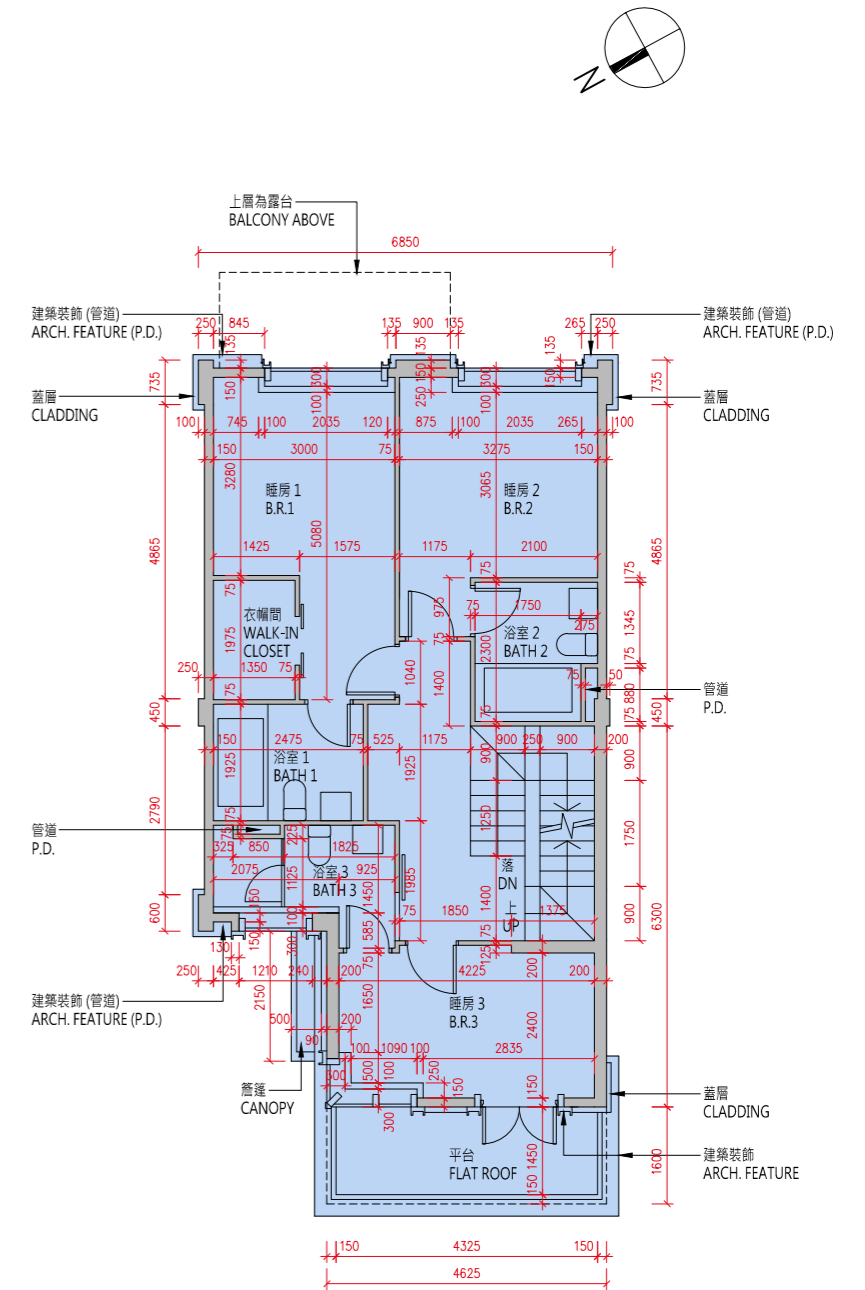

1樓平面圖
1/F Floor Plan

比例 :0米/M 5米/M
Scale :

10 發展項目的住宅物業的樓面平面圖 FLOOR PLANS OF RESIDENTIAL PROPERTIES IN THE DEVELOPMENT

A2洋房 House A2

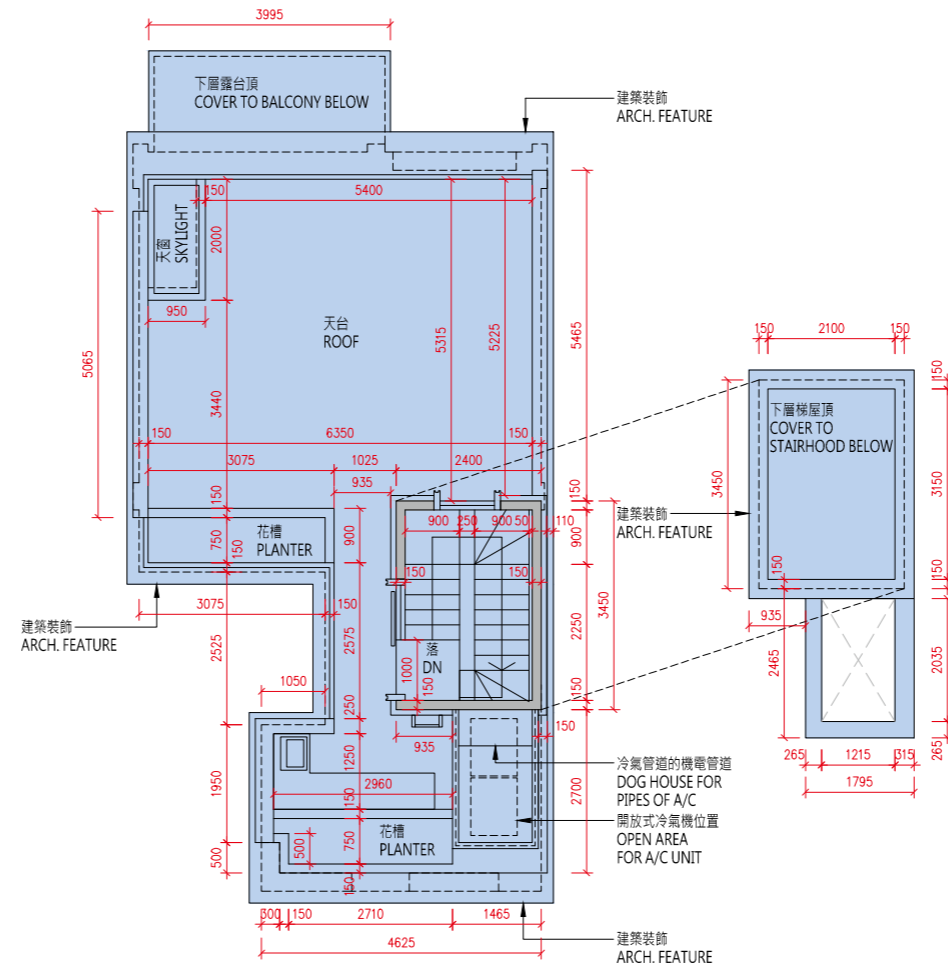
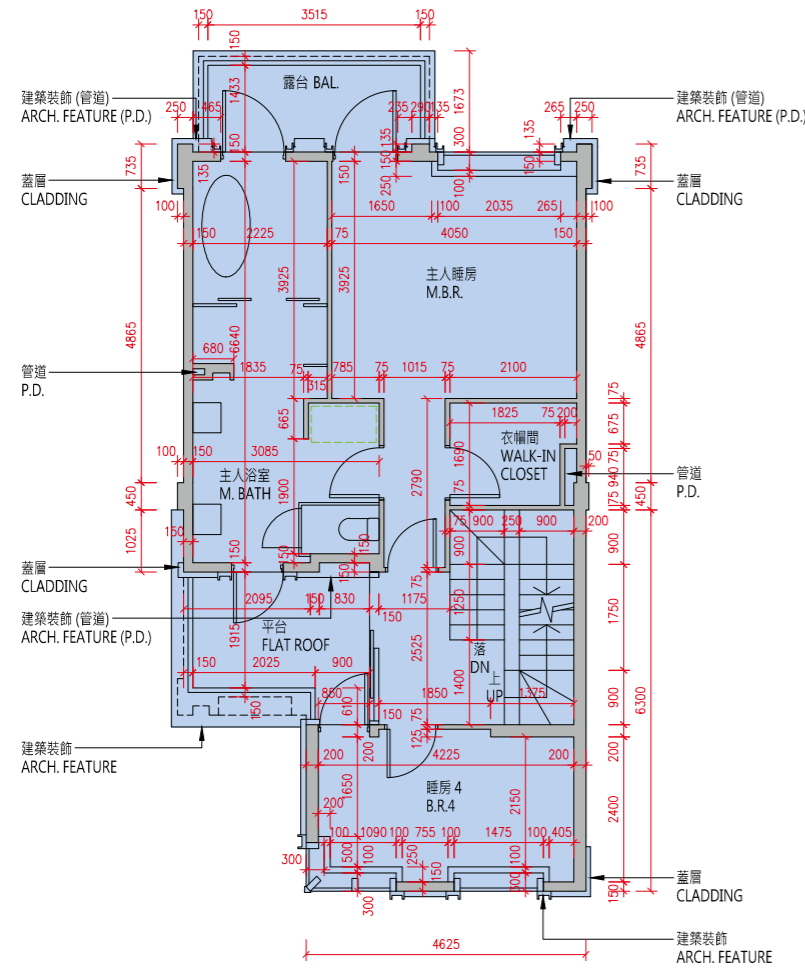
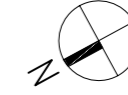

比例：0米/M 5米/M
Scale:

樓層 Floor	地庫1樓 B1/F	地下 G/F	1樓 1/F	2樓 2/F	天台 Roof
層與層之間的高度 (毫米) Floor to Floor Height (mm)	4350, 5060	3750, 3970, 4000	3050, 3080, 3125, 3300	3500	N/A
樓板 (不包括灰泥) 的厚度 (毫米) Thickness of Floor Slab (excluding plaster) (mm)	200	150, 200	150, 200	150, 200	N/A

備註：

(1) 批地文件特別條件第 8(d) 條規定：-

「(d) 在該地段已建成或擬建的住宅單位數目須不少於 515，並就本 (d) 分條而言：

- (i) 一座擬作為單一家庭住宅的獨立屋、半獨立屋或排屋均被視為一個住宅單位；
- (ii) 署長就獨立屋、半獨立屋或排屋是否構成或擬作為單一家庭住宅所作的決定將為最終決定，並對買方構成約束力；及
- (iii) 署長就什麼構成一個住宅單位所作的決定將為最終決定，並對買方構成約束力。」

(2) 公契及管理協議第 85 條規定：-

「管理人須在管理處備存一份由地政總署署長或任何其他不時替代其位的政府主管當局根據本公契附表三第 43 條所發出的同意的資料記錄，以供所有業主免費查閱及自費影印該資料記錄，並繳付合理費用。所有就此收取的費用一律撥入特別基金。」

(3) 公契及管理協議附表三第 43 條規定：-

「43. 除非事先獲得地政總署署長或任何其他不時替代其位的政府主管當局的書面同意，否則任何業主不得進行或允許或容忍他人進行任何與住宅單位相關而可導致該住宅單位內部相連及通往任何毗連或毗鄰的住宅單位的工程，包括但不限於拆卸或更改任何分隔牆或任何樓板或天台樓板或任何間隔結構。而地政總署署長具有全權酌情給予同意或拒絕同意，倘若給予同意，業主須遵從地政總署署長按其全權酌情附加的任何條款及條件（包括支付費用）。」

(4) 發展項目內所提供的住宅單位總數目為 590。

(5) 平面圖所列的數字為以毫米標示之建築結構尺寸。

(6) 因住宅物業的較高樓層的結構牆的厚度遞減，較高樓層的內部面積，一般比較低樓層的內部面積稍大。

(7) 請參閱本售樓說明書第 20 頁為住宅物業樓面平面圖而設之備註及名詞及簡稱的圖例。

Notes:

(1) Special Condition No. (8)(d) of the Land Grant stipulates that: -

“(d) the total number of residential units erected or to be erected on the lot shall not be less than 515, and for the purposes of this sub-clause (d):

- (i) a detached, semi-detached or terraced house which is intended for use as a single family residence shall be regarded as a residential unit;
- (ii) the decision of the Director as to whether a detached, semi-detached or terraced house constitutes or is intended for use as a single family residence shall be final and binding on the Purchaser; and
- (iii) the decision of the Director as to what constitutes a residential unit shall be final and binding on the Purchaser.”

(2) Clause 85 of the Deed of Mutual Covenant incorporating Management Agreement stipulates that: -

“85. The Manager shall deposit in the management office the record provided by the Director of Lands or any other Government authority in place of him from time to time of the information relating to the consent given under Clause 43 of the Third Schedule hereto for inspection by all Owners free of charge and taking copies at their own expense and on payment of a reasonable charge. All charges received shall be credited to the Special Fund.”

(3) Clause 43 of the Third Schedule to the Deed of Mutual Covenant incorporating Management Agreement stipulates that: -

“43. No Owner shall carry out or permit or suffer to be carried out any works in connection with any Residential Unit, including but not limited to demolition or alteration of any partition wall or any floor or roof slab or any partition structure, which will result in such Residential Unit being internally linked to and accessible from any adjoining or adjacent Residential Unit, except with the prior written consent of the Director of Lands or any other Government authority in place of him from time to time, which consent may be given or withheld at his absolute discretion and if given, may be subject to such terms and conditions (including payment of fees) as may be imposed by him at his absolute discretion.”

(4) The total number of residential units provided in the development is 590.

(5) The dimensions in floor plans are all structural dimensions in millimeter.

(6) The internal areas of the residential properties on the upper floors will generally be slightly larger than those on the lower floors because of the reducing thickness of the structural walls on the upper floors.

(7) Please refer to page 20 of this sales brochure for the remarks and legends of the terms and abbreviations for the floor plans of residential properties.

10 發展項目的住宅物業的樓面平面圖 FLOOR PLANS OF RESIDENTIAL PROPERTIES IN THE DEVELOPMENT

A3洋房 House A3

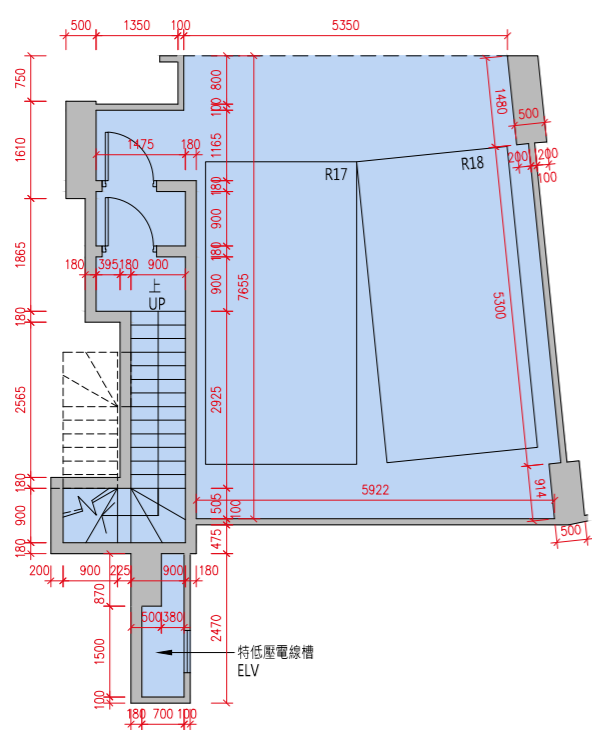

地庫1樓平面圖
B1/F Floor Plan

貼鄰住客停車位的面積 (不計算入停車位面積或實用面積) :
A3 洋房地庫 1 樓為 20.531 平方米 (221 平方呎)。
Area adjoining residential parking space (not included in the area of parking
space or saleable area): House A3 on B1/F is 20.531sq.m. (221sq.ft.)

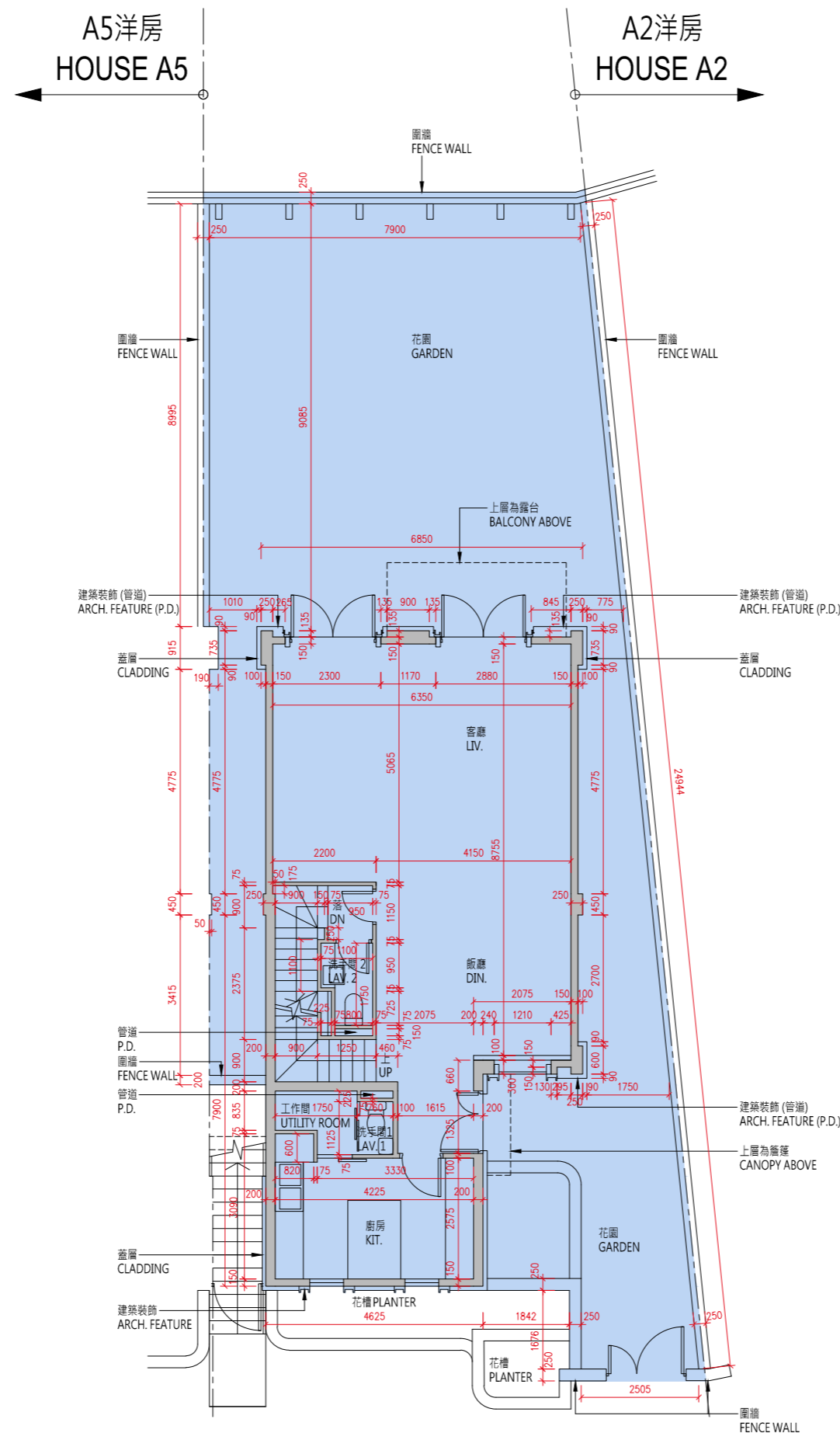

地下平面圖
G/F Floor Plan

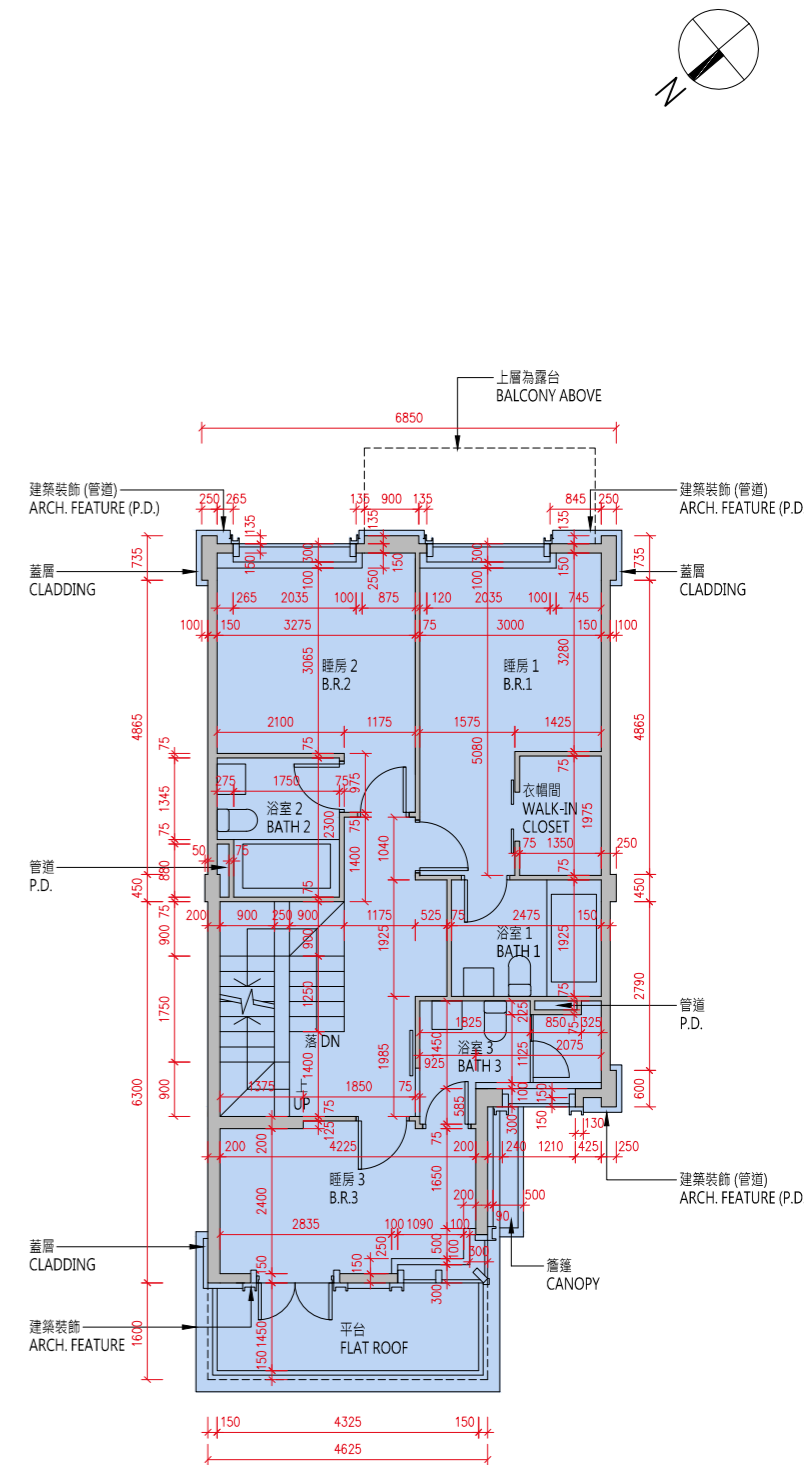

1樓平面圖
1/F Floor Plan

比例 : 0米/M 5米/M
Scale :

A3洋房
House A3

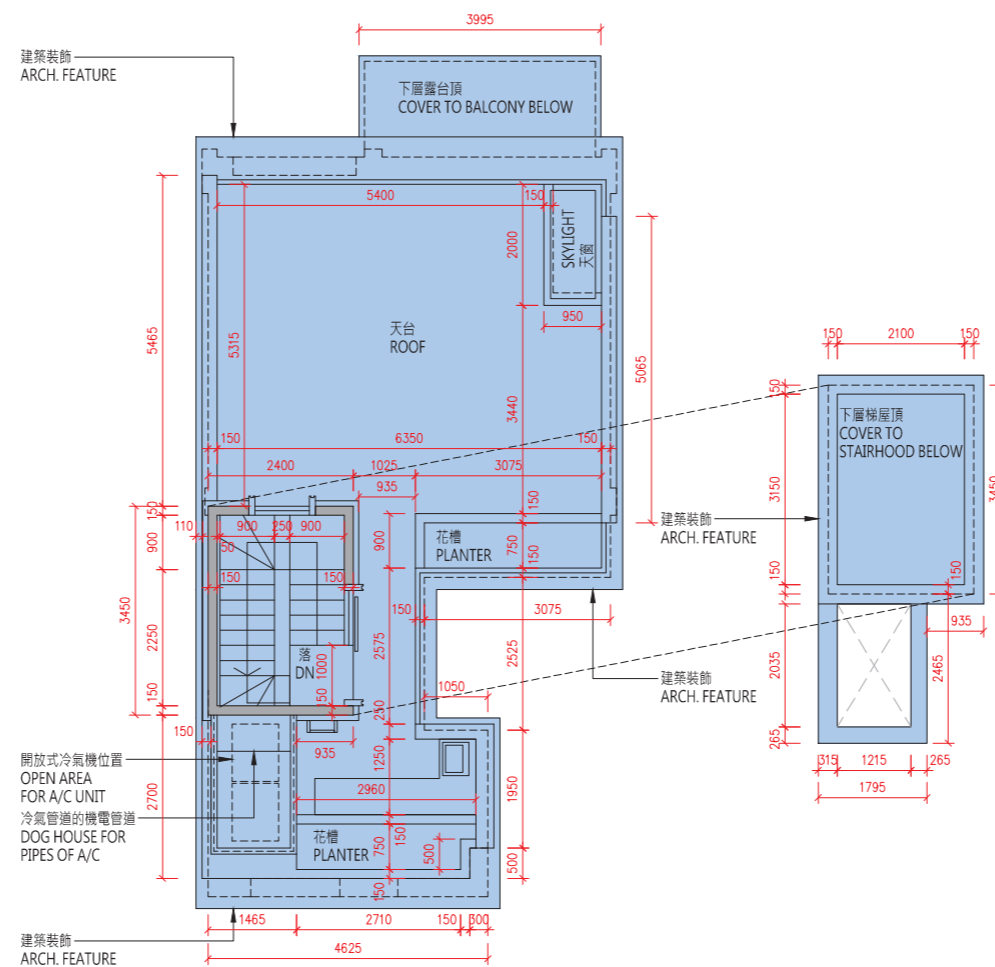
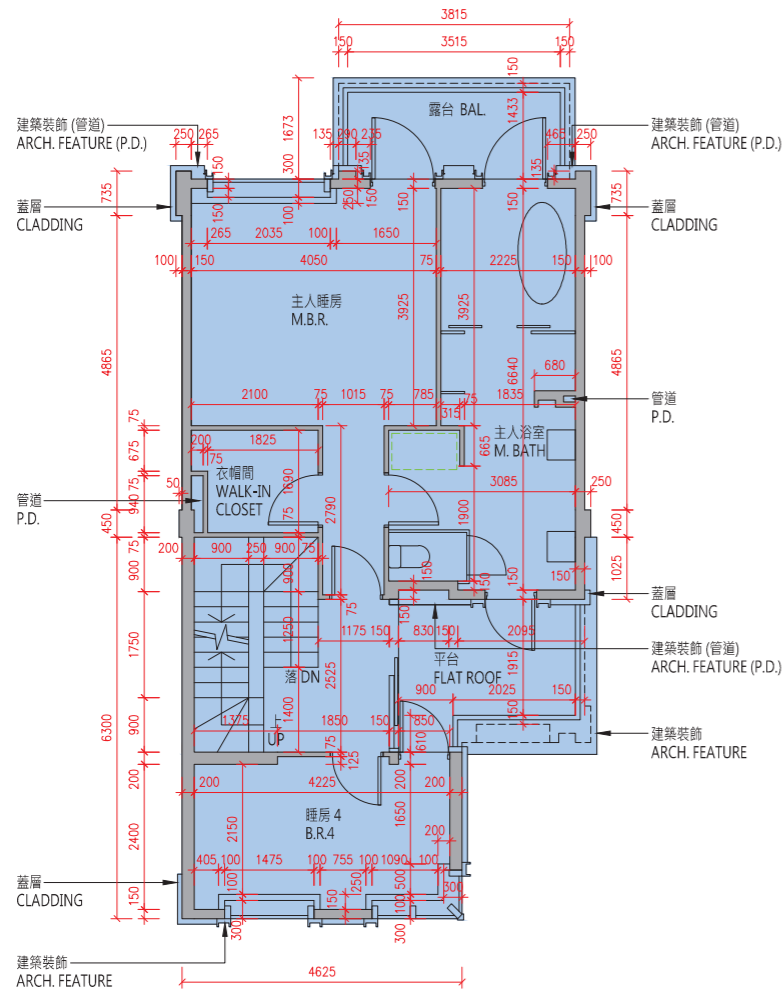

比例：0米/M 5米/M
Scale : 5米/M

樓層 Floor	地庫1樓 B1/F	地下 G/F	1樓 1/F	2樓 2/F	天台 Roof
層與層之間的高度 (毫米) Floor to Floor Height (mm)	4350, 4650, 5060	3750, 3970, 4000	3050, 3080, 3125, 3300	3500	N/A
樓板 (不包括灰泥) 的厚度 (毫米) Thickness of Floor Slab (excluding plaster) (mm)	200	150, 200	150, 200	150, 200	N/A

10 發展項目的住宅物業的樓面平面圖

FLOOR PLANS OF RESIDENTIAL PROPERTIES IN THE DEVELOPMENT

備註：

- (1) 批地文件特別條件第 8(d) 條規定：-
「(d) 在該地段已建成或擬建的住宅單位數目須不少於 515，並就本 (d) 分條而言：
 - (i) 一座擬作為單一家庭住宅的獨立屋、半獨立屋或排屋均被視為一個住宅單位；
 - (ii) 署長就獨立屋、半獨立屋或排屋是否構成或擬作為單一家庭住宅所作的決定將為最終決定，並對買方構成約束力；及
 - (iii) 署長就什麼構成一個住宅單位所作的決定將為最終決定，並對買方構成約束力。」
- (2) 公契及管理協議第 85 條規定：-
「管理人須在管理處備存一份由地政總署署長或任何其他不時替代其位的政府主管當局根據本公契附表三第 43 條所發出的同意的資料記錄，以供所有業主免費查閱及自費影印該資料記錄，並繳付合理費用。所有就此收取的費用一律撥入特別基金。」
- (3) 公契及管理協議附表三第 43 條規定：-
「43. 除非事先獲得地政總署署長或任何其他不時替代其位的政府主管當局的書面同意，否則任何業主不得進行或允許或容忍他人進行任何與住宅單位相關而可導致該住宅單位內部相連及通往任何毗連或毗鄰的住宅單位的工程，包括但不限於拆卸或更改任何分隔牆或任何樓板或天台樓板或任何間隔結構。而地政總署署長具有全權酌情給予同意或拒絕同意，倘若給予同意，業主須遵從地政總署署長按其全權酌情附加的任何條款及條件（包括支付費用）。」
- (4) 發展項目內所提供的住宅單位總數目為 590。
- (5) 平面圖所列的數字為以毫米標示之建築結構尺寸。
- (6) 因住宅物業的較高樓層的結構牆的厚度遞減，較高樓層的內部面積，一般比較低樓層的內部面積稍大。
- (7) 請參閱本售樓說明書第 20 頁為住宅物業樓面平面圖而設之備註及名詞及簡稱的圖例。

Notes:

- (1) Special Condition No. (8)(d) of the Land Grant stipulates that: -
“(d) the total number of residential units erected or to be erected on the lot shall not be less than 515, and for the purposes of this sub-clause (d):
 - (i) a detached, semi-detached or terraced house which is intended for use as a single family residence shall be regarded as a residential unit;
 - (ii) the decision of the Director as to whether a detached, semi-detached or terraced house constitutes or is intended for use as a single family residence shall be final and binding on the Purchaser; and
 - (iii) the decision of the Director as to what constitutes a residential unit shall be final and binding on the Purchaser.”
- (2) Clause 85 of the Deed of Mutual Covenant incorporating Management Agreement stipulates that: -
“85. The Manager shall deposit in the management office the record provided by the Director of Lands or any other Government authority in place of him from time to time of the information relating to the consent given under Clause 43 of the Third Schedule hereto for inspection by all Owners free of charge and taking copies at their own expense and on payment of a reasonable charge. All charges received shall be credited to the Special Fund.”
- (3) Clause 43 of the Third Schedule to the Deed of Mutual Covenant incorporating Management Agreement stipulates that: -
“43. No Owner shall carry out or permit or suffer to be carried out any works in connection with any Residential Unit, including but not limited to demolition or alteration of any partition wall or any floor or roof slab or any partition structure, which will result in such Residential Unit being internally linked to and accessible from any adjoining or adjacent Residential Unit, except with the prior written consent of the Director of Lands or any other Government authority in place of him from time to time, which consent may be given or withheld at his absolute discretion and if given, may be subject to such terms and conditions (including payment of fees) as may be imposed by him at his absolute discretion.”
- (4) The total number of residential units provided in the development is 590.
- (5) The dimensions in floor plans are all structural dimensions in millimeter.
- (6) The internal areas of the residential properties on the upper floors will generally be slightly larger than those on the lower floors because of the reducing thickness of the structural walls on the upper floors.
- (7) Please refer to page 20 of this sales brochure for the remarks and legends of the terms and abbreviations for the floor plans of residential properties.

A5洋房
House A5

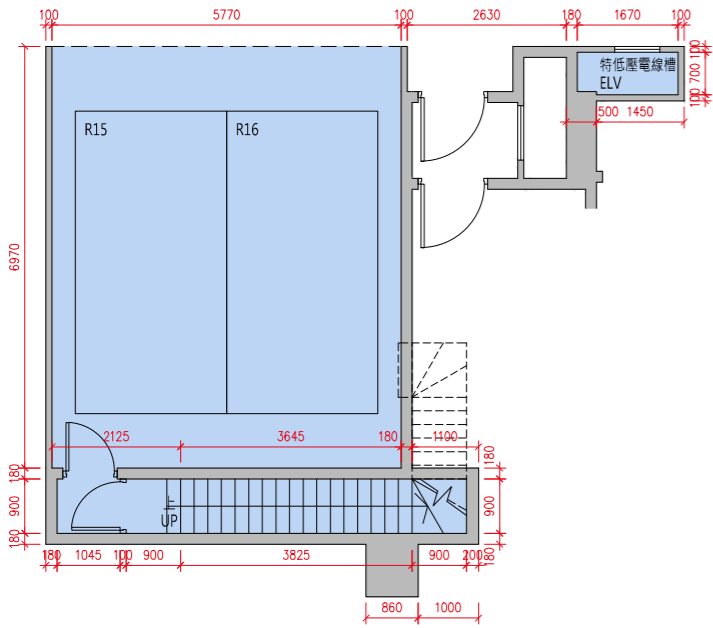

地庫1樓平面圖
B1/F Floor Plan

貼鄰住客停車位的面積 (不計算入停車位面積或實用面積) :
A5 洋房地庫 1 樓為 15.217 平方米 (164 平方呎)。
Area adjoining residential parking space (not included in the area of parking space or saleable area): House A5 on B1/F is 15.217sq.m. (164sq.ft.)

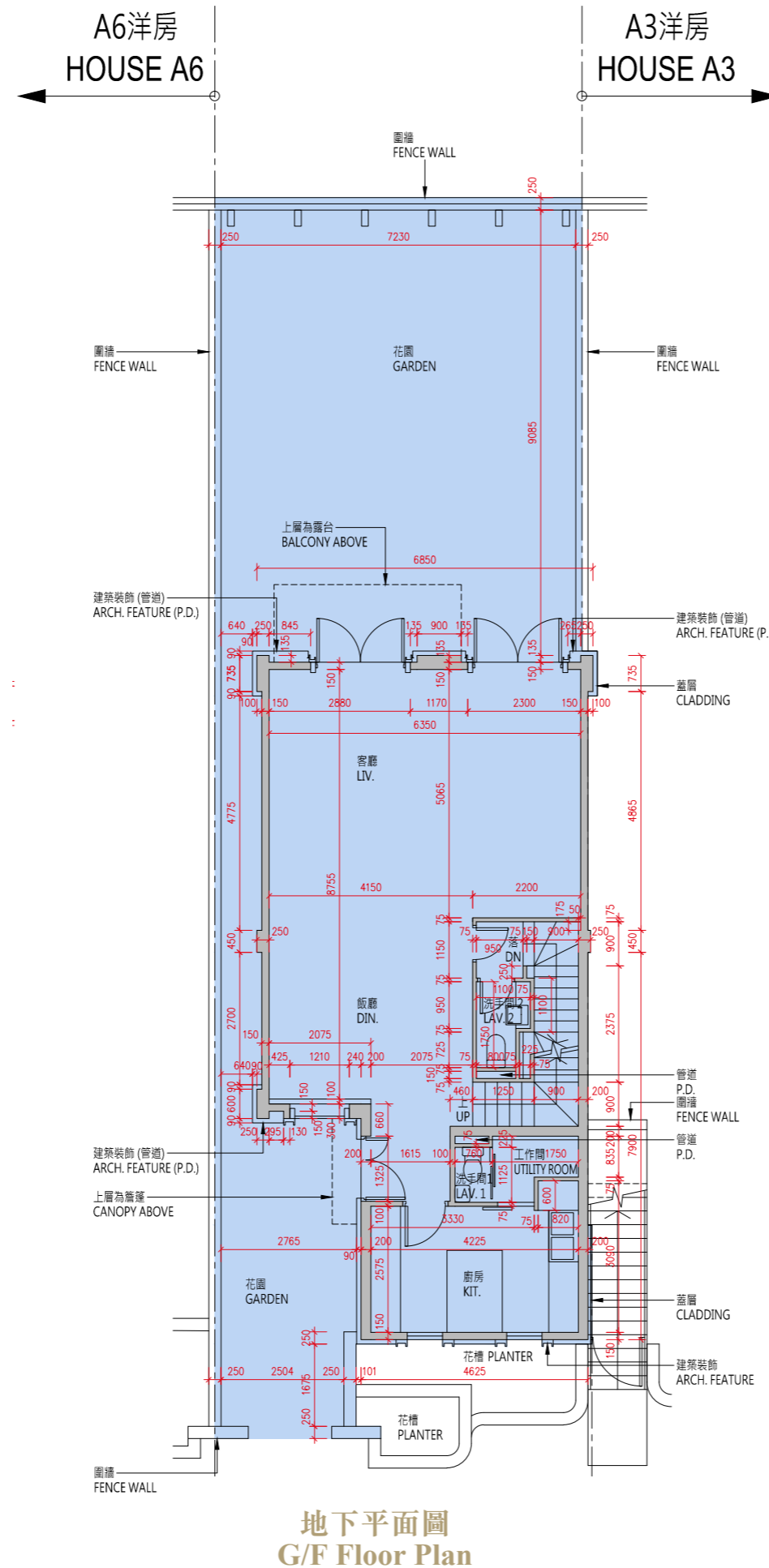

地下平面圖
G/F Floor Plan

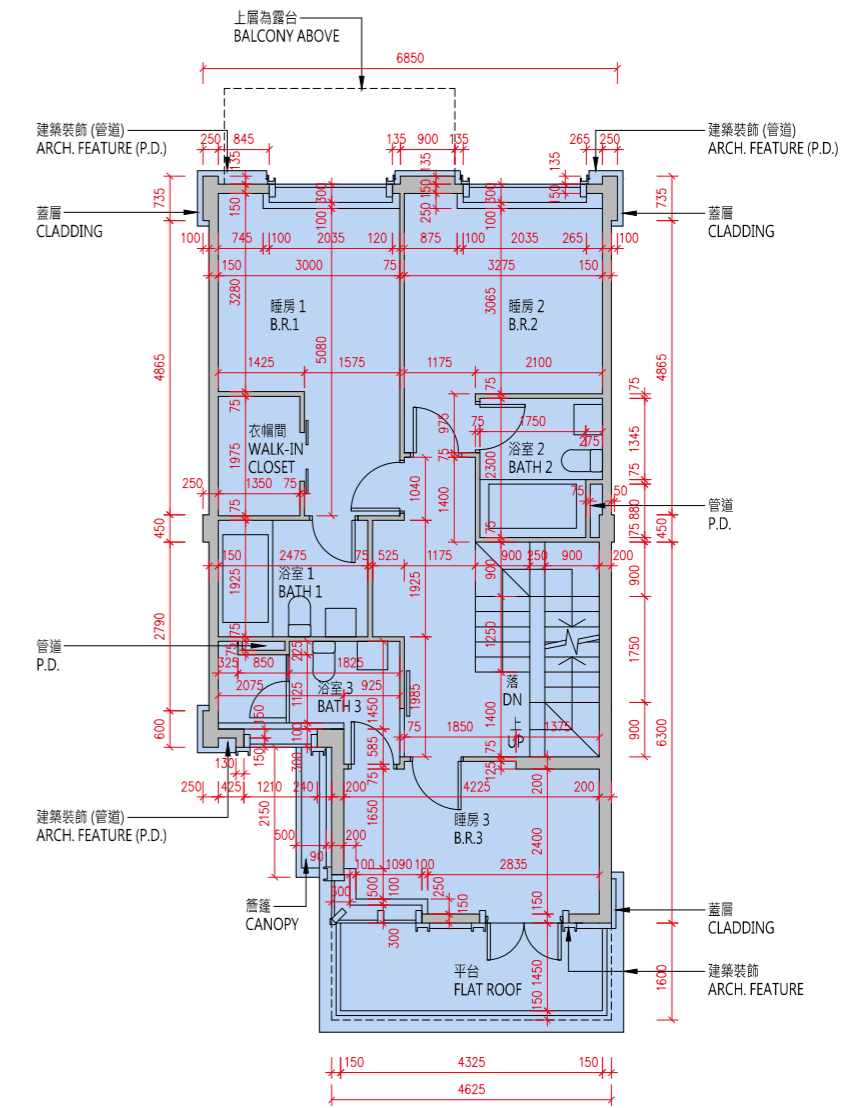

1樓平面圖
1/F Floor Plan

比例 :0米/M 5米/M
Scale : [Scale Bar]

10 發展項目的住宅物業的樓面平面圖 FLOOR PLANS OF RESIDENTIAL PROPERTIES IN THE DEVELOPMENT

A5洋房 House A5

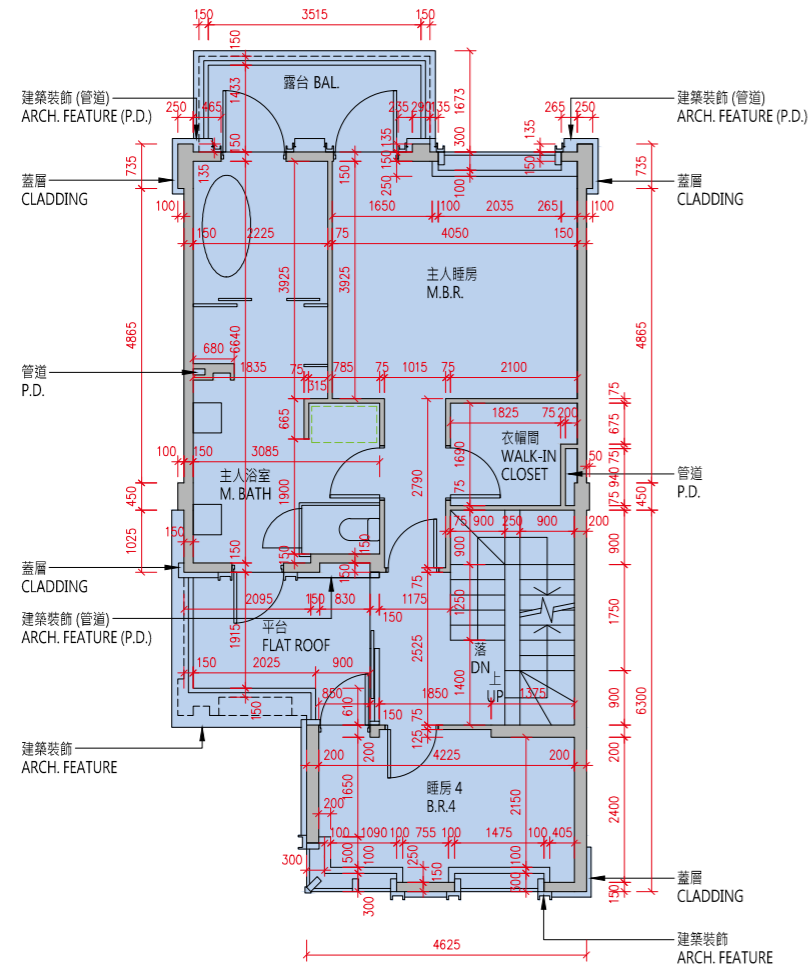
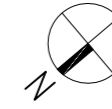

2樓平面圖
2/F Floor Plan

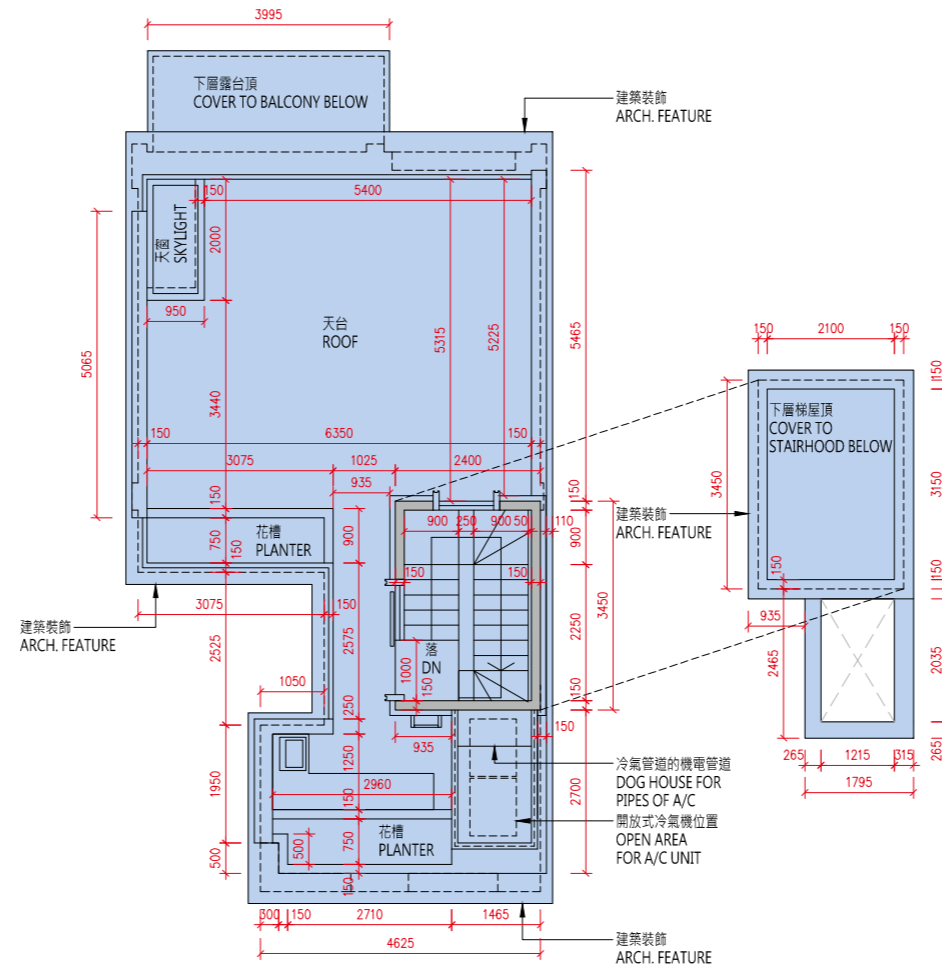

天台平面圖
Roof Floor Plan

比例：0米/M 5米/M
Scale :

樓層 Floor	地庫1樓 B1/F	地下 G/F	1樓 1/F	2樓 2/F	天台 Roof
層與層之間的高度 (毫米) Floor to Floor Height (mm)	4350, 4650, 5060, 5350	3750, 3970, 4000	3050, 3080, 3125, 3300	3500	N/A
樓板 (不包括灰泥) 的厚度 (毫米) Thickness of Floor Slab (excluding plaster) (mm)	200	150, 200	150, 200	150, 200	N/A

備註：

(1) 批地文件特別條件第 8(d) 條規定：-

「(d) 在該地段已建成或擬建的住宅單位數目須不少於 515，並就本 (d) 分條而言：

- (i) 一座擬作為單一家庭住宅的獨立屋、半獨立屋或排屋均被視為一個住宅單位；
- (ii) 署長就獨立屋、半獨立屋或排屋是否構成或擬作為單一家庭住宅所作的決定將為最終決定，並對買方構成約束力；及
- (iii) 署長就什麼構成一個住宅單位所作的決定將為最終決定，並對買方構成約束力。」

(2) 公契及管理協議第 85 條規定：-

「管理人須在管理處備存一份由地政總署署長或任何其他不時替代其位的政府主管當局根據本公契附表三第 43 條所發出的同意的資料記錄，以供所有業主免費查閱及自費影印該資料記錄，並繳付合理費用。所有就此收取的費用一律撥入特別基金。」

(3) 公契及管理協議附表三第 43 條規定：-

「43. 除非事先獲得地政總署署長或任何其他不時替代其位的政府主管當局的書面同意，否則任何業主不得進行或允許或容忍他人進行任何與住宅單位相關而可導致該住宅單位內部相連及通往任何毗連或毗鄰的住宅單位的工程，包括但不限於拆卸或更改任何分隔牆或任何樓板或天台樓板或任何間隔結構。而地政總署署長具有全權酌情給予同意或拒絕同意，倘若給予同意，業主須遵從地政總署署長按其全權酌情附加的任何條款及條件（包括支付費用）。」

(4) 發展項目內所提供的住宅單位總數目為 590。

(5) 平面圖所列的數字為以毫米標示之建築結構尺寸。

(6) 因住宅物業的較高樓層的結構牆的厚度遞減，較高樓層的內部面積，一般比較低樓層的內部面積稍大。

(7) 請參閱本售樓說明書第 20 頁為住宅物業樓面平面圖而設之備註及名詞及簡稱的圖例。

Notes:

(1) Special Condition No. (8)(d) of the Land Grant stipulates that: -

“(d) the total number of residential units erected or to be erected on the lot shall not be less than 515, and for the purposes of this sub-clause (d):

- (i) a detached, semi-detached or terraced house which is intended for use as a single family residence shall be regarded as a residential unit;
- (ii) the decision of the Director as to whether a detached, semi-detached or terraced house constitutes or is intended for use as a single family residence shall be final and binding on the Purchaser; and
- (iii) the decision of the Director as to what constitutes a residential unit shall be final and binding on the Purchaser.”

(2) Clause 85 of the Deed of Mutual Covenant incorporating Management Agreement stipulates that: -

“85. The Manager shall deposit in the management office the record provided by the Director of Lands or any other Government authority in place of him from time to time of the information relating to the consent given under Clause 43 of the Third Schedule hereto for inspection by all Owners free of charge and taking copies at their own expense and on payment of a reasonable charge. All charges received shall be credited to the Special Fund.”

(3) Clause 43 of the Third Schedule to the Deed of Mutual Covenant incorporating Management Agreement stipulates that: -

“43. No Owner shall carry out or permit or suffer to be carried out any works in connection with any Residential Unit, including but not limited to demolition or alteration of any partition wall or any floor or roof slab or any partition structure, which will result in such Residential Unit being internally linked to and accessible from any adjoining or adjacent Residential Unit, except with the prior written consent of the Director of Lands or any other Government authority in place of him from time to time, which consent may be given or withheld at his absolute discretion and if given, may be subject to such terms and conditions (including payment of fees) as may be imposed by him at his absolute discretion.”

(4) The total number of residential units provided in the development is 590.

(5) The dimensions in floor plans are all structural dimensions in millimeter.

(6) The internal areas of the residential properties on the upper floors will generally be slightly larger than those on the lower floors because of the reducing thickness of the structural walls on the upper floors.

(7) Please refer to page 20 of this sales brochure for the remarks and legends of the terms and abbreviations for the floor plans of residential properties.

10 發展項目的住宅物業的樓面平面圖 FLOOR PLANS OF RESIDENTIAL PROPERTIES IN THE DEVELOPMENT

A6洋房
House A6

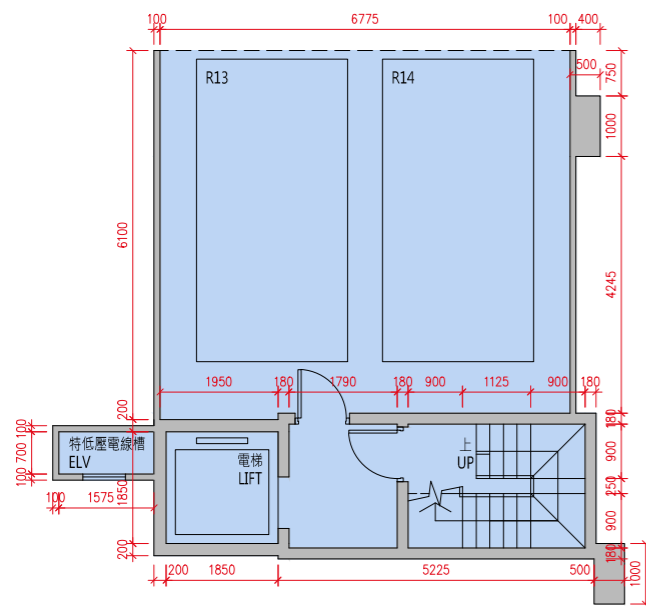

地庫1樓平面圖
B1/F Floor Plan

貼鄰住客停車位的面積 (不計算入停車位面積或實用面積) :
A6 洋房地庫 1 樓為 15.821 平方米 (170 平方呎)。
Area adjoining residential parking space (not included in the area of parking space or saleable area): House A6 on B1/F is 15.821sq.m. (170sq.ft.)

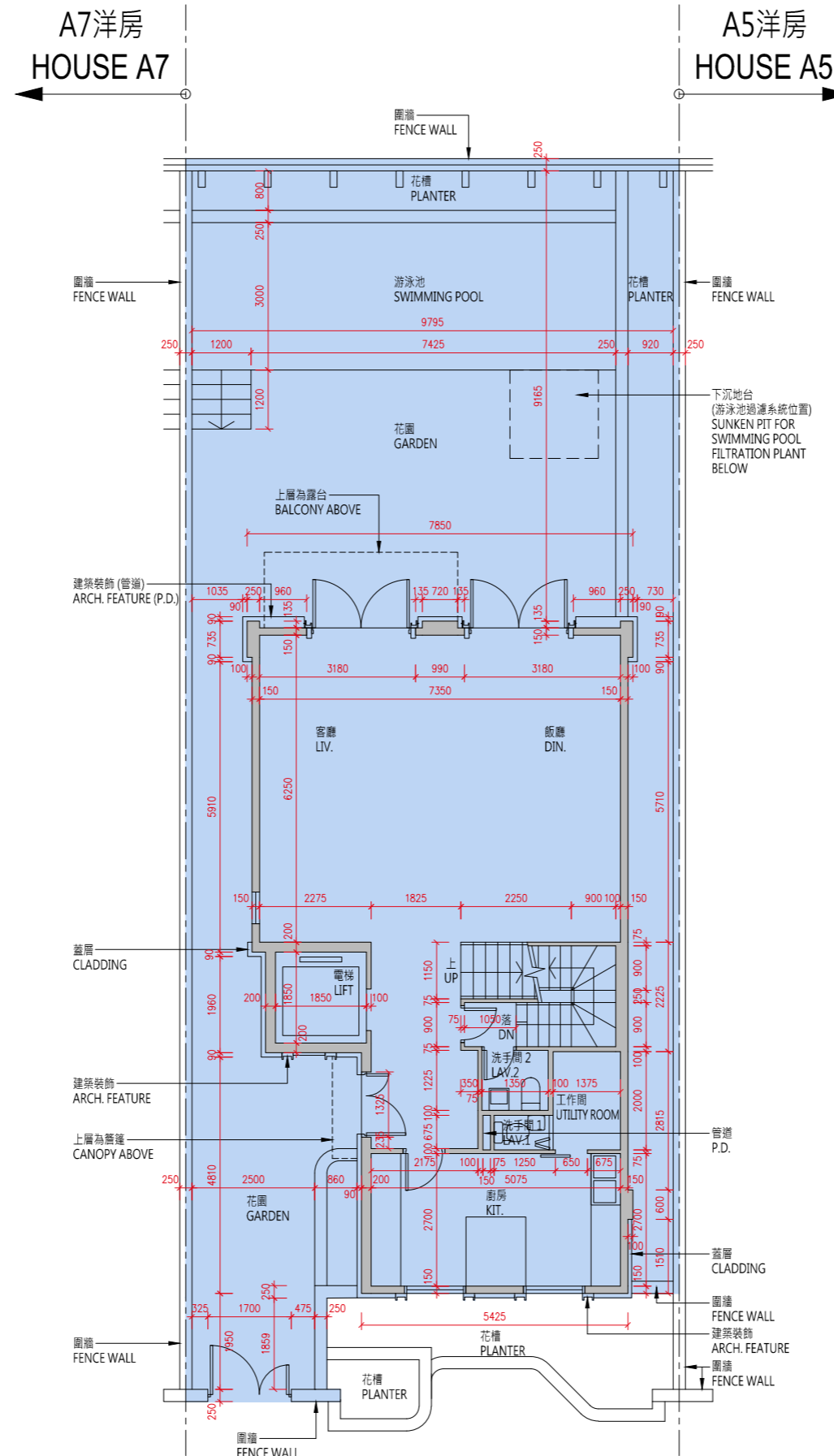

地下平面圖
G/F Floor Plan

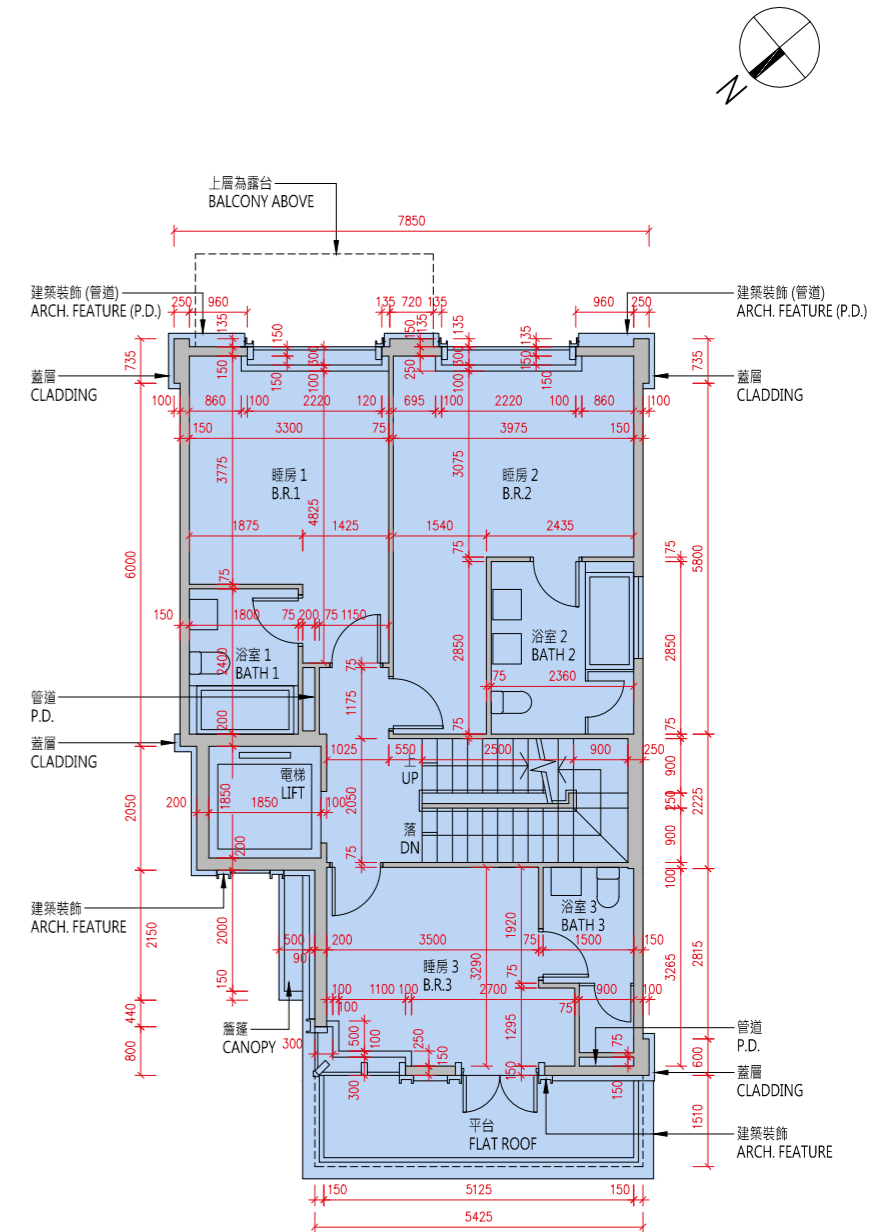

1樓平面圖
1/F Floor Plan

比例 : 0米/M 5米/M
Scale :

A6洋房
House A6

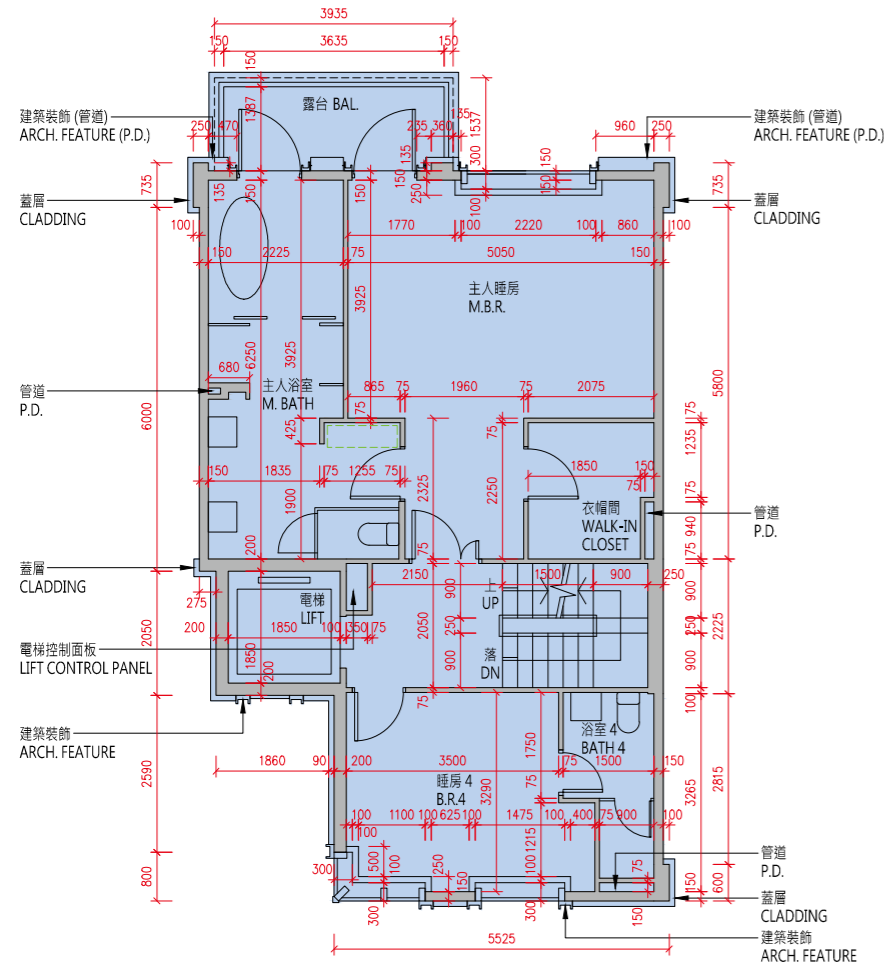
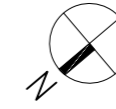

2樓平面圖
2/F Floor Plan

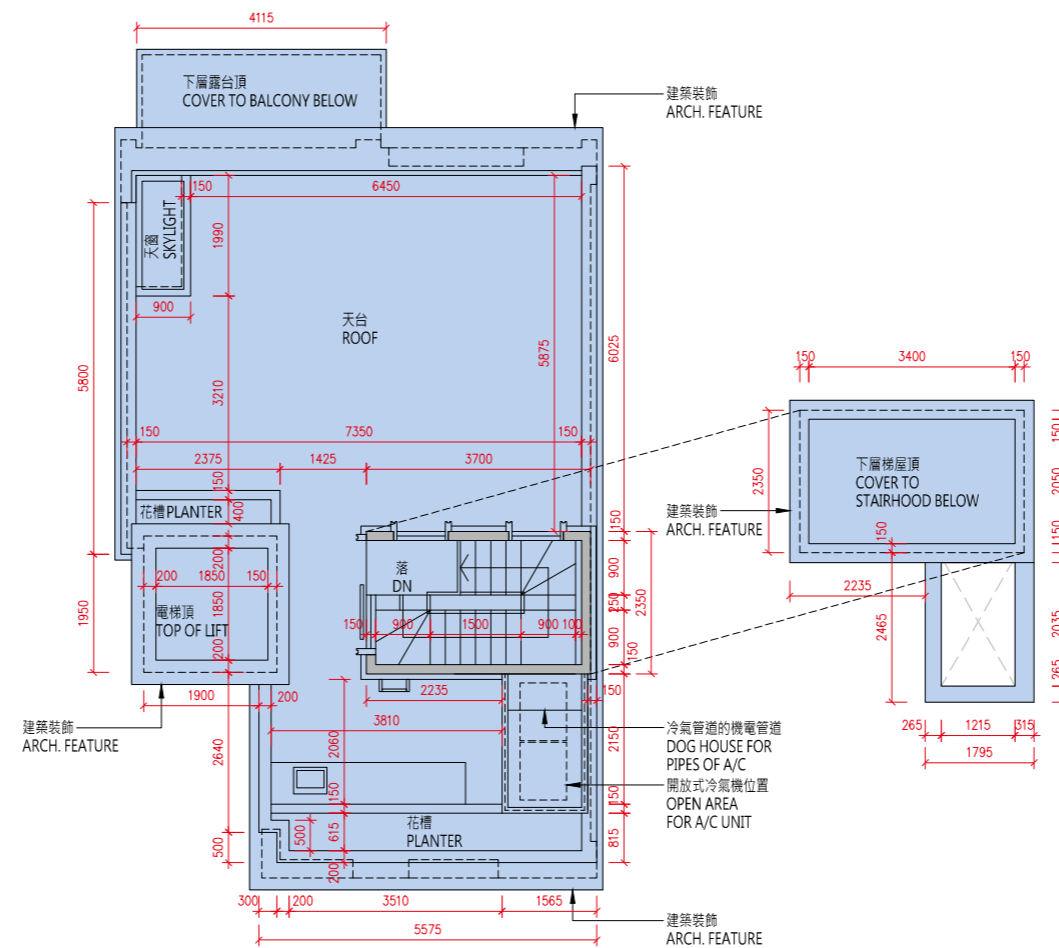

天台平面圖
Roof Floor Plan

比例：0米/M 5米/M
Scale :

樓層 Floor	地庫1樓 B1/F	地下 G/F	1樓 1/F	2樓 2/F	天台 Roof
層與層之間的高度 (毫米) Floor to Floor Height (mm)	4350	3750, 3970, 4000	3050, 3125, 3300	3500	N/A
樓板 (不包括灰泥) 的厚度 (毫米) Thickness of Floor Slab (excluding plaster) (mm)	200	150, 200	150, 200	150, 200	N/A

10 發展項目的住宅物業的樓面平面圖

FLOOR PLANS OF RESIDENTIAL PROPERTIES IN THE DEVELOPMENT

備註：

- (1) 批地文件特別條件第 8(d) 條規定：-
「(d) 在該地段已建成或擬建的住宅單位數目須不少於 515，並就本 (d) 分條而言：
 - (i) 一座擬作為單一家庭住宅的獨立屋、半獨立屋或排屋均被視為一個住宅單位；
 - (ii) 署長就獨立屋、半獨立屋或排屋是否構成或擬作為單一家庭住宅所作的決定將為最終決定，並對買方構成約束力；及
 - (iii) 署長就什麼構成一個住宅單位所作的決定將為最終決定，並對買方構成約束力。」
- (2) 公契及管理協議第 85 條規定：-
「管理人須在管理處備存一份由地政總署署長或任何其他不時替代其位的政府主管當局根據本公契附表三第 43 條所發出的同意的資料記錄，以供所有業主免費查閱及自費影印該資料記錄，並繳付合理費用。所有就此收取的費用一律撥入特別基金。」
- (3) 公契及管理協議附表三第 43 條規定：-
「43. 除非事先獲得地政總署署長或任何其他不時替代其位的政府主管當局的書面同意，否則任何業主不得進行或允許或容忍他人進行任何與住宅單位相關而可導致該住宅單位內部相連及通往任何毗連或毗鄰的住宅單位的工程，包括但不限於拆卸或更改任何分隔牆或任何樓板或天台樓板或任何間隔結構。而地政總署署長具有全權酌情給予同意或拒絕同意，倘若給予同意，業主須遵從地政總署署長按其全權酌情附加的任何條款及條件 (包括支付費用)。」
- (4) 發展項目內所提供的住宅單位總數目為 590。
- (5) 平面圖所列的數字為以毫米標示之建築結構尺寸。
- (6) 因住宅物業的較高樓層的結構牆的厚度遞減，較高樓層的內部面積，一般比較低樓層的內部面積稍大。
- (7) 請參閱本售樓說明書第 20 頁為住宅物業樓面平面圖而設之備註及名詞及簡稱的圖例。

Notes:

- (1) Special Condition No. (8)(d) of the Land Grant stipulates that: -
“(d) the total number of residential units erected or to be erected on the lot shall not be less than 515, and for the purposes of this sub-clause (d):
 - (i) a detached, semi-detached or terraced house which is intended for use as a single family residence shall be regarded as a residential unit;
 - (ii) the decision of the Director as to whether a detached, semi-detached or terraced house constitutes or is intended for use as a single family residence shall be final and binding on the Purchaser; and
 - (iii) the decision of the Director as to what constitutes a residential unit shall be final and binding on the Purchaser.”
- (2) Clause 85 of the Deed of Mutual Covenant incorporating Management Agreement stipulates that: -
“85. The Manager shall deposit in the management office the record provided by the Director of Lands or any other Government authority in place of him from time to time of the information relating to the consent given under Clause 43 of the Third Schedule hereto for inspection by all Owners free of charge and taking copies at their own expense and on payment of a reasonable charge. All charges received shall be credited to the Special Fund.”
- (3) Clause 43 of the Third Schedule to the Deed of Mutual Covenant incorporating Management Agreement stipulates that: -
“43. No Owner shall carry out or permit or suffer to be carried out any works in connection with any Residential Unit, including but not limited to demolition or alteration of any partition wall or any floor or roof slab or any partition structure, which will result in such Residential Unit being internally linked to and accessible from any adjoining or adjacent Residential Unit, except with the prior written consent of the Director of Lands or any other Government authority in place of him from time to time, which consent may be given or withheld at his absolute discretion and if given, may be subject to such terms and conditions (including payment of fees) as may be imposed by him at his absolute discretion.”
- (4) The total number of residential units provided in the development is 590.
- (5) The dimensions in floor plans are all structural dimensions in millimeter.
- (6) The internal areas of the residential properties on the upper floors will generally be slightly larger than those on the lower floors because of the reducing thickness of the structural walls on the upper floors.
- (7) Please refer to page 20 of this sales brochure for the remarks and legends of the terms and abbreviations for the floor plans of residential properties.

A7洋房
House A7

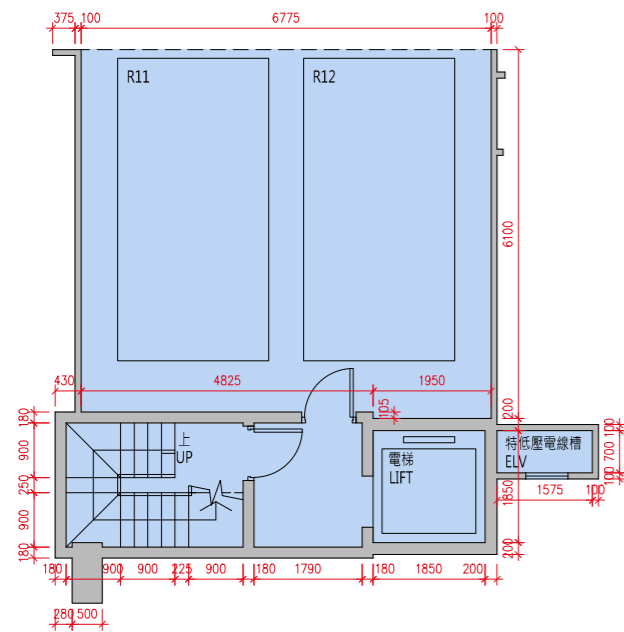

地庫1樓平面圖
B1/F Floor Plan

貼鄰住客停車位的面積 (不計算入停車位面積或實用面積) :
A7 洋房地庫 1 樓為 15.821 平方米 (170 平方呎)。
Area adjoining residential parking space (not included in the area of parking space or saleable area): House A7 on B1/F is 15.821sq.m. (170sq.ft.)

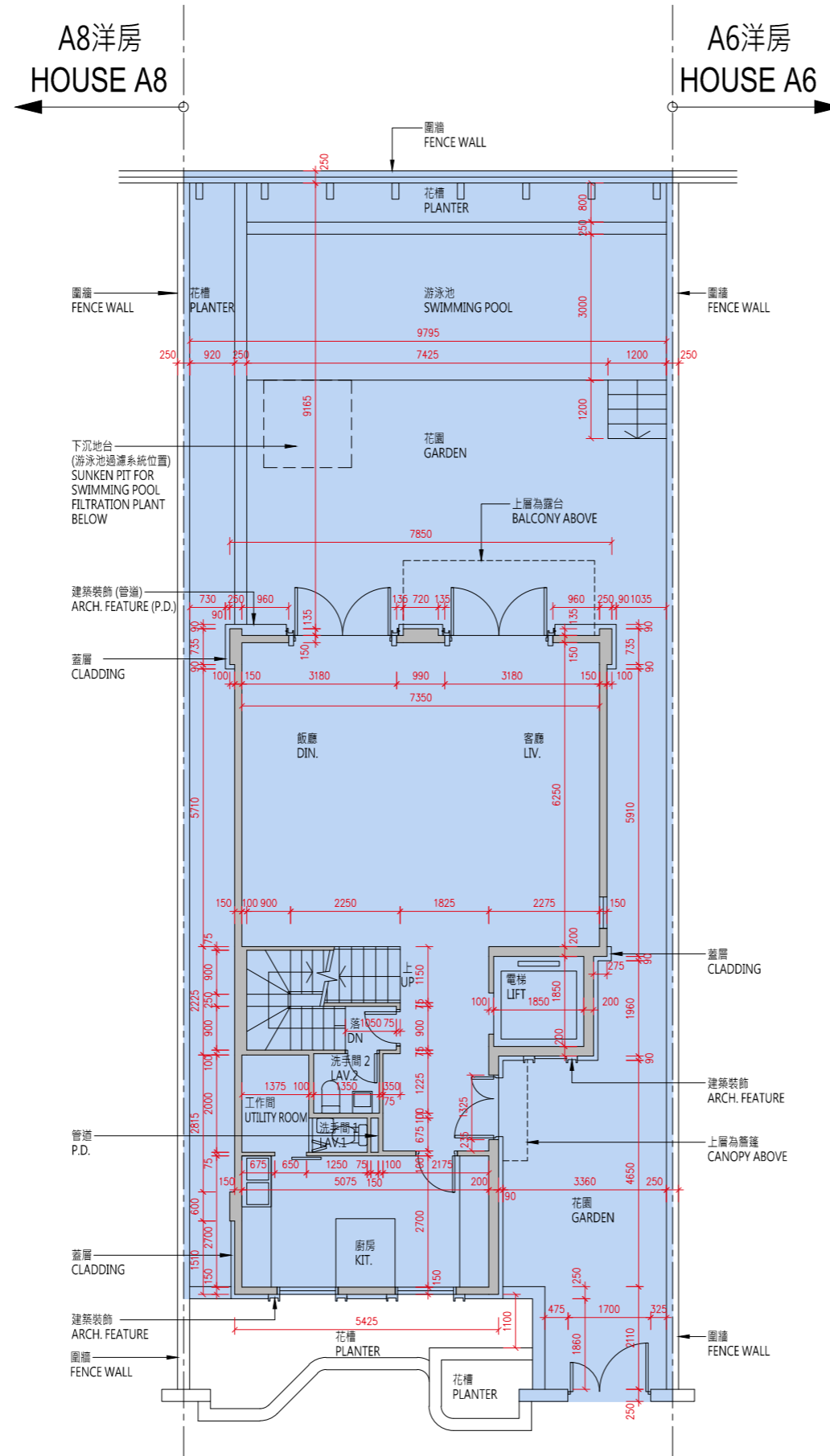

地下平面圖
G/F Floor Plan

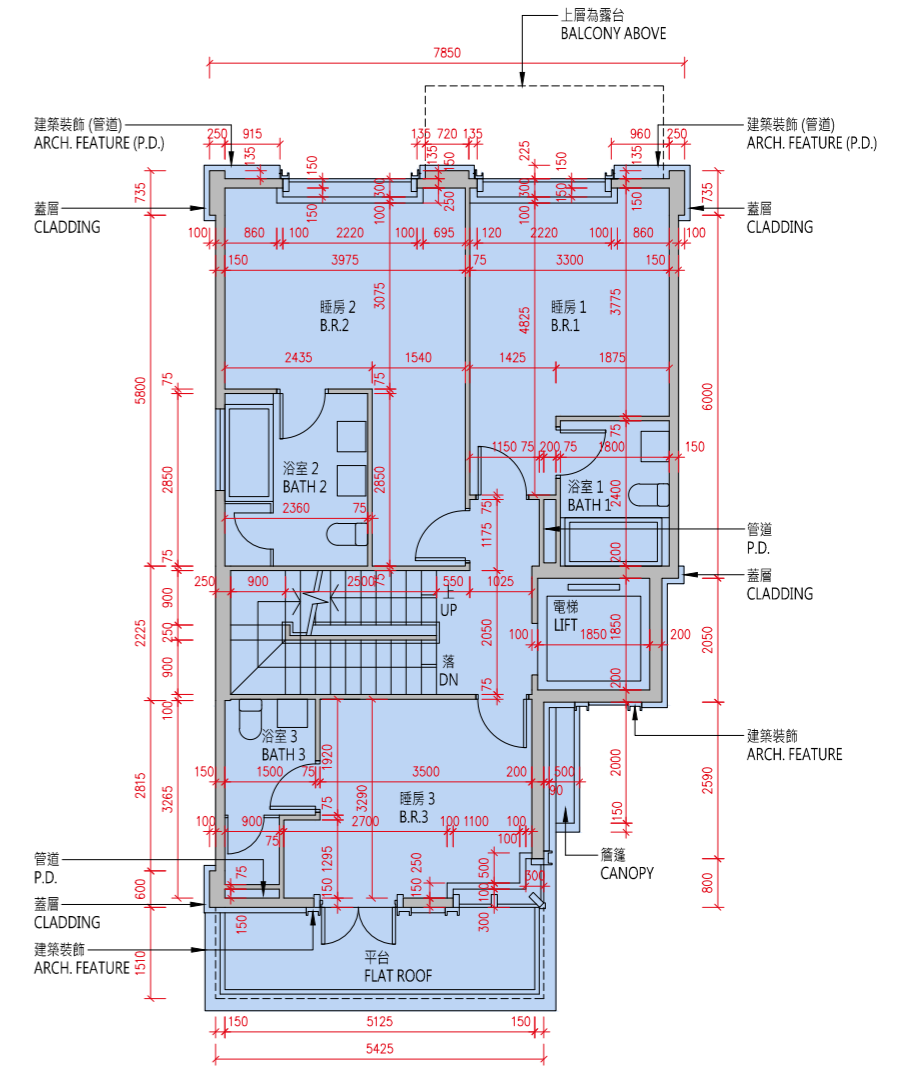

1樓平面圖
1/F Floor Plan

比例 : 0米/M 5米/M
Scale :

A7洋房
House A7

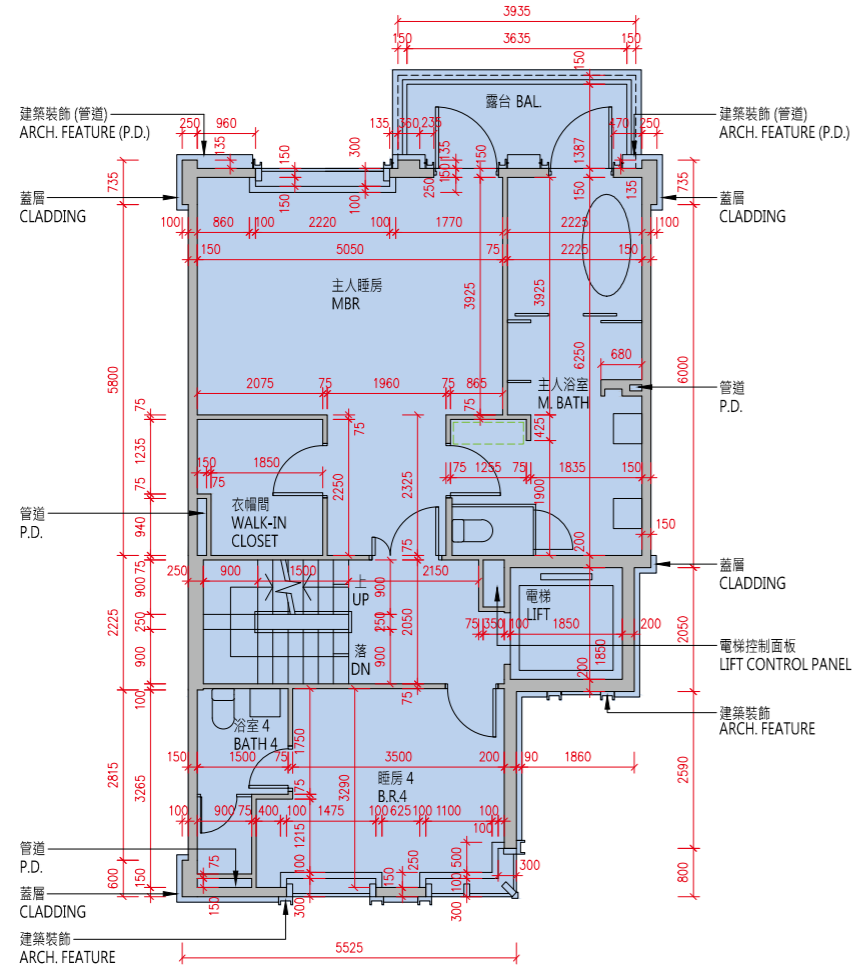
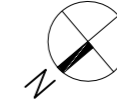

2樓平面圖
2/F Floor Plan

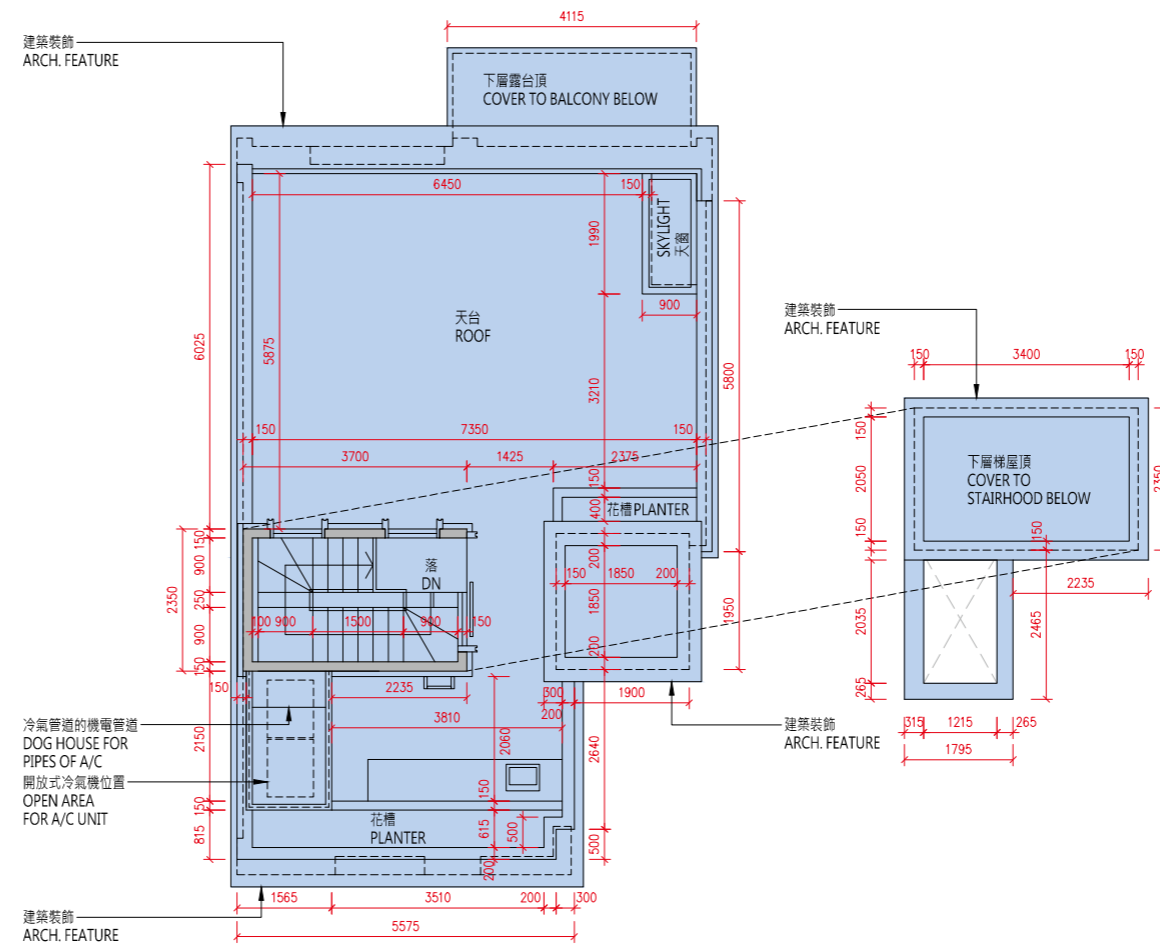

天台平面圖
Roof Floor Plan

比例：0米/M 5米/M
Scale :

樓層 Floor	地庫1樓 B1/F	地下 G/F	1樓 1/F	2樓 2/F	天台 Roof
層與層之間的高度 (毫米) Floor to Floor Height (mm)	4350	3750, 3970, 4000	3050, 3125, 3300	3500	N/A
樓板 (不包括灰泥) 的厚度 (毫米) Thickness of Floor Slab (excluding plaster) (mm)	200	150, 200	150, 200	150, 200	N/A

備註：

(1) 批地文件特別條件第 8(d) 條規定：-

「(d) 在該地段已建成或擬建的住宅單位數目須不少於 515，並就本 (d) 分條而言：

- (i) 一座擬作為單一家庭住宅的獨立屋、半獨立屋或排屋均被視為一個住宅單位；
- (ii) 署長就獨立屋、半獨立屋或排屋是否構成或擬作為單一家庭住宅所作的決定將為最終決定，並對買方構成約束力；及
- (iii) 署長就什麼構成一個住宅單位所作的決定將為最終決定，並對買方構成約束力。」

(2) 公契及管理協議第 85 條規定：-

「管理人須在管理處備存一份由地政總署署長或任何其他不時替代其位的政府主管當局根據本公契附表三第 43 條所發出的同意的資料記錄，以供所有業主免費查閱及自費影印該資料記錄，並繳付合理費用。所有就此收取的費用一律撥入特別基金。」

(3) 公契及管理協議附表三第 43 條規定：-

「43. 除非事先獲得地政總署署長或任何其他不時替代其位的政府主管當局的書面同意，否則任何業主不得進行或允許或容忍他人進行任何與住宅單位相關而可導致該住宅單位內部相連及通往任何毗連或毗鄰的住宅單位的工程，包括但不限於拆卸或更改任何分隔牆或任何樓板或天台樓板或任何間隔結構。而地政總署署長具有全權酌情給予同意或拒絕同意，倘若給予同意，業主須遵從地政總署署長按其全權酌情附加的任何條款及條件（包括支付費用）。」

(4) 發展項目內所提供的住宅單位總數目為 590。

(5) 平面圖所列的數字為以毫米標示之建築結構尺寸。

(6) 因住宅物業的較高樓層的結構牆的厚度遞減，較高樓層的內部面積，一般比較低樓層的內部面積稍大。

(7) 請參閱本售樓說明書第 20 頁為住宅物業樓面平面圖而設之備註及名詞及簡稱的圖例。

Notes:

(1) Special Condition No. (8)(d) of the Land Grant stipulates that: -

“(d) the total number of residential units erected or to be erected on the lot shall not be less than 515, and for the purposes of this sub-clause (d):

- (i) a detached, semi-detached or terraced house which is intended for use as a single family residence shall be regarded as a residential unit;
- (ii) the decision of the Director as to whether a detached, semi-detached or terraced house constitutes or is intended for use as a single family residence shall be final and binding on the Purchaser; and
- (iii) the decision of the Director as to what constitutes a residential unit shall be final and binding on the Purchaser.”

(2) Clause 85 of the Deed of Mutual Covenant incorporating Management Agreement stipulates that: -

“85. The Manager shall deposit in the management office the record provided by the Director of Lands or any other Government authority in place of him from time to time of the information relating to the consent given under Clause 43 of the Third Schedule hereto for inspection by all Owners free of charge and taking copies at their own expense and on payment of a reasonable charge. All charges received shall be credited to the Special Fund.”

(3) Clause 43 of the Third Schedule to the Deed of Mutual Covenant incorporating Management Agreement stipulates that: -

“43. No Owner shall carry out or permit or suffer to be carried out any works in connection with any Residential Unit, including but not limited to demolition or alteration of any partition wall or any floor or roof slab or any partition structure, which will result in such Residential Unit being internally linked to and accessible from any adjoining or adjacent Residential Unit, except with the prior written consent of the Director of Lands or any other Government authority in place of him from time to time, which consent may be given or withheld at his absolute discretion and if given, may be subject to such terms and conditions (including payment of fees) as may be imposed by him at his absolute discretion.”

(4) The total number of residential units provided in the development is 590.

(5) The dimensions in floor plans are all structural dimensions in millimeter.

(6) The internal areas of the residential properties on the upper floors will generally be slightly larger than those on the lower floors because of the reducing thickness of the structural walls on the upper floors.

(7) Please refer to page 20 of this sales brochure for the remarks and legends of the terms and abbreviations for the floor plans of residential properties.

A8洋房
House A8

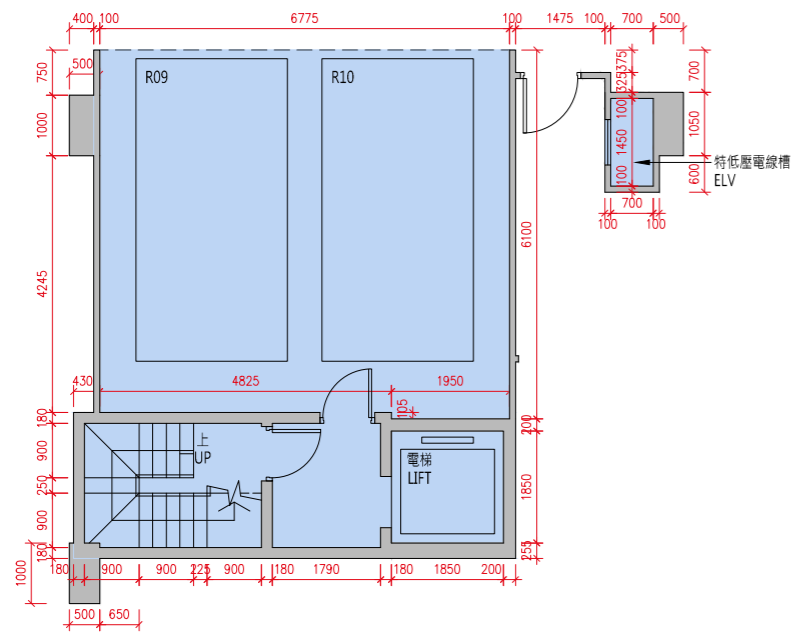

地庫1樓平面圖
B1/F Floor Plan

貼鄰住客停車位的面積 (不計算入停車位面積或實用面積) :
A8 洋房地庫 1 樓為 15.821 平方米 (170 平方呎)。
Area adjoining residential parking space (not included in the area of parking space or saleable area): House A8 on B1/F is 15.821 sq.m. (170sq.ft.)

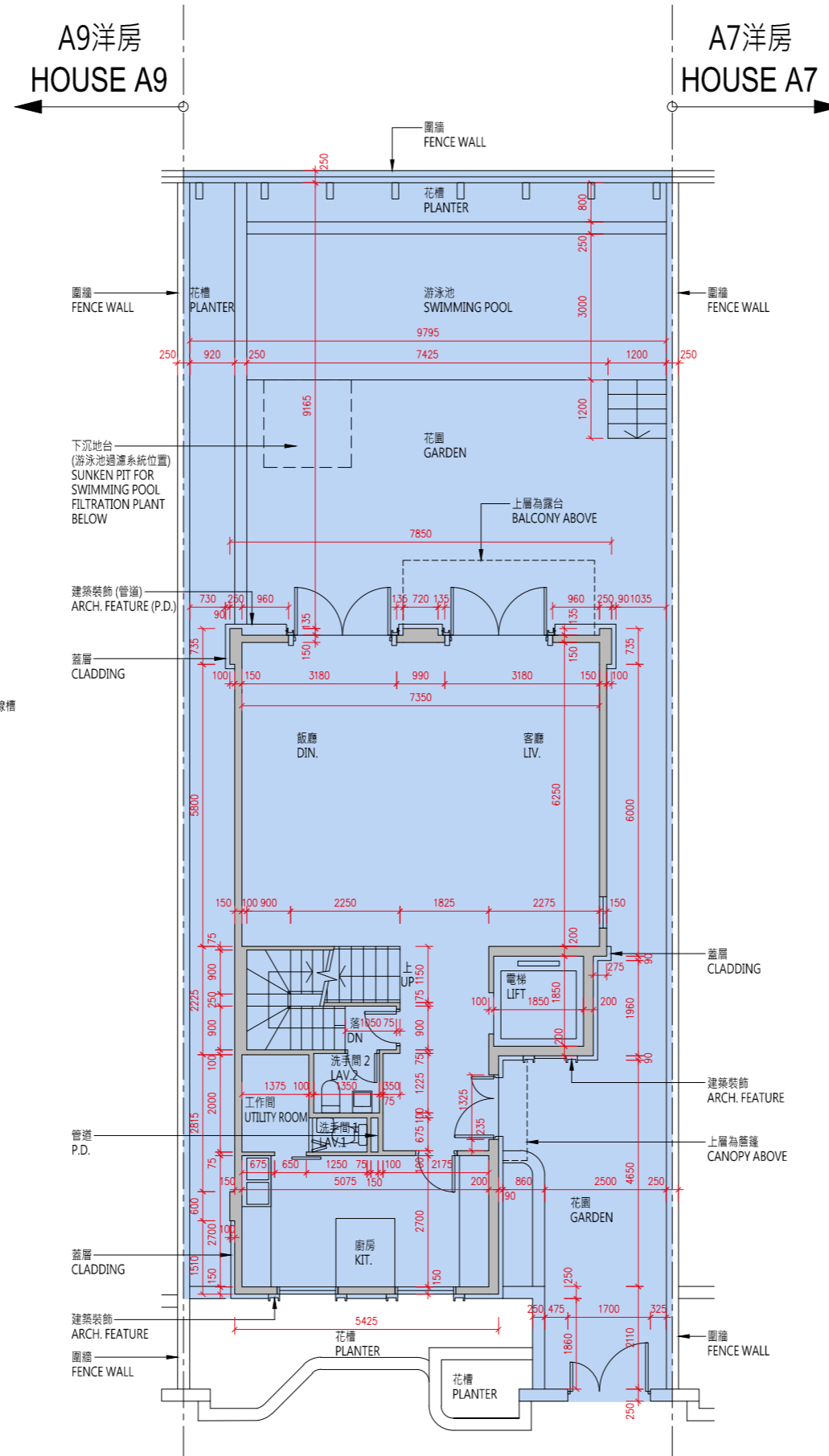

地下平面圖
G/F Floor Plan

A7洋房
HOUSE A7

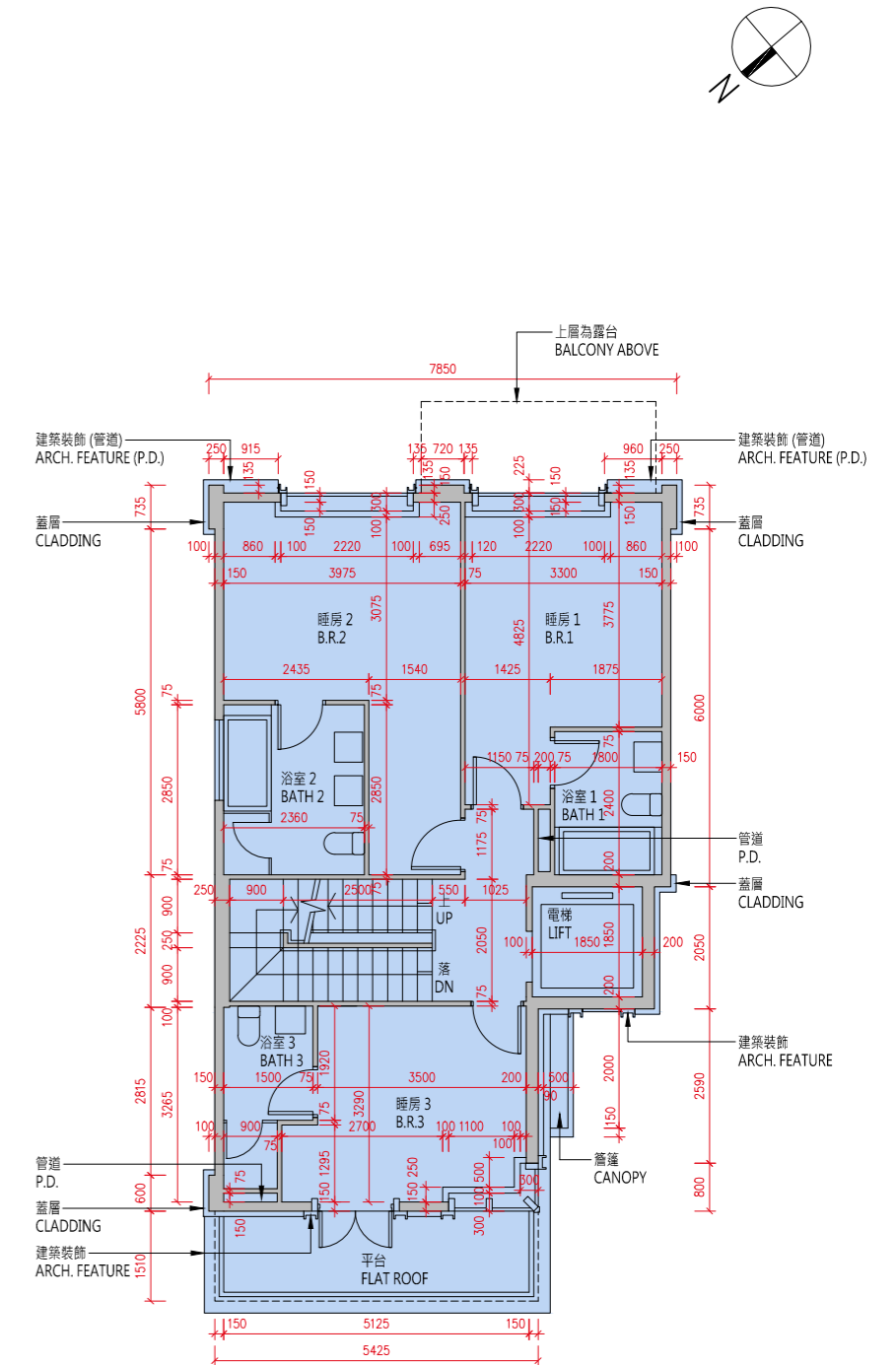

1樓平面圖
1/F Floor Plan

比例 : 0米/M 5米/M
Scale :

A8洋房
House A8

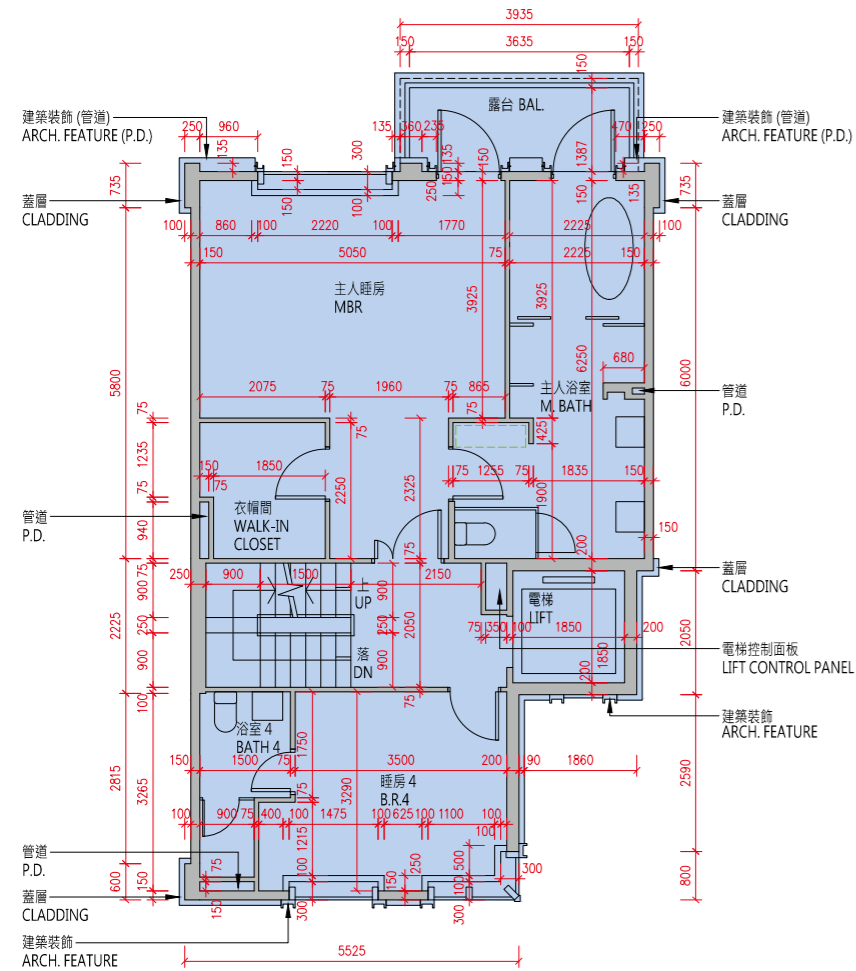
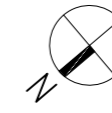

2樓平面圖
2/F Floor Plan

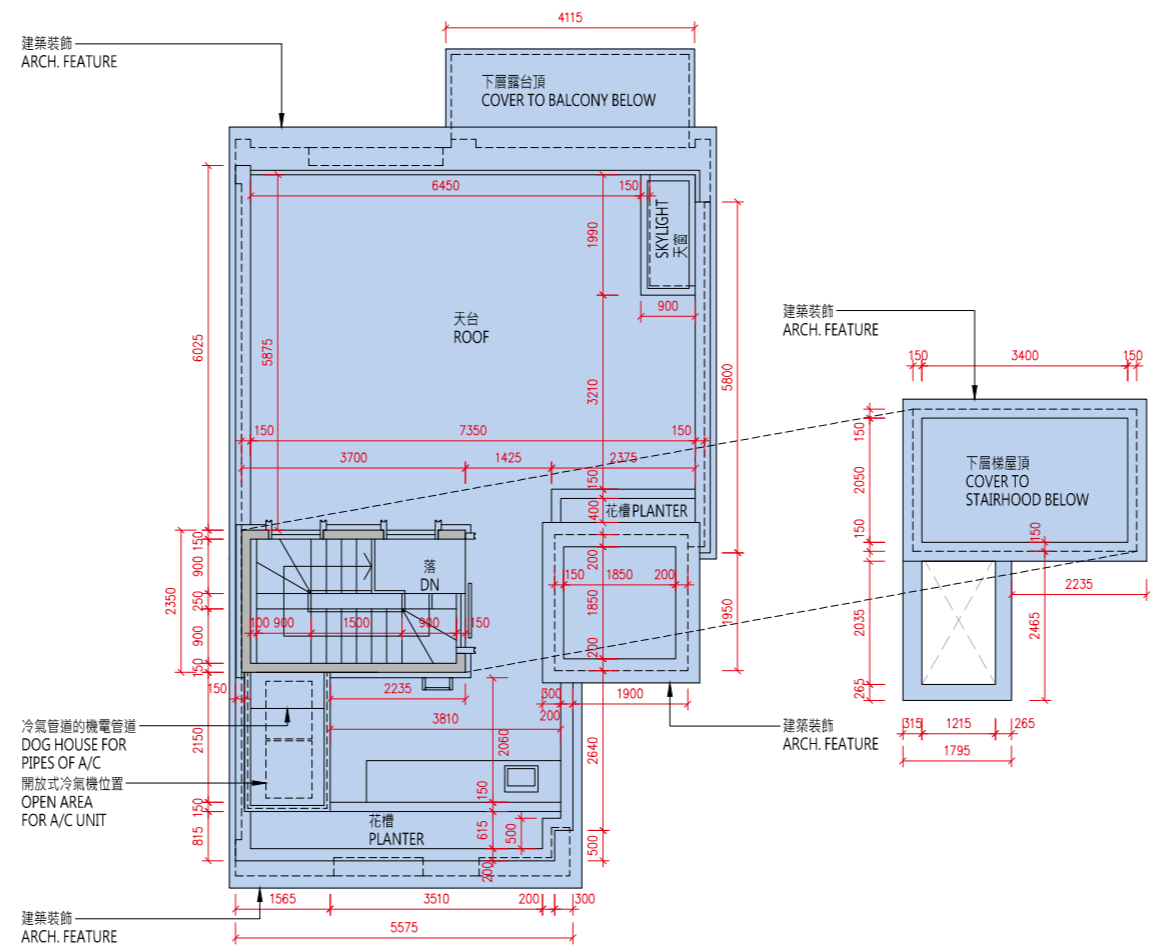

天台平面圖
Roof Floor Plan

比例：0米/M 5米/M
Scale:

樓層 Floor	地庫1樓 B1/F	地下 G/F	1樓 1/F	2樓 2/F	天台 Roof
層與層之間的高度 (毫米) Floor to Floor Height (mm)	4350	3750, 3970, 4000	3050, 3125, 3300	3500	N/A
樓板 (不包括灰泥) 的厚度 (毫米) Thickness of Floor Slab (excluding plaster) (mm)	200	150, 200	150, 200	150, 200	N/A

10 發展項目的住宅物業的樓面平面圖

FLOOR PLANS OF RESIDENTIAL PROPERTIES IN THE DEVELOPMENT

備註：

- (1) 批地文件特別條件第 8(d) 條規定：-
「(d) 在該地段已建成或擬建的住宅單位數目須不少於 515，並就本 (d) 分條而言：
 - (i) 一座擬作為單一家庭住宅的獨立屋、半獨立屋或排屋均被視為一個住宅單位；
 - (ii) 署長就獨立屋、半獨立屋或排屋是否構成或擬作為單一家庭住宅所作的決定將為最終決定，並對買方構成約束力；及
 - (iii) 署長就什麼構成一個住宅單位所作的決定將為最終決定，並對買方構成約束力。」
- (2) 公契及管理協議第 85 條規定：-
「管理人須在管理處備存一份由地政總署署長或任何其他不時替代其位的政府主管當局根據本公契附表三第 43 條所發出的同意的資料記錄，以供所有業主免費查閱及自費影印該資料記錄，並繳付合理費用。所有就此收取的費用一律撥入特別基金。」
- (3) 公契及管理協議附表三第 43 條規定：-
「43. 除非事先獲得地政總署署長或任何其他不時替代其位的政府主管當局的書面同意，否則任何業主不得進行或允許或容忍他人進行任何與住宅單位相關而可導致該住宅單位內部相連及通往任何毗連或毗鄰的住宅單位的工程，包括但不限於拆卸或更改任何分隔牆或任何樓板或天台樓板或任何間隔結構。而地政總署署長具有全權酌情給予同意或拒絕同意，倘若給予同意，業主須遵從地政總署署長按其全權酌情附加的任何條款及條件 (包括支付費用)。」
- (4) 發展項目內所提供的住宅單位總數目為 590。
- (5) 平面圖所列的數字為以毫米標示之建築結構尺寸。
- (6) 因住宅物業的較高樓層的結構牆的厚度遞減，較高樓層的內部面積，一般比較低樓層的內部面積稍大。
- (7) 請參閱本售樓說明書第 20 頁為住宅物業樓面平面圖而設之備註及名詞及簡稱的圖例。

Notes:

- (1) Special Condition No. (8)(d) of the Land Grant stipulates that: -
“(d) the total number of residential units erected or to be erected on the lot shall not be less than 515, and for the purposes of this sub-clause (d):
 - (i) a detached, semi-detached or terraced house which is intended for use as a single family residence shall be regarded as a residential unit;
 - (ii) the decision of the Director as to whether a detached, semi-detached or terraced house constitutes or is intended for use as a single family residence shall be final and binding on the Purchaser; and
 - (iii) the decision of the Director as to what constitutes a residential unit shall be final and binding on the Purchaser.”
- (2) Clause 85 of the Deed of Mutual Covenant incorporating Management Agreement stipulates that: -
“85. The Manager shall deposit in the management office the record provided by the Director of Lands or any other Government authority in place of him from time to time of the information relating to the consent given under Clause 43 of the Third Schedule hereto for inspection by all Owners free of charge and taking copies at their own expense and on payment of a reasonable charge. All charges received shall be credited to the Special Fund.”
- (3) Clause 43 of the Third Schedule to the Deed of Mutual Covenant incorporating Management Agreement stipulates that: -
“43. No Owner shall carry out or permit or suffer to be carried out any works in connection with any Residential Unit, including but not limited to demolition or alteration of any partition wall or any floor or roof slab or any partition structure, which will result in such Residential Unit being internally linked to and accessible from any adjoining or adjacent Residential Unit, except with the prior written consent of the Director of Lands or any other Government authority in place of him from time to time, which consent may be given or withheld at his absolute discretion and if given, may be subject to such terms and conditions (including payment of fees) as may be imposed by him at his absolute discretion.”
- (4) The total number of residential units provided in the development is 590.
- (5) The dimensions in floor plans are all structural dimensions in millimeter.
- (6) The internal areas of the residential properties on the upper floors will generally be slightly larger than those on the lower floors because of the reducing thickness of the structural walls on the upper floors.
- (7) Please refer to page 20 of this sales brochure for the remarks and legends of the terms and abbreviations for the floor plans of residential properties.

A9洋房
House A9

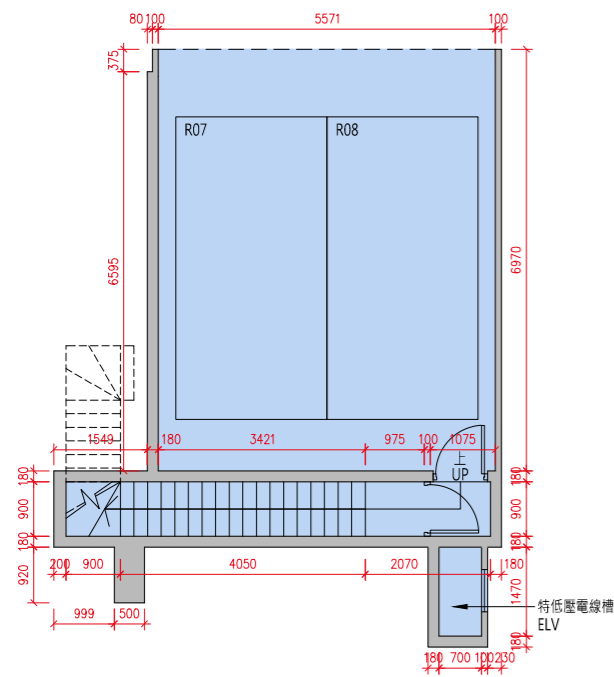

地庫1樓平面圖
B1/F Floor Plan

貼鄰住客停車位的面積 (不計算入停車位面積或實用面積) :
A9 洋房地庫 1 樓為 13.830 平方米 (149 平方呎)。
Area adjoining residential parking space (not included in the area of parking space or saleable area): House A9 on B1/F is 13.830 sq.m. (149sq.ft.)

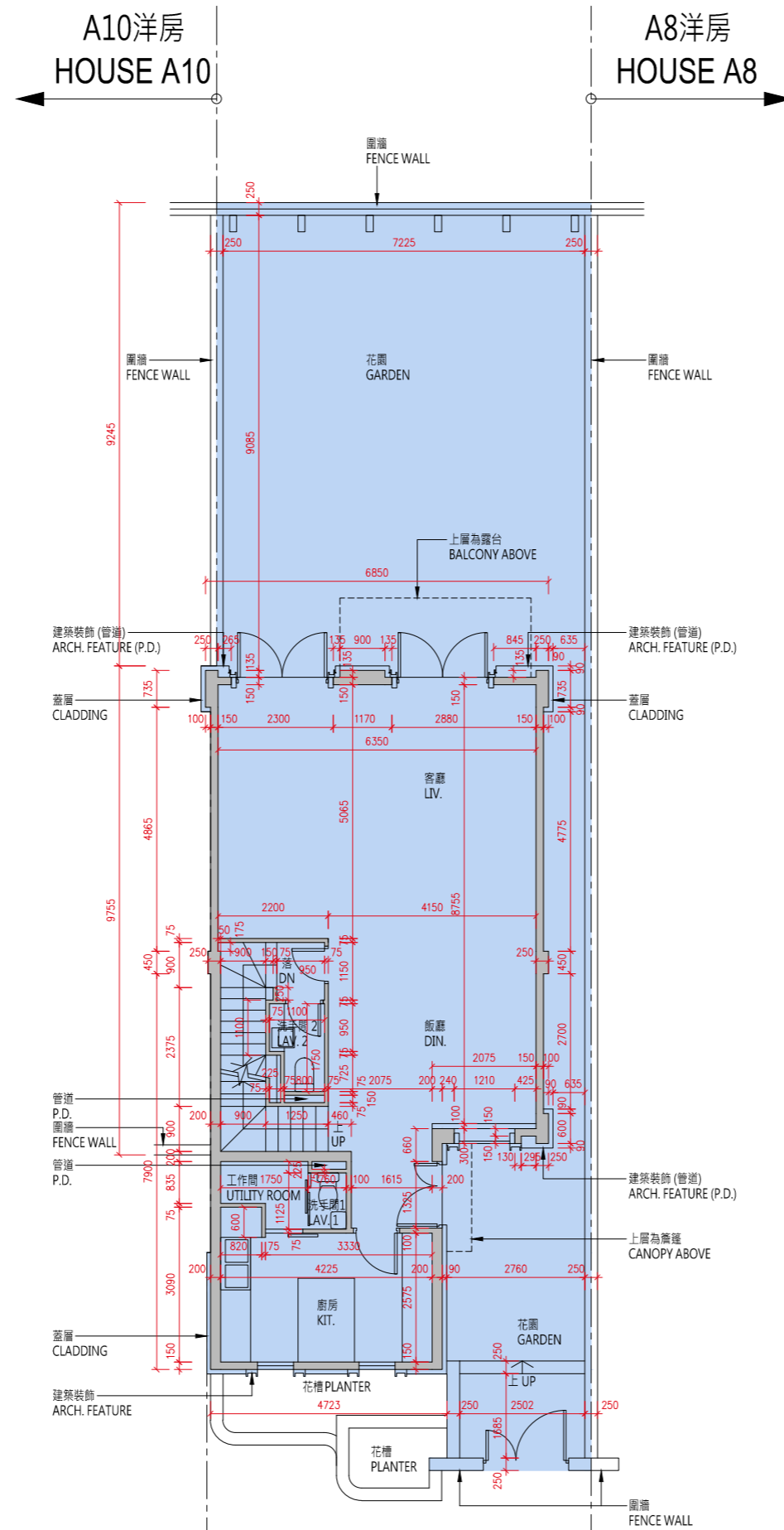

地下平面圖
G/F Floor Plan

A8洋房
HOUSE A8

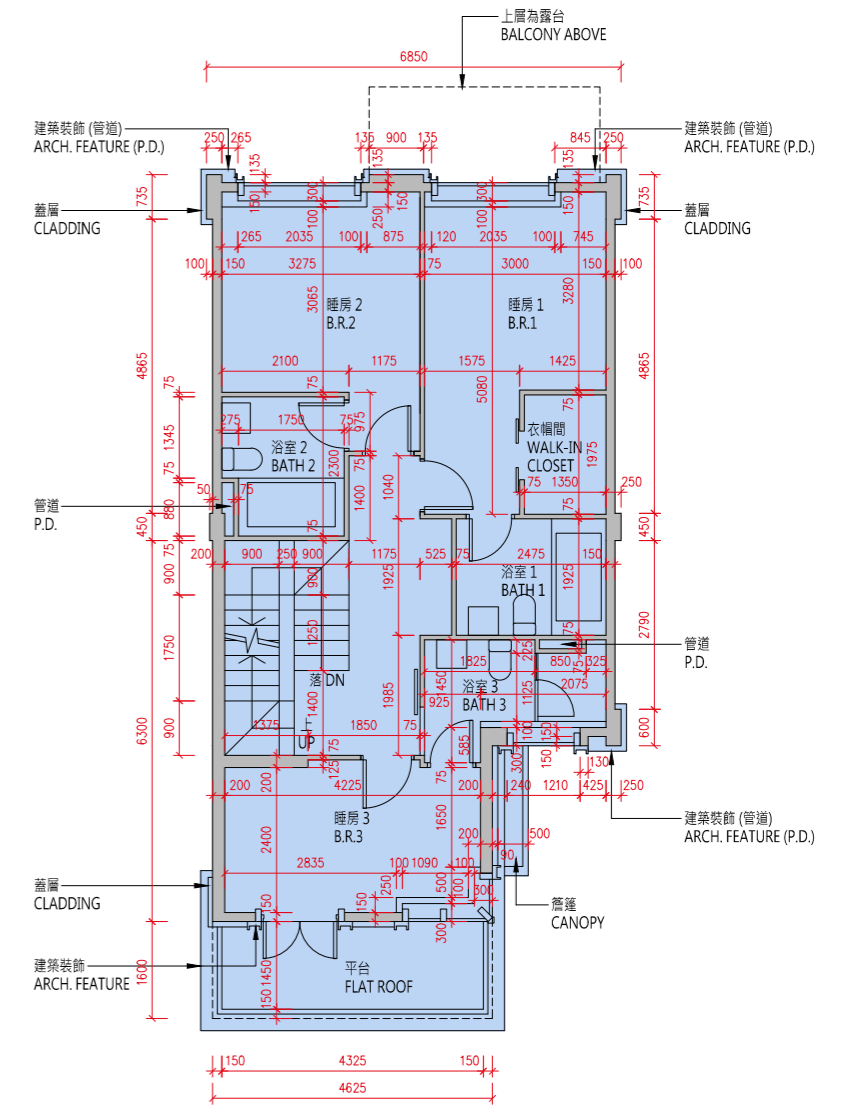

1樓平面圖
1/F Floor Plan

比例 : 0米/M 5米/M
Scale : 5米/M

10 發展項目的住宅物業的樓面平面圖 FLOOR PLANS OF RESIDENTIAL PROPERTIES IN THE DEVELOPMENT

A9洋房 House A9

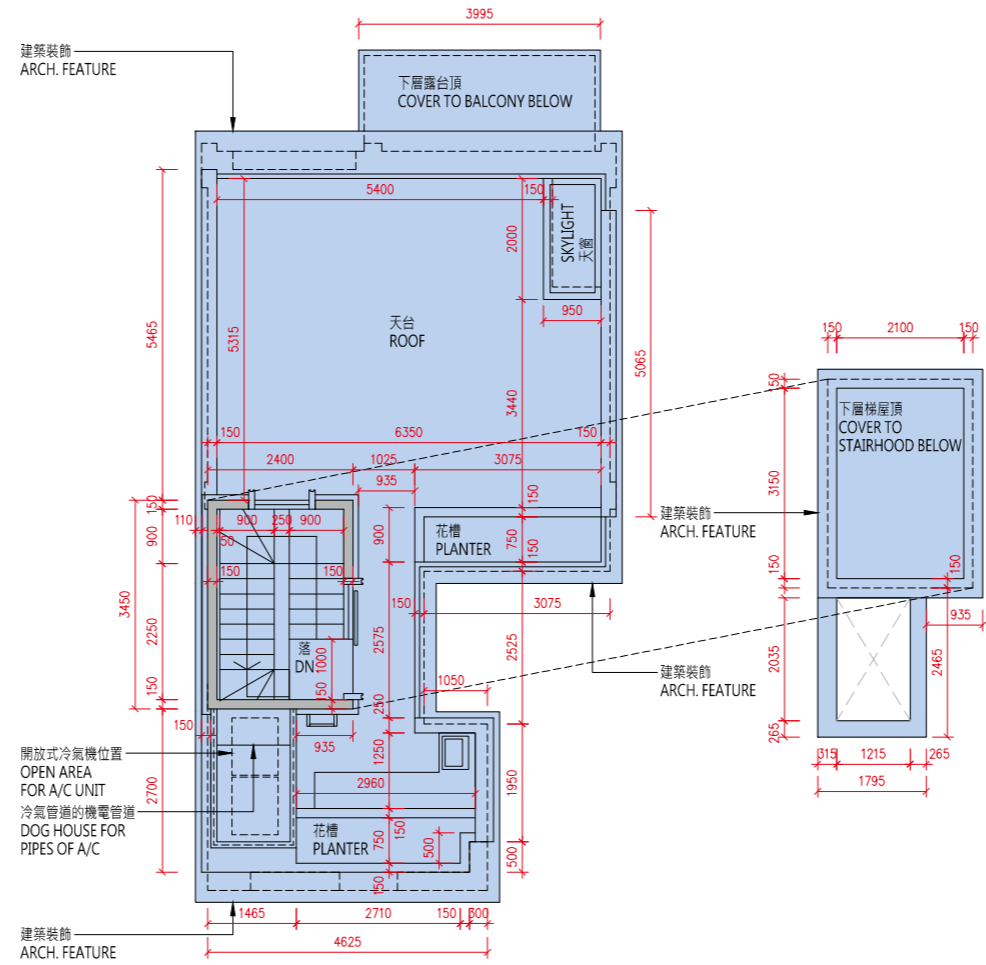
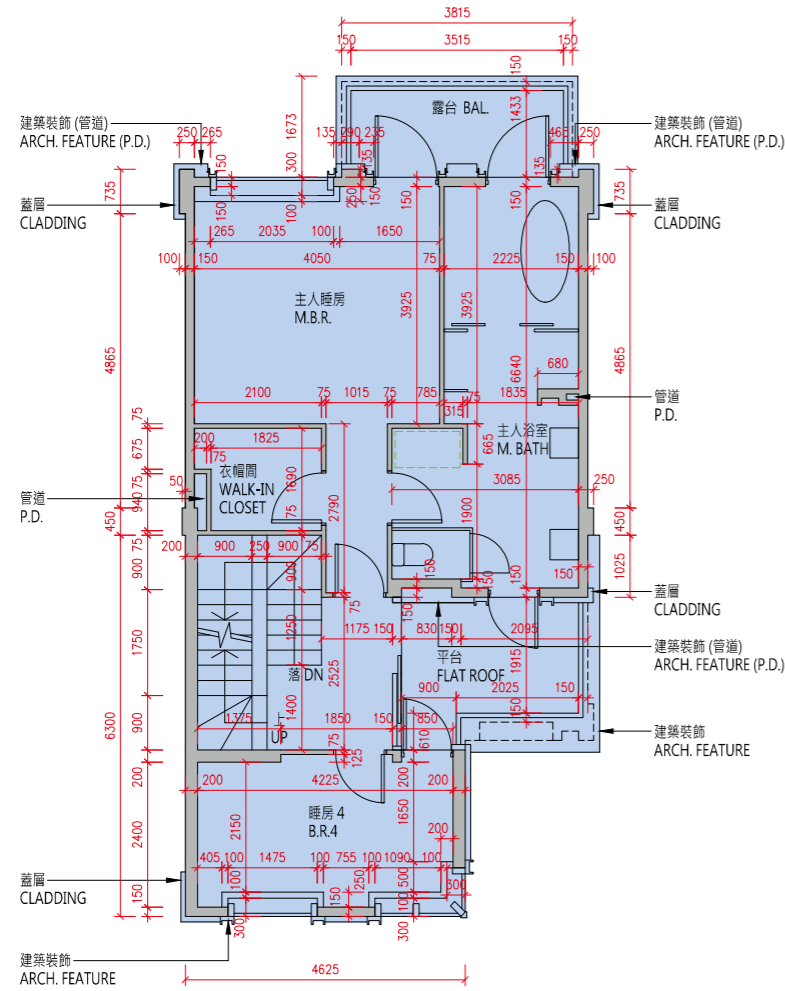
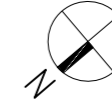

比例：0米/M 5米/M
Scale :

樓層 Floor	地庫1樓 B1/F	地下 G/F	1樓 1/F	2樓 2/F	天台 Roof
層與層之間的高度 (毫米) Floor to Floor Height (mm)	5060, 5280, 5430, 6030	3750, 3970, 4000	3050, 3080, 3125, 3300	3500	N/A
樓板 (不包括灰泥) 的厚度 (毫米) Thickness of Floor Slab (excluding plaster) (mm)	200	150, 200	150, 200	150, 200	N/A

備註：

(1) 批地文件特別條件第 8(d) 條規定：-

「(d) 在該地段已建成或擬建的住宅單位數目須不少於 515，並就本 (d) 分條而言：

- (i) 一座擬作為單一家庭住宅的獨立屋、半獨立屋或排屋均被視為一個住宅單位；
- (ii) 署長就獨立屋、半獨立屋或排屋是否構成或擬作為單一家庭住宅所作的決定將為最終決定，並對買方構成約束力；及
- (iii) 署長就什麼構成一個住宅單位所作的決定將為最終決定，並對買方構成約束力。」

(2) 公契及管理協議第 85 條規定：-

「管理人須在管理處備存一份由地政總署署長或任何其他不時替代其位的政府主管當局根據本公契附表三第 43 條所發出的同意的資料記錄，以供所有業主免費查閱及自費影印該資料記錄，並繳付合理費用。所有就此收取的費用一律撥入特別基金。」

(3) 公契及管理協議附表三第 43 條規定：-

「43. 除非事先獲得地政總署署長或任何其他不時替代其位的政府主管當局的書面同意，否則任何業主不得進行或允許或容忍他人進行任何與住宅單位相關而可導致該住宅單位內部相連及通往任何毗連或毗鄰的住宅單位的工程，包括但不限於拆卸或更改任何分隔牆或任何樓板或天台樓板或任何間隔結構。而地政總署署長具有全權酌情給予同意或拒絕同意，倘若給予同意，業主須遵從地政總署署長按其全權酌情附加的任何條款及條件（包括支付費用）。」

(4) 發展項目內所提供的住宅單位總數目為 590。

(5) 平面圖所列的數字為以毫米標示之建築結構尺寸。

(6) 因住宅物業的較高樓層的結構牆的厚度遞減，較高樓層的內部面積，一般比較低樓層的內部面積稍大。

(7) 請參閱本售樓說明書第 20 頁為住宅物業樓面平面圖而設之備註及名詞及簡稱的圖例。

Notes:

(1) Special Condition No. (8)(d) of the Land Grant stipulates that: -

“(d) the total number of residential units erected or to be erected on the lot shall not be less than 515, and for the purposes of this sub-clause (d):

- (i) a detached, semi-detached or terraced house which is intended for use as a single family residence shall be regarded as a residential unit;
- (ii) the decision of the Director as to whether a detached, semi-detached or terraced house constitutes or is intended for use as a single family residence shall be final and binding on the Purchaser; and
- (iii) the decision of the Director as to what constitutes a residential unit shall be final and binding on the Purchaser.”

(2) Clause 85 of the Deed of Mutual Covenant incorporating Management Agreement stipulates that: -

“85. The Manager shall deposit in the management office the record provided by the Director of Lands or any other Government authority in place of him from time to time of the information relating to the consent given under Clause 43 of the Third Schedule hereto for inspection by all Owners free of charge and taking copies at their own expense and on payment of a reasonable charge. All charges received shall be credited to the Special Fund.”

(3) Clause 43 of the Third Schedule to the Deed of Mutual Covenant incorporating Management Agreement stipulates that: -

“43. No Owner shall carry out or permit or suffer to be carried out any works in connection with any Residential Unit, including but not limited to demolition or alteration of any partition wall or any floor or roof slab or any partition structure, which will result in such Residential Unit being internally linked to and accessible from any adjoining or adjacent Residential Unit, except with the prior written consent of the Director of Lands or any other Government authority in place of him from time to time, which consent may be given or withheld at his absolute discretion and if given, may be subject to such terms and conditions (including payment of fees) as may be imposed by him at his absolute discretion.”

(4) The total number of residential units provided in the development is 590.

(5) The dimensions in floor plans are all structural dimensions in millimeter.

(6) The internal areas of the residential properties on the upper floors will generally be slightly larger than those on the lower floors because of the reducing thickness of the structural walls on the upper floors.

(7) Please refer to page 20 of this sales brochure for the remarks and legends of the terms and abbreviations for the floor plans of residential properties.

10 發展項目的住宅物業的樓面平面圖 FLOOR PLANS OF RESIDENTIAL PROPERTIES IN THE DEVELOPMENT

A10洋房 House A10

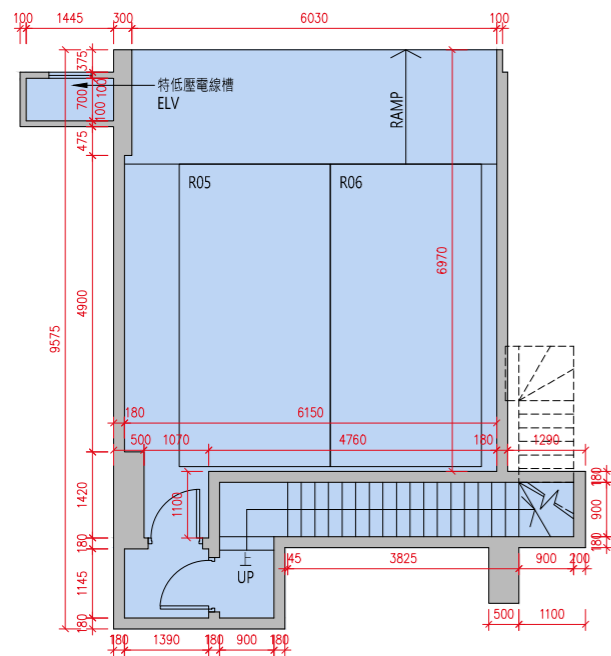

地庫1樓平面圖
B1/F Floor Plan

貼鄰住客停車位的面積 (不計算入停車位面積或實用面積) :
A10 洋房地庫 1 樓為 18.730 平方米 (202 平方呎)。
Area adjoining residential parking space (not included in the area of parking space or saleable area): House A10 on B1/F is 18.730 sq.m. (202sq.ft.)

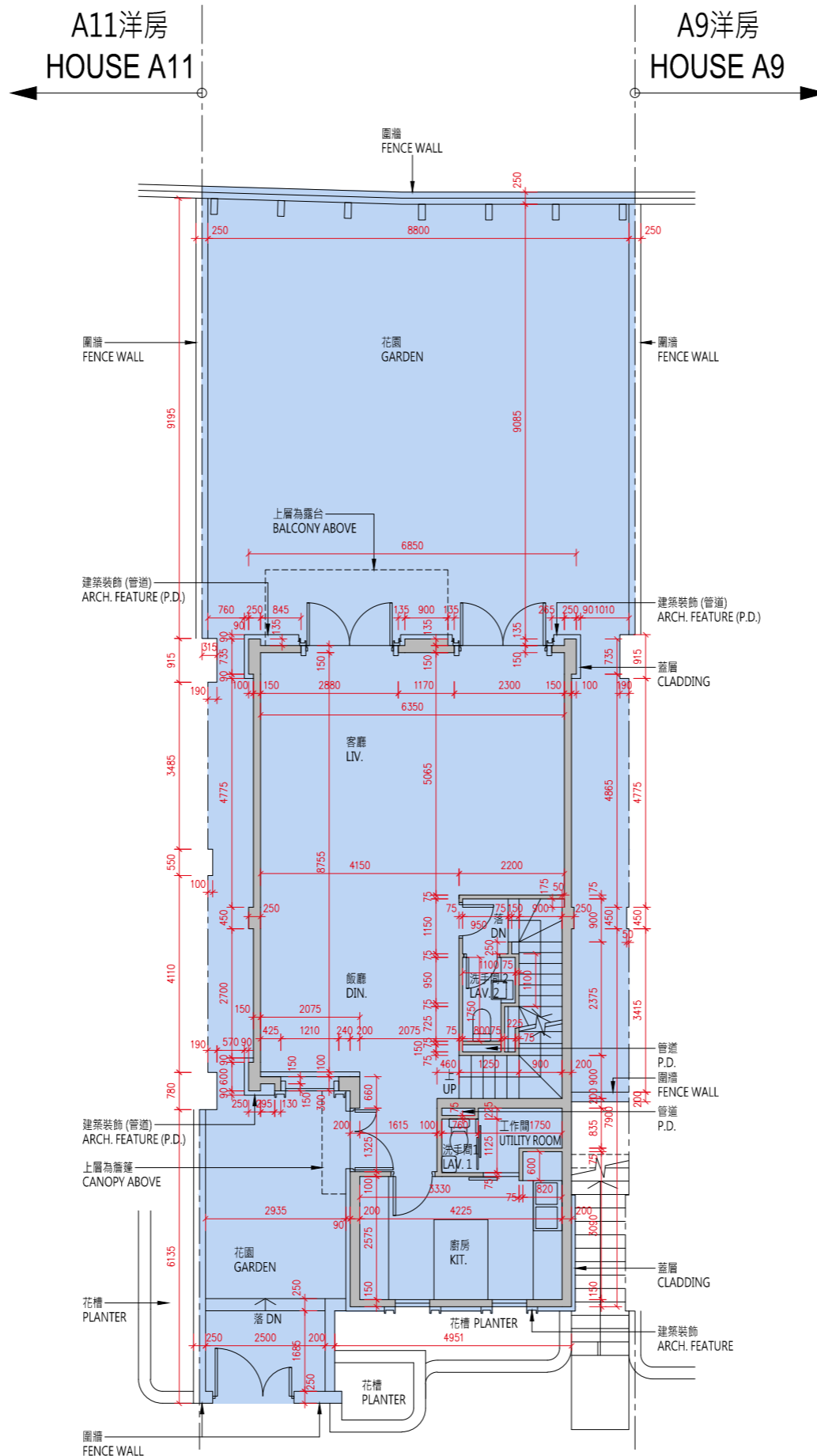

地下平面圖
G/F Floor Plan

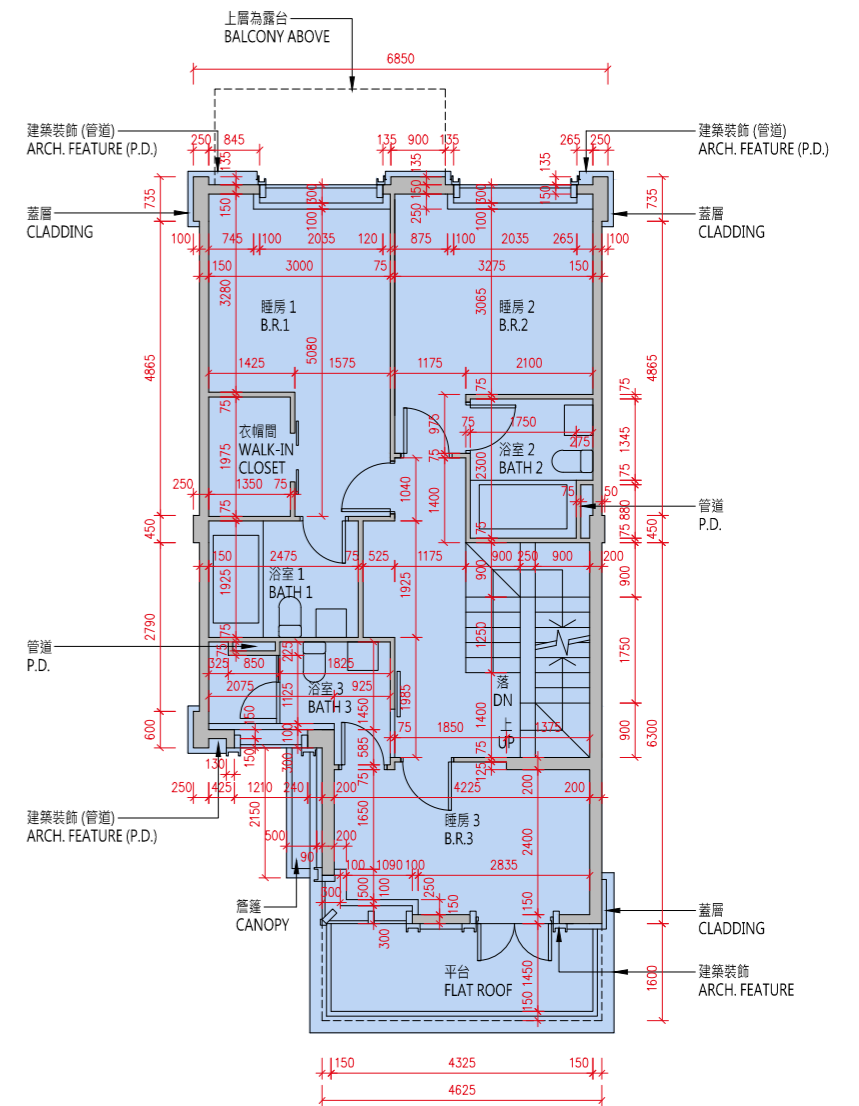

1樓平面圖
1/F Floor Plan

比例 : 0米/M 5米/M
Scale :

A10洋房
House A10

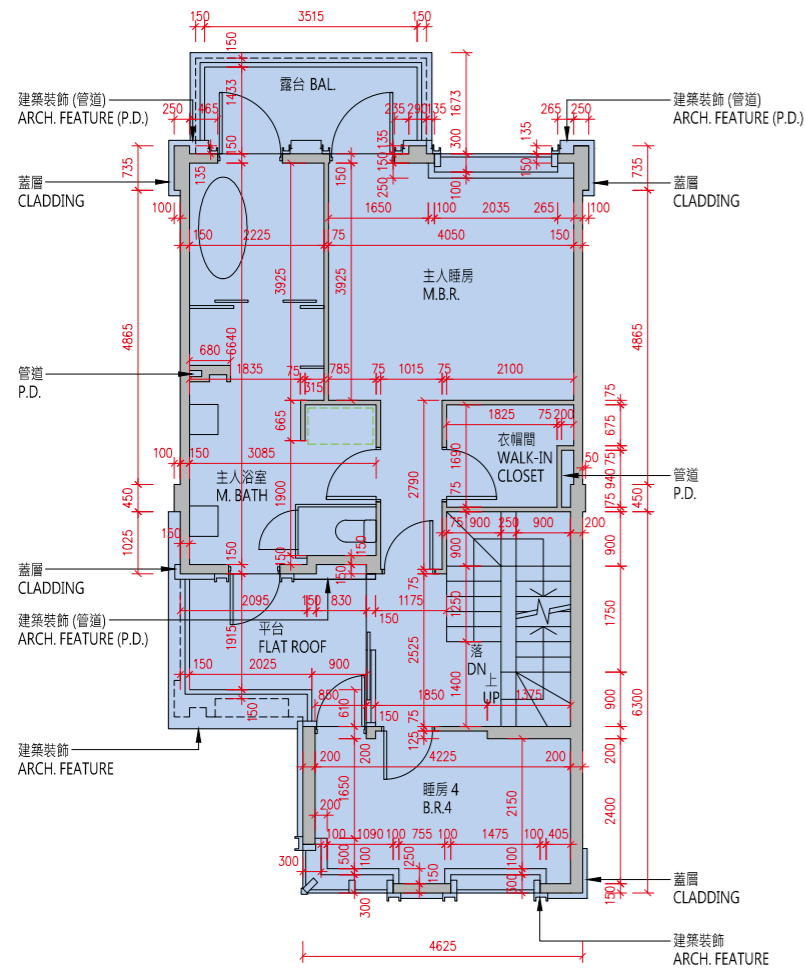
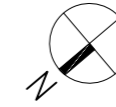

2樓平面圖
2/F Floor Plan

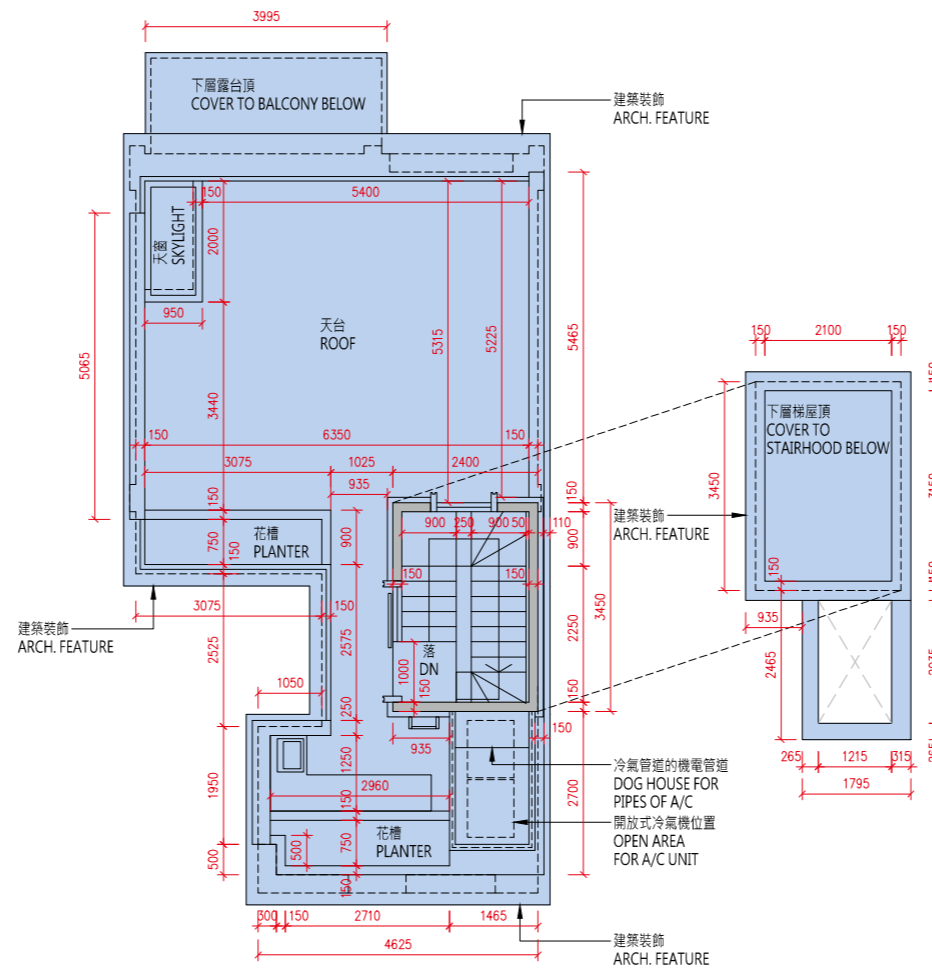

天台平面圖
Roof Floor Plan

比例：0米/M 5米/M
Scale :

樓層 Floor	地庫1樓 B1/F	地下 G/F	1樓 1/F	2樓 2/F	天台 Roof
層與層之間的高度 (毫米) Floor to Floor Height (mm)	5185, 5280, 5445, 5785	3750, 3970, 4000	3050, 3080, 3125, 3300	3500	N/A
樓板 (不包括灰泥) 的厚度 (毫米) Thickness of Floor Slab (excluding plaster) (mm)	200	150, 200	150, 200	150, 200	N/A

10 發展項目的住宅物業的樓面平面圖

FLOOR PLANS OF RESIDENTIAL PROPERTIES IN THE DEVELOPMENT

備註：

- (1) 批地文件特別條件第 8(d) 條規定：-
「(d) 在該地段已建成或擬建的住宅單位數目須不少於 515，並就本 (d) 分條而言：
 - (i) 一座擬作為單一家庭住宅的獨立屋、半獨立屋或排屋均被視為一個住宅單位；
 - (ii) 署長就獨立屋、半獨立屋或排屋是否構成或擬作為單一家庭住宅所作的決定將為最終決定，並對買方構成約束力；及
 - (iii) 署長就什麼構成一個住宅單位所作的決定將為最終決定，並對買方構成約束力。」
- (2) 公契及管理協議第 85 條規定：-
「管理人須在管理處備存一份由地政總署署長或任何其他不時替代其位的政府主管當局根據本公契附表三第 43 條所發出的同意的資料記錄，以供所有業主免費查閱及自費影印該資料記錄，並繳付合理費用。所有就此收取的費用一律撥入特別基金。」
- (3) 公契及管理協議附表三第 43 條規定：-
「43. 除非事先獲得地政總署署長或任何其他不時替代其位的政府主管當局的書面同意，否則任何業主不得進行或允許或容忍他人進行任何與住宅單位相關而可導致該住宅單位內部相連及通往任何毗連或毗鄰的住宅單位的工程，包括但不限於拆卸或更改任何分隔牆或任何樓板或天台樓板或任何間隔結構。而地政總署署長具有全權酌情給予同意或拒絕同意，倘若給予同意，業主須遵從地政總署署長按其全權酌情附加的任何條款及條件（包括支付費用）。」
- (4) 發展項目內所提供的住宅單位總數目為 590。
- (5) 平面圖所列的數字為以毫米標示之建築結構尺寸。
- (6) 因住宅物業的較高樓層的結構牆的厚度遞減，較高樓層的內部面積，一般比較低樓層的內部面積稍大。
- (7) 請參閱本售樓說明書第 20 頁為住宅物業樓面平面圖而設之備註及名詞及簡稱的圖例。

Notes:

- (1) Special Condition No. (8)(d) of the Land Grant stipulates that: -
“(d) the total number of residential units erected or to be erected on the lot shall not be less than 515, and for the purposes of this sub-clause (d):
 - (i) a detached, semi-detached or terraced house which is intended for use as a single family residence shall be regarded as a residential unit;
 - (ii) the decision of the Director as to whether a detached, semi-detached or terraced house constitutes or is intended for use as a single family residence shall be final and binding on the Purchaser; and
 - (iii) the decision of the Director as to what constitutes a residential unit shall be final and binding on the Purchaser.”
- (2) Clause 85 of the Deed of Mutual Covenant incorporating Management Agreement stipulates that: -
“85. The Manager shall deposit in the management office the record provided by the Director of Lands or any other Government authority in place of him from time to time of the information relating to the consent given under Clause 43 of the Third Schedule hereto for inspection by all Owners free of charge and taking copies at their own expense and on payment of a reasonable charge. All charges received shall be credited to the Special Fund.”
- (3) Clause 43 of the Third Schedule to the Deed of Mutual Covenant incorporating Management Agreement stipulates that: -
“43. No Owner shall carry out or permit or suffer to be carried out any works in connection with any Residential Unit, including but not limited to demolition or alteration of any partition wall or any floor or roof slab or any partition structure, which will result in such Residential Unit being internally linked to and accessible from any adjoining or adjacent Residential Unit, except with the prior written consent of the Director of Lands or any other Government authority in place of him from time to time, which consent may be given or withheld at his absolute discretion and if given, may be subject to such terms and conditions (including payment of fees) as may be imposed by him at his absolute discretion.”
- (4) The total number of residential units provided in the development is 590.
- (5) The dimensions in floor plans are all structural dimensions in millimeter.
- (6) The internal areas of the residential properties on the upper floors will generally be slightly larger than those on the lower floors because of the reducing thickness of the structural walls on the upper floors.
- (7) Please refer to page 20 of this sales brochure for the remarks and legends of the terms and abbreviations for the floor plans of residential properties.

A11洋房
House A11

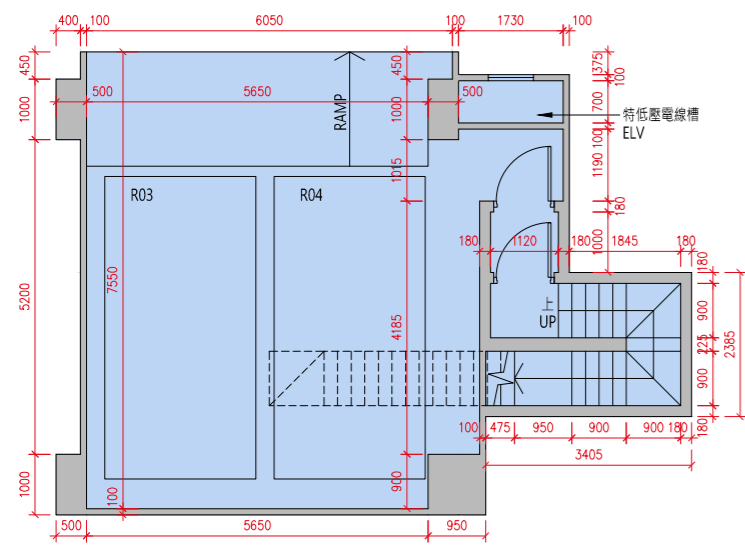

地庫1樓平面圖
B1/F Floor Plan

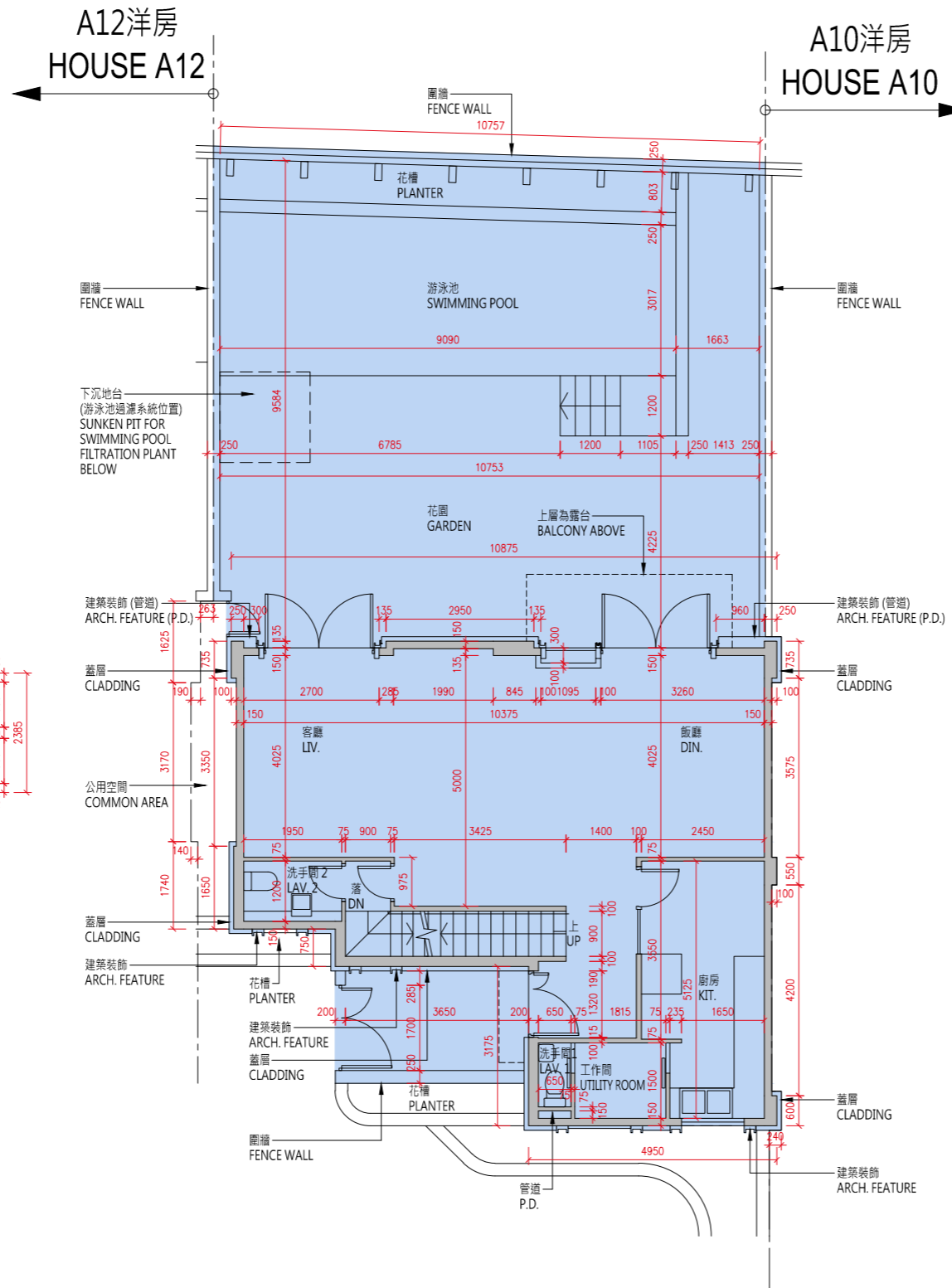

地下平面圖
G/F Floor Plan

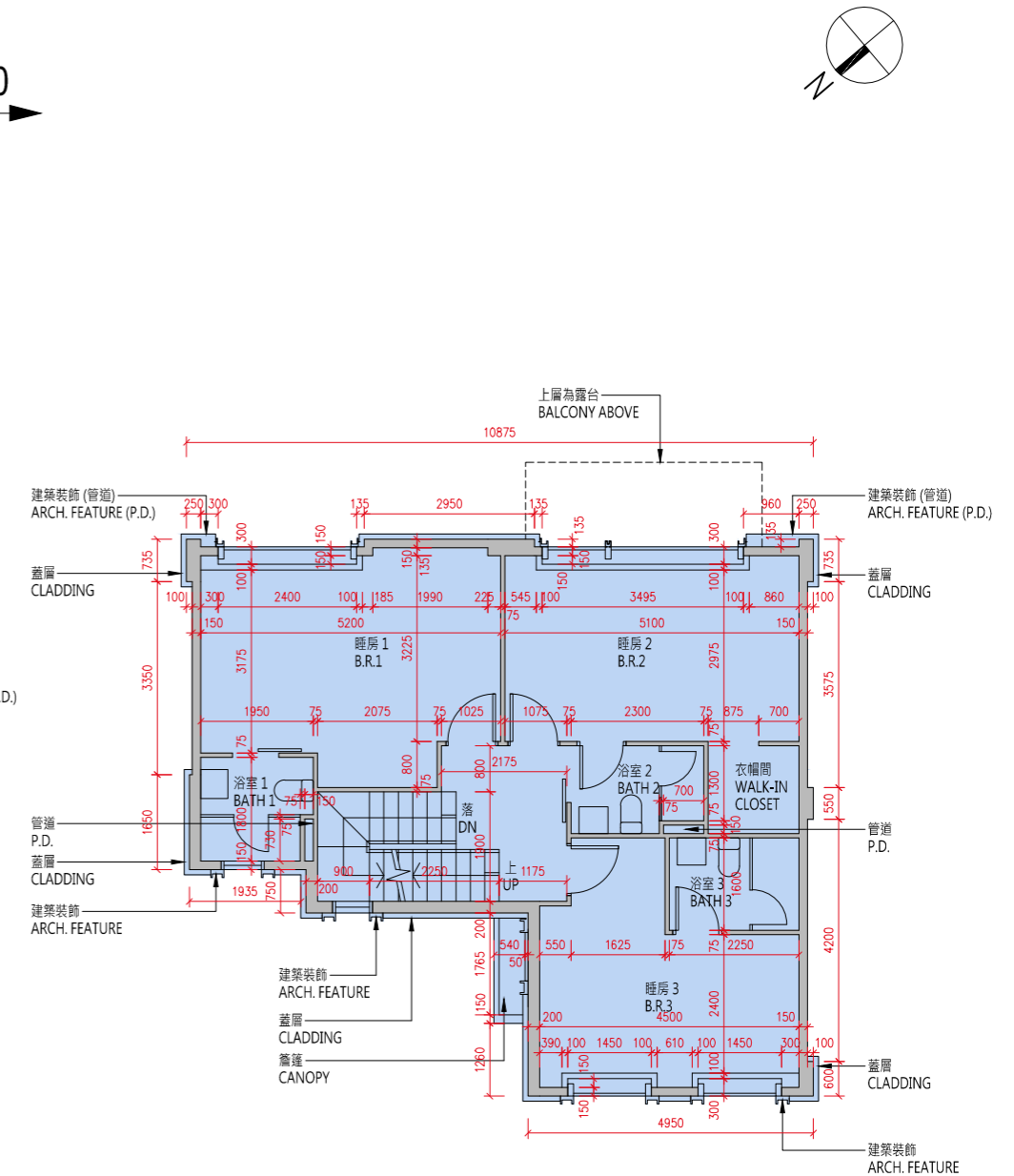

1樓平面圖
1/F Floor Plan

貼鄰住客停車位的面積 (不計算入停車位面積或實用面積) :
A11 洋房地庫 1 樓為 23.961 平方米 (258 平方呎) 。
Area adjoining residential parking space (not included in the area of parking space or saleable area): House A11 on B1/F is 23.961 sq.m. (258sq.ft.)

比例 : 0米/M 5米/M
Scale :

10 發展項目的住宅物業的樓面平面圖 FLOOR PLANS OF RESIDENTIAL PROPERTIES IN THE DEVELOPMENT

A11洋房 House A11

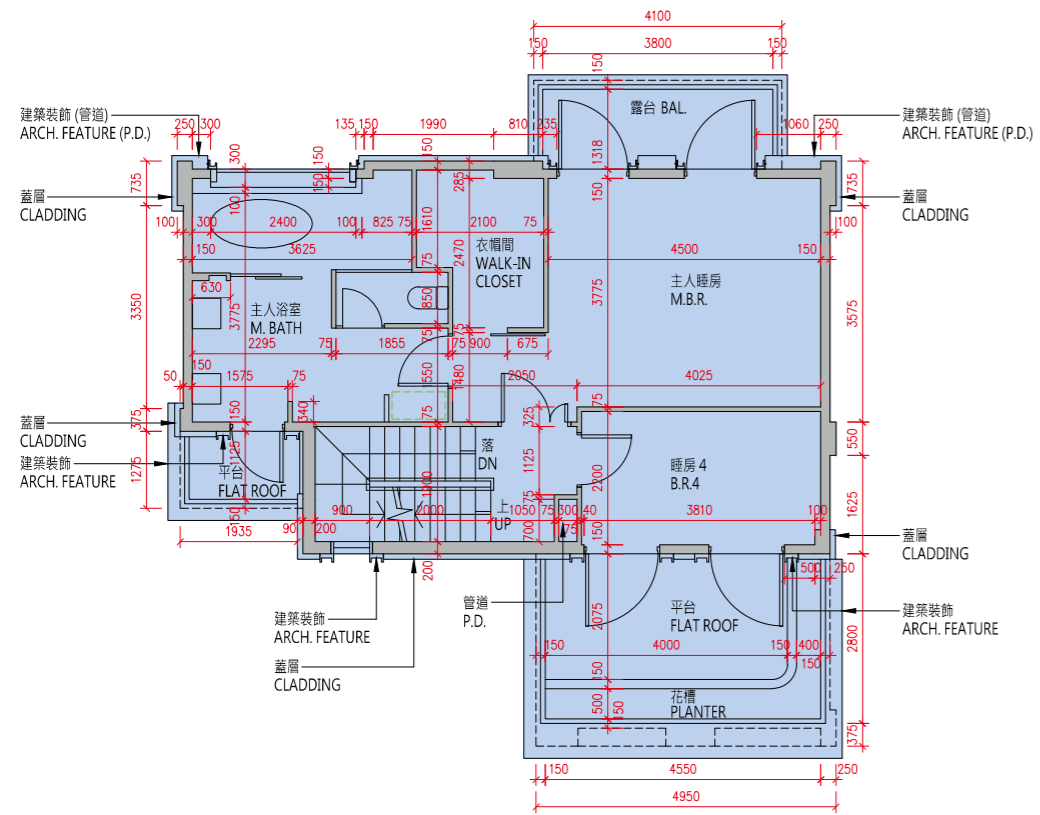
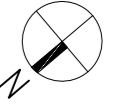

2樓平面圖
2/F Floor Plan

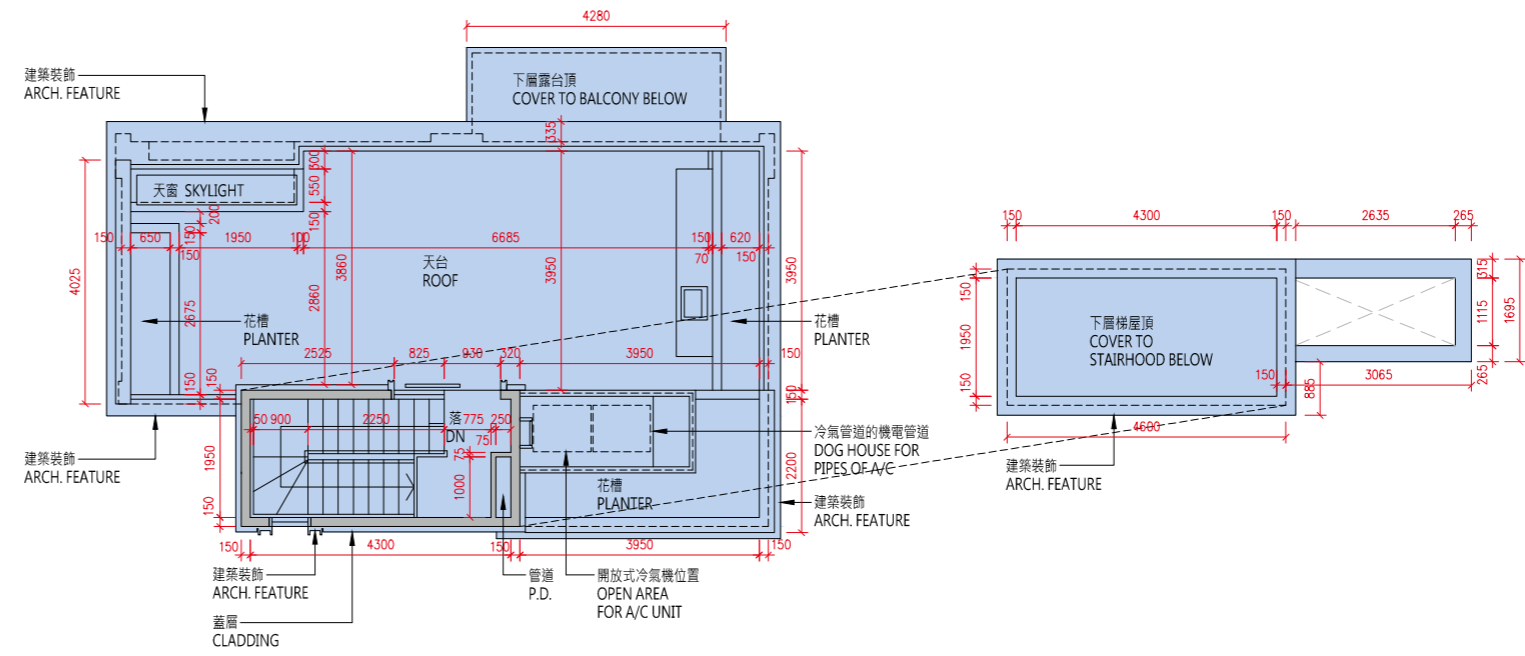

天台平面圖
Roof Floor Plan

比例：0米/M 5米/M
Scale: 5米/M

樓層 Floor	地庫1樓 B1/F	地下 G/F	1樓 1/F	2樓 2/F	天台 Roof
層與層之間的高度 (毫米) Floor to Floor Height (mm)	4540, 5250, 5615	3970, 4000	3050, 3080, 3125, 3300	3500	N/A
樓板 (不包括灰泥) 的厚度 (毫米) Thickness of Floor Slab (excluding plaster) (mm)	200	150, 200	150, 200	150, 200	N/A

備註：

(1) 批地文件特別條件第 8(d) 條規定：-

「(d) 在該地段已建成或擬建的住宅單位數目須不少於 515，並就本 (d) 分條而言：

- (i) 一座擬作為單一家庭住宅的獨立屋、半獨立屋或排屋均被視為一個住宅單位；
- (ii) 署長就獨立屋、半獨立屋或排屋是否構成或擬作為單一家庭住宅所作的決定將為最終決定，並對買方構成約束力；及
- (iii) 署長就什麼構成一個住宅單位所作的決定將為最終決定，並對買方構成約束力。」

(2) 公契及管理協議第 85 條規定：-

「管理人須在管理處備存一份由地政總署署長或任何其他不時替代其位的政府主管當局根據本公契附表三第 43 條所發出的同意的資料記錄，以供所有業主免費查閱及自費影印該資料記錄，並繳付合理費用。所有就此收取的費用一律撥入特別基金。」

(3) 公契及管理協議附表三第 43 條規定：-

「43. 除非事先獲得地政總署署長或任何其他不時替代其位的政府主管當局的書面同意，否則任何業主不得進行或允許或容忍他人進行任何與住宅單位相關而可導致該住宅單位內部相連及通往任何毗連或毗鄰的住宅單位的工程，包括但不限於拆卸或更改任何分隔牆或任何樓板或天台樓板或任何間隔結構。而地政總署署長具有全權酌情給予同意或拒絕同意，倘若給予同意，業主須遵從地政總署署長按其全權酌情附加的任何條款及條件（包括支付費用）。」

(4) 發展項目內所提供的住宅單位總數目為 590。

(5) 平面圖所列的數字為以毫米標示之建築結構尺寸。

(6) 因住宅物業的較高樓層的結構牆的厚度遞減，較高樓層的內部面積，一般比較低樓層的內部面積稍大。

(7) 請參閱本售樓說明書第 20 頁為住宅物業樓面平面圖而設之備註及名詞及簡稱的圖例。

Notes:

(1) Special Condition No. (8)(d) of the Land Grant stipulates that: -

“(d) the total number of residential units erected or to be erected on the lot shall not be less than 515, and for the purposes of this sub-clause (d):

- (i) a detached, semi-detached or terraced house which is intended for use as a single family residence shall be regarded as a residential unit;
- (ii) the decision of the Director as to whether a detached, semi-detached or terraced house constitutes or is intended for use as a single family residence shall be final and binding on the Purchaser; and
- (iii) the decision of the Director as to what constitutes a residential unit shall be final and binding on the Purchaser.”

(2) Clause 85 of the Deed of Mutual Covenant incorporating Management Agreement stipulates that: -

“85. The Manager shall deposit in the management office the record provided by the Director of Lands or any other Government authority in place of him from time to time of the information relating to the consent given under Clause 43 of the Third Schedule hereto for inspection by all Owners free of charge and taking copies at their own expense and on payment of a reasonable charge. All charges received shall be credited to the Special Fund.”

(3) Clause 43 of the Third Schedule to the Deed of Mutual Covenant incorporating Management Agreement stipulates that: -

“43. No Owner shall carry out or permit or suffer to be carried out any works in connection with any Residential Unit, including but not limited to demolition or alteration of any partition wall or any floor or roof slab or any partition structure, which will result in such Residential Unit being internally linked to and accessible from any adjoining or adjacent Residential Unit, except with the prior written consent of the Director of Lands or any other Government authority in place of him from time to time, which consent may be given or withheld at his absolute discretion and if given, may be subject to such terms and conditions (including payment of fees) as may be imposed by him at his absolute discretion.”

(4) The total number of residential units provided in the development is 590.

(5) The dimensions in floor plans are all structural dimensions in millimeter.

(6) The internal areas of the residential properties on the upper floors will generally be slightly larger than those on the lower floors because of the reducing thickness of the structural walls on the upper floors.

(7) Please refer to page 20 of this sales brochure for the remarks and legends of the terms and abbreviations for the floor plans of residential properties.

A12洋房
House A12

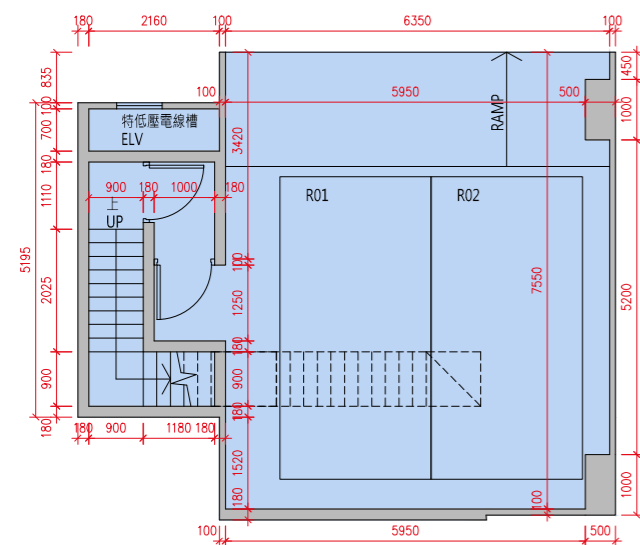

地庫1樓平面圖
B1/F Floor Plan

貼鄰住客停車位的面積 (不計算入停車位面積或實用面積):
A12 洋房地庫 1 樓為 23.657 平方米 (255 平方呎)。
Area adjoining residential parking space (not included in the area of parking space or saleable area): House A12 on B1/F is 23.657 sq.m. (255sq.ft.)

A11洋房
HOUSE A11

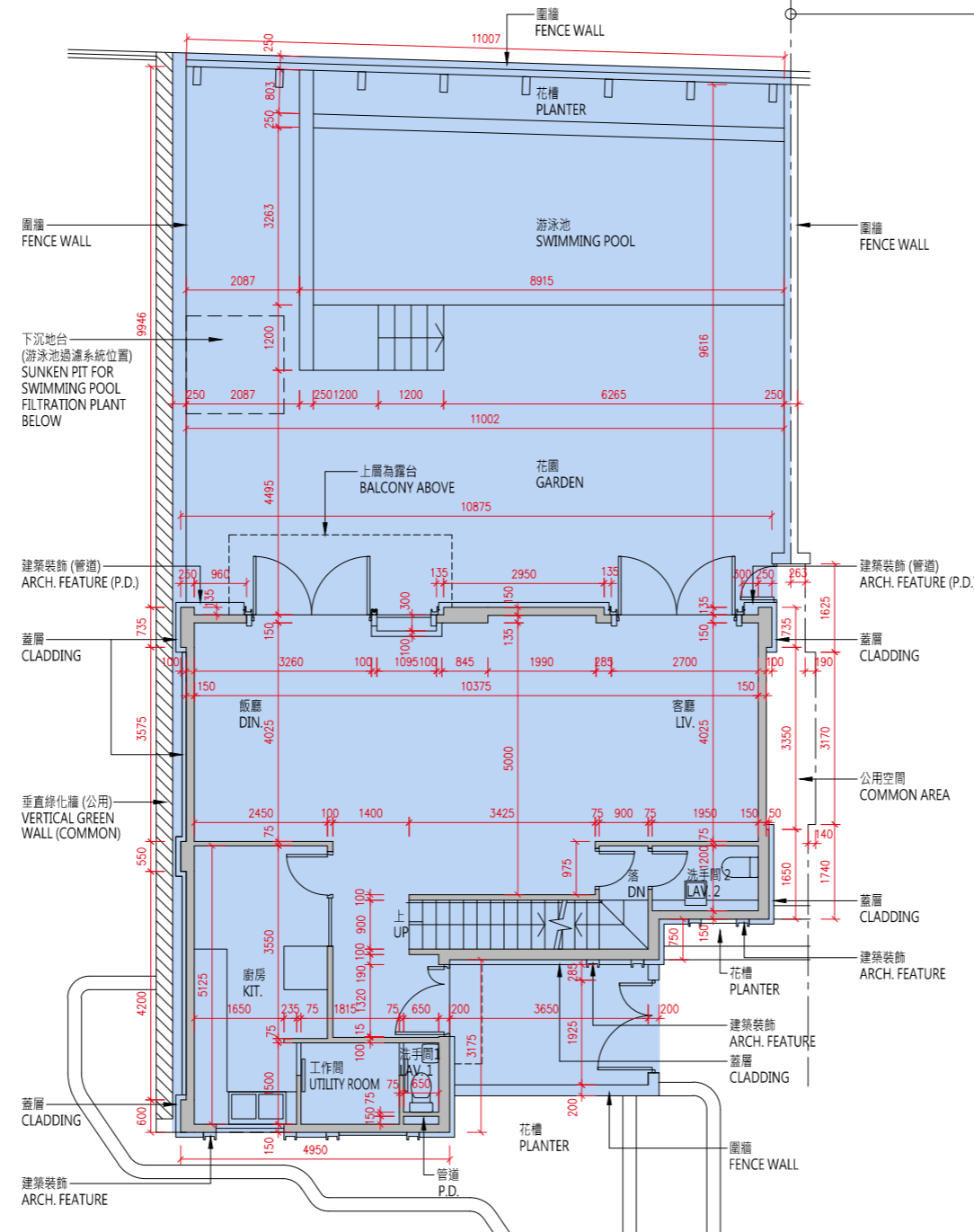

地下平面圖
G/F Floor Plan

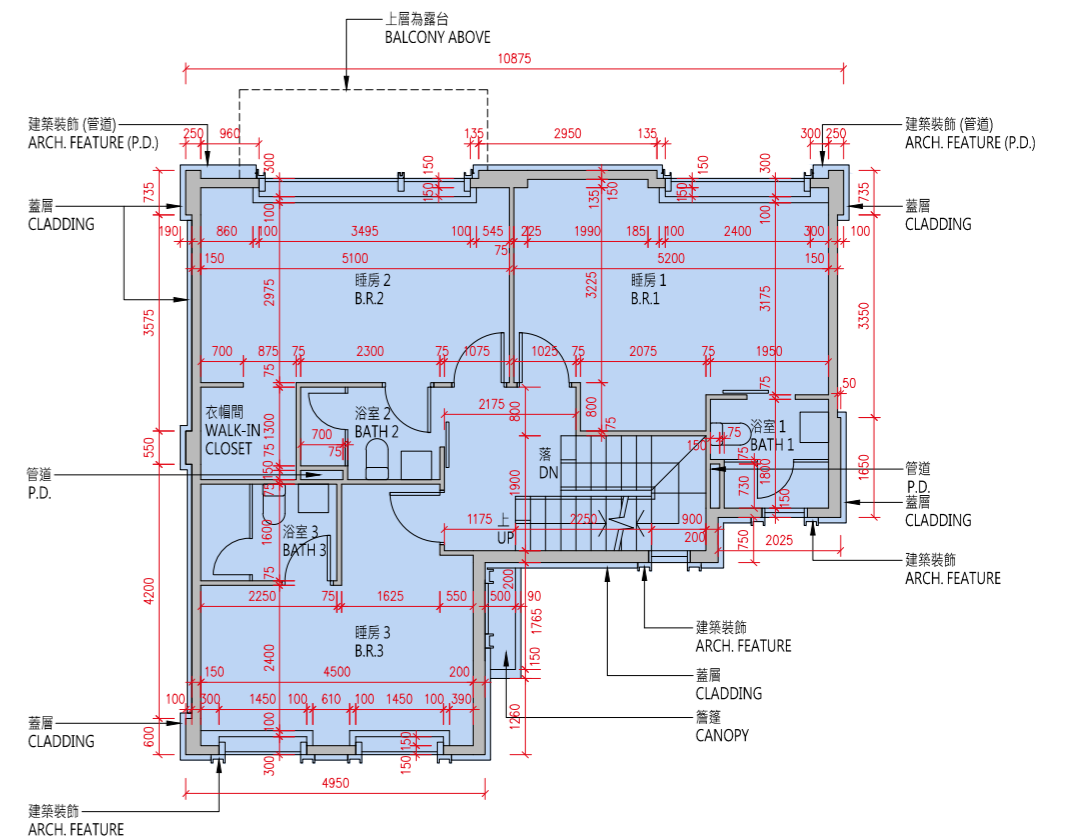

1樓平面圖
1/F Floor Plan

比例 : 0米/M 5米/M
Scale :

A12洋房
House A12

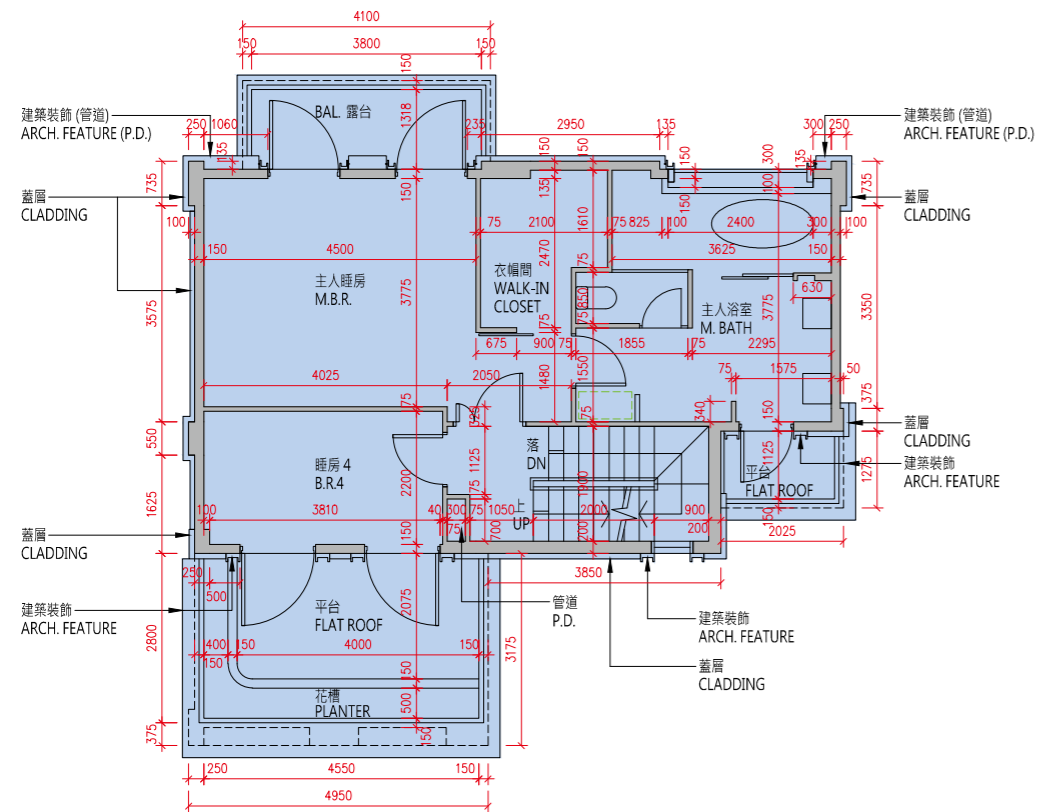
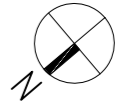

2樓平面圖
2/F Floor Plan

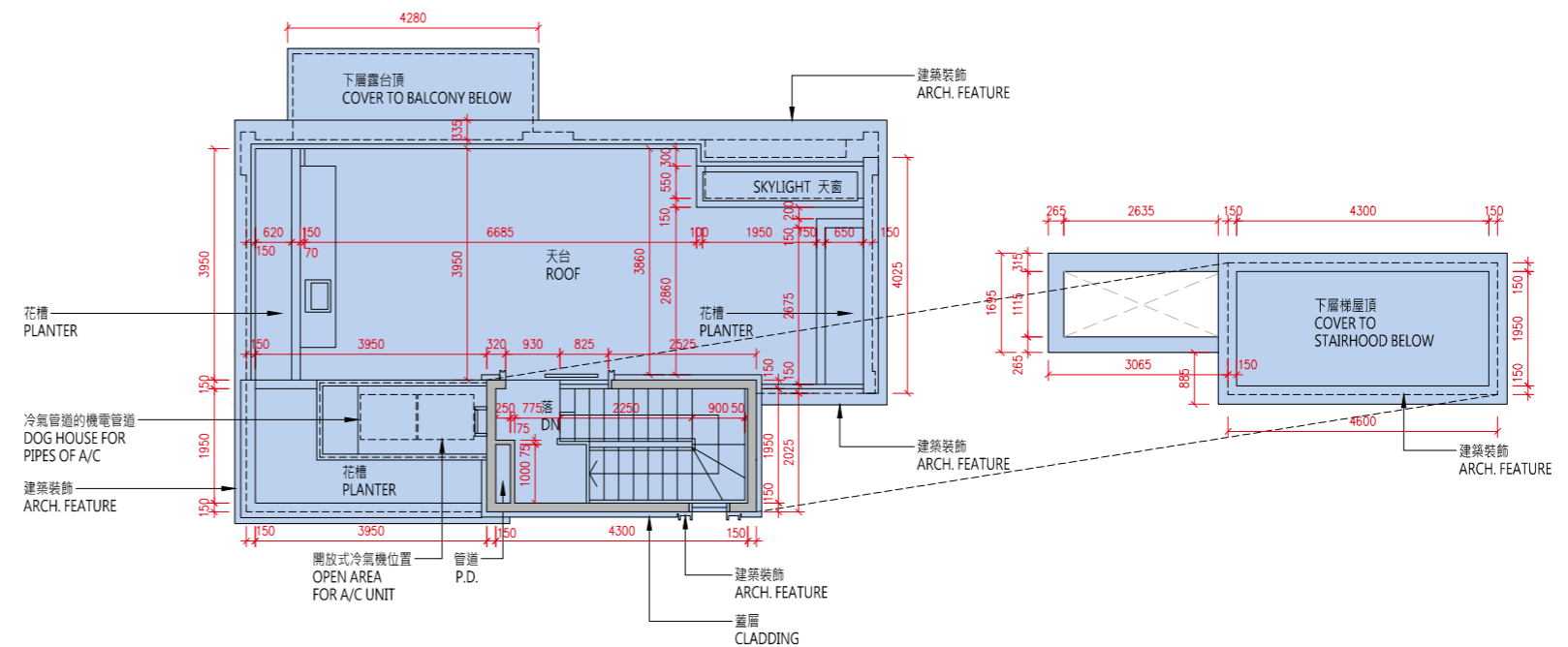

天台平面圖
Roof Floor Plan

比例：0米/M 5米/M
Scale: 5米/M

樓層 Floor	地庫1樓 B1/F	地下 G/F	1樓 1/F	2樓 2/F	天台 Roof
層與層之間的高度 (毫米) Floor to Floor Height (mm)	4280, 4990, 5390	3970, 4000	3050, 3080, 3125, 3300	3500	N/A
樓板 (不包括灰泥) 的厚度 (毫米) Thickness of Floor Slab (excluding plaster) (mm)	200	150, 200	150, 200	150, 200	N/A

10 發展項目的住宅物業的樓面平面圖

FLOOR PLANS OF RESIDENTIAL PROPERTIES IN THE DEVELOPMENT

備註：

- (1) 批地文件特別條件第 8(d) 條規定：-
「(d) 在該地段已建成或擬建的住宅單位數目須不少於 515，並就本 (d) 分條而言：
 - (i) 一座擬作為單一家庭住宅的獨立屋、半獨立屋或排屋均被視為一個住宅單位；
 - (ii) 署長就獨立屋、半獨立屋或排屋是否構成或擬作為單一家庭住宅所作的決定將為最終決定，並對買方構成約束力；及
 - (iii) 署長就什麼構成一個住宅單位所作的決定將為最終決定，並對買方構成約束力。」
- (2) 公契及管理協議第 85 條規定：-
「管理人須在管理處備存一份由地政總署署長或任何其他不時替代其位的政府主管當局根據本公契附表三第 43 條所發出的同意的資料記錄，以供所有業主免費查閱及自費影印該資料記錄，並繳付合理費用。所有就此收取的費用一律撥入特別基金。」
- (3) 公契及管理協議附表三第 43 條規定：-
「43. 除非事先獲得地政總署署長或任何其他不時替代其位的政府主管當局的書面同意，否則任何業主不得進行或允許或容忍他人進行任何與住宅單位相關而可導致該住宅單位內部相連及通往任何毗連或毗鄰的住宅單位的工程，包括但不限於拆卸或更改任何分隔牆或任何樓板或天台樓板或任何間隔結構。而地政總署署長具有全權酌情給予同意或拒絕同意，倘若給予同意，業主須遵從地政總署署長按其全權酌情附加的任何條款及條件（包括支付費用）。」
- (4) 發展項目內所提供的住宅單位總數目為 590。
- (5) 平面圖所列的數字為以毫米標示之建築結構尺寸。
- (6) 因住宅物業的較高樓層的結構牆的厚度遞減，較高樓層的內部面積，一般比較低樓層的內部面積稍大。
- (7) 請參閱本售樓說明書第 20 頁為住宅物業樓面平面圖而設之備註及名詞及簡稱的圖例。

Notes:

- (1) Special Condition No. (8)(d) of the Land Grant stipulates that: -
“(d) the total number of residential units erected or to be erected on the lot shall not be less than 515, and for the purposes of this sub-clause (d):
 - (i) a detached, semi-detached or terraced house which is intended for use as a single family residence shall be regarded as a residential unit;
 - (ii) the decision of the Director as to whether a detached, semi-detached or terraced house constitutes or is intended for use as a single family residence shall be final and binding on the Purchaser; and
 - (iii) the decision of the Director as to what constitutes a residential unit shall be final and binding on the Purchaser.”
- (2) Clause 85 of the Deed of Mutual Covenant incorporating Management Agreement stipulates that: -
“85. The Manager shall deposit in the management office the record provided by the Director of Lands or any other Government authority in place of him from time to time of the information relating to the consent given under Clause 43 of the Third Schedule hereto for inspection by all Owners free of charge and taking copies at their own expense and on payment of a reasonable charge. All charges received shall be credited to the Special Fund.”
- (3) Clause 43 of the Third Schedule to the Deed of Mutual Covenant incorporating Management Agreement stipulates that: -
“43. No Owner shall carry out or permit or suffer to be carried out any works in connection with any Residential Unit, including but not limited to demolition or alteration of any partition wall or any floor or roof slab or any partition structure, which will result in such Residential Unit being internally linked to and accessible from any adjoining or adjacent Residential Unit, except with the prior written consent of the Director of Lands or any other Government authority in place of him from time to time, which consent may be given or withheld at his absolute discretion and if given, may be subject to such terms and conditions (including payment of fees) as may be imposed by him at his absolute discretion.”
- (4) The total number of residential units provided in the development is 590.
- (5) The dimensions in floor plans are all structural dimensions in millimeter.
- (6) The internal areas of the residential properties on the upper floors will generally be slightly larger than those on the lower floors because of the reducing thickness of the structural walls on the upper floors.
- (7) Please refer to page 20 of this sales brochure for the remarks and legends of the terms and abbreviations for the floor plans of residential properties.

B1洋房
House B1

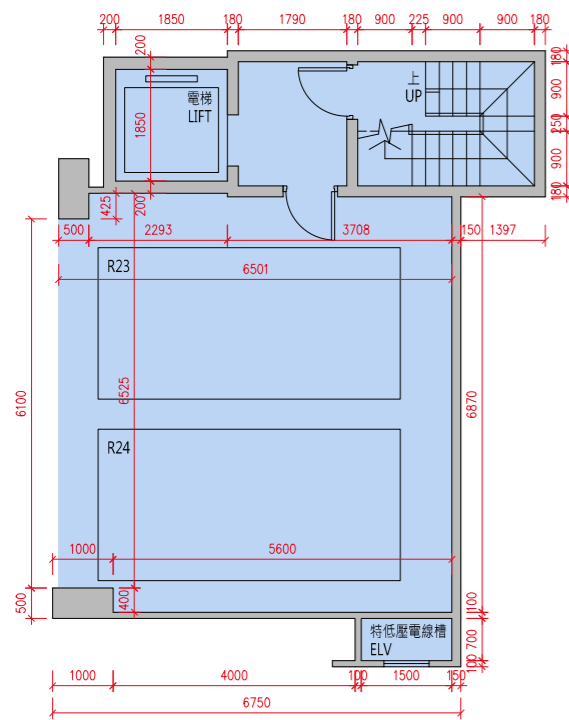

地庫1樓平面圖
B1/F Floor Plan

貼鄰住客停車位的面積 (不計算入停車位面積或實用面積) :
B1 洋房地庫 1 樓為 19.545 平方米 (210 平方呎)。
Area adjoining residential parking space (not included in the area of parking space or saleable area): House B1 on B1/F is 19.545 sq.m. (210sq.ft.)

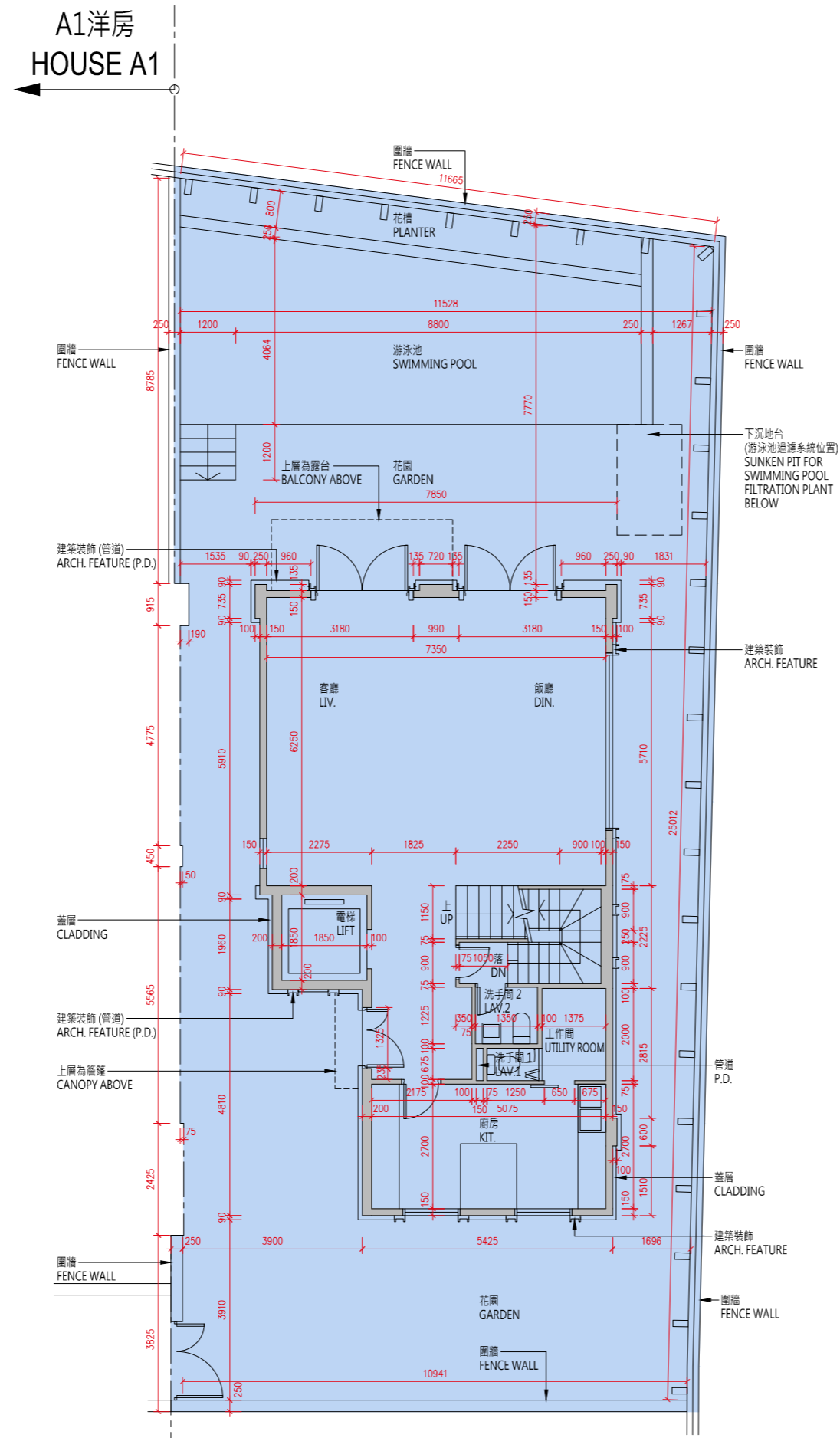

地下平面圖
G/F Floor Plan

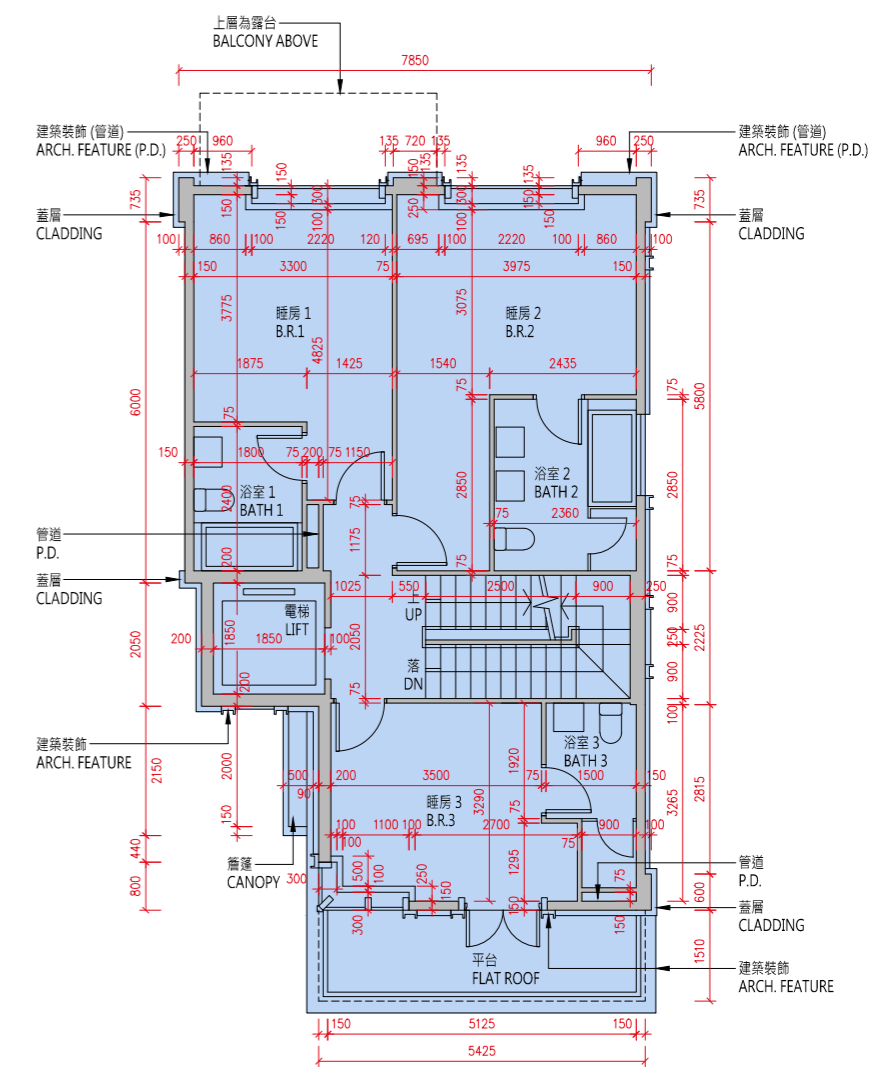

1樓平面圖
1/F Floor Plan

比例 :0米/M 5米/M
Scale :

10 發展項目的住宅物業的樓面平面圖 FLOOR PLANS OF RESIDENTIAL PROPERTIES IN THE DEVELOPMENT

B1洋房 House B1

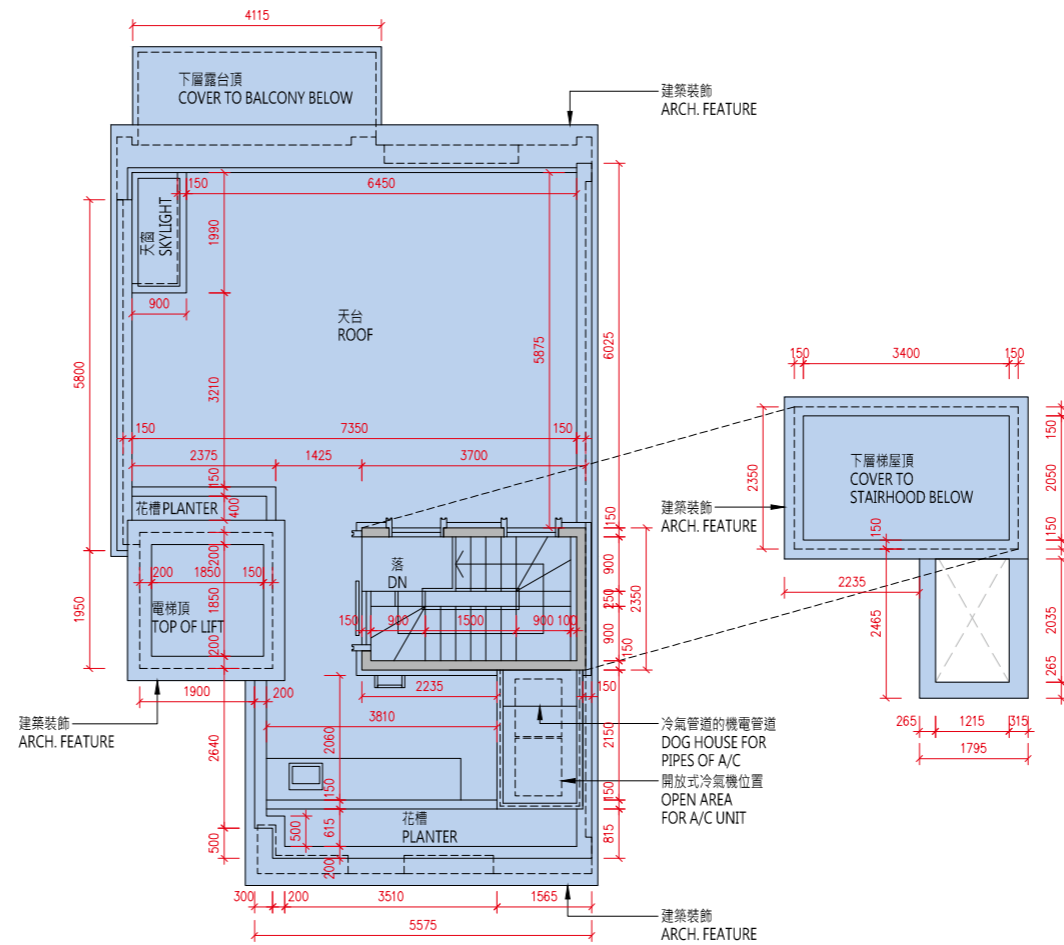
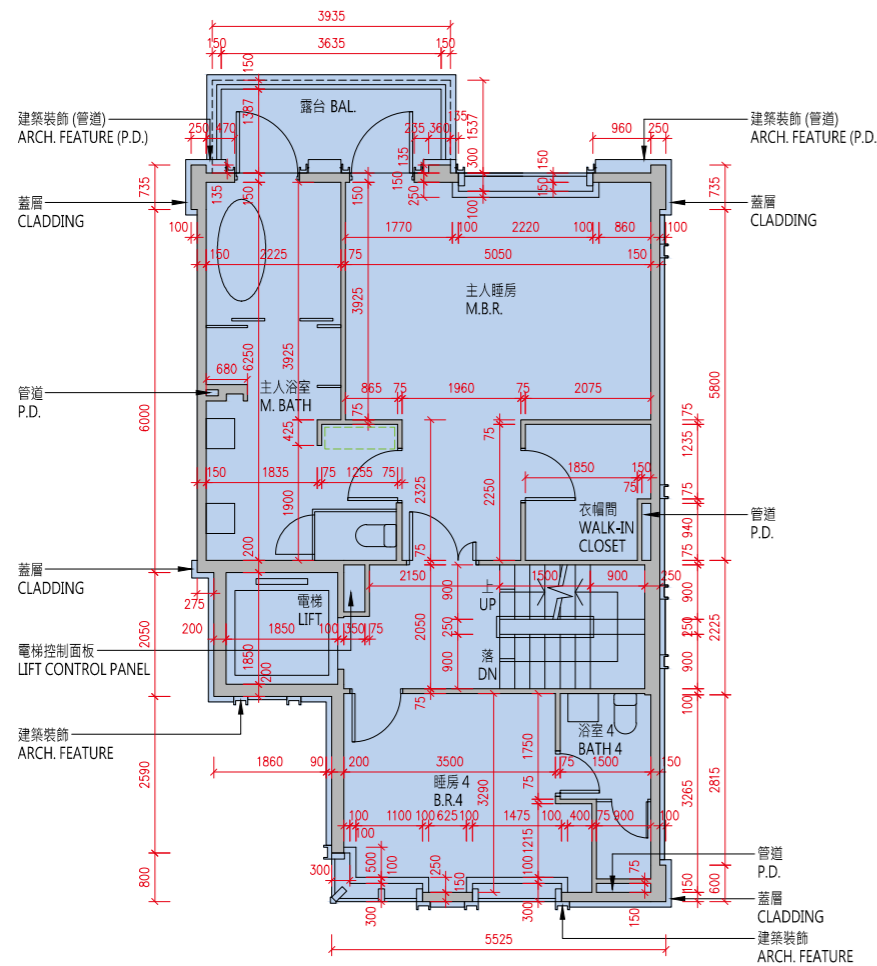
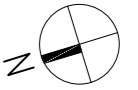

比例：0米/M 5米/M
Scale: 5米/M

樓層 Floor	地庫1樓 B1/F	地下 G/F	1樓 1/F	2樓 2/F	天台 Roof
層與層之間的高度 (毫米) Floor to Floor Height (mm)	4110, 4350, 5060	3750, 3970, 4000	3050, 3125, 3300	3500	N/A
樓板 (不包括灰泥) 的厚度 (毫米) Thickness of Floor Slab (excluding plaster) (mm)	200	150, 200	150, 200	150, 200	N/A

備註：

(1) 批地文件特別條件第 8(d) 條規定：-

「(d) 在該地段已建成或擬建的住宅單位數目須不少於 515，並就本 (d) 分條而言：

- (i) 一座擬作為單一家庭住宅的獨立屋、半獨立屋或排屋均被視為一個住宅單位；
- (ii) 署長就獨立屋、半獨立屋或排屋是否構成或擬作為單一家庭住宅所作的決定將為最終決定，並對買方構成約束力；及
- (iii) 署長就什麼構成一個住宅單位所作的決定將為最終決定，並對買方構成約束力。」

(2) 公契及管理協議第 85 條規定：-

「管理人須在管理處備存一份由地政總署署長或任何其他不時替代其位的政府主管當局根據本公契附表三第 43 條所發出的同意的資料記錄，以供所有業主免費查閱及自費影印該資料記錄，並繳付合理費用。所有就此收取的費用一律撥入特別基金。」

(3) 公契及管理協議附表三第 43 條規定：-

「43. 除非事先獲得地政總署署長或任何其他不時替代其位的政府主管當局的書面同意，否則任何業主不得進行或允許或容忍他人進行任何與住宅單位相關而可導致該住宅單位內部相連及通往任何毗連或毗鄰的住宅單位的工程，包括但不限於拆卸或更改任何分隔牆或任何樓板或天台樓板或任何間隔結構。而地政總署署長具有全權酌情給予同意或拒絕同意，倘若給予同意，業主須遵從地政總署署長按其全權酌情附加的任何條款及條件（包括支付費用）。」

(4) 發展項目內所提供的住宅單位總數目為 590。

(5) 平面圖所列的數字為以毫米標示之建築結構尺寸。

(6) 因住宅物業的較高樓層的結構牆的厚度遞減，較高樓層的內部面積，一般比較低樓層的內部面積稍大。

(7) 請參閱本售樓說明書第 20 頁為住宅物業樓面平面圖而設之備註及名詞及簡稱的圖例。

Notes:

(1) Special Condition No. (8)(d) of the Land Grant stipulates that: -

“(d) the total number of residential units erected or to be erected on the lot shall not be less than 515, and for the purposes of this sub-clause (d):

- (i) a detached, semi-detached or terraced house which is intended for use as a single family residence shall be regarded as a residential unit;
- (ii) the decision of the Director as to whether a detached, semi-detached or terraced house constitutes or is intended for use as a single family residence shall be final and binding on the Purchaser; and
- (iii) the decision of the Director as to what constitutes a residential unit shall be final and binding on the Purchaser.”

(2) Clause 85 of the Deed of Mutual Covenant incorporating Management Agreement stipulates that: -

“85. The Manager shall deposit in the management office the record provided by the Director of Lands or any other Government authority in place of him from time to time of the information relating to the consent given under Clause 43 of the Third Schedule hereto for inspection by all Owners free of charge and taking copies at their own expense and on payment of a reasonable charge. All charges received shall be credited to the Special Fund.”

(3) Clause 43 of the Third Schedule to the Deed of Mutual Covenant incorporating Management Agreement stipulates that: -

“43. No Owner shall carry out or permit or suffer to be carried out any works in connection with any Residential Unit, including but not limited to demolition or alteration of any partition wall or any floor or roof slab or any partition structure, which will result in such Residential Unit being internally linked to and accessible from any adjoining or adjacent Residential Unit, except with the prior written consent of the Director of Lands or any other Government authority in place of him from time to time, which consent may be given or withheld at his absolute discretion and if given, may be subject to such terms and conditions (including payment of fees) as may be imposed by him at his absolute discretion.”

(4) The total number of residential units provided in the development is 590.

(5) The dimensions in floor plans are all structural dimensions in millimeter.

(6) The internal areas of the residential properties on the upper floors will generally be slightly larger than those on the lower floors because of the reducing thickness of the structural walls on the upper floors.

(7) Please refer to page 20 of this sales brochure for the remarks and legends of the terms and abbreviations for the floor plans of residential properties.

B2洋房
House B2

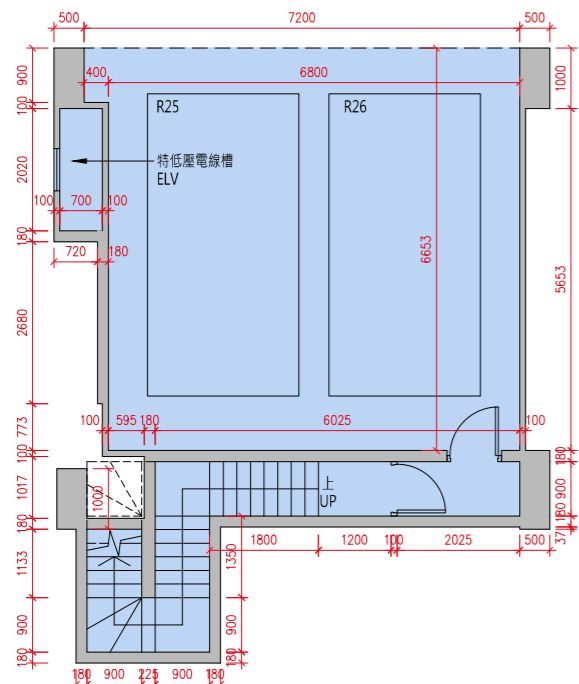

地庫1樓平面圖
B1/F Floor Plan

貼鄰住客停車位的面積 (不計算入停車位面積或實用面積) :
B2 洋房地庫 1 樓為 20.600 平方米 (222 平方呎)。
Area adjoining residential parking space (not included in the area of parking space or saleable area): House B2 on B1/F is 20.600 sq.m. (222sq.ft.)

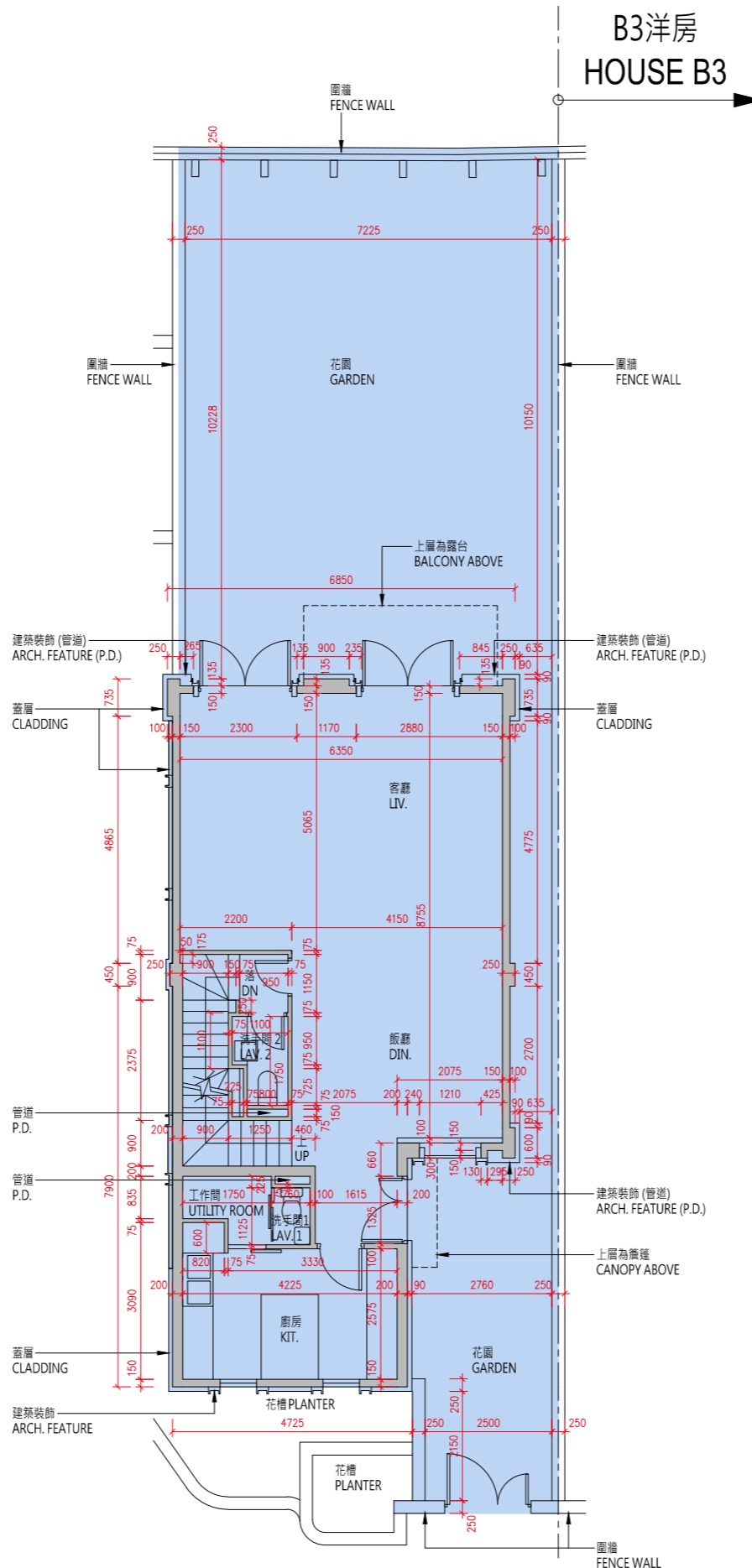

地下平面圖
G/F Floor Plan

B3洋房
HOUSE B3

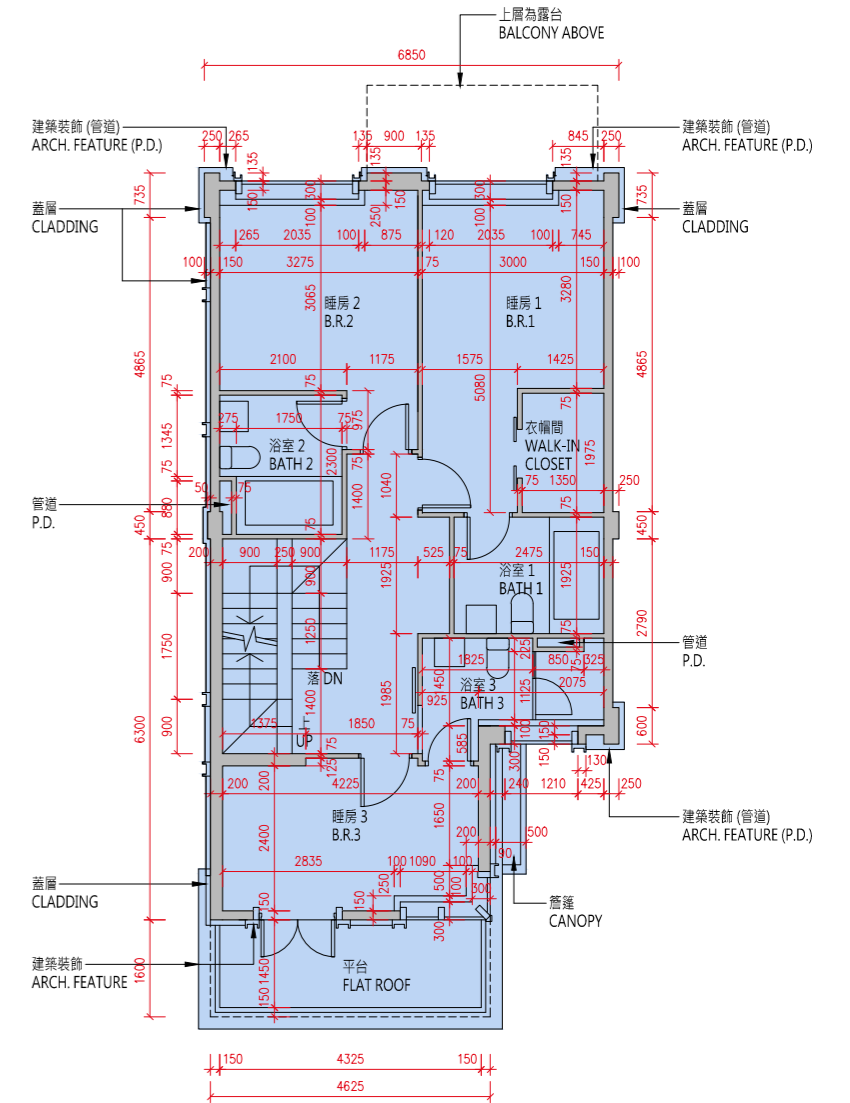

1樓平面圖
1/F Floor Plan

比例 : 0米/M 5米/M
Scale :



B2洋房
House B2

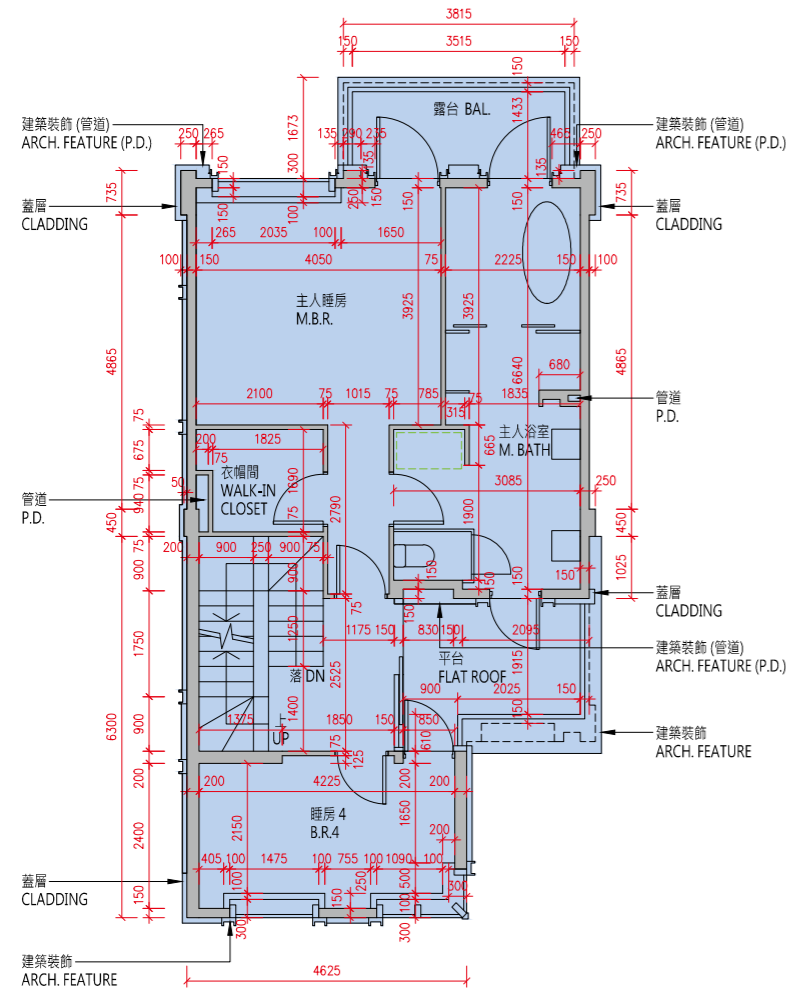

2樓平面圖
2/F Floor Plan

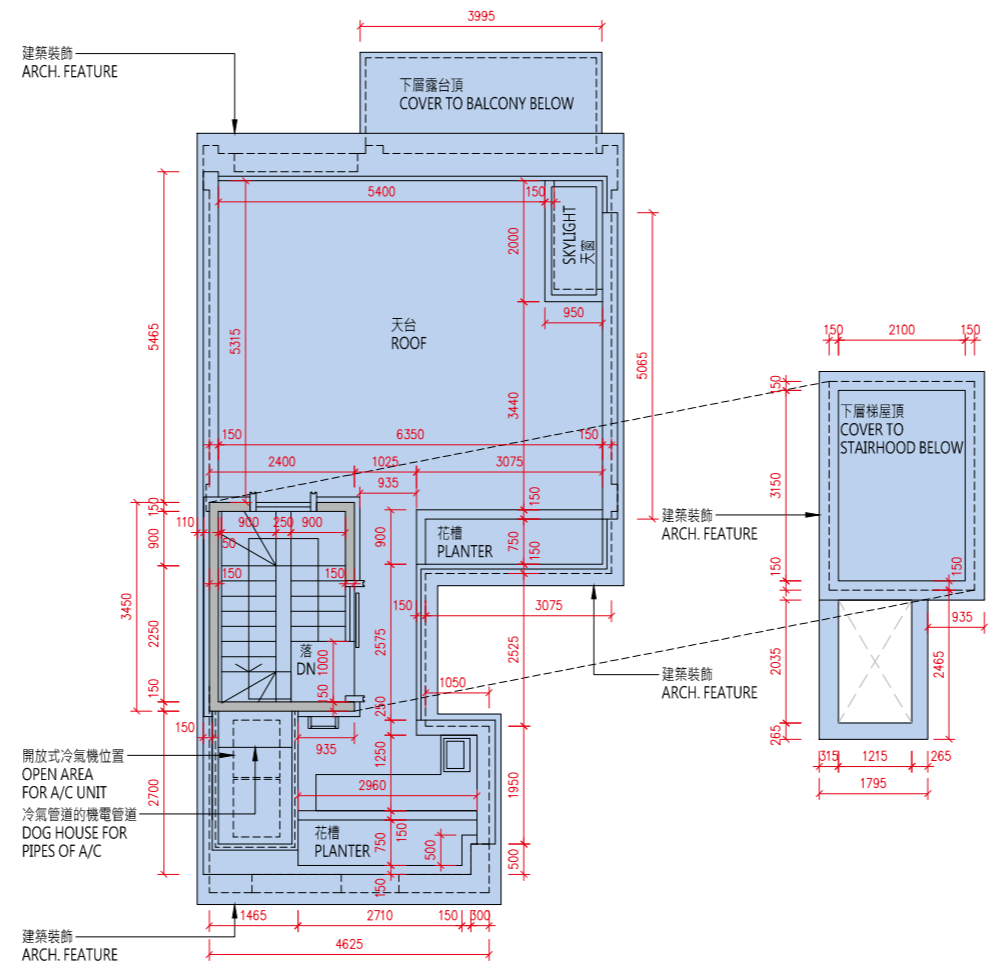

天台平面圖
Roof Floor Plan

比例：0米/M 5米/M
Scale :

樓層 Floor	地庫1樓 B1/F	地下 G/F	1樓 1/F	2樓 2/F	天台 Roof
層與層之間的高度 (毫米) Floor to Floor Height (mm)	4350, 4950, 5060	3750, 3970, 4000	3050, 3080, 3125, 3300	3500	N/A
樓板 (不包括灰泥) 的厚度 (毫米) Thickness of Floor Slab (excluding plaster) (mm)	200	150, 200	150, 200	150, 200	N/A

10 發展項目的住宅物業的樓面平面圖

FLOOR PLANS OF RESIDENTIAL PROPERTIES IN THE DEVELOPMENT

備註：

- (1) 批地文件特別條件第 8(d) 條規定：-
「(d) 在該地段已建成或擬建的住宅單位數目須不少於 515，並就本 (d) 分條而言：
 - (i) 一座擬作為單一家庭住宅的獨立屋、半獨立屋或排屋均被視為一個住宅單位；
 - (ii) 署長就獨立屋、半獨立屋或排屋是否構成或擬作為單一家庭住宅所作的決定將為最終決定，並對買方構成約束力；及
 - (iii) 署長就什麼構成一個住宅單位所作的決定將為最終決定，並對買方構成約束力。」
- (2) 公契及管理協議第 85 條規定：-
「管理人須在管理處備存一份由地政總署署長或任何其他不時替代其位的政府主管當局根據本公契附表三第 43 條所發出的同意的資料記錄，以供所有業主免費查閱及自費影印該資料記錄，並繳付合理費用。所有就此收取的費用一律撥入特別基金。」
- (3) 公契及管理協議附表三第 43 條規定：-
「43. 除非事先獲得地政總署署長或任何其他不時替代其位的政府主管當局的書面同意，否則任何業主不得進行或允許或容忍他人進行任何與住宅單位相關而可導致該住宅單位內部相連及通往任何毗連或毗鄰的住宅單位的工程，包括但不限於拆卸或更改任何分隔牆或任何樓板或天台樓板或任何間隔結構。而地政總署署長具有全權酌情給予同意或拒絕同意，倘若給予同意，業主須遵從地政總署署長按其全權酌情附加的任何條款及條件（包括支付費用）。」
- (4) 發展項目內所提供的住宅單位總數目為 590。
- (5) 平面圖所列的數字為以毫米標示之建築結構尺寸。
- (6) 因住宅物業的較高樓層的結構牆的厚度遞減，較高樓層的內部面積，一般比較低樓層的內部面積稍大。
- (7) 請參閱本售樓說明書第 20 頁為住宅物業樓面平面圖而設之備註及名詞及簡稱的圖例。

Notes:

- (1) Special Condition No. (8)(d) of the Land Grant stipulates that: -
“(d) the total number of residential units erected or to be erected on the lot shall not be less than 515, and for the purposes of this sub-clause (d):
 - (i) a detached, semi-detached or terraced house which is intended for use as a single family residence shall be regarded as a residential unit;
 - (ii) the decision of the Director as to whether a detached, semi-detached or terraced house constitutes or is intended for use as a single family residence shall be final and binding on the Purchaser; and
 - (iii) the decision of the Director as to what constitutes a residential unit shall be final and binding on the Purchaser.”
- (2) Clause 85 of the Deed of Mutual Covenant incorporating Management Agreement stipulates that: -
“85. The Manager shall deposit in the management office the record provided by the Director of Lands or any other Government authority in place of him from time to time of the information relating to the consent given under Clause 43 of the Third Schedule hereto for inspection by all Owners free of charge and taking copies at their own expense and on payment of a reasonable charge. All charges received shall be credited to the Special Fund.”
- (3) Clause 43 of the Third Schedule to the Deed of Mutual Covenant incorporating Management Agreement stipulates that: -
“43. No Owner shall carry out or permit or suffer to be carried out any works in connection with any Residential Unit, including but not limited to demolition or alteration of any partition wall or any floor or roof slab or any partition structure, which will result in such Residential Unit being internally linked to and accessible from any adjoining or adjacent Residential Unit, except with the prior written consent of the Director of Lands or any other Government authority in place of him from time to time, which consent may be given or withheld at his absolute discretion and if given, may be subject to such terms and conditions (including payment of fees) as may be imposed by him at his absolute discretion.”
- (4) The total number of residential units provided in the development is 590.
- (5) The dimensions in floor plans are all structural dimensions in millimeter.
- (6) The internal areas of the residential properties on the upper floors will generally be slightly larger than those on the lower floors because of the reducing thickness of the structural walls on the upper floors.
- (7) Please refer to page 20 of this sales brochure for the remarks and legends of the terms and abbreviations for the floor plans of residential properties.

10 發展項目的住宅物業的樓面平面圖 FLOOR PLANS OF RESIDENTIAL PROPERTIES IN THE DEVELOPMENT

B3洋房 House B3

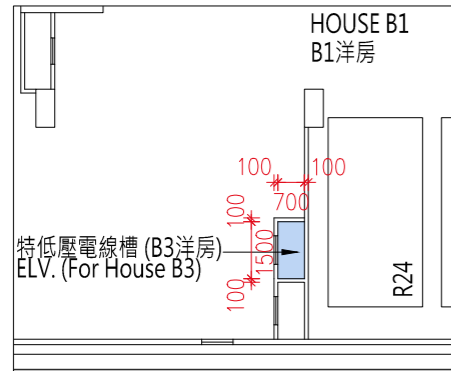

地庫1樓索引圖
B1/F Key Plan

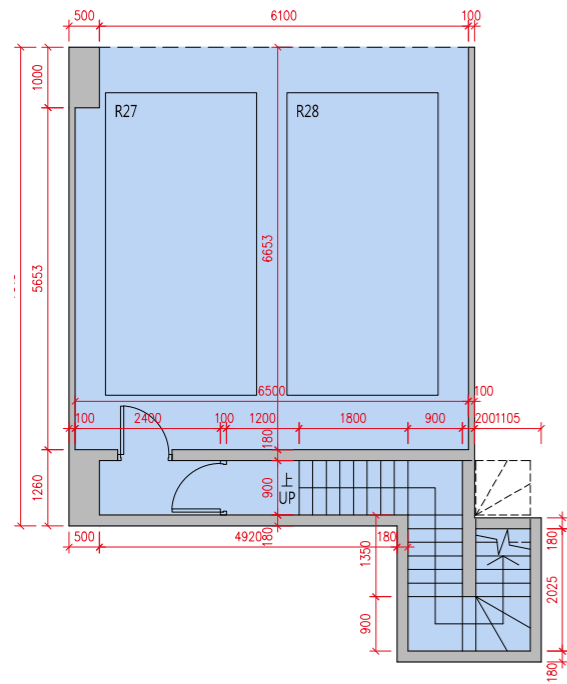

地庫1樓平面圖
B1/F Floor Plan

貼鄰住客停車位的面積 (不計算入停車位面積或實用面積) :
B3 洋房地庫 1 樓為 17.844 平方米 (192 平方呎)。
Area adjoining residential parking space (not included in the area of parking space or saleable area): House B3 on B1/F is 17.844 sq.m. (192sq.ft.)

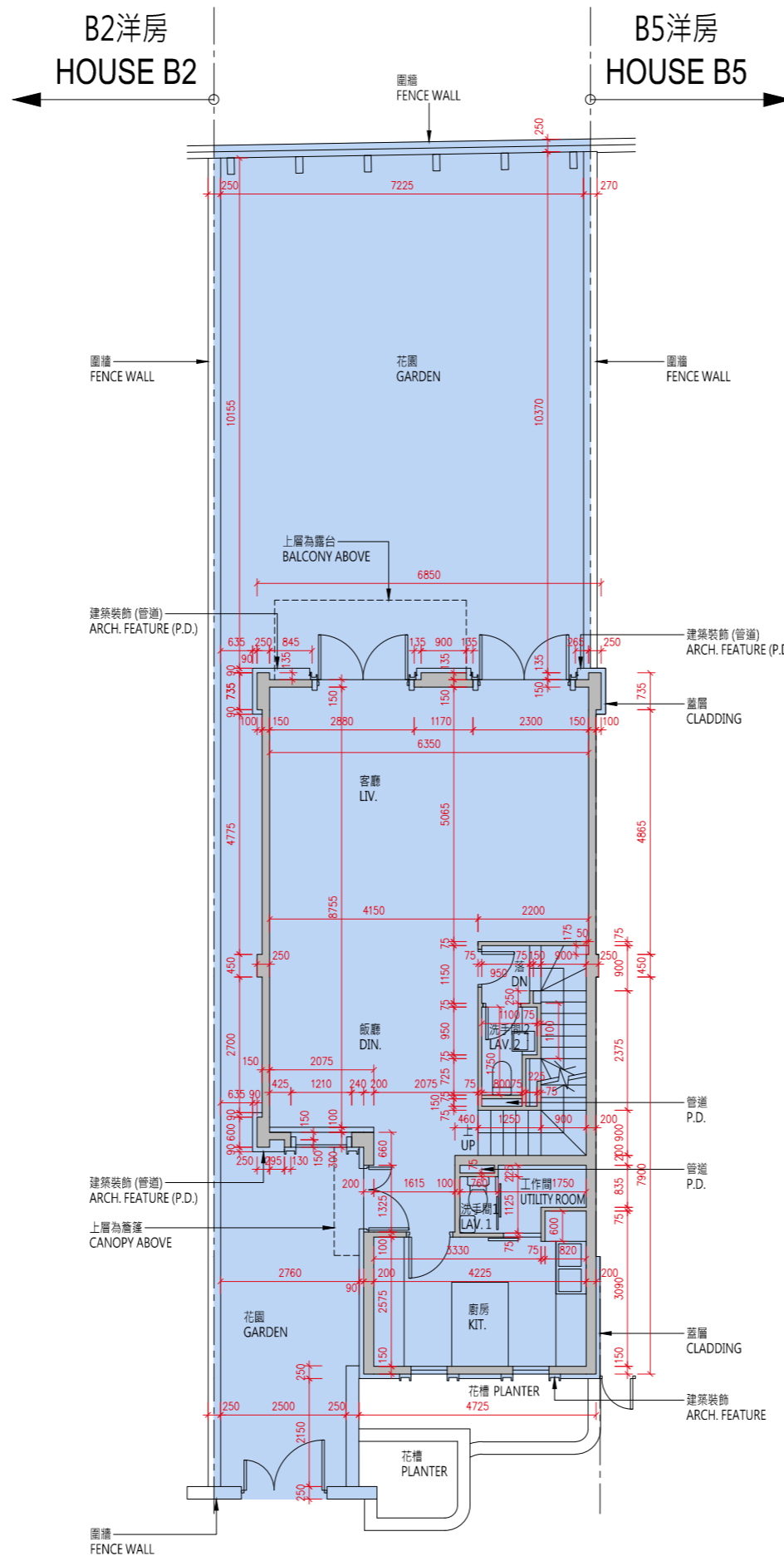

地下平面圖
G/F Floor Plan

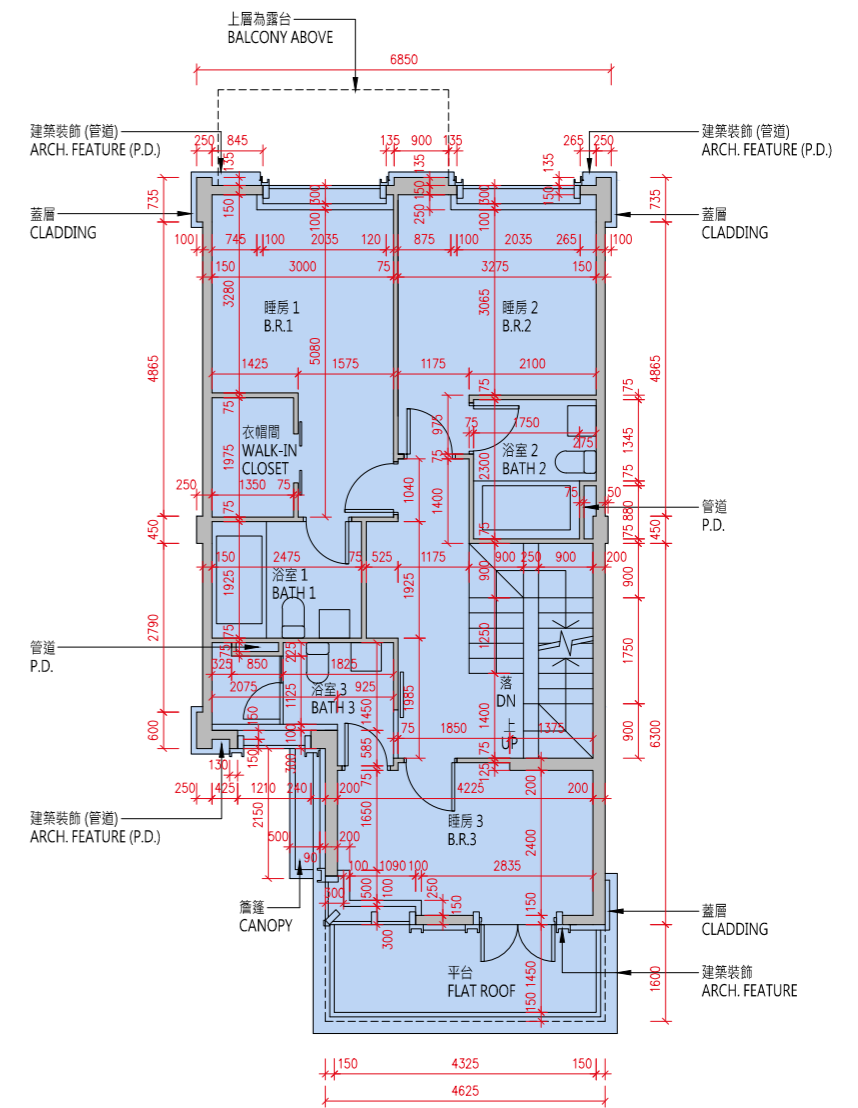

1樓平面圖
1/F Floor Plan

比例 : 0米/M 5米/M
Scale :



B3洋房
House B3

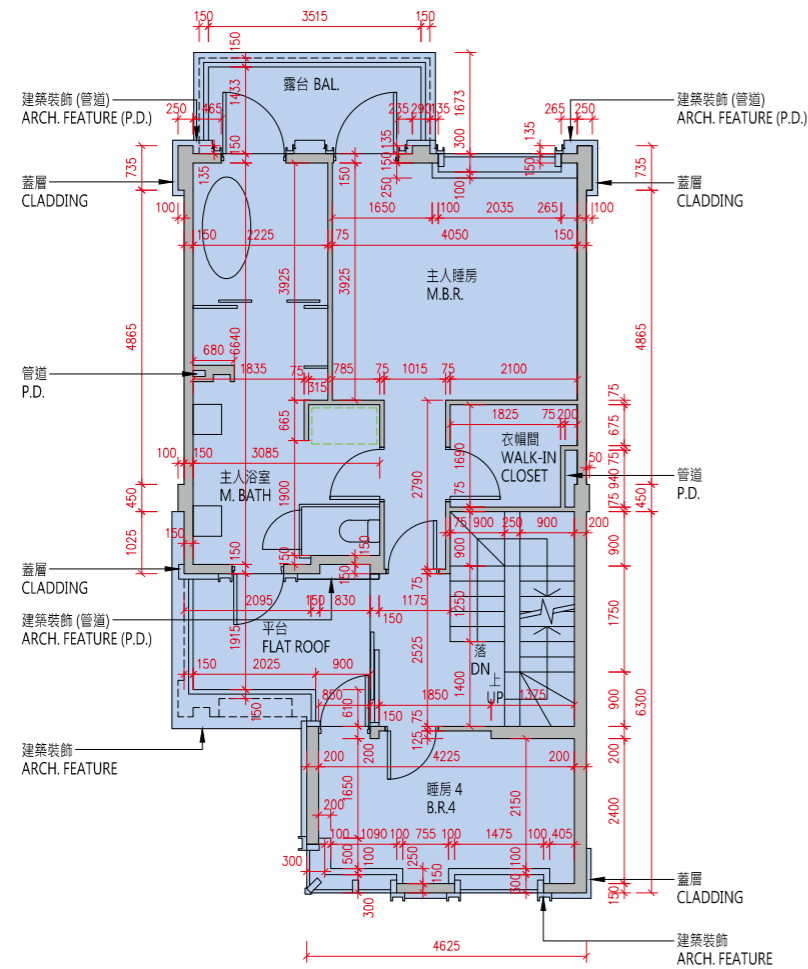

2樓平面圖
2/F Floor Plan

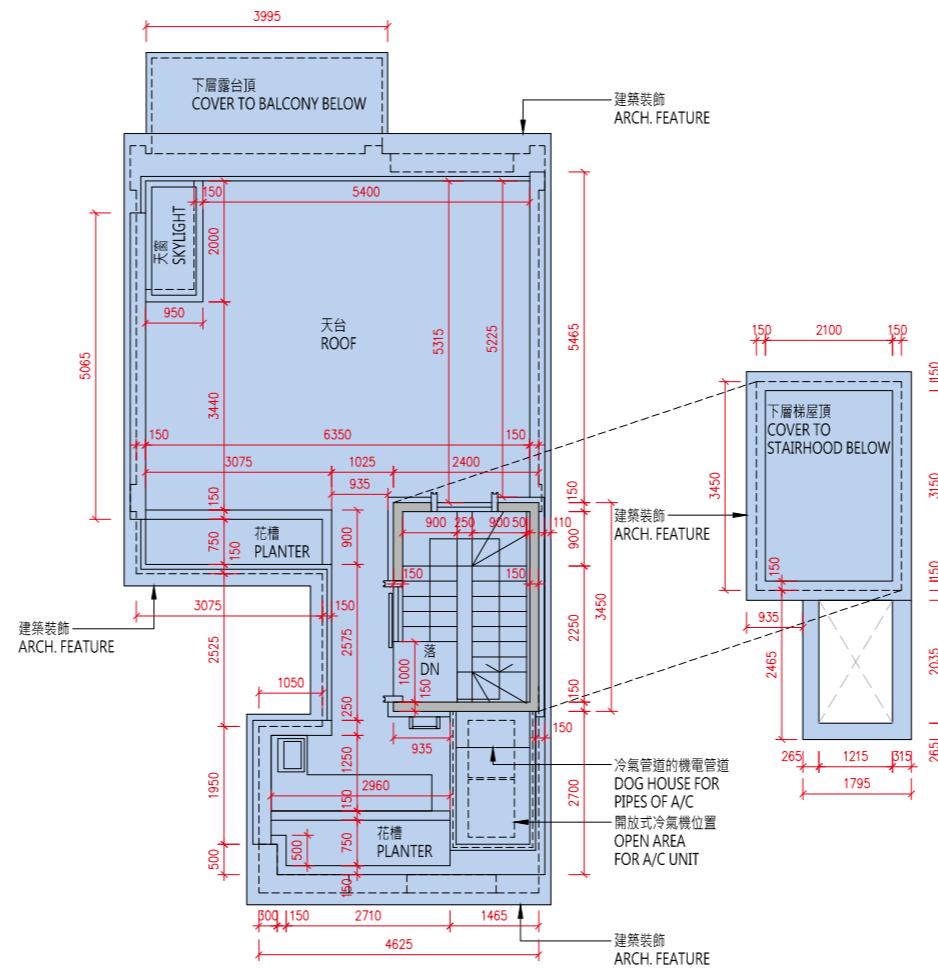

天台平面圖
Roof Floor Plan

比例：0米/M 5米/M
Scale : 5米/M

樓層 Floor	地庫1樓 B1/F	地下 G/F	1樓 1/F	2樓 2/F	天台 Roof
層與層之間的高度 (毫米) Floor to Floor Height (mm)	4350, 4950, 5060	3750, 3970, 4000	3050, 3080, 3125, 3300	3500	N/A
樓板 (不包括灰泥) 的厚度 (毫米) Thickness of Floor Slab (excluding plaster) (mm)	200	150, 200	150, 200	150, 200	N/A

備註：

(1) 批地文件特別條件第 8(d) 條規定：-

「(d) 在該地段已建成或擬建的住宅單位數目須不少於 515，並就本 (d) 分條而言：

- (i) 一座擬作為單一家庭住宅的獨立屋、半獨立屋或排屋均被視為一個住宅單位；
- (ii) 署長就獨立屋、半獨立屋或排屋是否構成或擬作為單一家庭住宅所作的決定將為最終決定，並對買方構成約束力；及
- (iii) 署長就什麼構成一個住宅單位所作的決定將為最終決定，並對買方構成約束力。」

(2) 公契及管理協議第 85 條規定：-

「管理人須在管理處備存一份由地政總署署長或任何其他不時替代其位的政府主管當局根據本公契附表三第 43 條所發出的同意的資料記錄，以供所有業主免費查閱及自費影印該資料記錄，並繳付合理費用。所有就此收取的費用一律撥入特別基金。」

(3) 公契及管理協議附表三第 43 條規定：-

「43. 除非事先獲得地政總署署長或任何其他不時替代其位的政府主管當局的書面同意，否則任何業主不得進行或允許或容忍他人進行任何與住宅單位相關而可導致該住宅單位內部相連及通往任何毗連或毗鄰的住宅單位的工程，包括但不限於拆卸或更改任何分隔牆或任何樓板或天台樓板或任何間隔結構。而地政總署署長具有全權酌情給予同意或拒絕同意，倘若給予同意，業主須遵從地政總署署長按其全權酌情附加的任何條款及條件（包括支付費用）。」

(4) 發展項目內所提供的住宅單位總數目為 590。

(5) 平面圖所列的數字為以毫米標示之建築結構尺寸。

(6) 因住宅物業的較高樓層的結構牆的厚度遞減，較高樓層的內部面積，一般比較低樓層的內部面積稍大。

(7) 請參閱本售樓說明書第 20 頁為住宅物業樓面平面圖而設之備註及名詞及簡稱的圖例。

Notes:

(1) Special Condition No. (8)(d) of the Land Grant stipulates that: -

“(d) the total number of residential units erected or to be erected on the lot shall not be less than 515, and for the purposes of this sub-clause (d):

- (i) a detached, semi-detached or terraced house which is intended for use as a single family residence shall be regarded as a residential unit;
- (ii) the decision of the Director as to whether a detached, semi-detached or terraced house constitutes or is intended for use as a single family residence shall be final and binding on the Purchaser; and
- (iii) the decision of the Director as to what constitutes a residential unit shall be final and binding on the Purchaser.”

(2) Clause 85 of the Deed of Mutual Covenant incorporating Management Agreement stipulates that: -

“85. The Manager shall deposit in the management office the record provided by the Director of Lands or any other Government authority in place of him from time to time of the information relating to the consent given under Clause 43 of the Third Schedule hereto for inspection by all Owners free of charge and taking copies at their own expense and on payment of a reasonable charge. All charges received shall be credited to the Special Fund.”

(3) Clause 43 of the Third Schedule to the Deed of Mutual Covenant incorporating Management Agreement stipulates that: -

“43. No Owner shall carry out or permit or suffer to be carried out any works in connection with any Residential Unit, including but not limited to demolition or alteration of any partition wall or any floor or roof slab or any partition structure, which will result in such Residential Unit being internally linked to and accessible from any adjoining or adjacent Residential Unit, except with the prior written consent of the Director of Lands or any other Government authority in place of him from time to time, which consent may be given or withheld at his absolute discretion and if given, may be subject to such terms and conditions (including payment of fees) as may be imposed by him at his absolute discretion.”

(4) The total number of residential units provided in the development is 590.

(5) The dimensions in floor plans are all structural dimensions in millimeter.

(6) The internal areas of the residential properties on the upper floors will generally be slightly larger than those on the lower floors because of the reducing thickness of the structural walls on the upper floors.

(7) Please refer to page 20 of this sales brochure for the remarks and legends of the terms and abbreviations for the floor plans of residential properties.

10 發展項目的住宅物業的樓面平面圖 FLOOR PLANS OF RESIDENTIAL PROPERTIES IN THE DEVELOPMENT

B5洋房 House B5

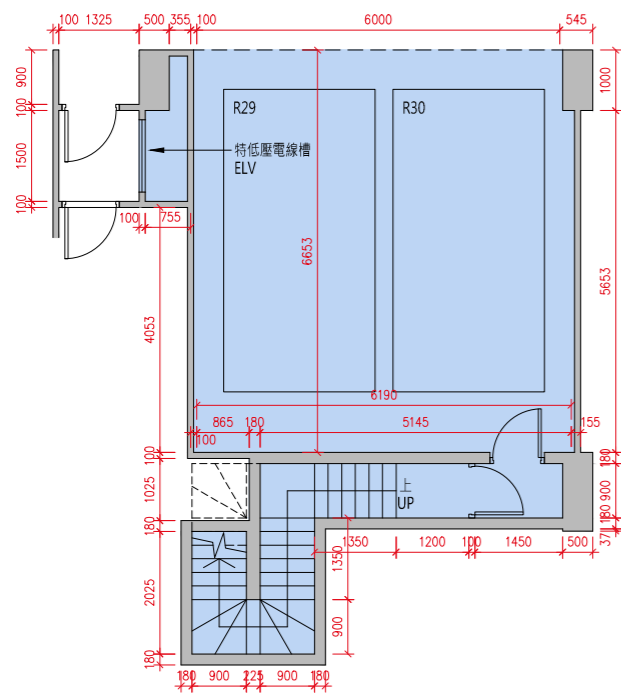

地庫1樓平面圖
B1/F Floor Plan

貼鄰住客停車位的面積 (不計算入停車位面積或實用面積) :
B5 洋房地庫 1 樓為 15.992 平方米 (172 平方呎)。
Area adjoining residential parking space (not included in the area of parking space or saleable area): House B5 on B1/F is 15.992 sq.m. 172sq.ft.)

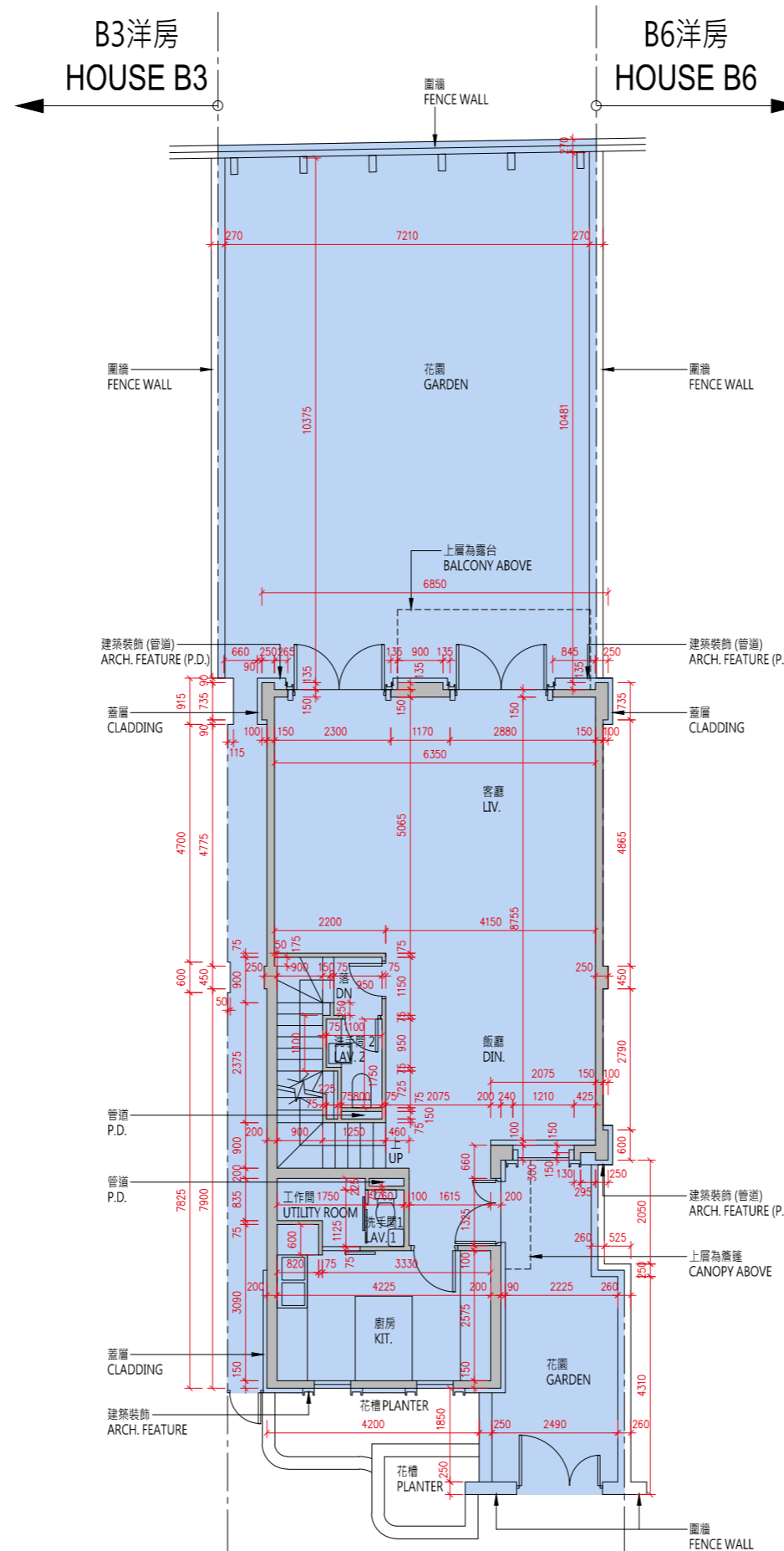

地下平面圖
G/F Floor Plan

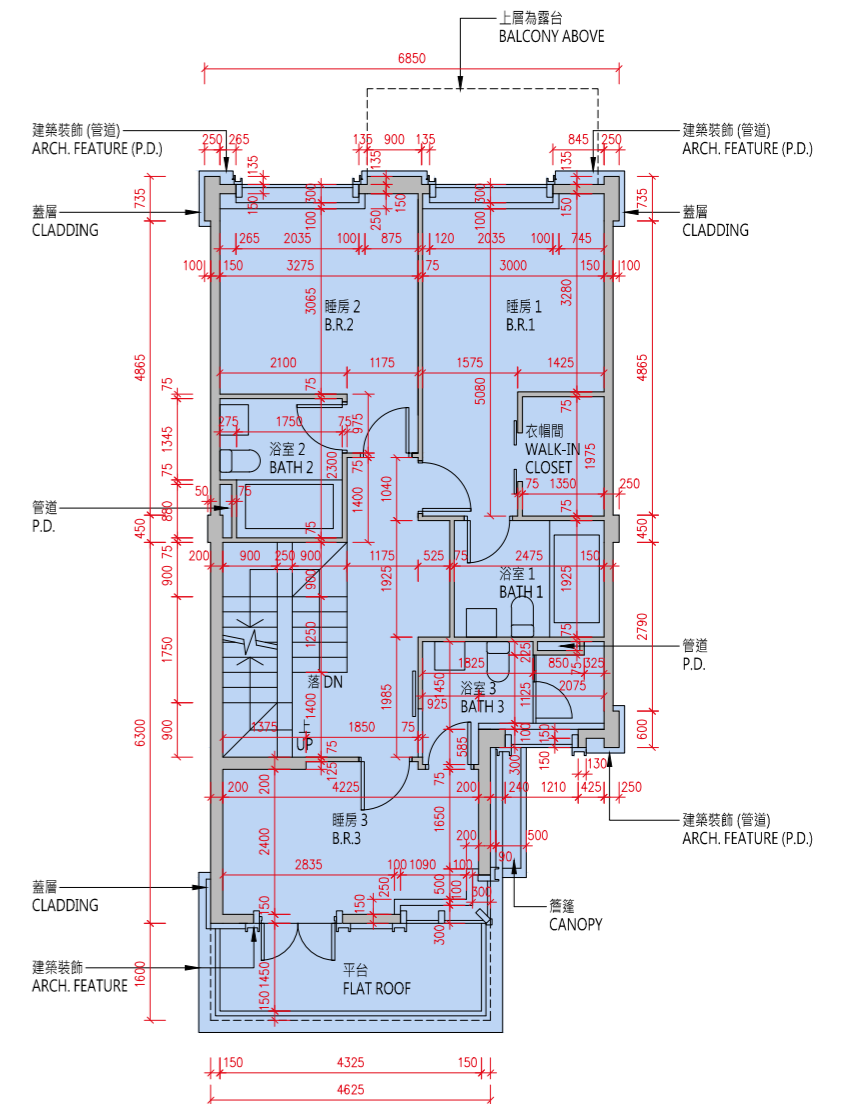

1樓平面圖
1/F Floor Plan

比例 : 0米/M 5米/M
Scale : 0 5米/M



B5洋房
House B5

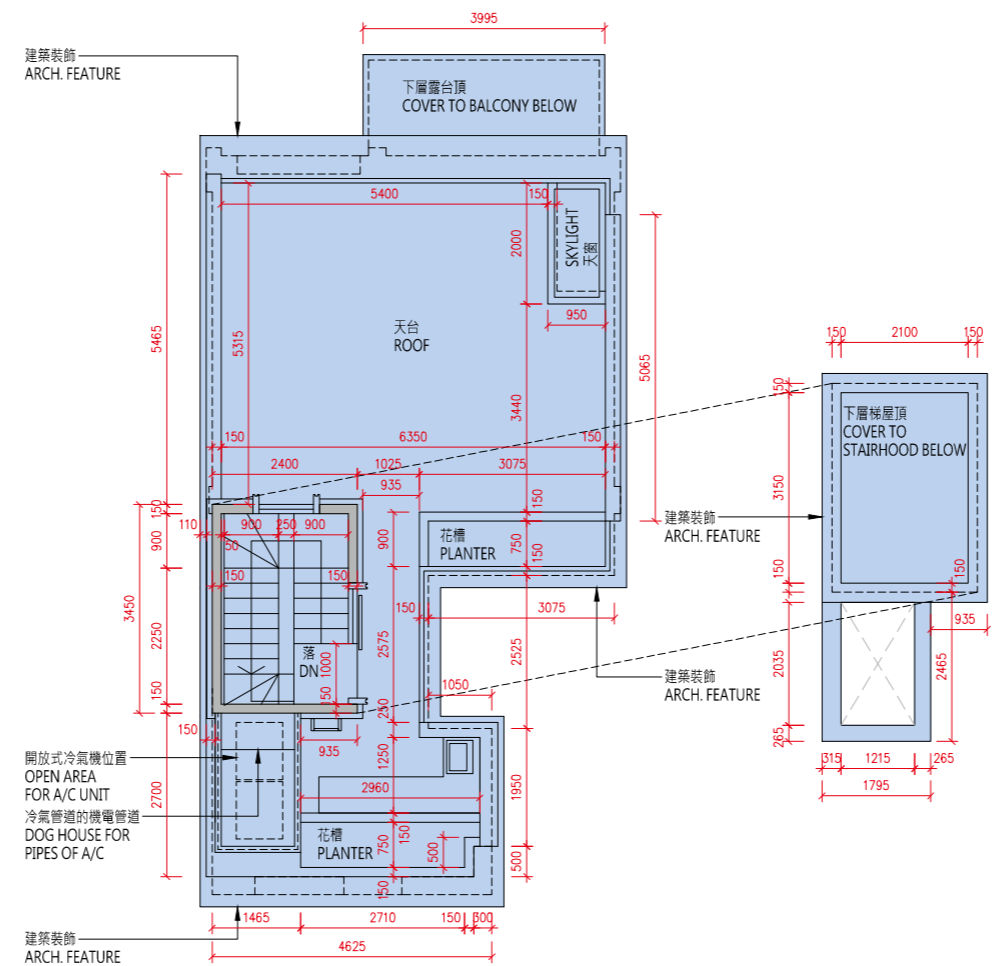
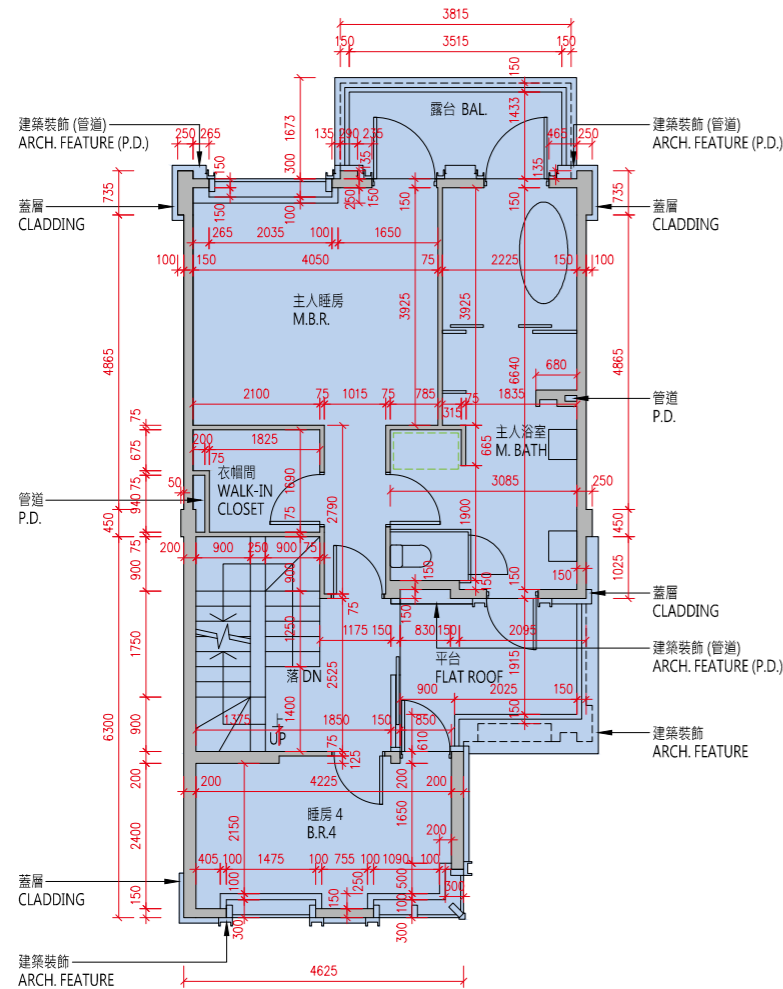

比例：0米/M 5米/M
Scale :

樓層 Floor	地庫1樓 B1/F	地下 G/F	1樓 1/F	2樓 2/F	天台 Roof
層與層之間的高度 (毫米) Floor to Floor Height (mm)	4350, 4950, 5060	3750, 3970, 4000	3050, 3080, 3125, 3300	3500	N/A
樓板 (不包括灰泥) 的厚度 (毫米) Thickness of Floor Slab (excluding plaster) (mm)	200	150, 200	150, 200	150, 200	N/A

10 發展項目的住宅物業的樓面平面圖

FLOOR PLANS OF RESIDENTIAL PROPERTIES IN THE DEVELOPMENT

備註：

- (1) 批地文件特別條件第 8(d) 條規定：-
「(d) 在該地段已建成或擬建的住宅單位數目須不少於 515，並就本 (d) 分條而言：
 - (i) 一座擬作為單一家庭住宅的獨立屋、半獨立屋或排屋均被視為一個住宅單位；
 - (ii) 署長就獨立屋、半獨立屋或排屋是否構成或擬作為單一家庭住宅所作的決定將為最終決定，並對買方構成約束力；及
 - (iii) 署長就什麼構成一個住宅單位所作的決定將為最終決定，並對買方構成約束力。」
- (2) 公契及管理協議第 85 條規定：-
「管理人須在管理處備存一份由地政總署署長或任何其他不時替代其位的政府主管當局根據本公契附表三第 43 條所發出的同意的資料記錄，以供所有業主免費查閱及自費影印該資料記錄，並繳付合理費用。所有就此收取的費用一律撥入特別基金。」
- (3) 公契及管理協議附表三第 43 條規定：-
「43. 除非事先獲得地政總署署長或任何其他不時替代其位的政府主管當局的書面同意，否則任何業主不得進行或允許或容忍他人進行任何與住宅單位相關而可導致該住宅單位內部相連及通往任何毗連或毗鄰的住宅單位的工程，包括但不限於拆卸或更改任何分隔牆或任何樓板或天台樓板或任何間隔結構。而地政總署署長具有全權酌情給予同意或拒絕同意，倘若給予同意，業主須遵從地政總署署長按其全權酌情附加的任何條款及條件（包括支付費用）。」
- (4) 發展項目內所提供的住宅單位總數目為 590。
- (5) 平面圖所列的數字為以毫米標示之建築結構尺寸。
- (6) 因住宅物業的較高樓層的結構牆的厚度遞減，較高樓層的內部面積，一般比較低樓層的內部面積稍大。
- (7) 請參閱本售樓說明書第 20 頁為住宅物業樓面平面圖而設之備註及名詞及簡稱的圖例。

Notes:

- (1) Special Condition No. (8)(d) of the Land Grant stipulates that: -
“(d) the total number of residential units erected or to be erected on the lot shall not be less than 515, and for the purposes of this sub-clause (d):
 - (i) a detached, semi-detached or terraced house which is intended for use as a single family residence shall be regarded as a residential unit;
 - (ii) the decision of the Director as to whether a detached, semi-detached or terraced house constitutes or is intended for use as a single family residence shall be final and binding on the Purchaser; and
 - (iii) the decision of the Director as to what constitutes a residential unit shall be final and binding on the Purchaser.”
- (2) Clause 85 of the Deed of Mutual Covenant incorporating Management Agreement stipulates that: -
“85. The Manager shall deposit in the management office the record provided by the Director of Lands or any other Government authority in place of him from time to time of the information relating to the consent given under Clause 43 of the Third Schedule hereto for inspection by all Owners free of charge and taking copies at their own expense and on payment of a reasonable charge. All charges received shall be credited to the Special Fund.”
- (3) Clause 43 of the Third Schedule to the Deed of Mutual Covenant incorporating Management Agreement stipulates that: -
“43. No Owner shall carry out or permit or suffer to be carried out any works in connection with any Residential Unit, including but not limited to demolition or alteration of any partition wall or any floor or roof slab or any partition structure, which will result in such Residential Unit being internally linked to and accessible from any adjoining or adjacent Residential Unit, except with the prior written consent of the Director of Lands or any other Government authority in place of him from time to time, which consent may be given or withheld at his absolute discretion and if given, may be subject to such terms and conditions (including payment of fees) as may be imposed by him at his absolute discretion.”
- (4) The total number of residential units provided in the development is 590.
- (5) The dimensions in floor plans are all structural dimensions in millimeter.
- (6) The internal areas of the residential properties on the upper floors will generally be slightly larger than those on the lower floors because of the reducing thickness of the structural walls on the upper floors.
- (7) Please refer to page 20 of this sales brochure for the remarks and legends of the terms and abbreviations for the floor plans of residential properties.

10 發展項目的住宅物業的樓面平面圖 FLOOR PLANS OF RESIDENTIAL PROPERTIES IN THE DEVELOPMENT

B6洋房 House B6

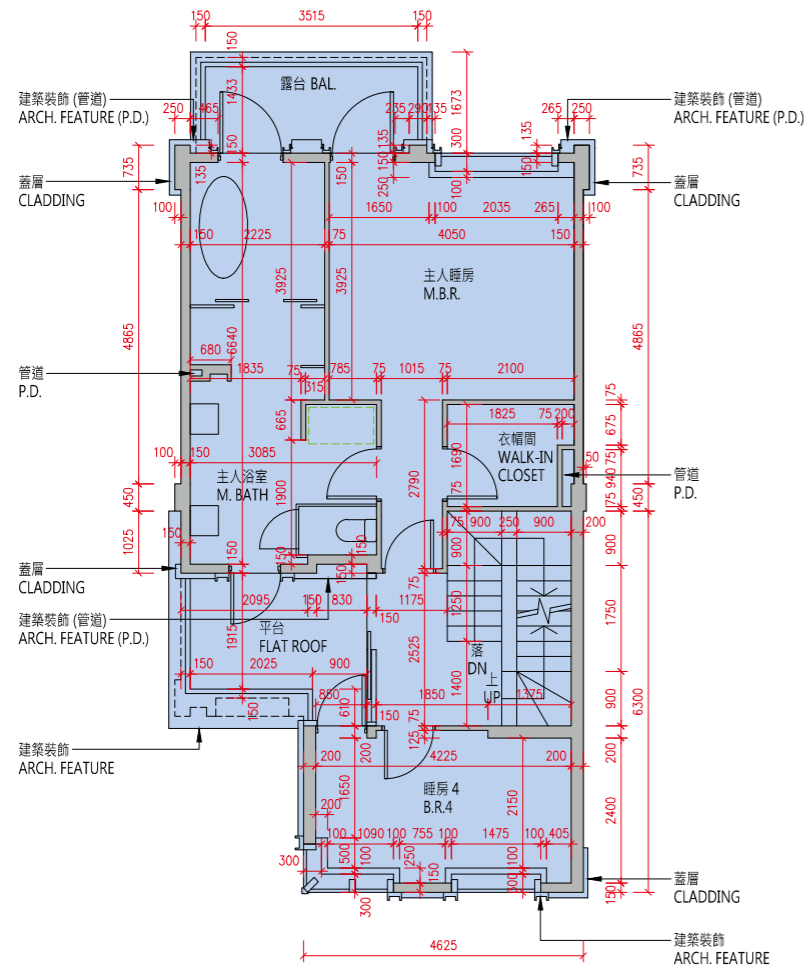

2樓平面圖
2/F Floor Plan

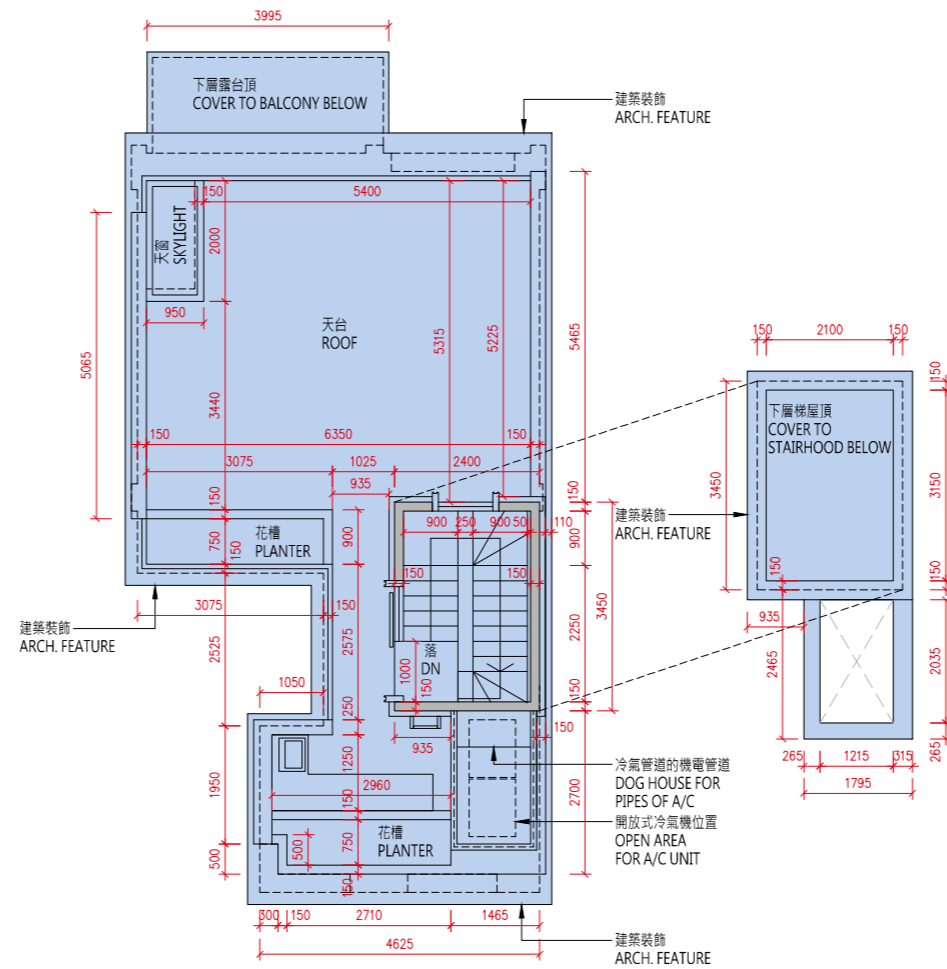

天台平面圖
Roof Floor Plan

比例：0米/M 5米/M
Scale :

樓層 Floor	地庫1樓 B1/F	地下 G/F	1樓 1/F	2樓 2/F	天台 Roof
層與層之間的高度 (毫米) Floor to Floor Height (mm)	4350, 4950, 5060	3750, 3970, 4000	3050, 3080, 3125, 3300	3500	N/A
樓板 (不包括灰泥) 的厚度 (毫米) Thickness of Floor Slab (excluding plaster) (mm)	200	150, 200	150, 200	150, 200	N/A

備註：

(1) 批地文件特別條件第 8(d) 條規定：-

「(d) 在該地段已建成或擬建的住宅單位數目須不少於 515，並就本 (d) 分條而言：

- (i) 一座擬作為單一家庭住宅的獨立屋、半獨立屋或排屋均被視為一個住宅單位；
- (ii) 署長就獨立屋、半獨立屋或排屋是否構成或擬作為單一家庭住宅所作的決定將為最終決定，並對買方構成約束力；及
- (iii) 署長就什麼構成一個住宅單位所作的決定將為最終決定，並對買方構成約束力。」

(2) 公契及管理協議第 85 條規定：-

「管理人須在管理處備存一份由地政總署署長或任何其他不時替代其位的政府主管當局根據本公契附表三第 43 條所發出的同意的資料記錄，以供所有業主免費查閱及自費影印該資料記錄，並繳付合理費用。所有就此收取的費用一律撥入特別基金。」

(3) 公契及管理協議附表三第 43 條規定：-

「43. 除非事先獲得地政總署署長或任何其他不時替代其位的政府主管當局的書面同意，否則任何業主不得進行或允許或容忍他人進行任何與住宅單位相關而可導致該住宅單位內部相連及通往任何毗連或毗鄰的住宅單位的工程，包括但不限於拆卸或更改任何分隔牆或任何樓板或天台樓板或任何間隔結構。而地政總署署長具有全權酌情給予同意或拒絕同意，倘若給予同意，業主須遵從地政總署署長按其全權酌情附加的任何條款及條件（包括支付費用）。」

(4) 發展項目內所提供的住宅單位總數目為 590。

(5) 平面圖所列的數字為以毫米標示之建築結構尺寸。

(6) 因住宅物業的較高樓層的結構牆的厚度遞減，較高樓層的內部面積，一般比較低樓層的內部面積稍大。

(7) 請參閱本售樓說明書第 20 頁為住宅物業樓面平面圖而設之備註及名詞及簡稱的圖例。

Notes:

(1) Special Condition No. (8)(d) of the Land Grant stipulates that: -

“(d) the total number of residential units erected or to be erected on the lot shall not be less than 515, and for the purposes of this sub-clause (d):

- (i) a detached, semi-detached or terraced house which is intended for use as a single family residence shall be regarded as a residential unit;
- (ii) the decision of the Director as to whether a detached, semi-detached or terraced house constitutes or is intended for use as a single family residence shall be final and binding on the Purchaser; and
- (iii) the decision of the Director as to what constitutes a residential unit shall be final and binding on the Purchaser.”

(2) Clause 85 of the Deed of Mutual Covenant incorporating Management Agreement stipulates that: -

“85. The Manager shall deposit in the management office the record provided by the Director of Lands or any other Government authority in place of him from time to time of the information relating to the consent given under Clause 43 of the Third Schedule hereto for inspection by all Owners free of charge and taking copies at their own expense and on payment of a reasonable charge. All charges received shall be credited to the Special Fund.”

(3) Clause 43 of the Third Schedule to the Deed of Mutual Covenant incorporating Management Agreement stipulates that: -

“43. No Owner shall carry out or permit or suffer to be carried out any works in connection with any Residential Unit, including but not limited to demolition or alteration of any partition wall or any floor or roof slab or any partition structure, which will result in such Residential Unit being internally linked to and accessible from any adjoining or adjacent Residential Unit, except with the prior written consent of the Director of Lands or any other Government authority in place of him from time to time, which consent may be given or withheld at his absolute discretion and if given, may be subject to such terms and conditions (including payment of fees) as may be imposed by him at his absolute discretion.”

(4) The total number of residential units provided in the development is 590.

(5) The dimensions in floor plans are all structural dimensions in millimeter.

(6) The internal areas of the residential properties on the upper floors will generally be slightly larger than those on the lower floors because of the reducing thickness of the structural walls on the upper floors.

(7) Please refer to page 20 of this sales brochure for the remarks and legends of the terms and abbreviations for the floor plans of residential properties.

B7洋房
House B7

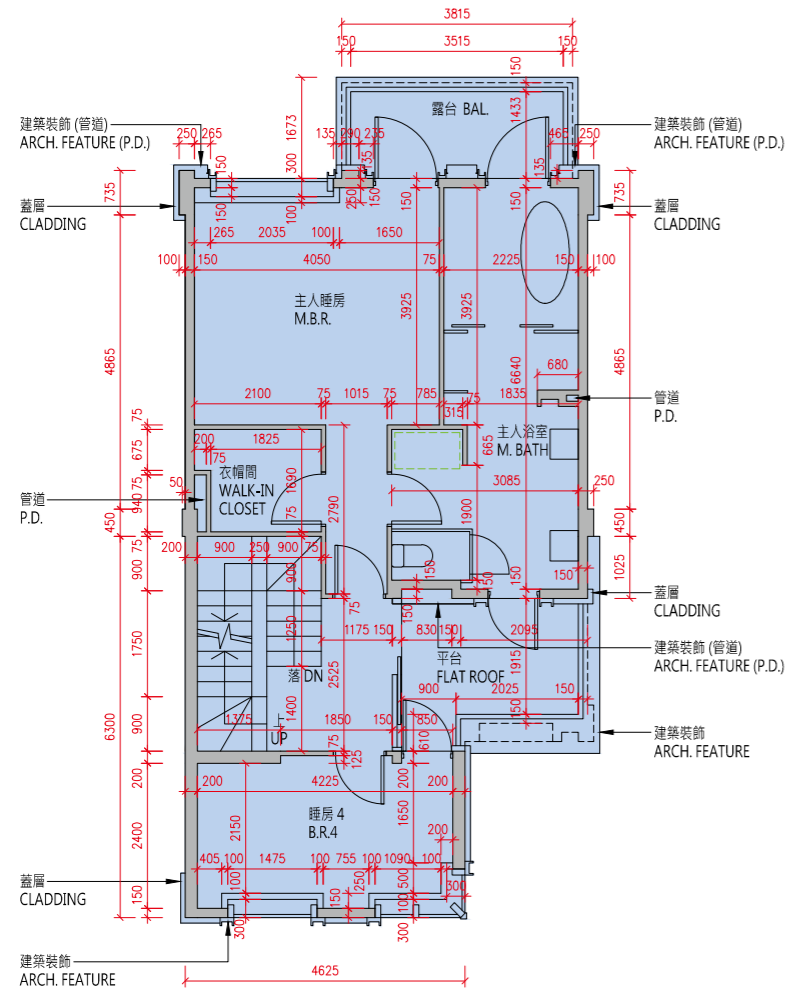

2樓平面圖
2/F Floor Plan

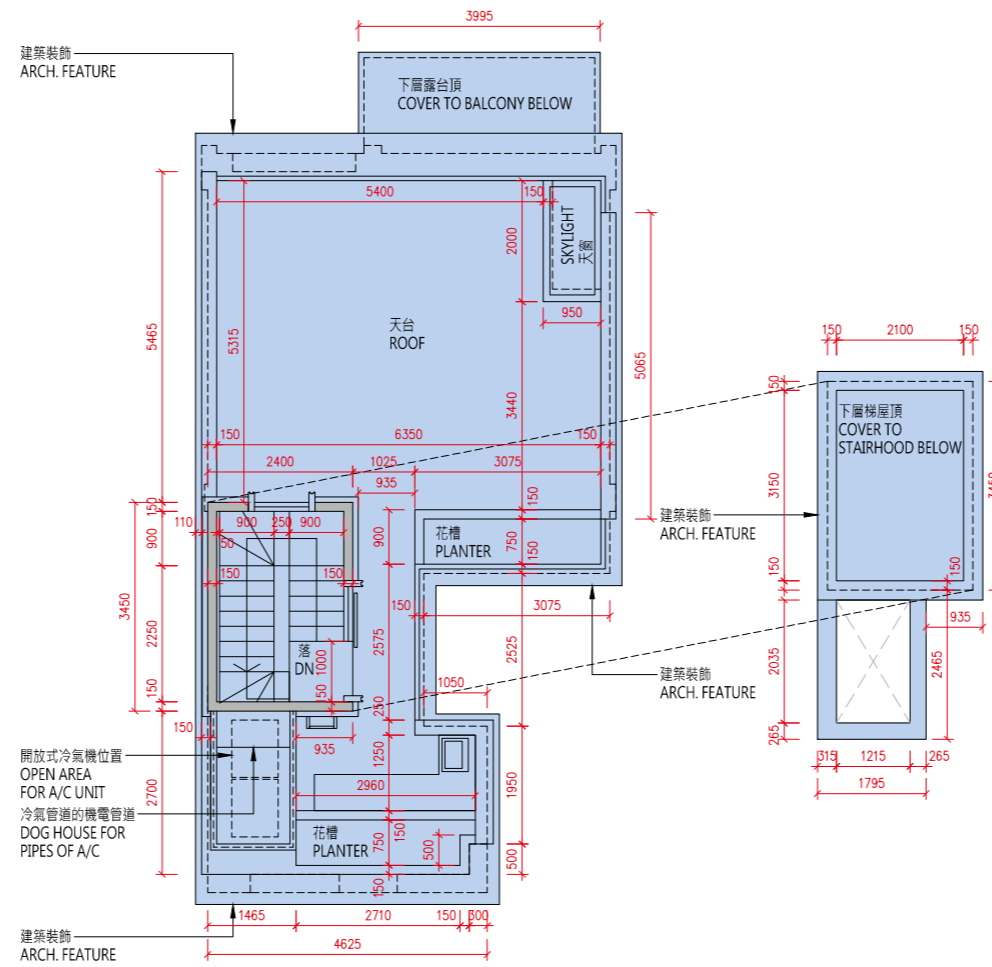

天台平面圖
Roof Floor Plan

比例：0米/M 5米/M
Scale : 0 5 10 15 20 25 30 35 40 45 50

樓層 Floor	地庫1樓 B1/F	地下 G/F	1樓 1/F	2樓 2/F	天台 Roof
層與層之間的高度 (毫米) Floor to Floor Height (mm)	4350, 4500, 4950	3750, 3970, 4000	3050, 3080, 3125, 3300	3500	N/A
樓板 (不包括灰泥) 的厚度 (毫米) Thickness of Floor Slab (excluding plaster) (mm)	200	150, 200	150, 200	150, 200	N/A

10 發展項目的住宅物業的樓面平面圖

FLOOR PLANS OF RESIDENTIAL PROPERTIES IN THE DEVELOPMENT

備註：

- (1) 批地文件特別條件第 8(d) 條規定：-
「(d) 在該地段已建成或擬建的住宅單位數目須不少於 515，並就本 (d) 分條而言：
 - (i) 一座擬作為單一家庭住宅的獨立屋、半獨立屋或排屋均被視為一個住宅單位；
 - (ii) 署長就獨立屋、半獨立屋或排屋是否構成或擬作為單一家庭住宅所作的決定將為最終決定，並對買方構成約束力；及
 - (iii) 署長就什麼構成一個住宅單位所作的決定將為最終決定，並對買方構成約束力。」
- (2) 公契及管理協議第 85 條規定：-
「管理人須在管理處備存一份由地政總署署長或任何其他不時替代其位的政府主管當局根據本公契附表三第 43 條所發出的同意的資料記錄，以供所有業主免費查閱及自費影印該資料記錄，並繳付合理費用。所有就此收取的費用一律撥入特別基金。」
- (3) 公契及管理協議附表三第 43 條規定：-
「43. 除非事先獲得地政總署署長或任何其他不時替代其位的政府主管當局的書面同意，否則任何業主不得進行或允許或容忍他人進行任何與住宅單位相關而可導致該住宅單位內部相連及通往任何毗連或毗鄰的住宅單位的工程，包括但不限於拆卸或更改任何分隔牆或任何樓板或天台樓板或任何間隔結構。而地政總署署長具有全權酌情給予同意或拒絕同意，倘若給予同意，業主須遵從地政總署署長按其全權酌情附加的任何條款及條件（包括支付費用）。」
- (4) 發展項目內所提供的住宅單位總數目為 590。
- (5) 平面圖所列的數字為以毫米標示之建築結構尺寸。
- (6) 因住宅物業的較高樓層的結構牆的厚度遞減，較高樓層的內部面積，一般比較低樓層的內部面積稍大。
- (7) 請參閱本售樓說明書第 20 頁為住宅物業樓面平面圖而設之備註及名詞及簡稱的圖例。

Notes:

- (1) Special Condition No. (8)(d) of the Land Grant stipulates that: -
“(d) the total number of residential units erected or to be erected on the lot shall not be less than 515, and for the purposes of this sub-clause (d):
 - (i) a detached, semi-detached or terraced house which is intended for use as a single family residence shall be regarded as a residential unit;
 - (ii) the decision of the Director as to whether a detached, semi-detached or terraced house constitutes or is intended for use as a single family residence shall be final and binding on the Purchaser; and
 - (iii) the decision of the Director as to what constitutes a residential unit shall be final and binding on the Purchaser.”
- (2) Clause 85 of the Deed of Mutual Covenant incorporating Management Agreement stipulates that: -
“85. The Manager shall deposit in the management office the record provided by the Director of Lands or any other Government authority in place of him from time to time of the information relating to the consent given under Clause 43 of the Third Schedule hereto for inspection by all Owners free of charge and taking copies at their own expense and on payment of a reasonable charge. All charges received shall be credited to the Special Fund.”
- (3) Clause 43 of the Third Schedule to the Deed of Mutual Covenant incorporating Management Agreement stipulates that: -
“43. No Owner shall carry out or permit or suffer to be carried out any works in connection with any Residential Unit, including but not limited to demolition or alteration of any partition wall or any floor or roof slab or any partition structure, which will result in such Residential Unit being internally linked to and accessible from any adjoining or adjacent Residential Unit, except with the prior written consent of the Director of Lands or any other Government authority in place of him from time to time, which consent may be given or withheld at his absolute discretion and if given, may be subject to such terms and conditions (including payment of fees) as may be imposed by him at his absolute discretion.”
- (4) The total number of residential units provided in the development is 590.
- (5) The dimensions in floor plans are all structural dimensions in millimeter.
- (6) The internal areas of the residential properties on the upper floors will generally be slightly larger than those on the lower floors because of the reducing thickness of the structural walls on the upper floors.
- (7) Please refer to page 20 of this sales brochure for the remarks and legends of the terms and abbreviations for the floor plans of residential properties.

B8洋房
House B8

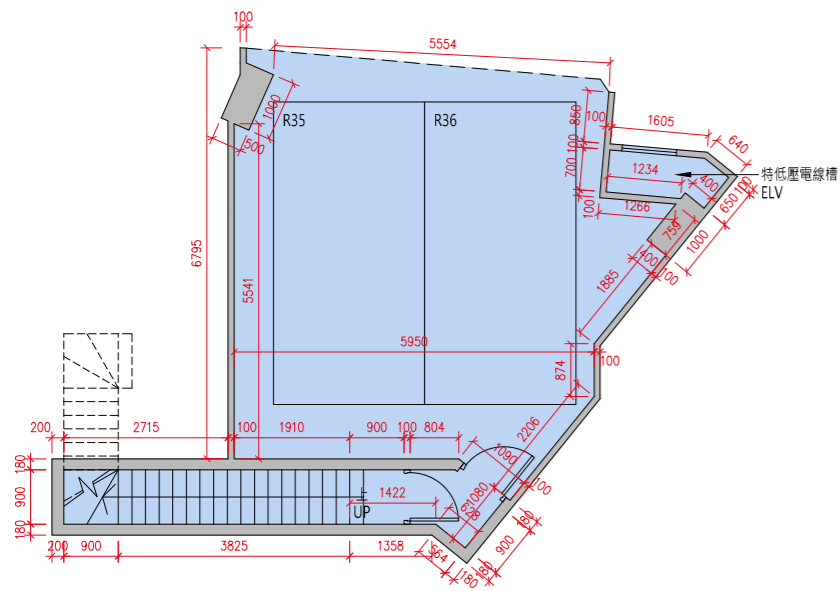

地庫1樓平面圖
B1/F Floor Plan

貼鄰住客停車位的面積 (不計算入停車位面積或實用面積) :
B8 洋房地庫 1 樓為 15.672 平方米 (169 平方呎)。
Area adjoining residential parking space (not included in the area of parking space or saleable area): House B8 on B1/F is 15.672sq.m. (169sq.ft.)

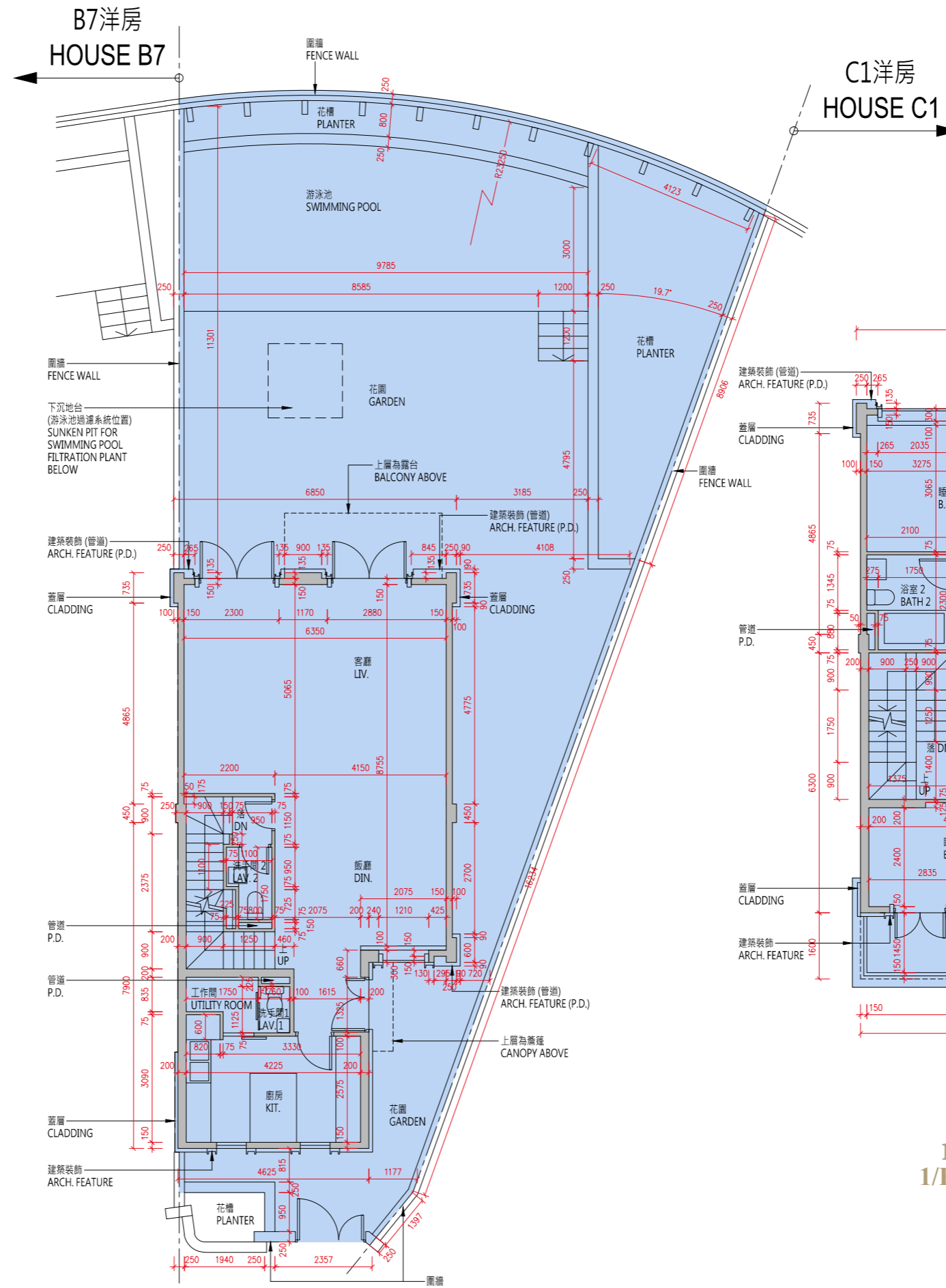

地下平面圖
G/F Floor Plan

C1洋房
HOUSE C1

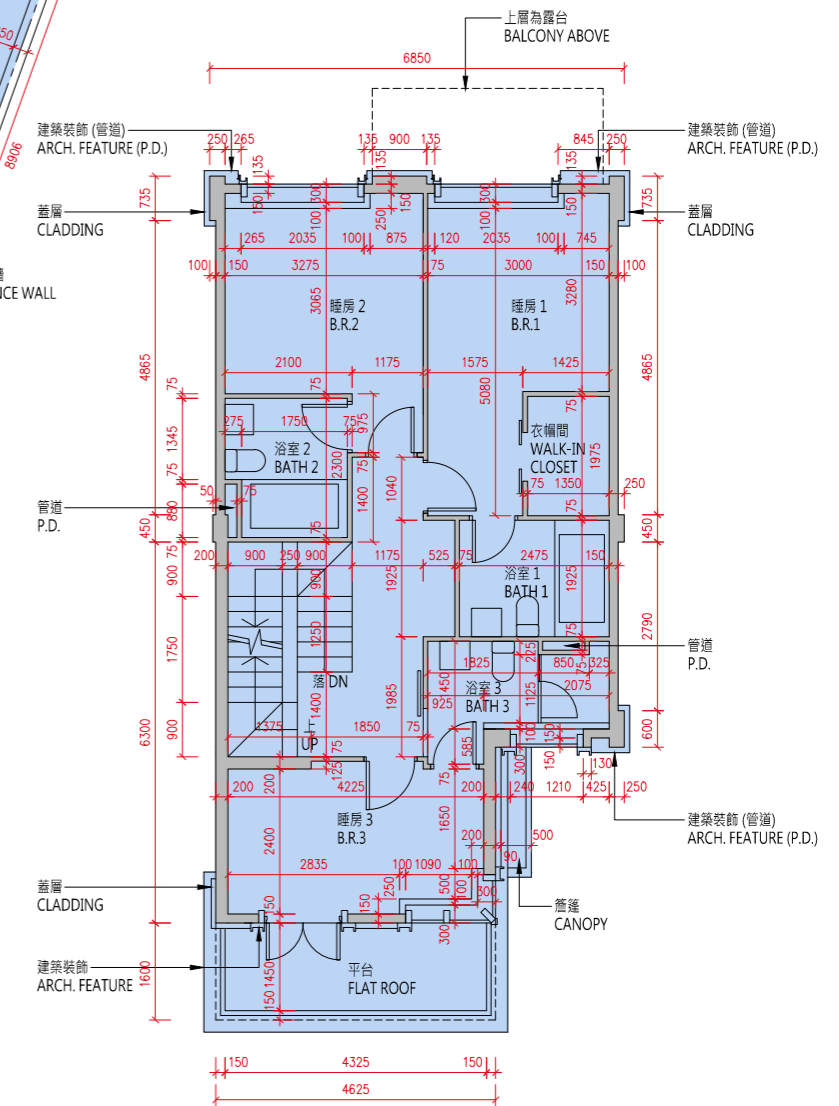

1樓平面圖
1/F Floor Plan

比例 : 0米/M 5米/M
Scale : 5米/M

10 發展項目的住宅物業的樓面平面圖 FLOOR PLANS OF RESIDENTIAL PROPERTIES IN THE DEVELOPMENT

B8洋房 House B8

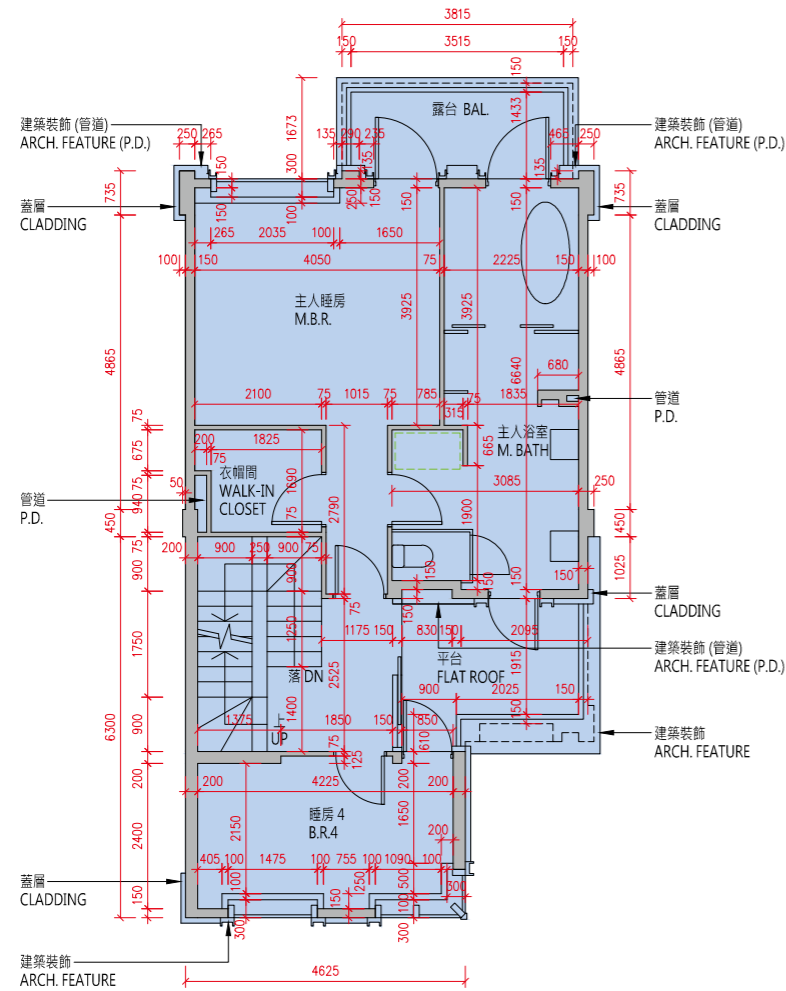

2樓平面圖
2/F Floor Plan

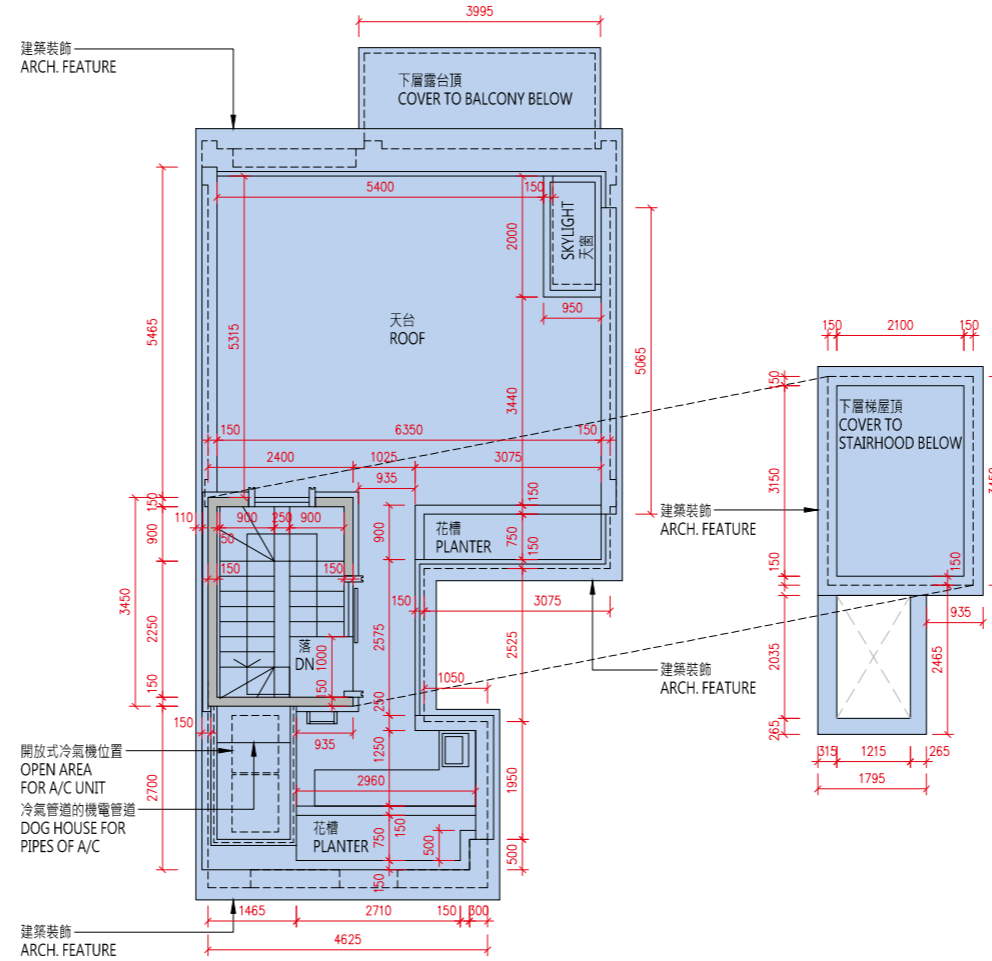

天台平面圖
Roof Floor Plan

比例：0米/M 5米/M
Scale :

樓層 Floor	地庫1樓 B1/F	地下 G/F	1樓 1/F	2樓 2/F	天台 Roof
層與層之間的高度 (毫米) Floor to Floor Height (mm)	4350, 4500, 4650	3750, 3970, 4000	3050, 3080, 3125, 3300	3500	N/A
樓板 (不包括灰泥) 的厚度 (毫米) Thickness of Floor Slab (excluding plaster) (mm)	200	150, 200	150, 200	150, 200	N/A

備註：

(1) 批地文件特別條件第 8(d) 條規定：-

「(d) 在該地段已建成或擬建的住宅單位數目須不少於 515，並就本 (d) 分條而言：

- (i) 一座擬作為單一家庭住宅的獨立屋、半獨立屋或排屋均被視為一個住宅單位；
- (ii) 署長就獨立屋、半獨立屋或排屋是否構成或擬作為單一家庭住宅所作的決定將為最終決定，並對買方構成約束力；及
- (iii) 署長就什麼構成一個住宅單位所作的決定將為最終決定，並對買方構成約束力。」

(2) 公契及管理協議第 85 條規定：-

「管理人須在管理處備存一份由地政總署署長或任何其他不時替代其位的政府主管當局根據本公契附表三第 43 條所發出的同意的資料記錄，以供所有業主免費查閱及自費影印該資料記錄，並繳付合理費用。所有就此收取的費用一律撥入特別基金。」

(3) 公契及管理協議附表三第 43 條規定：-

「43. 除非事先獲得地政總署署長或任何其他不時替代其位的政府主管當局的書面同意，否則任何業主不得進行或允許或容忍他人進行任何與住宅單位相關而可導致該住宅單位內部相連及通往任何毗連或毗鄰的住宅單位的工程，包括但不限於拆卸或更改任何分隔牆或任何樓板或天台樓板或任何間隔結構。而地政總署署長具有全權酌情給予同意或拒絕同意，倘若給予同意，業主須遵從地政總署署長按其全權酌情附加的任何條款及條件（包括支付費用）。」

(4) 發展項目內所提供的住宅單位總數目為 590。

(5) 平面圖所列的數字為以毫米標示之建築結構尺寸。

(6) 因住宅物業的較高樓層的結構牆的厚度遞減，較高樓層的內部面積，一般比較低樓層的內部面積稍大。

(7) 請參閱本售樓說明書第 20 頁為住宅物業樓面平面圖而設之備註及名詞及簡稱的圖例。

Notes:

(1) Special Condition No. (8)(d) of the Land Grant stipulates that: -

“(d) the total number of residential units erected or to be erected on the lot shall not be less than 515, and for the purposes of this sub-clause (d):

- (i) a detached, semi-detached or terraced house which is intended for use as a single family residence shall be regarded as a residential unit;
- (ii) the decision of the Director as to whether a detached, semi-detached or terraced house constitutes or is intended for use as a single family residence shall be final and binding on the Purchaser; and
- (iii) the decision of the Director as to what constitutes a residential unit shall be final and binding on the Purchaser.”

(2) Clause 85 of the Deed of Mutual Covenant incorporating Management Agreement stipulates that: -

“85. The Manager shall deposit in the management office the record provided by the Director of Lands or any other Government authority in place of him from time to time of the information relating to the consent given under Clause 43 of the Third Schedule hereto for inspection by all Owners free of charge and taking copies at their own expense and on payment of a reasonable charge. All charges received shall be credited to the Special Fund.”

(3) Clause 43 of the Third Schedule to the Deed of Mutual Covenant incorporating Management Agreement stipulates that: -

“43. No Owner shall carry out or permit or suffer to be carried out any works in connection with any Residential Unit, including but not limited to demolition or alteration of any partition wall or any floor or roof slab or any partition structure, which will result in such Residential Unit being internally linked to and accessible from any adjoining or adjacent Residential Unit, except with the prior written consent of the Director of Lands or any other Government authority in place of him from time to time, which consent may be given or withheld at his absolute discretion and if given, may be subject to such terms and conditions (including payment of fees) as may be imposed by him at his absolute discretion.”

(4) The total number of residential units provided in the development is 590.

(5) The dimensions in floor plans are all structural dimensions in millimeter.

(6) The internal areas of the residential properties on the upper floors will generally be slightly larger than those on the lower floors because of the reducing thickness of the structural walls on the upper floors.

(7) Please refer to page 20 of this sales brochure for the remarks and legends of the terms and abbreviations for the floor plans of residential properties.

10 發展項目的住宅物業的樓面平面圖 FLOOR PLANS OF RESIDENTIAL PROPERTIES IN THE DEVELOPMENT

C1洋房
House C1

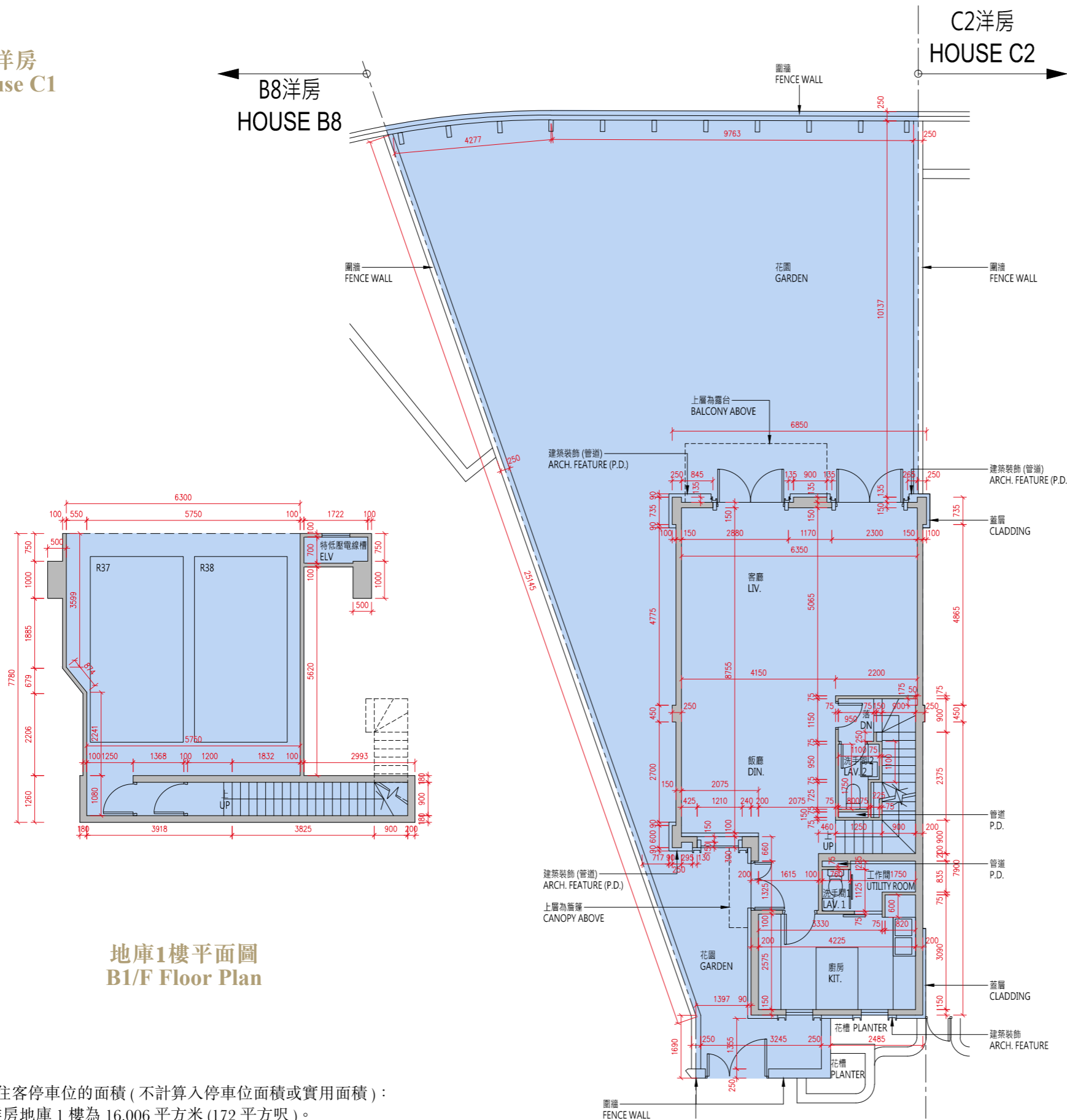

地庫1樓平面圖
B1/F Floor Plan

地下平面圖
G/F Floor Plan

貼鄰住客停車位的面積 (不計算入停車位面積或實用面積) :
C1 洋房地庫 1 樓為 16.006 平方米 (172 平方呎)。
Area adjoining residential parking space (not included in the area of parking space or saleable area): House C1 on B1/F is 16.006 sq.m. (172sq.ft.)

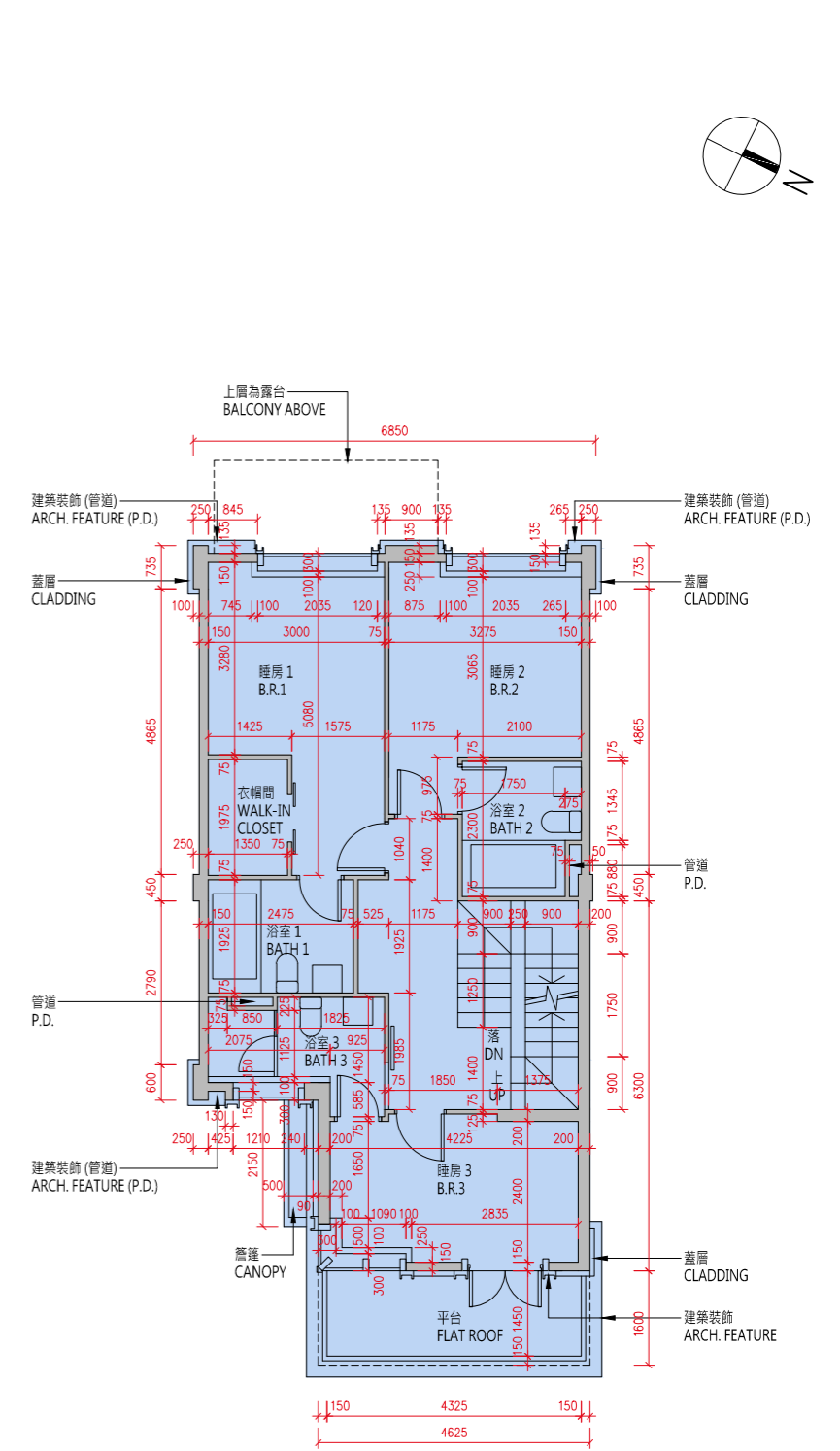

1樓平面圖
1/F Floor Plan

比例 : 0米/M 5米/M
Scale :

C1洋房
House C1

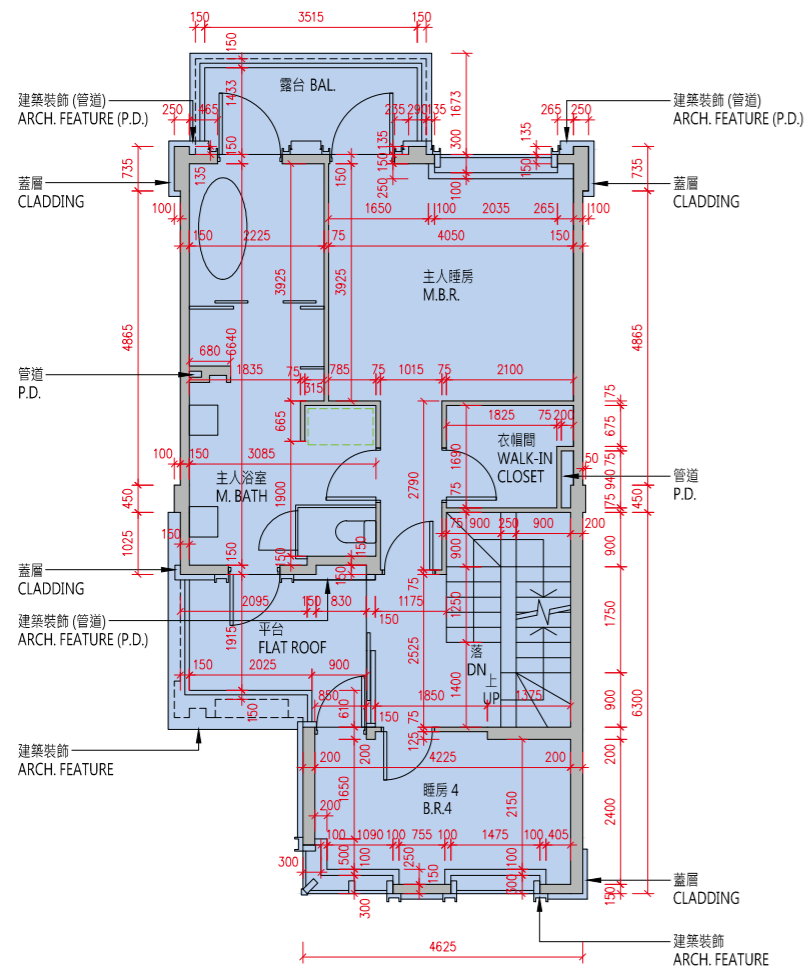
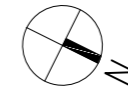

2樓平面圖
2/F Floor Plan

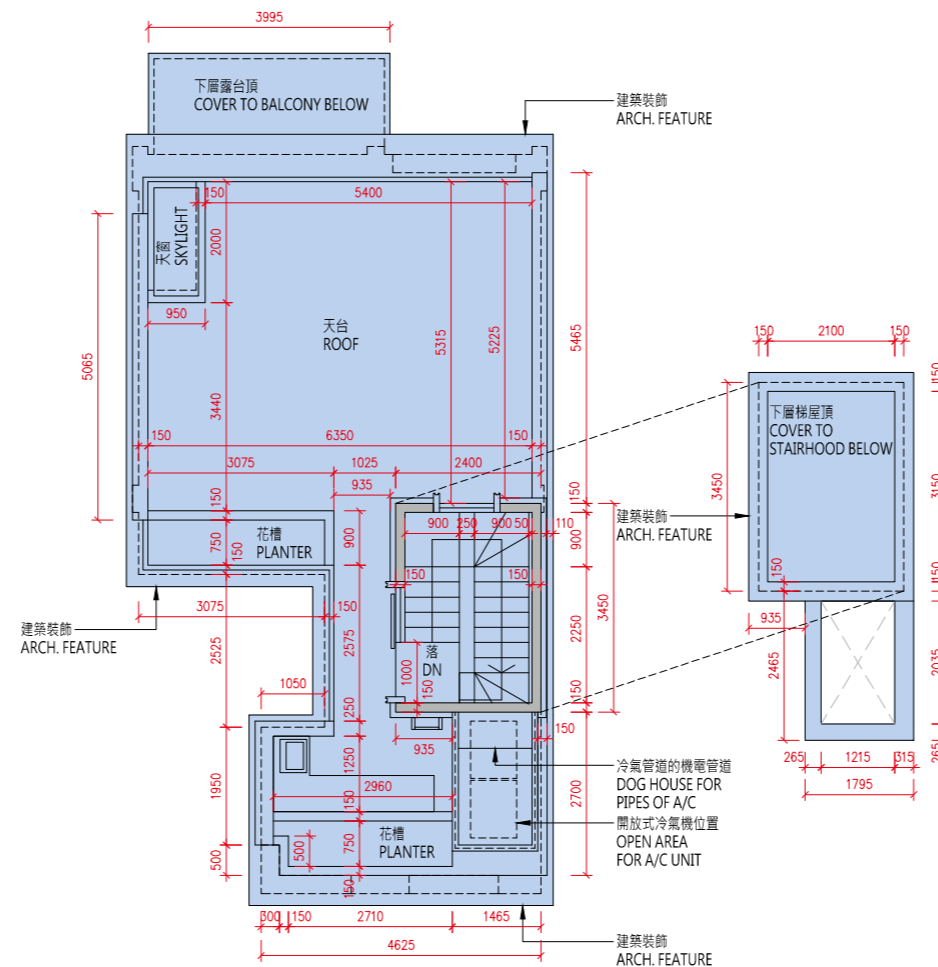

天台平面圖
Roof Floor Plan

比例：0米/M 5米/M
Scale :

樓層 Floor	地庫1樓 B1/F	地下 G/F	1樓 1/F	2樓 2/F	天台 Roof
層與層之間的高度 (毫米) Floor to Floor Height (mm)	4350, 4500, 4950	3750, 3970, 4000	3050, 3080, 3125, 3300	3500	N/A
樓板 (不包括灰泥) 的厚度 (毫米) Thickness of Floor Slab (excluding plaster) (mm)	200	150, 200	150, 200	150, 200	N/A

10 發展項目的住宅物業的樓面平面圖

FLOOR PLANS OF RESIDENTIAL PROPERTIES IN THE DEVELOPMENT

備註：

- (1) 批地文件特別條件第 8(d) 條規定：-
「(d) 在該地段已建成或擬建的住宅單位數目須不少於 515，並就本 (d) 分條而言：
 - (i) 一座擬作為單一家庭住宅的獨立屋、半獨立屋或排屋均被視為一個住宅單位；
 - (ii) 署長就獨立屋、半獨立屋或排屋是否構成或擬作為單一家庭住宅所作的決定將為最終決定，並對買方構成約束力；及
 - (iii) 署長就什麼構成一個住宅單位所作的決定將為最終決定，並對買方構成約束力。」
- (2) 公契及管理協議第 85 條規定：-
「管理人須在管理處備存一份由地政總署署長或任何其他不時替代其位的政府主管當局根據本公契附表三第 43 條所發出的同意的資料記錄，以供所有業主免費查閱及自費影印該資料記錄，並繳付合理費用。所有就此收取的費用一律撥入特別基金。」
- (3) 公契及管理協議附表三第 43 條規定：-
「43. 除非事先獲得地政總署署長或任何其他不時替代其位的政府主管當局的書面同意，否則任何業主不得進行或允許或容忍他人進行任何與住宅單位相關而可導致該住宅單位內部相連及通往任何毗連或毗鄰的住宅單位的工程，包括但不限於拆卸或更改任何分隔牆或任何樓板或天台樓板或任何間隔結構。而地政總署署長具有全權酌情給予同意或拒絕同意，倘若給予同意，業主須遵從地政總署署長按其全權酌情附加的任何條款及條件（包括支付費用）。」
- (4) 發展項目內所提供的住宅單位總數目為 590。
- (5) 平面圖所列的數字為以毫米標示之建築結構尺寸。
- (6) 因住宅物業的較高樓層的結構牆的厚度遞減，較高樓層的內部面積，一般比較低樓層的內部面積稍大。
- (7) 請參閱本售樓說明書第 20 頁為住宅物業樓面平面圖而設之備註及名詞及簡稱的圖例。

Notes:

- (1) Special Condition No. (8)(d) of the Land Grant stipulates that: -
“(d) the total number of residential units erected or to be erected on the lot shall not be less than 515, and for the purposes of this sub-clause (d):
 - (i) a detached, semi-detached or terraced house which is intended for use as a single family residence shall be regarded as a residential unit;
 - (ii) the decision of the Director as to whether a detached, semi-detached or terraced house constitutes or is intended for use as a single family residence shall be final and binding on the Purchaser; and
 - (iii) the decision of the Director as to what constitutes a residential unit shall be final and binding on the Purchaser.”
- (2) Clause 85 of the Deed of Mutual Covenant incorporating Management Agreement stipulates that: -
“85. The Manager shall deposit in the management office the record provided by the Director of Lands or any other Government authority in place of him from time to time of the information relating to the consent given under Clause 43 of the Third Schedule hereto for inspection by all Owners free of charge and taking copies at their own expense and on payment of a reasonable charge. All charges received shall be credited to the Special Fund.”
- (3) Clause 43 of the Third Schedule to the Deed of Mutual Covenant incorporating Management Agreement stipulates that: -
“43. No Owner shall carry out or permit or suffer to be carried out any works in connection with any Residential Unit, including but not limited to demolition or alteration of any partition wall or any floor or roof slab or any partition structure, which will result in such Residential Unit being internally linked to and accessible from any adjoining or adjacent Residential Unit, except with the prior written consent of the Director of Lands or any other Government authority in place of him from time to time, which consent may be given or withheld at his absolute discretion and if given, may be subject to such terms and conditions (including payment of fees) as may be imposed by him at his absolute discretion.”
- (4) The total number of residential units provided in the development is 590.
- (5) The dimensions in floor plans are all structural dimensions in millimeter.
- (6) The internal areas of the residential properties on the upper floors will generally be slightly larger than those on the lower floors because of the reducing thickness of the structural walls on the upper floors.
- (7) Please refer to page 20 of this sales brochure for the remarks and legends of the terms and abbreviations for the floor plans of residential properties.

C2洋房
House C2

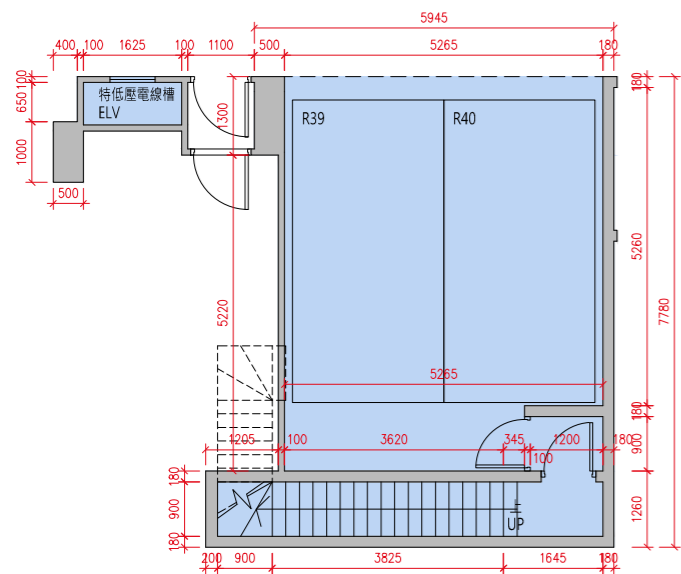

地庫1樓平面圖
B1/F Floor Plan

貼鄰住客停車位的面積 (不計算入停車位面積或實用面積) :
C2 洋房地庫 1 樓為 7.924 平方米 (85 平方呎)。
Area adjoining residential parking space (not included in the area of parking space or saleable area): House C2 on B1/F is 7.924 sq.m. (85sq.ft.)

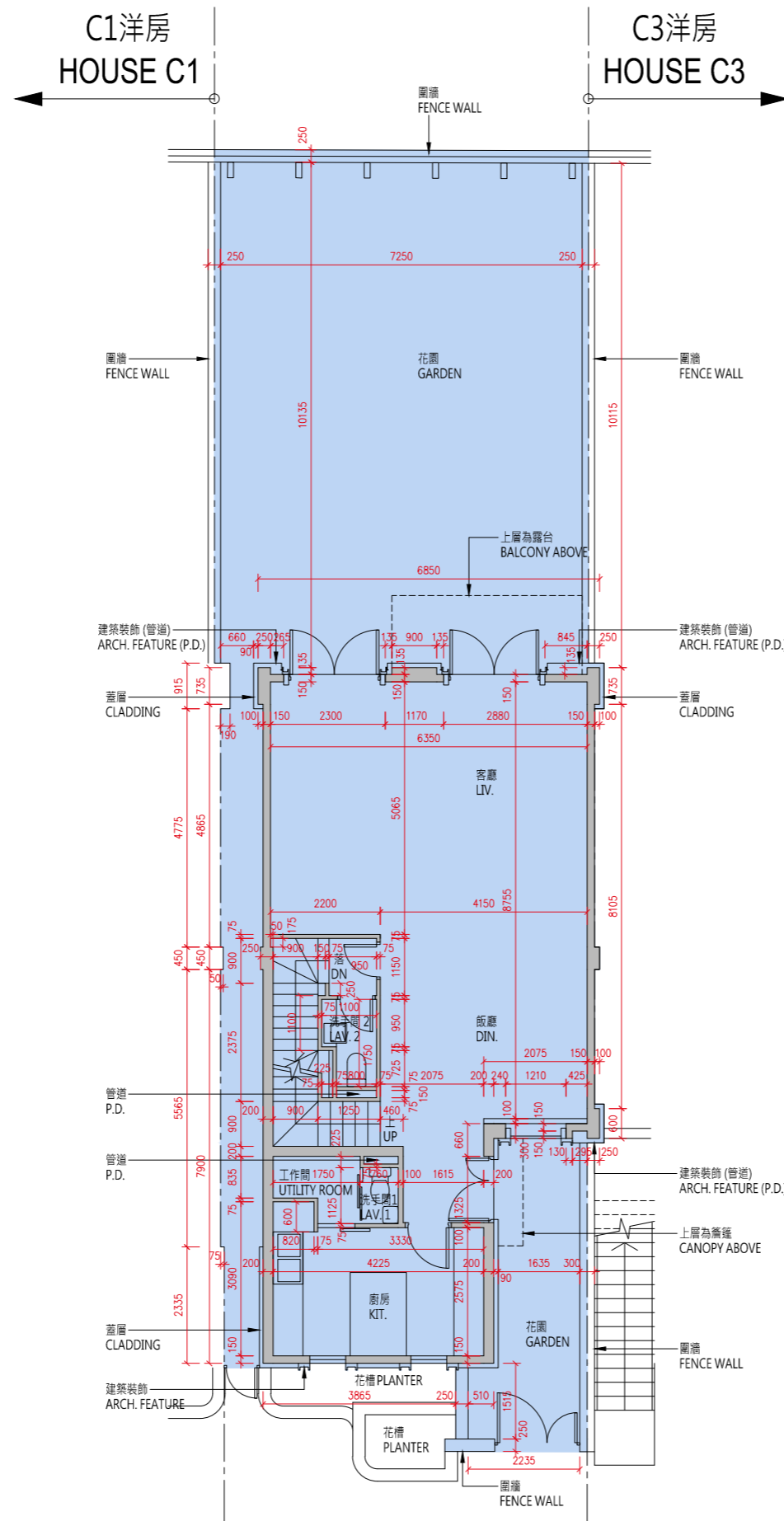

地下平面圖
G/F Floor Plan

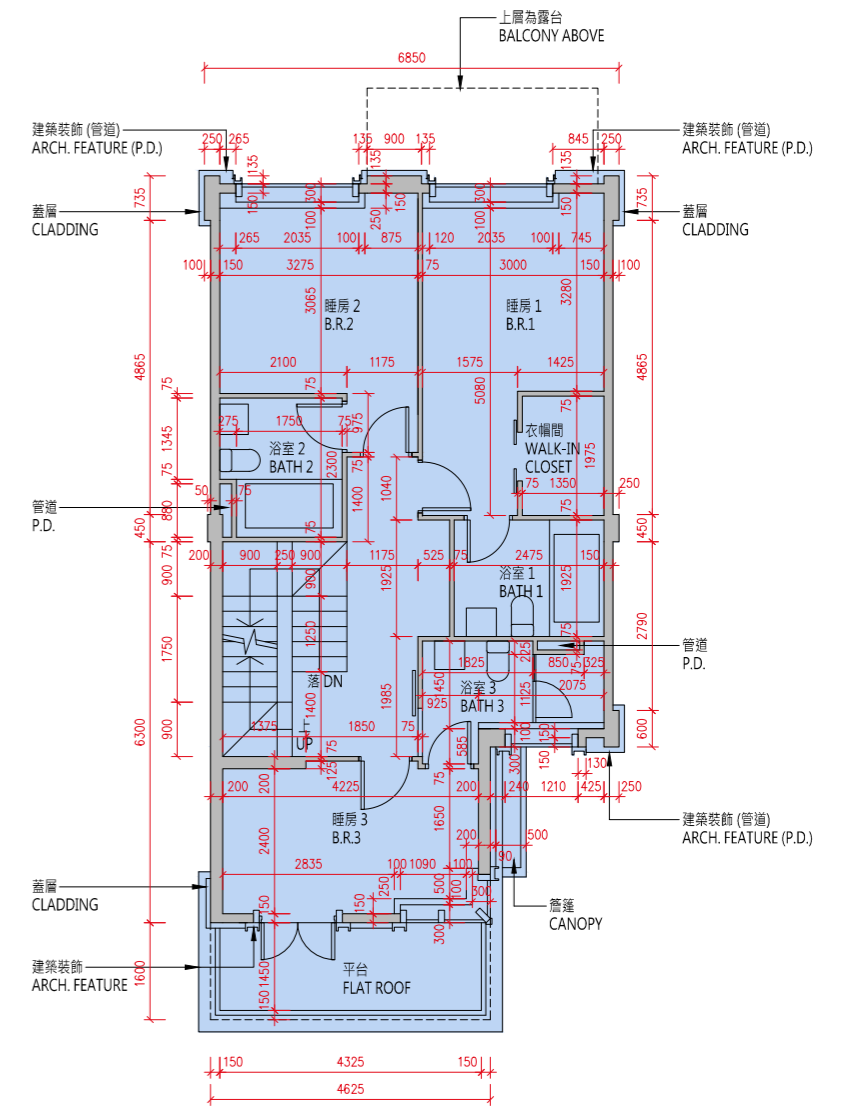

1樓平面圖
1/F Floor Plan

比例 : 0米/M 5米/M
Scale :

10 發展項目的住宅物業的樓面平面圖 FLOOR PLANS OF RESIDENTIAL PROPERTIES IN THE DEVELOPMENT

C2洋房 House C2

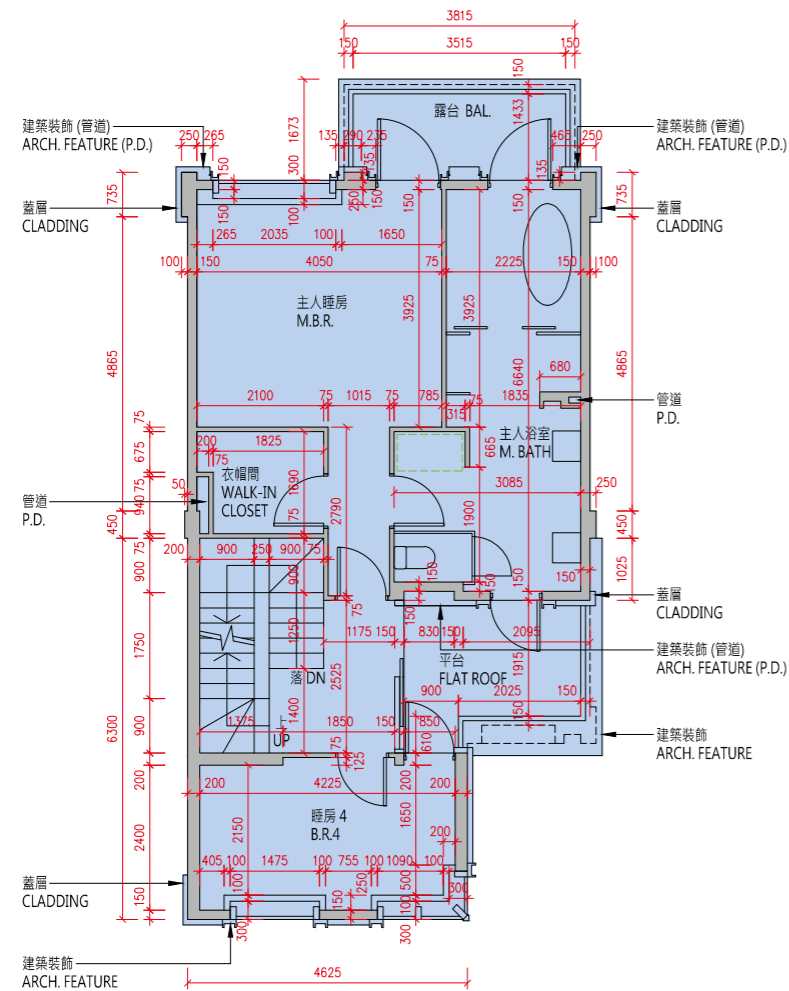
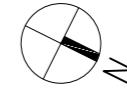

2樓平面圖
2/F Floor Plan

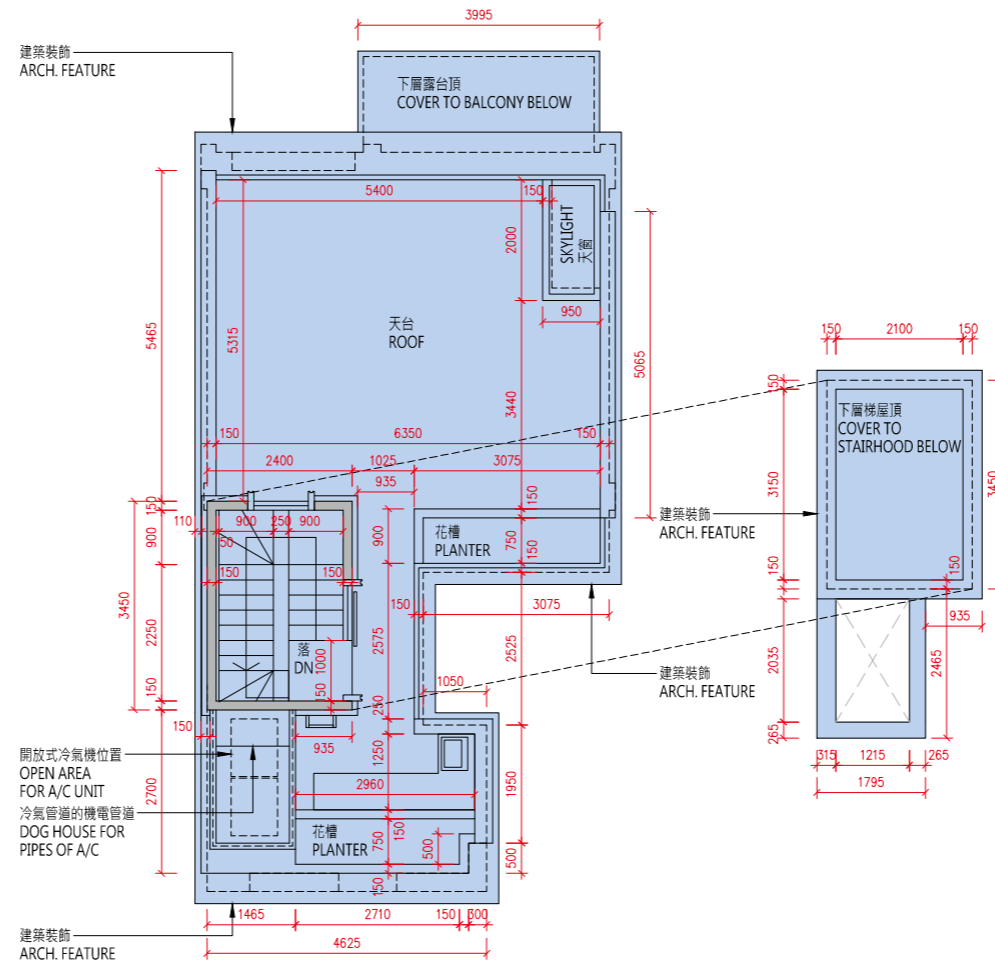

天台平面圖
Roof Floor Plan

比例：0米/M 5米/M
Scale :

樓層 Floor	地庫1樓 B1/F	地下 G/F	1樓 1/F	2樓 2/F	天台 Roof
層與層之間的高度 (毫米) Floor to Floor Height (mm)	4350, 4950, 5350	3750, 3970, 4000	3050, 3080, 3125, 3300	3500	N/A
樓板 (不包括灰泥) 的厚度 (毫米) Thickness of Floor Slab (excluding plaster) (mm)	200	150, 200	150, 200	150, 200	N/A

備註：

(1) 批地文件特別條件第 8(d) 條規定：-

「(d) 在該地段已建成或擬建的住宅單位數目須不少於 515，並就本 (d) 分條而言：

- (i) 一座擬作為單一家庭住宅的獨立屋、半獨立屋或排屋均被視為一個住宅單位；
- (ii) 署長就獨立屋、半獨立屋或排屋是否構成或擬作為單一家庭住宅所作的決定將為最終決定，並對買方構成約束力；及
- (iii) 署長就什麼構成一個住宅單位所作的決定將為最終決定，並對買方構成約束力。」

(2) 公契及管理協議第 85 條規定：-

「管理人須在管理處備存一份由地政總署署長或任何其他不時替代其位的政府主管當局根據本公契附表三第 43 條所發出的同意的資料記錄，以供所有業主免費查閱及自費影印該資料記錄，並繳付合理費用。所有就此收取的費用一律撥入特別基金。」

(3) 公契及管理協議附表三第 43 條規定：-

「43. 除非事先獲得地政總署署長或任何其他不時替代其位的政府主管當局的書面同意，否則任何業主不得進行或允許或容忍他人進行任何與住宅單位相關而可導致該住宅單位內部相連及通往任何毗連或毗鄰的住宅單位的工程，包括但不限於拆卸或更改任何分隔牆或任何樓板或天台樓板或任何間隔結構。而地政總署署長具有全權酌情給予同意或拒絕同意，倘若給予同意，業主須遵從地政總署署長按其全權酌情附加的任何條款及條件（包括支付費用）。」

(4) 發展項目內所提供的住宅單位總數目為 590。

(5) 平面圖所列的數字為以毫米標示之建築結構尺寸。

(6) 因住宅物業的較高樓層的結構牆的厚度遞減，較高樓層的內部面積，一般比較低樓層的內部面積稍大。

(7) 請參閱本售樓說明書第 20 頁為住宅物業樓面平面圖而設之備註及名詞及簡稱的圖例。

Notes:

(1) Special Condition No. (8)(d) of the Land Grant stipulates that: -

“(d) the total number of residential units erected or to be erected on the lot shall not be less than 515, and for the purposes of this sub-clause (d):

- (i) a detached, semi-detached or terraced house which is intended for use as a single family residence shall be regarded as a residential unit;
- (ii) the decision of the Director as to whether a detached, semi-detached or terraced house constitutes or is intended for use as a single family residence shall be final and binding on the Purchaser; and
- (iii) the decision of the Director as to what constitutes a residential unit shall be final and binding on the Purchaser.”

(2) Clause 85 of the Deed of Mutual Covenant incorporating Management Agreement stipulates that: -

“85. The Manager shall deposit in the management office the record provided by the Director of Lands or any other Government authority in place of him from time to time of the information relating to the consent given under Clause 43 of the Third Schedule hereto for inspection by all Owners free of charge and taking copies at their own expense and on payment of a reasonable charge. All charges received shall be credited to the Special Fund.”

(3) Clause 43 of the Third Schedule to the Deed of Mutual Covenant incorporating Management Agreement stipulates that: -

“43. No Owner shall carry out or permit or suffer to be carried out any works in connection with any Residential Unit, including but not limited to demolition or alteration of any partition wall or any floor or roof slab or any partition structure, which will result in such Residential Unit being internally linked to and accessible from any adjoining or adjacent Residential Unit, except with the prior written consent of the Director of Lands or any other Government authority in place of him from time to time, which consent may be given or withheld at his absolute discretion and if given, may be subject to such terms and conditions (including payment of fees) as may be imposed by him at his absolute discretion.”

(4) The total number of residential units provided in the development is 590.

(5) The dimensions in floor plans are all structural dimensions in millimeter.

(6) The internal areas of the residential properties on the upper floors will generally be slightly larger than those on the lower floors because of the reducing thickness of the structural walls on the upper floors.

(7) Please refer to page 20 of this sales brochure for the remarks and legends of the terms and abbreviations for the floor plans of residential properties.

C3洋房
House C3

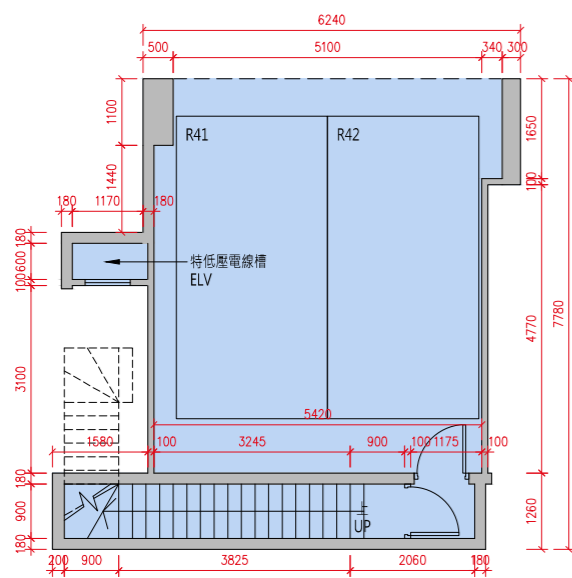

地庫1樓平面圖
B1/F Floor Plan

貼鄰住客停車位的面積 (不計算入停車位面積或實用面積):
C3 洋房地庫 1 樓為 10.547 平方米 (114 平方呎)。
Area adjoining residential parking space (not included in the area of parking space or saleable area): House C3 on B1/F is 10.547 sq.m. (114sq.ft.)

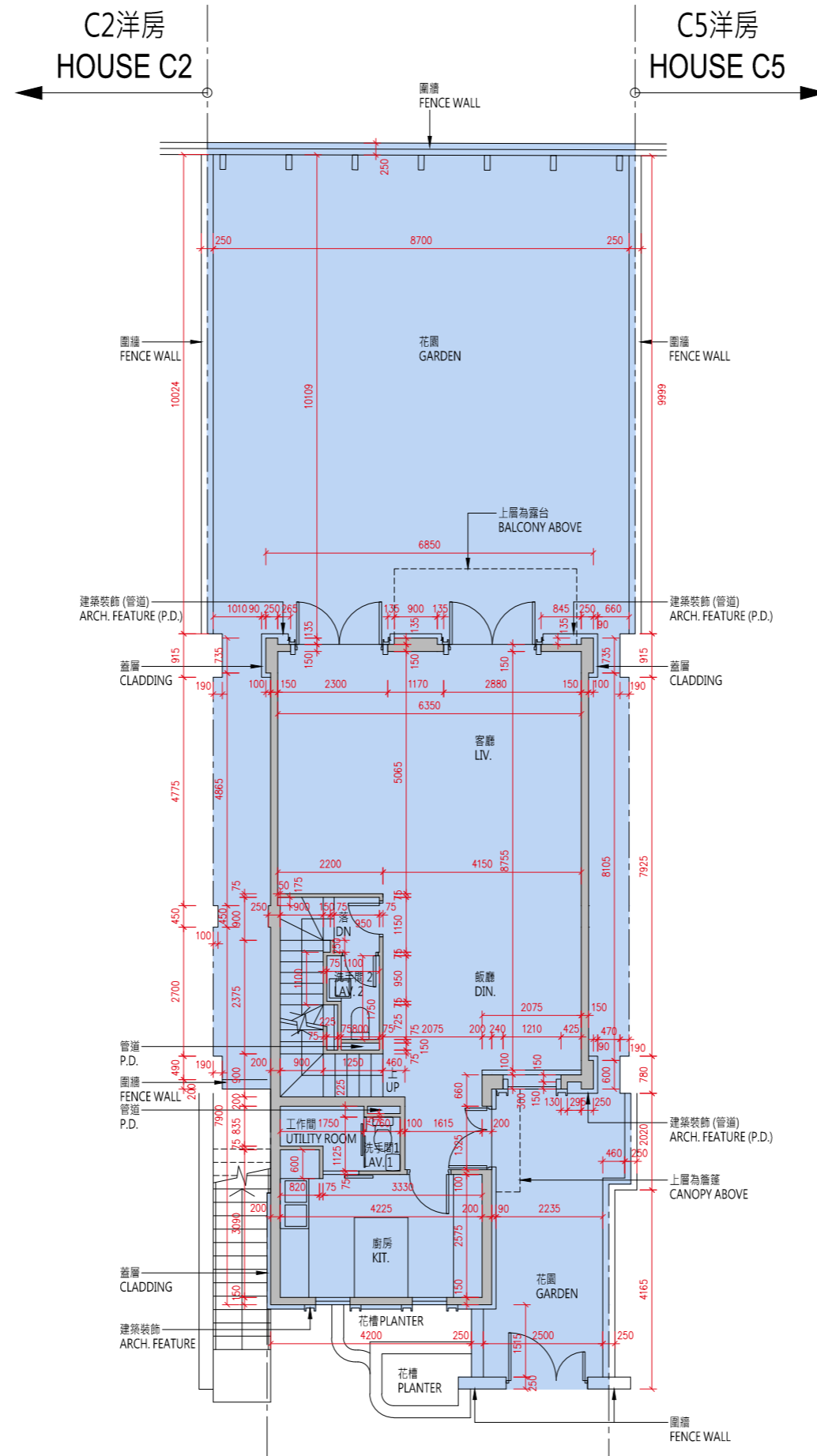

地下平面圖
G/F Floor Plan

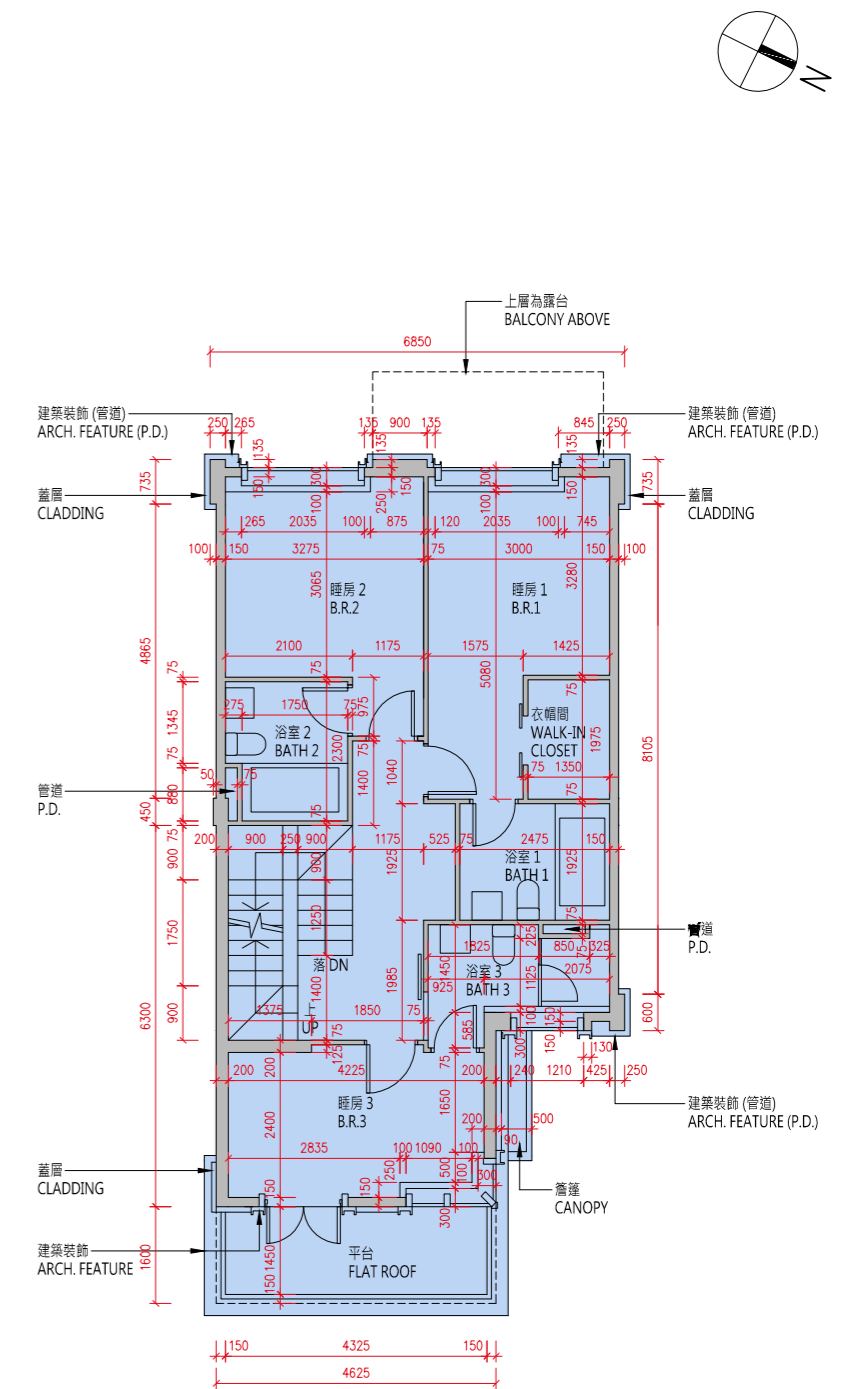

1樓平面圖
1/F Floor Plan

比例 : 0米/M 5米/M
Scale :

C3洋房
House C3

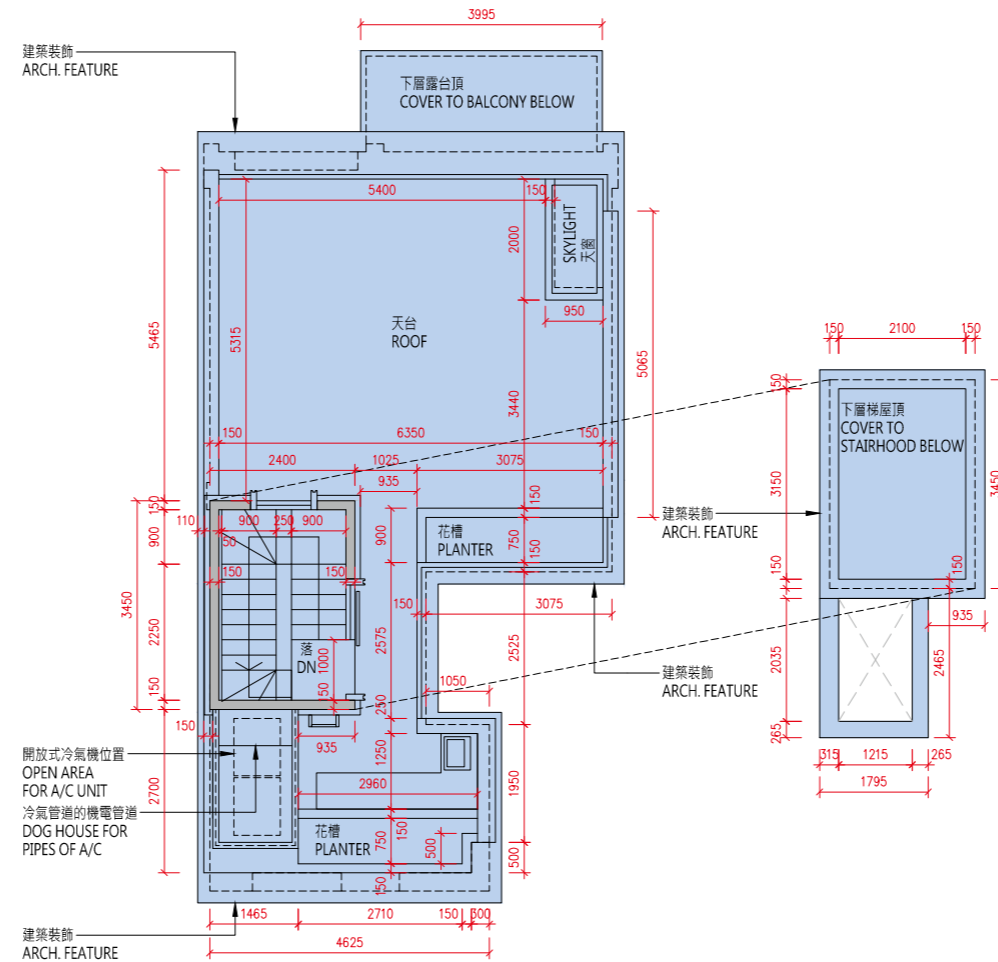
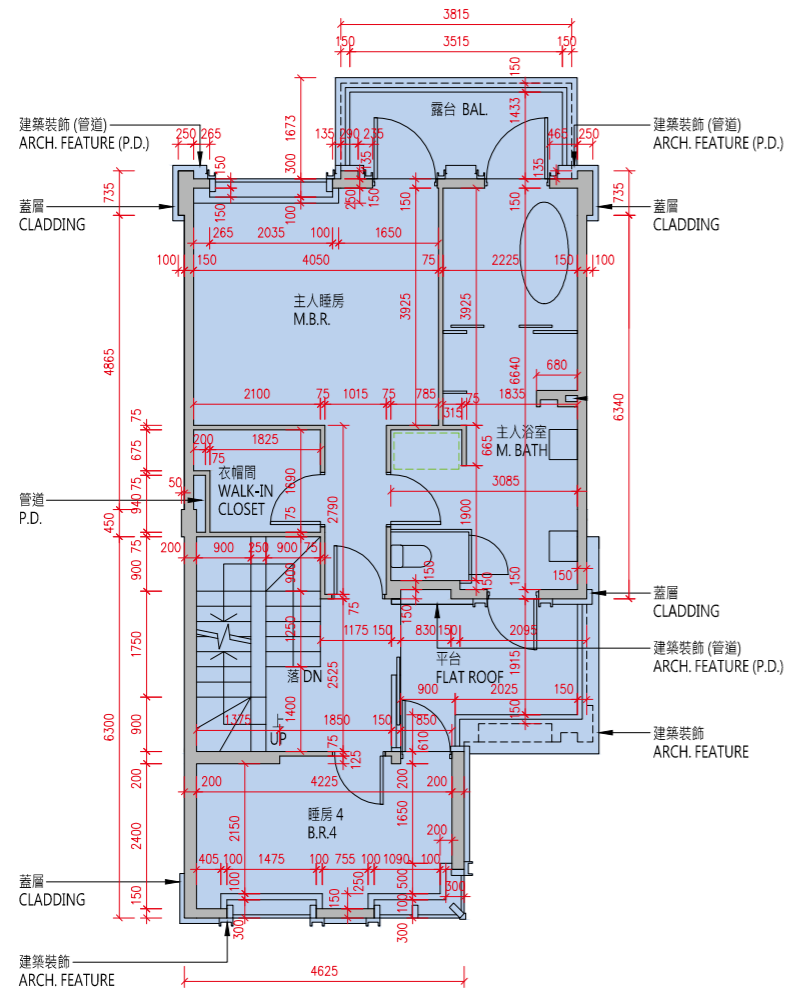
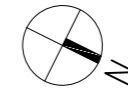

比例：0米/M 5米/M
Scale :

樓層 Floor	地庫1樓 B1/F	地下 G/F	1樓 1/F	2樓 2/F	天台 Roof
層與層之間的高度 (毫米) Floor to Floor Height (mm)	4350, 4950, 5350	3750, 3970, 4000	3050, 3080, 3125, 3300	3500	N/A
樓板 (不包括灰泥) 的厚度 (毫米) Thickness of Floor Slab (excluding plaster) (mm)	200	150, 200	150, 200	150, 200	N/A

10 發展項目的住宅物業的樓面平面圖

FLOOR PLANS OF RESIDENTIAL PROPERTIES IN THE DEVELOPMENT

備註：

- (1) 批地文件特別條件第 8(d) 條規定：-
「(d) 在該地段已建成或擬建的住宅單位數目須不少於 515，並就本 (d) 分條而言：
 - (i) 一座擬作為單一家庭住宅的獨立屋、半獨立屋或排屋均被視為一個住宅單位；
 - (ii) 署長就獨立屋、半獨立屋或排屋是否構成或擬作為單一家庭住宅所作的決定將為最終決定，並對買方構成約束力；及
 - (iii) 署長就什麼構成一個住宅單位所作的決定將為最終決定，並對買方構成約束力。」
- (2) 公契及管理協議第 85 條規定：-
「管理人須在管理處備存一份由地政總署署長或任何其他不時替代其位的政府主管當局根據本公契附表三第 43 條所發出的同意的資料記錄，以供所有業主免費查閱及自費影印該資料記錄，並繳付合理費用。所有就此收取的費用一律撥入特別基金。」
- (3) 公契及管理協議附表三第 43 條規定：-
「43. 除非事先獲得地政總署署長或任何其他不時替代其位的政府主管當局的書面同意，否則任何業主不得進行或允許或容忍他人進行任何與住宅單位相關而可導致該住宅單位內部相連及通往任何毗連或毗鄰的住宅單位的工程，包括但不限於拆卸或更改任何分隔牆或任何樓板或天台樓板或任何間隔結構。而地政總署署長具有全權酌情給予同意或拒絕同意，倘若給予同意，業主須遵從地政總署署長按其全權酌情附加的任何條款及條件（包括支付費用）。」
- (4) 發展項目內所提供的住宅單位總數目為 590。
- (5) 平面圖所列的數字為以毫米標示之建築結構尺寸。
- (6) 因住宅物業的較高樓層的結構牆的厚度遞減，較高樓層的內部面積，一般比較低樓層的內部面積稍大。
- (7) 請參閱本售樓說明書第 20 頁為住宅物業樓面平面圖而設之備註及名詞及簡稱的圖例。

Notes:

- (1) Special Condition No. (8)(d) of the Land Grant stipulates that: -
“(d) the total number of residential units erected or to be erected on the lot shall not be less than 515, and for the purposes of this sub-clause (d):
 - (i) a detached, semi-detached or terraced house which is intended for use as a single family residence shall be regarded as a residential unit;
 - (ii) the decision of the Director as to whether a detached, semi-detached or terraced house constitutes or is intended for use as a single family residence shall be final and binding on the Purchaser; and
 - (iii) the decision of the Director as to what constitutes a residential unit shall be final and binding on the Purchaser.”
- (2) Clause 85 of the Deed of Mutual Covenant incorporating Management Agreement stipulates that: -
“85. The Manager shall deposit in the management office the record provided by the Director of Lands or any other Government authority in place of him from time to time of the information relating to the consent given under Clause 43 of the Third Schedule hereto for inspection by all Owners free of charge and taking copies at their own expense and on payment of a reasonable charge. All charges received shall be credited to the Special Fund.”
- (3) Clause 43 of the Third Schedule to the Deed of Mutual Covenant incorporating Management Agreement stipulates that: -
“43. No Owner shall carry out or permit or suffer to be carried out any works in connection with any Residential Unit, including but not limited to demolition or alteration of any partition wall or any floor or roof slab or any partition structure, which will result in such Residential Unit being internally linked to and accessible from any adjoining or adjacent Residential Unit, except with the prior written consent of the Director of Lands or any other Government authority in place of him from time to time, which consent may be given or withheld at his absolute discretion and if given, may be subject to such terms and conditions (including payment of fees) as may be imposed by him at his absolute discretion.”
- (4) The total number of residential units provided in the development is 590.
- (5) The dimensions in floor plans are all structural dimensions in millimeter.
- (6) The internal areas of the residential properties on the upper floors will generally be slightly larger than those on the lower floors because of the reducing thickness of the structural walls on the upper floors.
- (7) Please refer to page 20 of this sales brochure for the remarks and legends of the terms and abbreviations for the floor plans of residential properties.

C5洋房
House C5

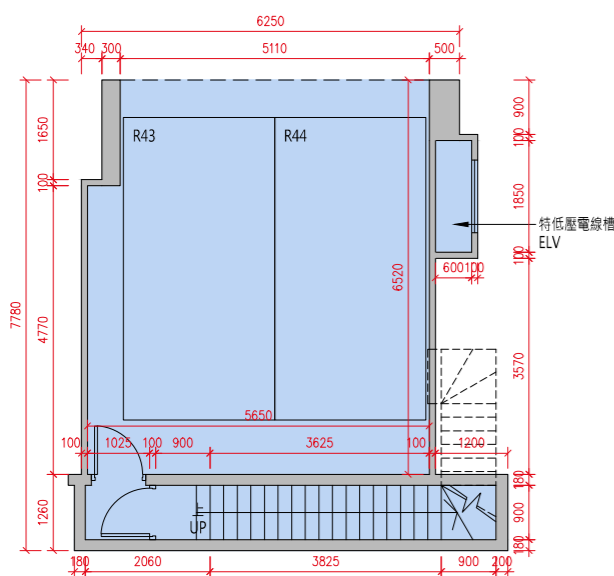

地庫1樓平面圖
B1/F Floor Plan

貼鄰住客停車位的面積 (不計算入停車位面積或實用面積) :
C5 洋房地庫 1 樓為 10.893 平方米 (117 平方呎)。
Area adjoining residential parking space (not included in the area of parking space or saleable area): House C5 on B1/F is 10.893sq.m. (117sq.ft.)

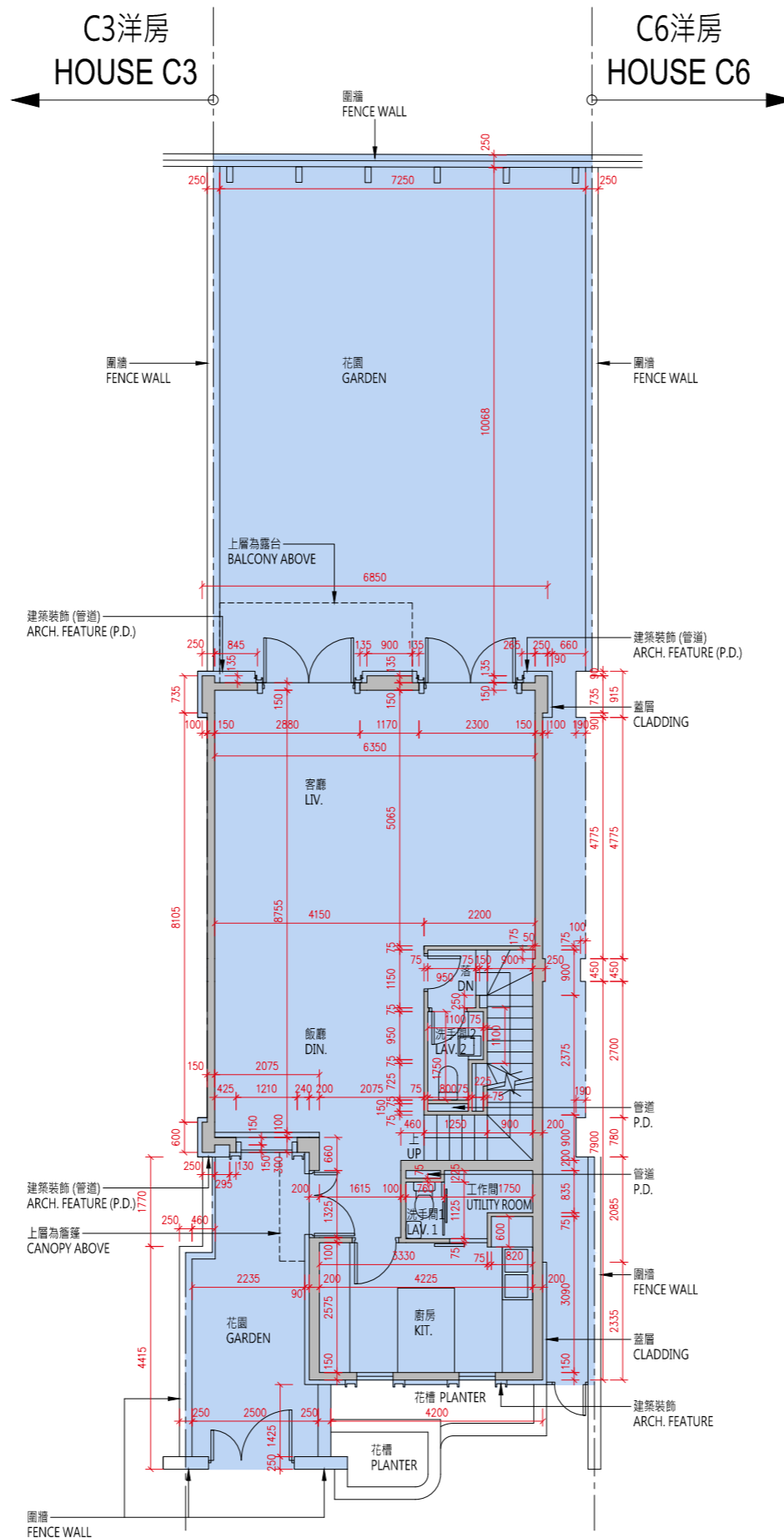

地下平面圖
G/F Floor Plan

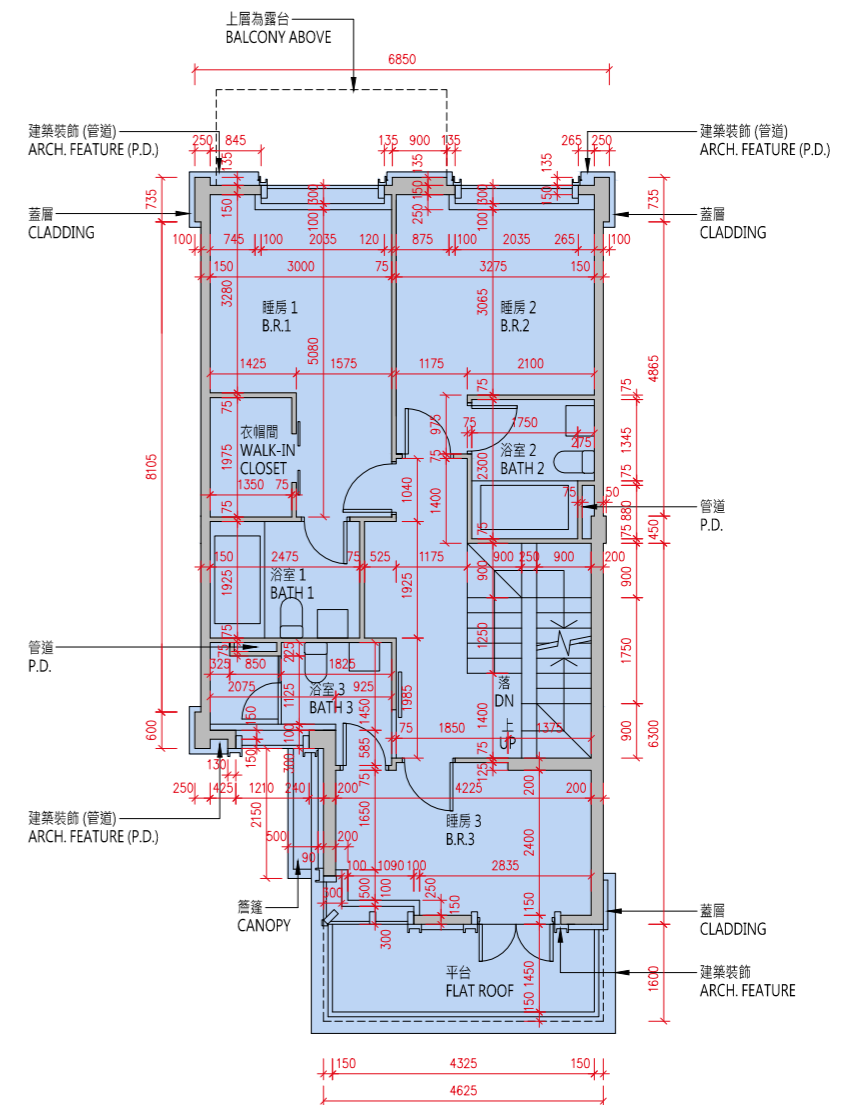

1樓平面圖
1/F Floor Plan

比例 : 0米/M 5米/M
Scale :

C5洋房
House C5

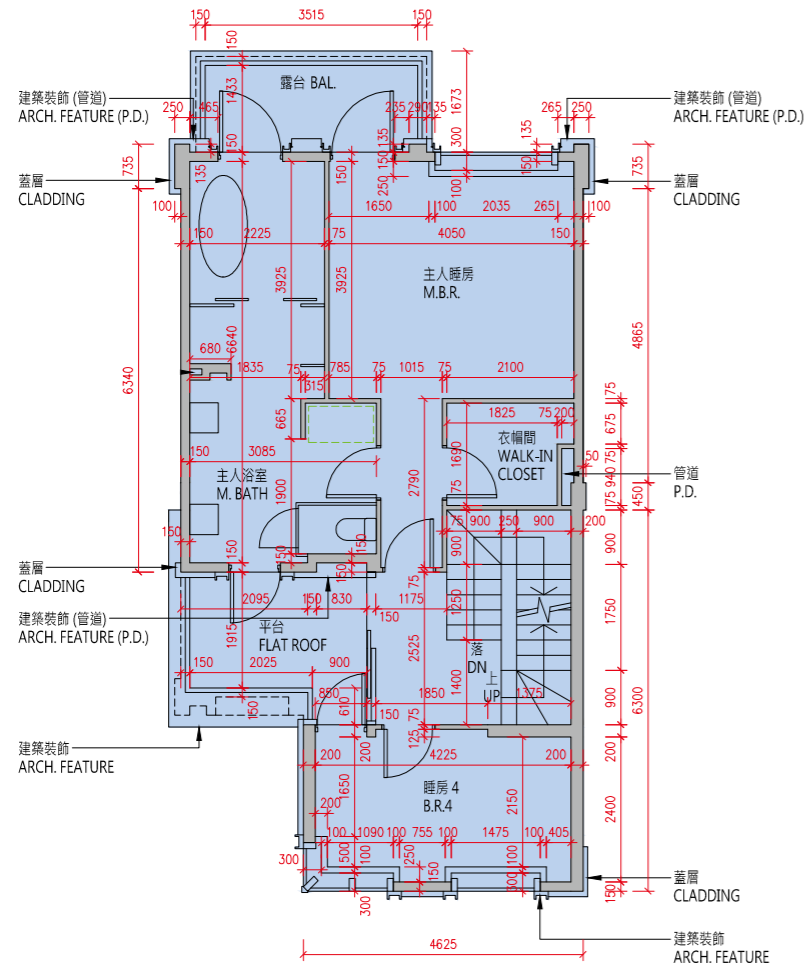
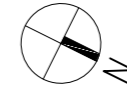

2樓平面圖
2/F Floor Plan

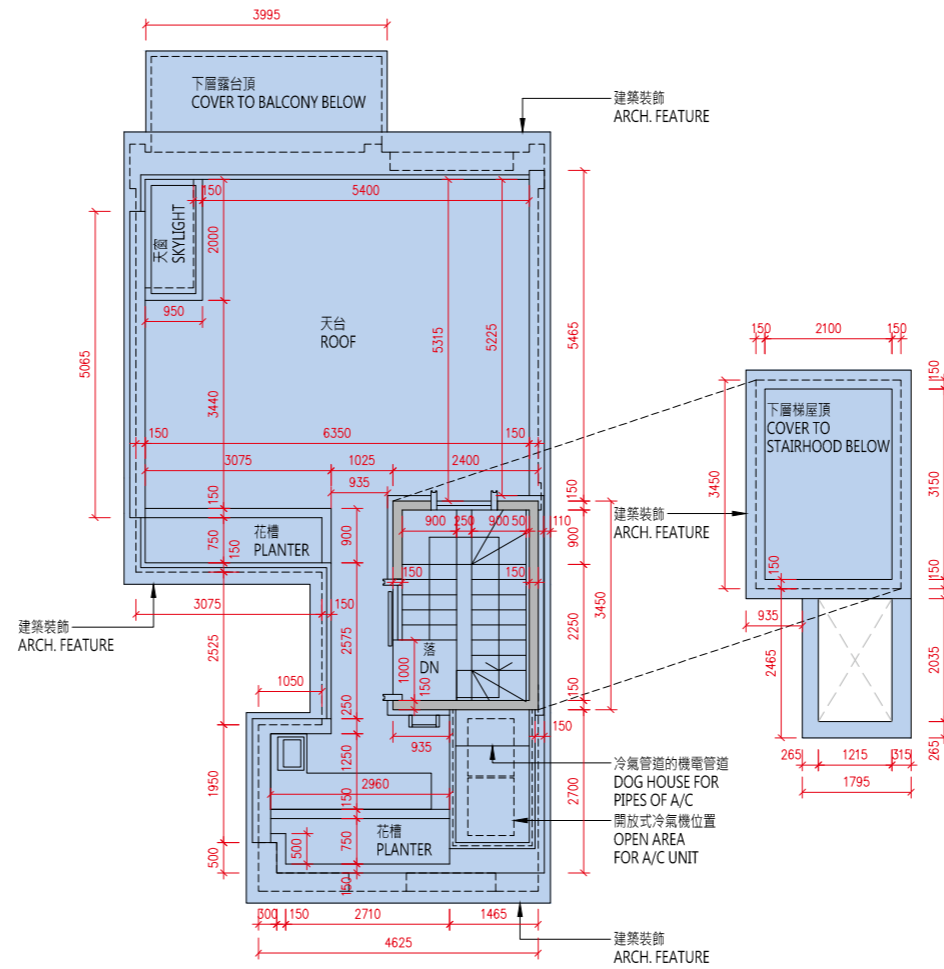

天台平面圖
Roof Floor Plan

比例：0米/M 5米/M
Scale :

樓層 Floor	地庫1樓 B1/F	地下 G/F	1樓 1/F	2樓 2/F	天台 Roof
層與層之間的高度 (毫米) Floor to Floor Height (mm)	4350, 4950, 5350	3750, 3970, 4000	3050, 3080, 3125, 3300	3500	N/A
樓板 (不包括灰泥) 的厚度 (毫米) Thickness of Floor Slab (excluding plaster) (mm)	200	150, 200	150, 200	150, 200	N/A

備註：

(1) 批地文件特別條件第 8(d) 條規定：-

「(d) 在該地段已建成或擬建的住宅單位數目須不少於 515，並就本 (d) 分條而言：

- (i) 一座擬作為單一家庭住宅的獨立屋、半獨立屋或排屋均被視為一個住宅單位；
- (ii) 署長就獨立屋、半獨立屋或排屋是否構成或擬作為單一家庭住宅所作的決定將為最終決定，並對買方構成約束力；及
- (iii) 署長就什麼構成一個住宅單位所作的決定將為最終決定，並對買方構成約束力。」

(2) 公契及管理協議第 85 條規定：-

「管理人須在管理處備存一份由地政總署署長或任何其他不時替代其位的政府主管當局根據本公契附表三第 43 條所發出的同意的資料記錄，以供所有業主免費查閱及自費影印該資料記錄，並繳付合理費用。所有就此收取的費用一律撥入特別基金。」

(3) 公契及管理協議附表三第 43 條規定：-

「43. 除非事先獲得地政總署署長或任何其他不時替代其位的政府主管當局的書面同意，否則任何業主不得進行或允許或容忍他人進行任何與住宅單位相關而可導致該住宅單位內部相連及通往任何毗連或毗鄰的住宅單位的工程，包括但不限於拆卸或更改任何分隔牆或任何樓板或天台樓板或任何間隔結構。而地政總署署長具有全權酌情給予同意或拒絕同意，倘若給予同意，業主須遵從地政總署署長按其全權酌情附加的任何條款及條件（包括支付費用）。」

(4) 發展項目內所提供的住宅單位總數目為 590。

(5) 平面圖所列的數字為以毫米標示之建築結構尺寸。

(6) 因住宅物業的較高樓層的結構牆的厚度遞減，較高樓層的內部面積，一般比較低樓層的內部面積稍大。

(7) 請參閱本售樓說明書第 20 頁為住宅物業樓面平面圖而設之備註及名詞及簡稱的圖例。

Notes:

(1) Special Condition No. (8)(d) of the Land Grant stipulates that: -

“(d) the total number of residential units erected or to be erected on the lot shall not be less than 515, and for the purposes of this sub-clause (d):

- (i) a detached, semi-detached or terraced house which is intended for use as a single family residence shall be regarded as a residential unit;
- (ii) the decision of the Director as to whether a detached, semi-detached or terraced house constitutes or is intended for use as a single family residence shall be final and binding on the Purchaser; and
- (iii) the decision of the Director as to what constitutes a residential unit shall be final and binding on the Purchaser.”

(2) Clause 85 of the Deed of Mutual Covenant incorporating Management Agreement stipulates that: -

“85. The Manager shall deposit in the management office the record provided by the Director of Lands or any other Government authority in place of him from time to time of the information relating to the consent given under Clause 43 of the Third Schedule hereto for inspection by all Owners free of charge and taking copies at their own expense and on payment of a reasonable charge. All charges received shall be credited to the Special Fund.”

(3) Clause 43 of the Third Schedule to the Deed of Mutual Covenant incorporating Management Agreement stipulates that: -

“43. No Owner shall carry out or permit or suffer to be carried out any works in connection with any Residential Unit, including but not limited to demolition or alteration of any partition wall or any floor or roof slab or any partition structure, which will result in such Residential Unit being internally linked to and accessible from any adjoining or adjacent Residential Unit, except with the prior written consent of the Director of Lands or any other Government authority in place of him from time to time, which consent may be given or withheld at his absolute discretion and if given, may be subject to such terms and conditions (including payment of fees) as may be imposed by him at his absolute discretion.”

(4) The total number of residential units provided in the development is 590.

(5) The dimensions in floor plans are all structural dimensions in millimeter.

(6) The internal areas of the residential properties on the upper floors will generally be slightly larger than those on the lower floors because of the reducing thickness of the structural walls on the upper floors.

(7) Please refer to page 20 of this sales brochure for the remarks and legends of the terms and abbreviations for the floor plans of residential properties.

C6洋房
House C6

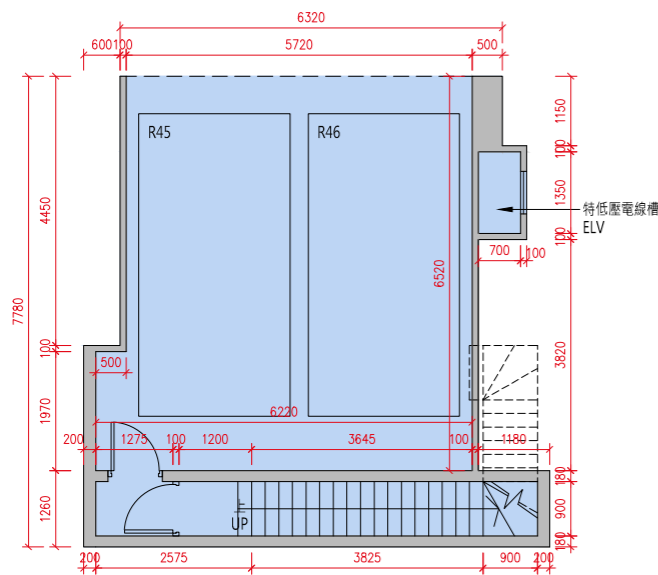

地庫1樓平面圖
B1/F Floor Plan

貼鄰住客停車位的面積 (不計算入停車位面積或實用面積) :
C6 洋房地庫 1 樓為 13.279 平方米 (143 平方呎)。
Area adjoining residential parking space (not included in the area of parking space or saleable area): House C6 on B1/F is 13.279 sq.m. (143sq.ft.)

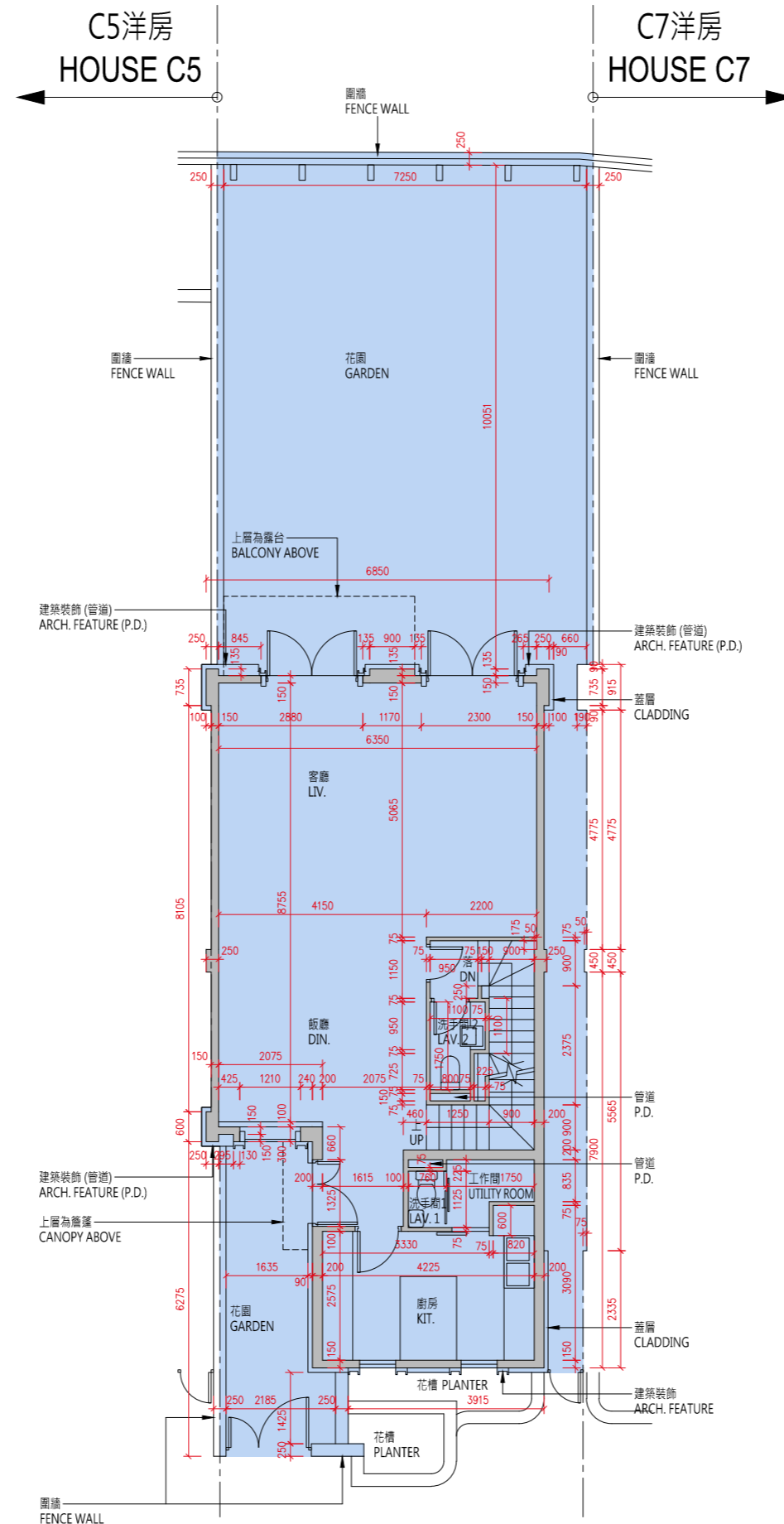

地下平面圖
G/F Floor Plan

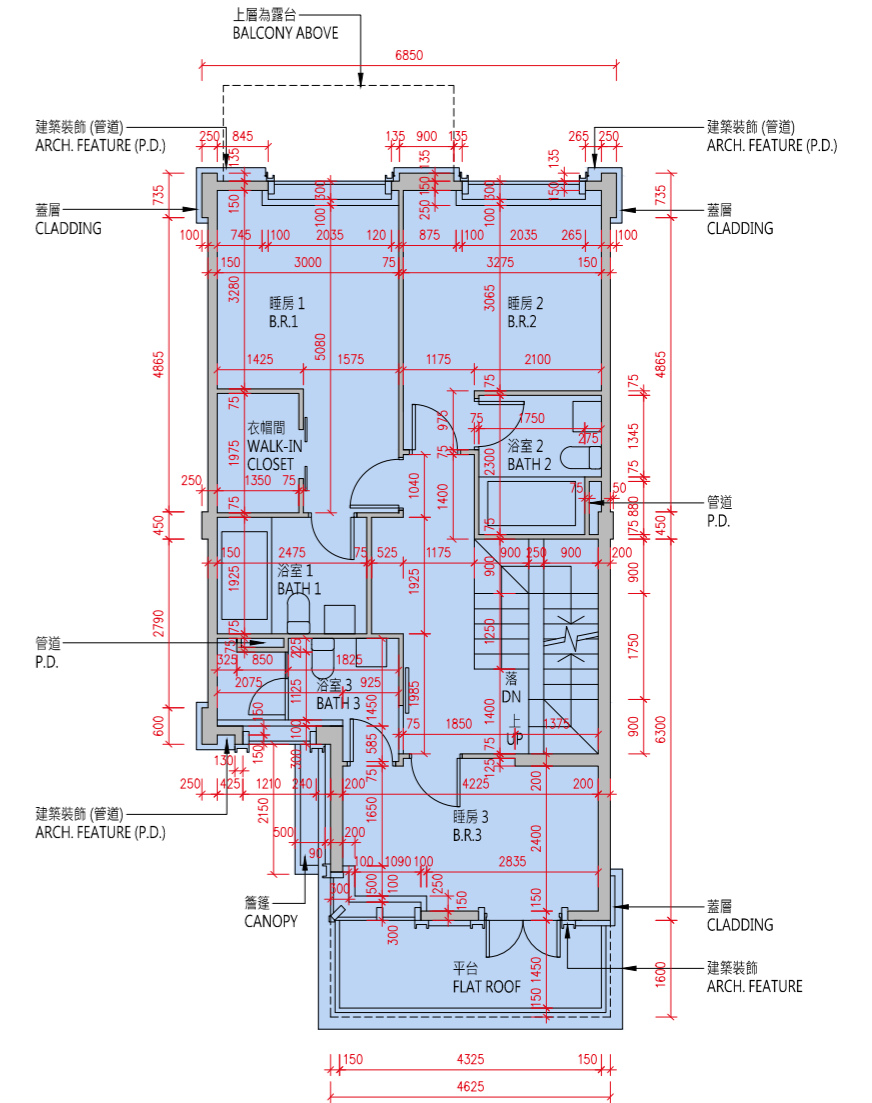

1樓平面圖
1/F Floor Plan

比例 : 0米/M 5米/M
Scale :

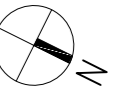

C6洋房
House C6

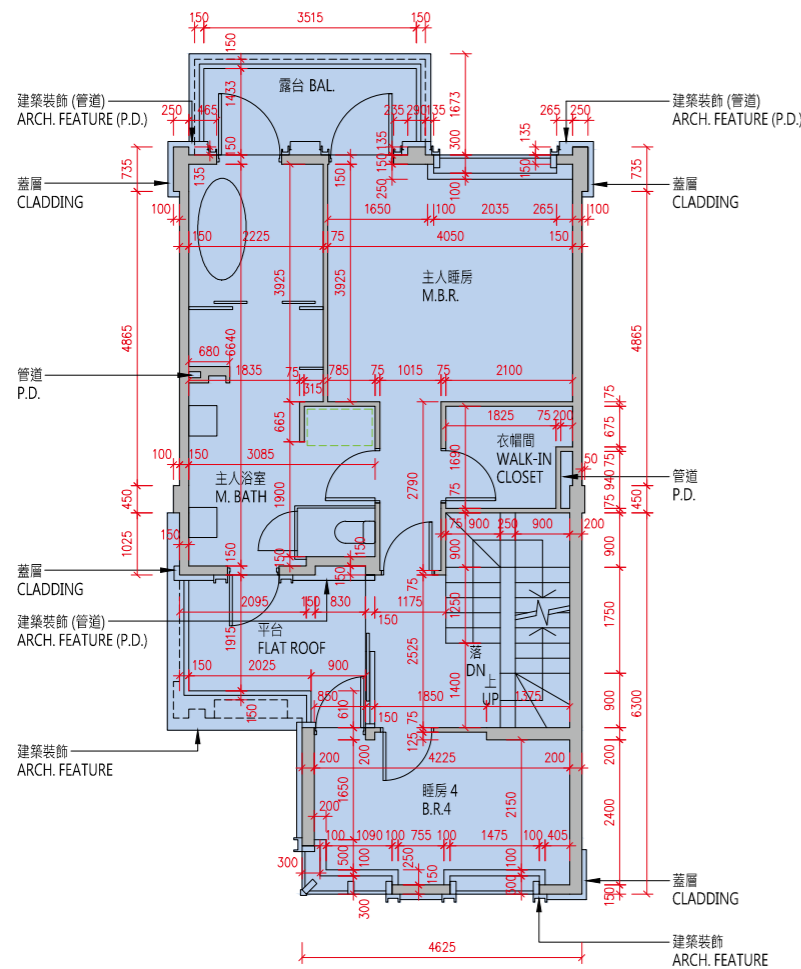
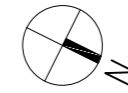

2樓平面圖
2/F Floor Plan

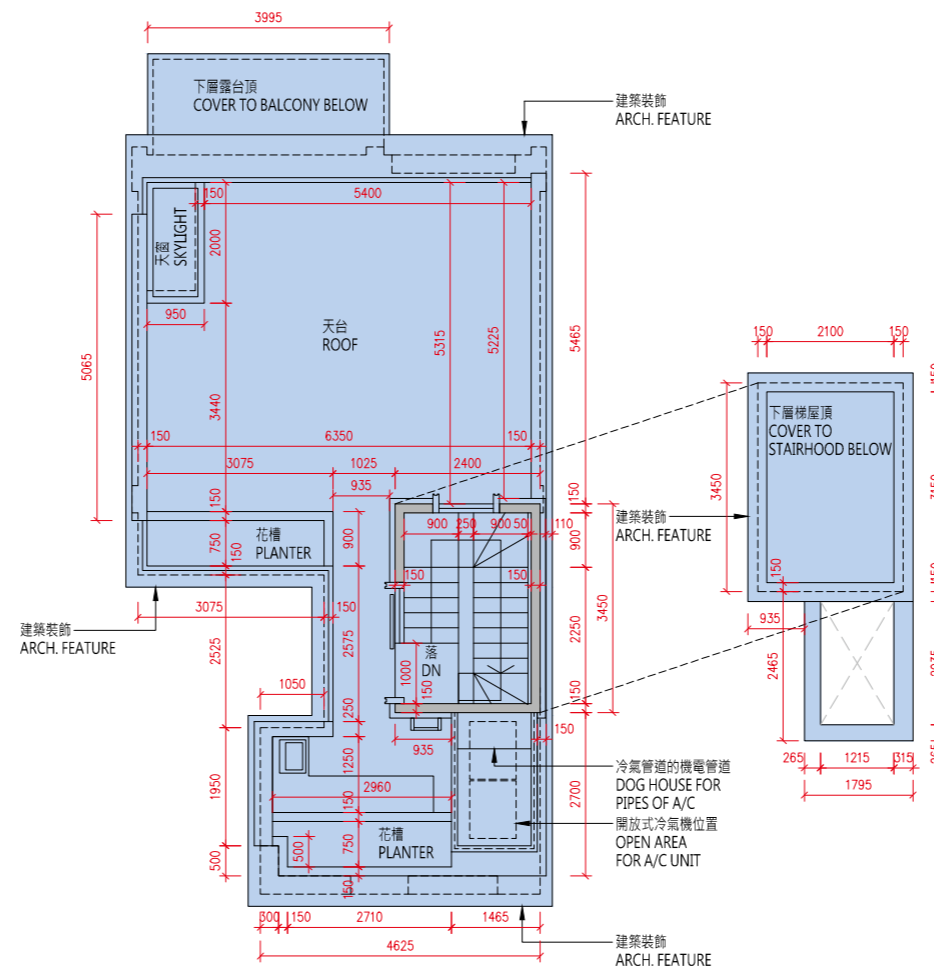

天台平面圖
Roof Floor Plan

比例：0米/M 5米/M
Scale :

樓層 Floor	地庫1樓 B1/F	地下 G/F	1樓 1/F	2樓 2/F	天台 Roof
層與層之間的高度 (毫米) Floor to Floor Height (mm)	4350, 4950, 5350	3750, 3970, 4000	3050, 3080, 3125, 3300	3500	N/A
樓板 (不包括灰泥) 的厚度 (毫米) Thickness of Floor Slab (excluding plaster) (mm)	200	150, 200	150, 200	150, 200	N/A

10 發展項目的住宅物業的樓面平面圖

FLOOR PLANS OF RESIDENTIAL PROPERTIES IN THE DEVELOPMENT

備註：

- (1) 批地文件特別條件第 8(d) 條規定：-
「(d) 在該地段已建成或擬建的住宅單位數目須不少於 515，並就本 (d) 分條而言：
 - (i) 一座擬作為單一家庭住宅的獨立屋、半獨立屋或排屋均被視為一個住宅單位；
 - (ii) 署長就獨立屋、半獨立屋或排屋是否構成或擬作為單一家庭住宅所作的決定將為最終決定，並對買方構成約束力；及
 - (iii) 署長就什麼構成一個住宅單位所作的決定將為最終決定，並對買方構成約束力。」
- (2) 公契及管理協議第 85 條規定：-
「管理人須在管理處備存一份由地政總署署長或任何其他不時替代其位的政府主管當局根據本公契附表三第 43 條所發出的同意的資料記錄，以供所有業主免費查閱及自費影印該資料記錄，並繳付合理費用。所有就此收取的費用一律撥入特別基金。」
- (3) 公契及管理協議附表三第 43 條規定：-
「43. 除非事先獲得地政總署署長或任何其他不時替代其位的政府主管當局的書面同意，否則任何業主不得進行或允許或容忍他人進行任何與住宅單位相關而可導致該住宅單位內部相連及通往任何毗連或毗鄰的住宅單位的工程，包括但不限於拆卸或更改任何分隔牆或任何樓板或天台樓板或任何間隔結構。而地政總署署長具有全權酌情給予同意或拒絕同意，倘若給予同意，業主須遵從地政總署署長按其全權酌情附加的任何條款及條件（包括支付費用）。」
- (4) 發展項目內所提供的住宅單位總數目為 590。
- (5) 平面圖所列的數字為以毫米標示之建築結構尺寸。
- (6) 因住宅物業的較高樓層的結構牆的厚度遞減，較高樓層的內部面積，一般比較低樓層的內部面積稍大。
- (7) 請參閱本售樓說明書第 20 頁為住宅物業樓面平面圖而設之備註及名詞及簡稱的圖例。

Notes:

- (1) Special Condition No. (8)(d) of the Land Grant stipulates that: -
“(d) the total number of residential units erected or to be erected on the lot shall not be less than 515, and for the purposes of this sub-clause (d):
 - (i) a detached, semi-detached or terraced house which is intended for use as a single family residence shall be regarded as a residential unit;
 - (ii) the decision of the Director as to whether a detached, semi-detached or terraced house constitutes or is intended for use as a single family residence shall be final and binding on the Purchaser; and
 - (iii) the decision of the Director as to what constitutes a residential unit shall be final and binding on the Purchaser.”
- (2) Clause 85 of the Deed of Mutual Covenant incorporating Management Agreement stipulates that: -
“85. The Manager shall deposit in the management office the record provided by the Director of Lands or any other Government authority in place of him from time to time of the information relating to the consent given under Clause 43 of the Third Schedule hereto for inspection by all Owners free of charge and taking copies at their own expense and on payment of a reasonable charge. All charges received shall be credited to the Special Fund.”
- (3) Clause 43 of the Third Schedule to the Deed of Mutual Covenant incorporating Management Agreement stipulates that: -
“43. No Owner shall carry out or permit or suffer to be carried out any works in connection with any Residential Unit, including but not limited to demolition or alteration of any partition wall or any floor or roof slab or any partition structure, which will result in such Residential Unit being internally linked to and accessible from any adjoining or adjacent Residential Unit, except with the prior written consent of the Director of Lands or any other Government authority in place of him from time to time, which consent may be given or withheld at his absolute discretion and if given, may be subject to such terms and conditions (including payment of fees) as may be imposed by him at his absolute discretion.”
- (4) The total number of residential units provided in the development is 590.
- (5) The dimensions in floor plans are all structural dimensions in millimeter.
- (6) The internal areas of the residential properties on the upper floors will generally be slightly larger than those on the lower floors because of the reducing thickness of the structural walls on the upper floors.
- (7) Please refer to page 20 of this sales brochure for the remarks and legends of the terms and abbreviations for the floor plans of residential properties.

C7洋房
House C7

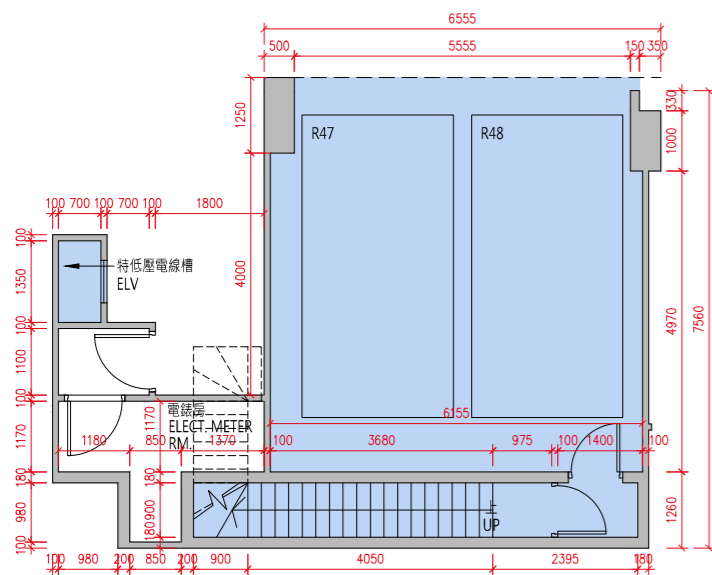

地庫1樓平面圖
B1/F Floor Plan

貼鄰住客停車位的面積 (不計算入停車位面積或實用面積):
C7 洋房地庫 1 樓為 14.321 平方米 (154 平方呎)。
Area adjoining residential parking space (not included in the area of parking space or saleable area): House C7 on B1/F is 14.321 sq.m. (154sq.ft.)

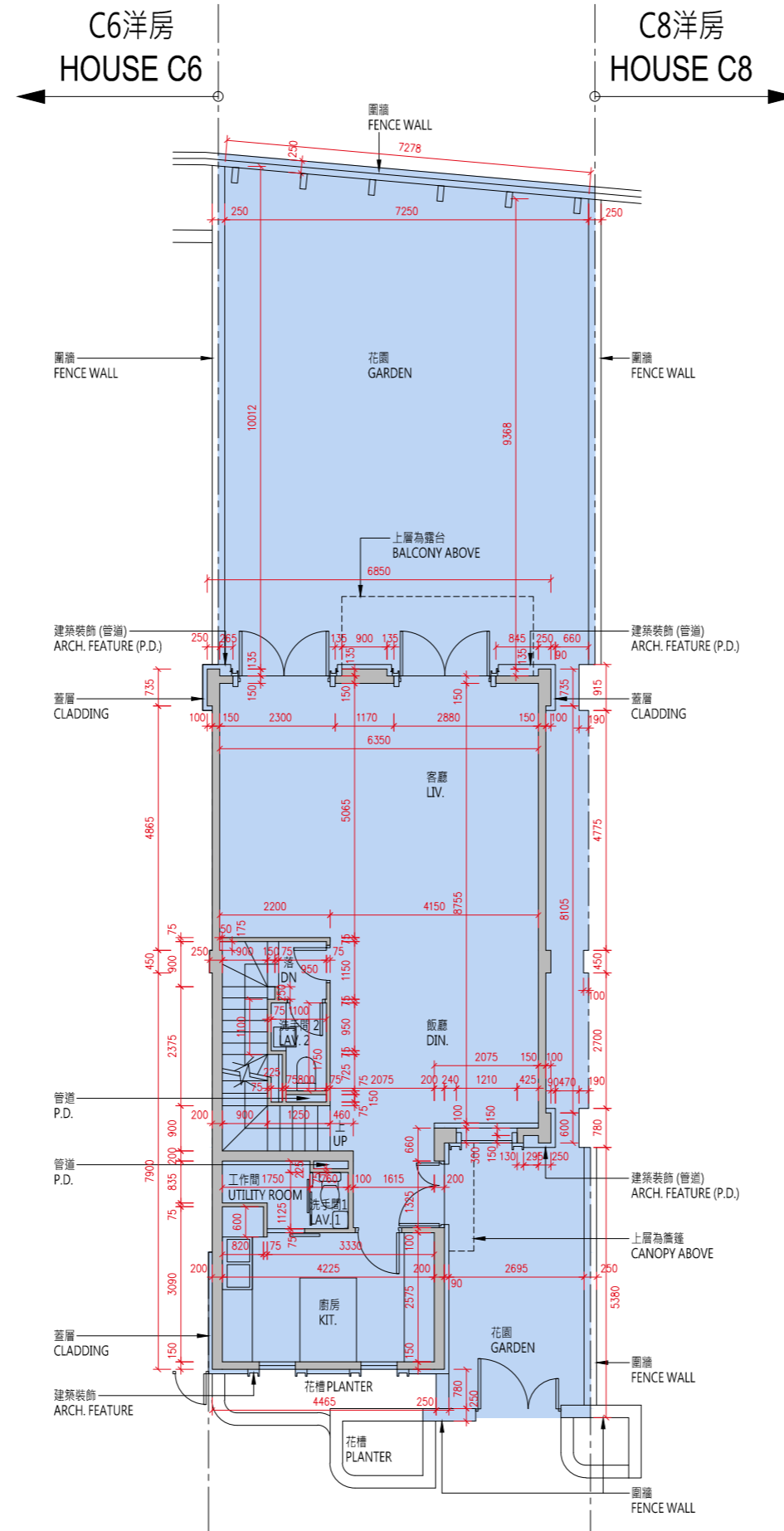

地下平面圖
G/F Floor Plan

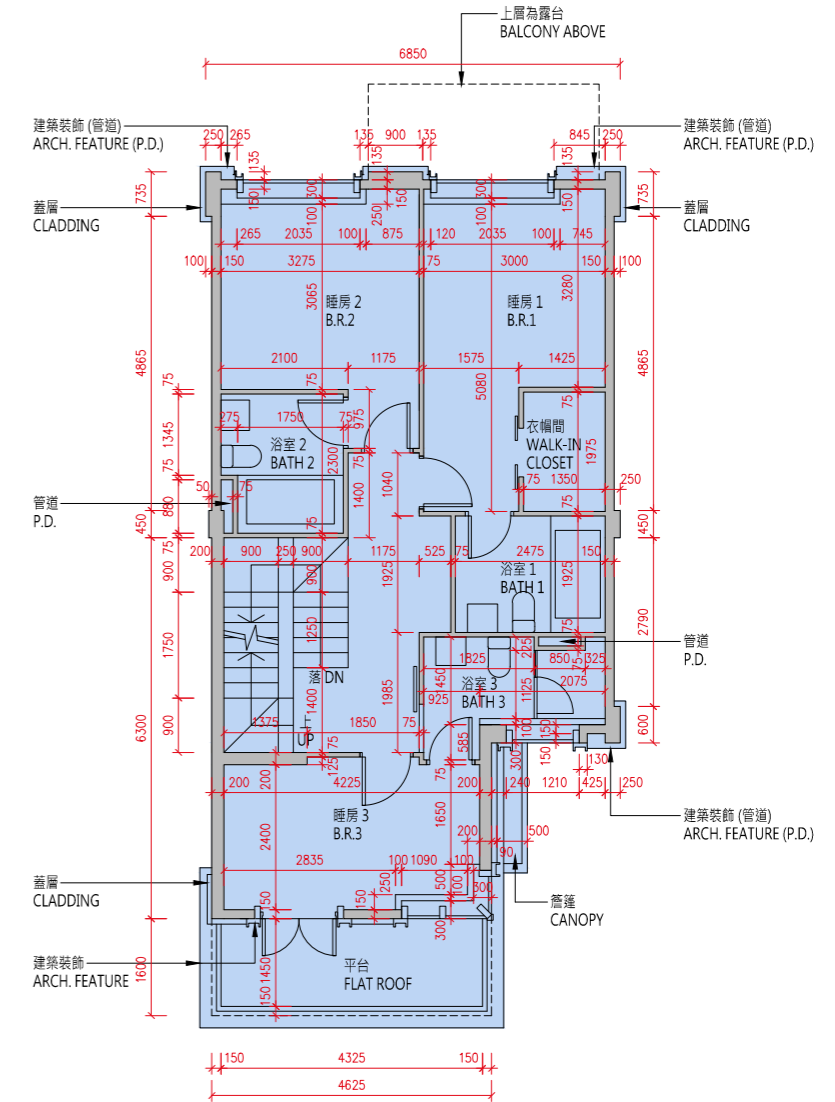

1樓平面圖
1/F Floor Plan

比例 :0米/M 5米/M
Scale :

C7洋房
House C7

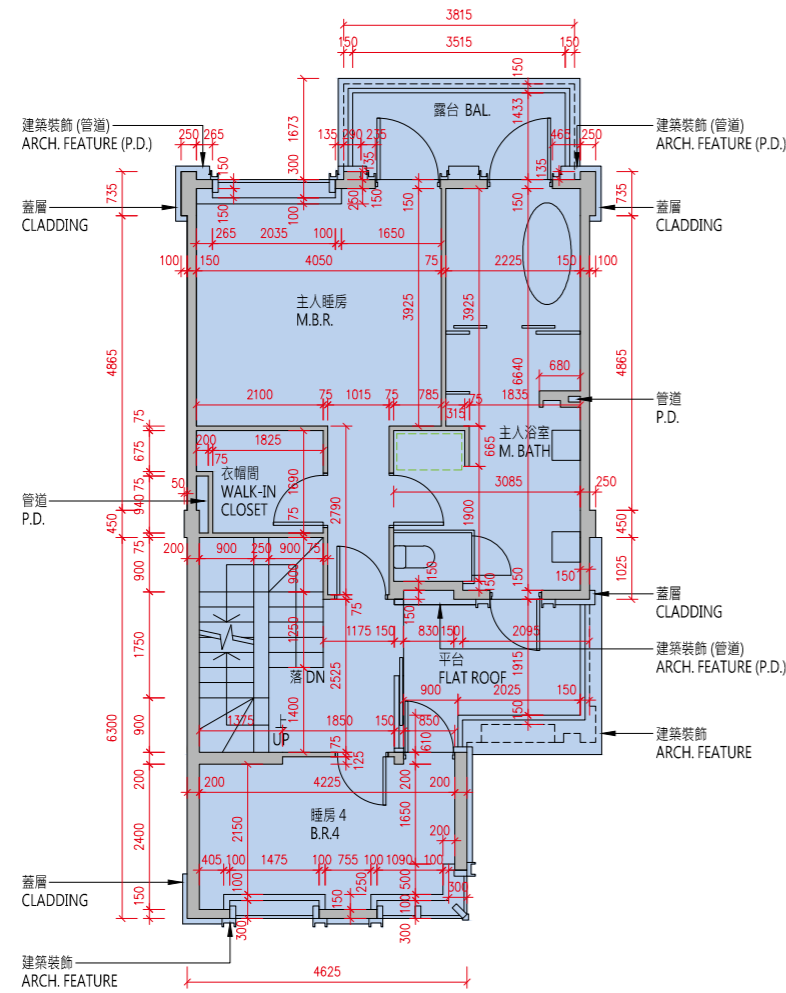
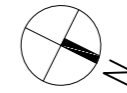

2樓平面圖
2/F Floor Plan

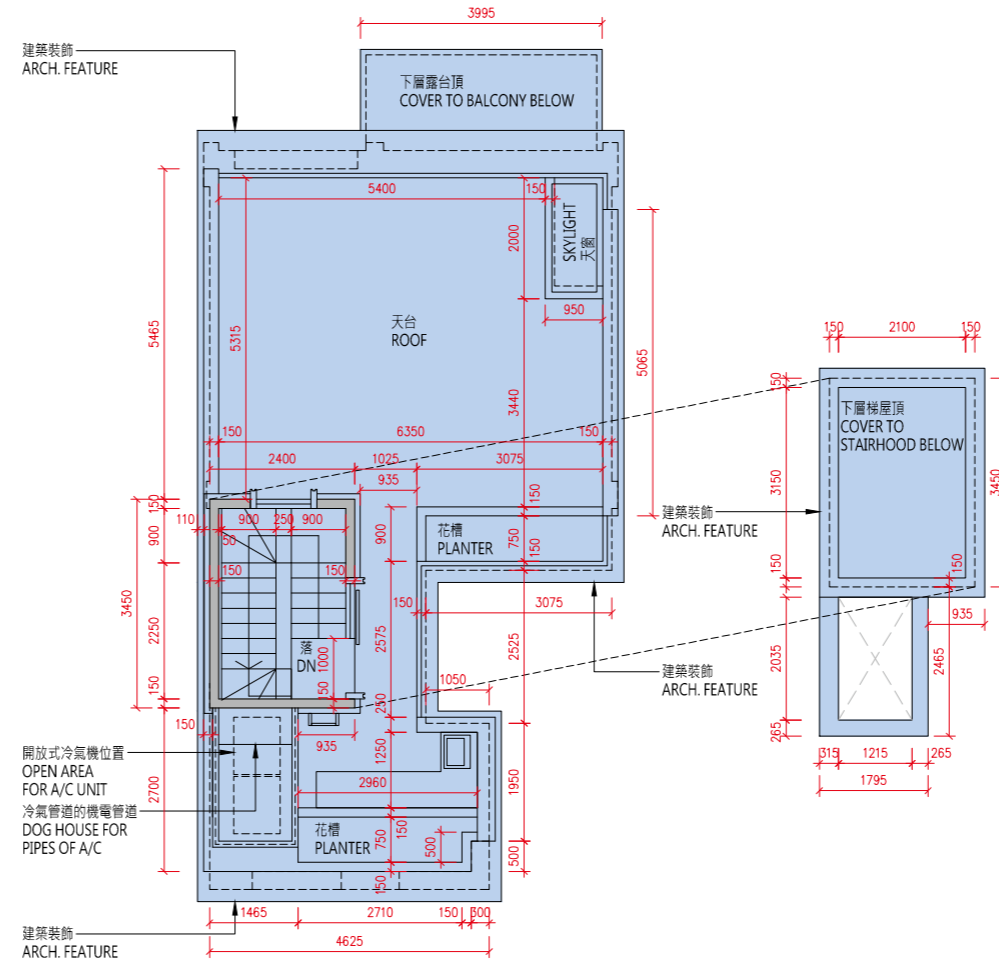

天台平面圖
Roof Floor Plan

比例：0米/M 5米/M
Scale : 5米/M

樓層 Floor	地庫1樓 B1/F	地下 G/F	1樓 1/F	2樓 2/F	天台 Roof
層與層之間的高度 (毫米) Floor to Floor Height (mm)	4350, 4950, 5350	3750, 3970, 4000	3050, 3080, 3125, 3300	3500	N/A
樓板 (不包括灰泥) 的厚度 (毫米) Thickness of Floor Slab (excluding plaster) (mm)	200	150, 200	150, 200	150, 200	N/A

備註：

(1) 批地文件特別條件第 8(d) 條規定：-

「(d) 在該地段已建成或擬建的住宅單位數目須不少於 515，並就本 (d) 分條而言：

- (i) 一座擬作為單一家庭住宅的獨立屋、半獨立屋或排屋均被視為一個住宅單位；
- (ii) 署長就獨立屋、半獨立屋或排屋是否構成或擬作為單一家庭住宅所作的決定將為最終決定，並對買方構成約束力；及
- (iii) 署長就什麼構成一個住宅單位所作的決定將為最終決定，並對買方構成約束力。」

(2) 公契及管理協議第 85 條規定：-

「管理人須在管理處備存一份由地政總署署長或任何其他不時替代其位的政府主管當局根據本公契附表三第 43 條所發出的同意的資料記錄，以供所有業主免費查閱及自費影印該資料記錄，並繳付合理費用。所有就此收取的費用一律撥入特別基金。」

(3) 公契及管理協議附表三第 43 條規定：-

「43. 除非事先獲得地政總署署長或任何其他不時替代其位的政府主管當局的書面同意，否則任何業主不得進行或允許或容忍他人進行任何與住宅單位相關而可導致該住宅單位內部相連及通往任何毗連或毗鄰的住宅單位的工程，包括但不限於拆卸或更改任何分隔牆或任何樓板或天台樓板或任何間隔結構。而地政總署署長具有全權酌情給予同意或拒絕同意，倘若給予同意，業主須遵從地政總署署長按其全權酌情附加的任何條款及條件（包括支付費用）。」

(4) 發展項目內所提供的住宅單位總數目為 590。

(5) 平面圖所列的數字為以毫米標示之建築結構尺寸。

(6) 因住宅物業的較高樓層的結構牆的厚度遞減，較高樓層的內部面積，一般比較低樓層的內部面積稍大。

(7) 請參閱本售樓說明書第 20 頁為住宅物業樓面平面圖而設之備註及名詞及簡稱的圖例。

Notes:

(1) Special Condition No. (8)(d) of the Land Grant stipulates that: -

“(d) the total number of residential units erected or to be erected on the lot shall not be less than 515, and for the purposes of this sub-clause (d):

- (i) a detached, semi-detached or terraced house which is intended for use as a single family residence shall be regarded as a residential unit;
- (ii) the decision of the Director as to whether a detached, semi-detached or terraced house constitutes or is intended for use as a single family residence shall be final and binding on the Purchaser; and
- (iii) the decision of the Director as to what constitutes a residential unit shall be final and binding on the Purchaser.”

(2) Clause 85 of the Deed of Mutual Covenant incorporating Management Agreement stipulates that: -

“85. The Manager shall deposit in the management office the record provided by the Director of Lands or any other Government authority in place of him from time to time of the information relating to the consent given under Clause 43 of the Third Schedule hereto for inspection by all Owners free of charge and taking copies at their own expense and on payment of a reasonable charge. All charges received shall be credited to the Special Fund.”

(3) Clause 43 of the Third Schedule to the Deed of Mutual Covenant incorporating Management Agreement stipulates that: -

“43. No Owner shall carry out or permit or suffer to be carried out any works in connection with any Residential Unit, including but not limited to demolition or alteration of any partition wall or any floor or roof slab or any partition structure, which will result in such Residential Unit being internally linked to and accessible from any adjoining or adjacent Residential Unit, except with the prior written consent of the Director of Lands or any other Government authority in place of him from time to time, which consent may be given or withheld at his absolute discretion and if given, may be subject to such terms and conditions (including payment of fees) as may be imposed by him at his absolute discretion.”

(4) The total number of residential units provided in the development is 590.

(5) The dimensions in floor plans are all structural dimensions in millimeter.

(6) The internal areas of the residential properties on the upper floors will generally be slightly larger than those on the lower floors because of the reducing thickness of the structural walls on the upper floors.

(7) Please refer to page 20 of this sales brochure for the remarks and legends of the terms and abbreviations for the floor plans of residential properties.

10 發展項目的住宅物業的樓面平面圖 FLOOR PLANS OF RESIDENTIAL PROPERTIES IN THE DEVELOPMENT

C8洋房
House C8

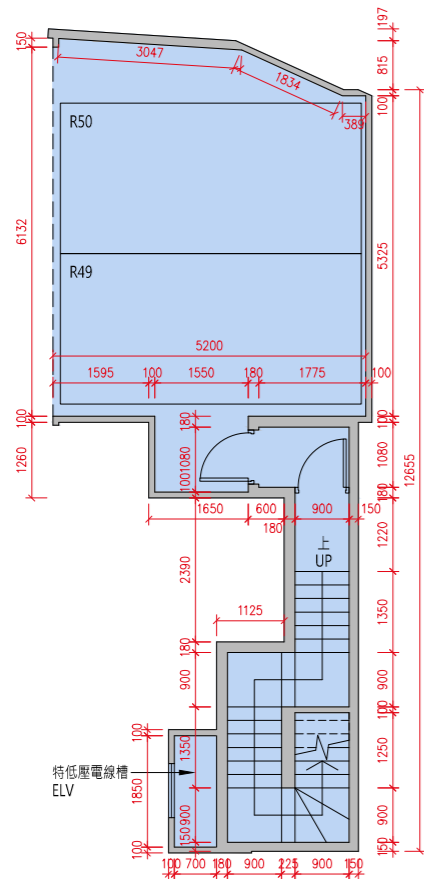

地庫1樓平面圖
B1/F Floor Plan

貼鄰住客停車位的面積 (不計算入停車位面積或實用面積) :
C8 洋房地庫 1 樓為 7.956 平方米 (86 平方呎)。
Area adjoining residential parking space (not included in the area of parking space or saleable area): House C8 on B1/F is 7.956 sq.m. (86sq.ft.)

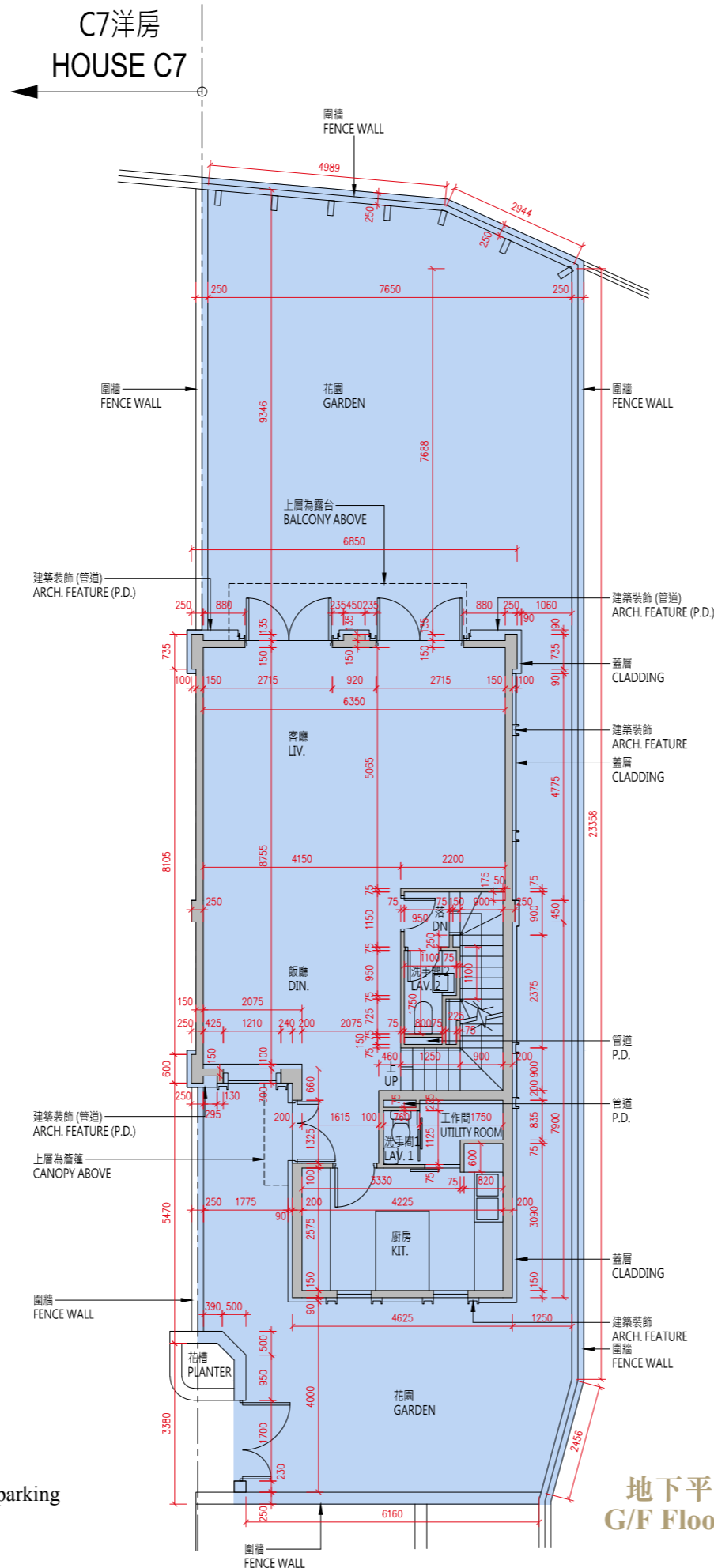

地下平面圖
G/F Floor Plan

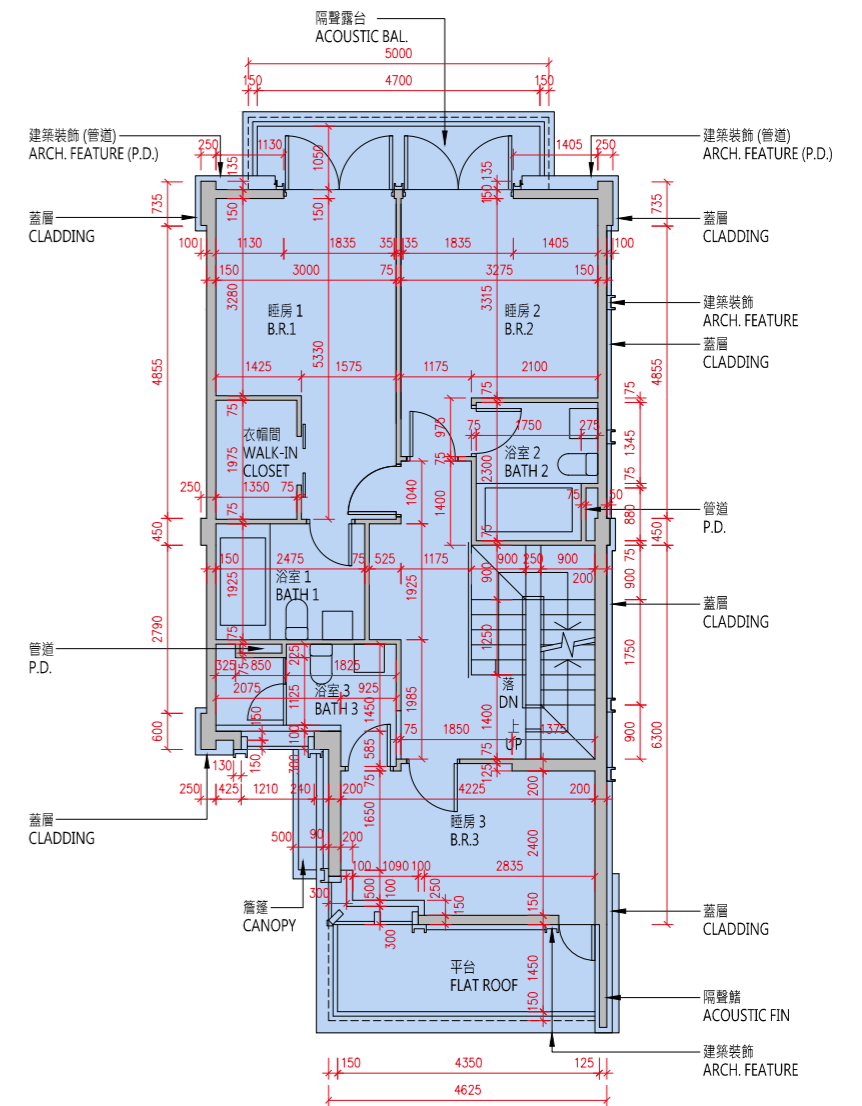

1樓平面圖
1/F Floor Plan

比例 :0米/M 5米/M
Scale :

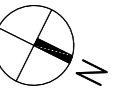

C8洋房
House C8

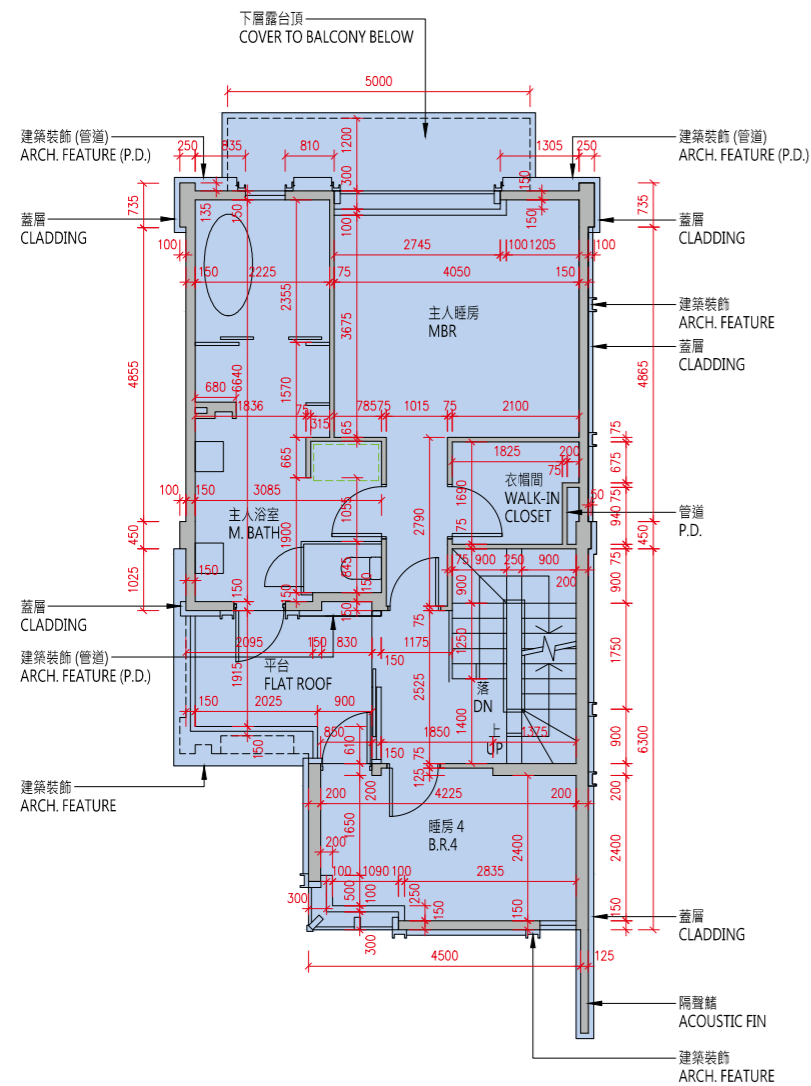
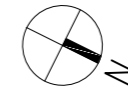

2樓平面圖
2/F Floor Plan

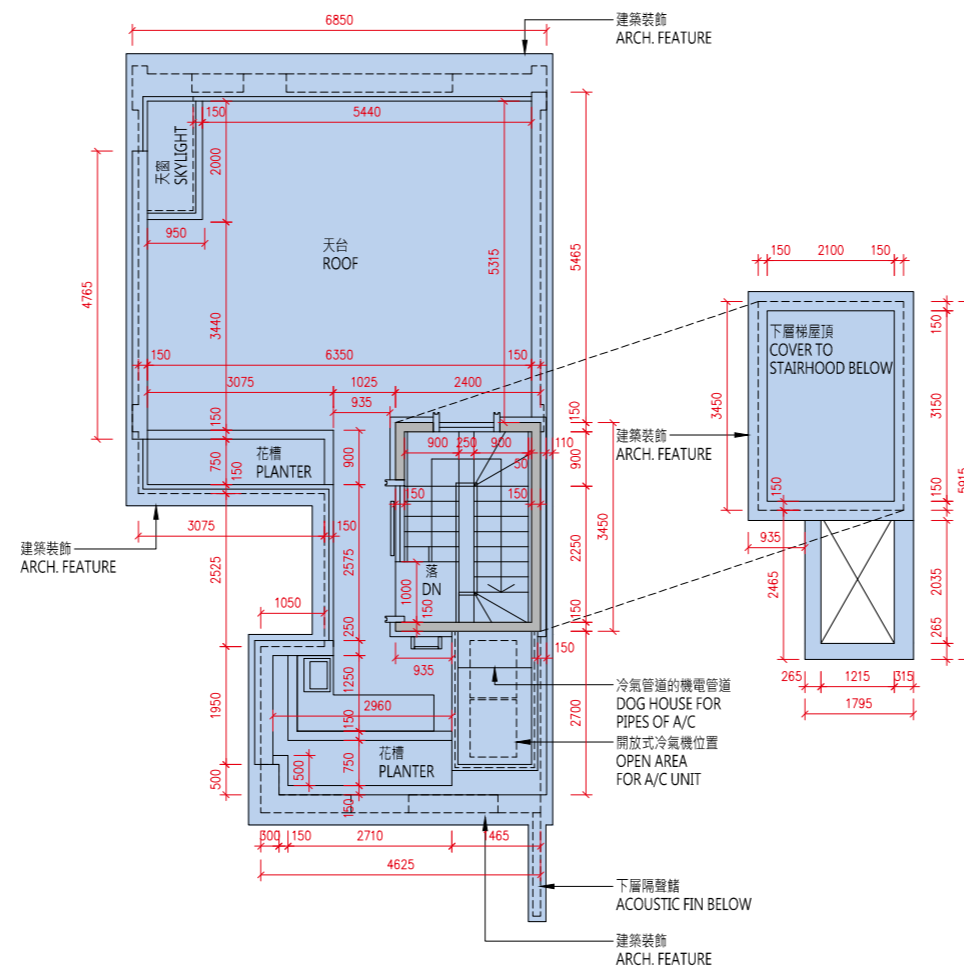

天台平面圖
Roof Floor Plan

比例：0米/M 5米/M
Scale :

樓層 Floor	地庫1樓 B1/F	地下 G/F	1樓 1/F	2樓 2/F	天台 Roof
層與層之間的高度 (毫米) Floor to Floor Height (mm)	4110, 4350	3750, 3970, 4000	3050, 3080, 3125, 3300	3500	N/A
樓板 (不包括灰泥) 的厚度 (毫米) Thickness of Floor Slab (excluding plaster) (mm)	200	150, 200	150, 200	150, 200	N/A

10 發展項目的住宅物業的樓面平面圖

FLOOR PLANS OF RESIDENTIAL PROPERTIES IN THE DEVELOPMENT

備註：

- (1) 批地文件特別條件第 8(d) 條規定：-
「(d) 在該地段已建成或擬建的住宅單位數目須不少於 515，並就本 (d) 分條而言：
 - (i) 一座擬作為單一家庭住宅的獨立屋、半獨立屋或排屋均被視為一個住宅單位；
 - (ii) 署長就獨立屋、半獨立屋或排屋是否構成或擬作為單一家庭住宅所作的決定將為最終決定，並對買方構成約束力；及
 - (iii) 署長就什麼構成一個住宅單位所作的決定將為最終決定，並對買方構成約束力。」
- (2) 公契及管理協議第 85 條規定：-
「管理人須在管理處備存一份由地政總署署長或任何其他不時替代其位的政府主管當局根據本公契附表三第 43 條所發出的同意的資料記錄，以供所有業主免費查閱及自費影印該資料記錄，並繳付合理費用。所有就此收取的費用一律撥入特別基金。」
- (3) 公契及管理協議附表三第 43 條規定：-
「43. 除非事先獲得地政總署署長或任何其他不時替代其位的政府主管當局的書面同意，否則任何業主不得進行或允許或容忍他人進行任何與住宅單位相關而可導致該住宅單位內部相連及通往任何毗連或毗鄰的住宅單位的工程，包括但不限於拆卸或更改任何分隔牆或任何樓板或天台樓板或任何間隔結構。而地政總署署長具有全權酌情給予同意或拒絕同意，倘若給予同意，業主須遵從地政總署署長按其全權酌情附加的任何條款及條件（包括支付費用）。」
- (4) 發展項目內所提供的住宅單位總數目為 590。
- (5) 平面圖所列的數字為以毫米標示之建築結構尺寸。
- (6) 因住宅物業的較高樓層的結構牆的厚度遞減，較高樓層的內部面積，一般比較低樓層的內部面積稍大。
- (7) 請參閱本售樓說明書第 20 頁為住宅物業樓面平面圖而設之備註及名詞及簡稱的圖例。

Notes:

- (1) Special Condition No. (8)(d) of the Land Grant stipulates that: -
“(d) the total number of residential units erected or to be erected on the lot shall not be less than 515, and for the purposes of this sub-clause (d):
 - (i) a detached, semi-detached or terraced house which is intended for use as a single family residence shall be regarded as a residential unit;
 - (ii) the decision of the Director as to whether a detached, semi-detached or terraced house constitutes or is intended for use as a single family residence shall be final and binding on the Purchaser; and
 - (iii) the decision of the Director as to what constitutes a residential unit shall be final and binding on the Purchaser.”
- (2) Clause 85 of the Deed of Mutual Covenant incorporating Management Agreement stipulates that: -
“85. The Manager shall deposit in the management office the record provided by the Director of Lands or any other Government authority in place of him from time to time of the information relating to the consent given under Clause 43 of the Third Schedule hereto for inspection by all Owners free of charge and taking copies at their own expense and on payment of a reasonable charge. All charges received shall be credited to the Special Fund.”
- (3) Clause 43 of the Third Schedule to the Deed of Mutual Covenant incorporating Management Agreement stipulates that: -
“43. No Owner shall carry out or permit or suffer to be carried out any works in connection with any Residential Unit, including but not limited to demolition or alteration of any partition wall or any floor or roof slab or any partition structure, which will result in such Residential Unit being internally linked to and accessible from any adjoining or adjacent Residential Unit, except with the prior written consent of the Director of Lands or any other Government authority in place of him from time to time, which consent may be given or withheld at his absolute discretion and if given, may be subject to such terms and conditions (including payment of fees) as may be imposed by him at his absolute discretion.”
- (4) The total number of residential units provided in the development is 590.
- (5) The dimensions in floor plans are all structural dimensions in millimeter.
- (6) The internal areas of the residential properties on the upper floors will generally be slightly larger than those on the lower floors because of the reducing thickness of the structural walls on the upper floors.
- (7) Please refer to page 20 of this sales brochure for the remarks and legends of the terms and abbreviations for the floor plans of residential properties.

10 發展項目的住宅物業的樓面平面圖 FLOOR PLANS OF RESIDENTIAL PROPERTIES IN THE DEVELOPMENT

第1座 2樓平面圖 Tower 1 2/F Floor Plan

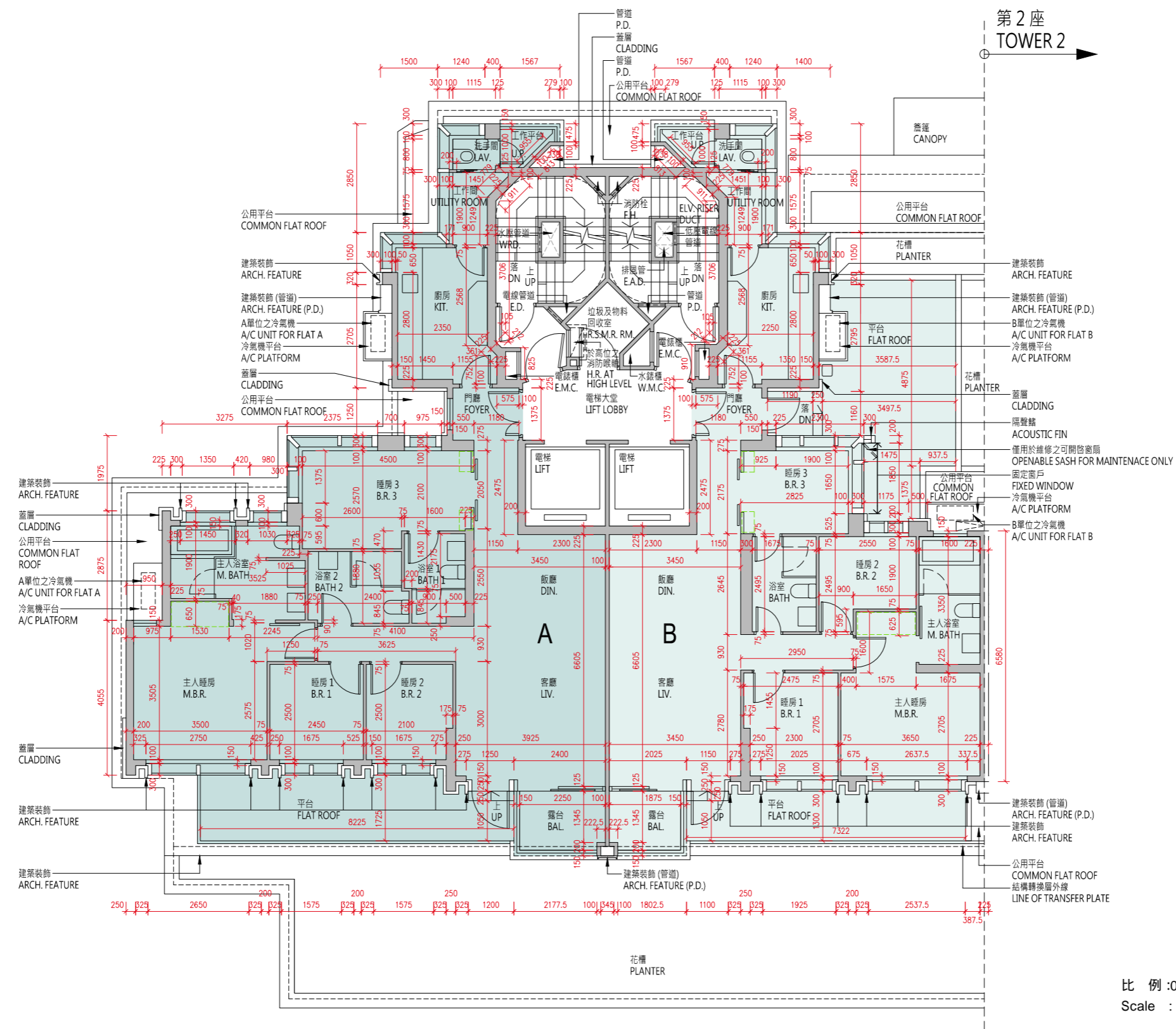

每個住宅物業 Each Residential Property	單位 Flat		
	樓層 Floor	A	B
層與層之間的高度 (毫米) Floor to Floor Height (mm)	2 樓 2/F	3450	3450
樓板 (不包括灰泥) 的厚度 (毫米) Thickness of Floor Slab (excluding plaster) (mm)	2/F	150, 200	150, 200

10 發展項目的住宅物業的樓面平面圖

FLOOR PLANS OF RESIDENTIAL PROPERTIES IN THE DEVELOPMENT

備註：

- (1) 批地文件特別條件第 8(d) 條規定：-
「(d) 在該地段已建成或擬建的住宅單位數目須不少於 515，並就本 (d) 分條而言：
 - (i) 一座擬作為單一家庭住宅的獨立屋、半獨立屋或排屋均被視為一個住宅單位；
 - (ii) 署長就獨立屋、半獨立屋或排屋是否構成或擬作為單一家庭住宅所作的決定將為最終決定，並對買方構成約束力；及
 - (iii) 署長就什麼構成一個住宅單位所作的決定將為最終決定，並對買方構成約束力。」
- (2) 公契及管理協議第 85 條規定：-
「管理人須在管理處備存一份由地政總署署長或任何其他不時替代其位的政府主管當局根據本公契附表三第 43 條所發出的同意的資料記錄，以供所有業主免費查閱及自費影印該資料記錄，並繳付合理費用。所有就此收取的費用一律撥入特別基金。」
- (3) 公契及管理協議附表三第 43 條規定：-
「43. 除非事先獲得地政總署署長或任何其他不時替代其位的政府主管當局的書面同意，否則任何業主不得進行或允許或容忍他人進行任何與住宅單位相關而可導致該住宅單位內部相連及通往任何毗連或毗鄰的住宅單位的工程，包括但不限於拆卸或更改任何分隔牆或任何樓板或天台樓板或任何間隔結構。而地政總署署長具有全權酌情給予同意或拒絕同意，倘若給予同意，業主須遵從地政總署署長按其全權酌情附加的任何條款及條件（包括支付費用）。」
- (4) 發展項目內所提供的住宅單位總數目為 590。
- (5) 平面圖所列的數字為以毫米標示之建築結構尺寸。
- (6) 因住宅物業的較高樓層的結構牆的厚度遞減，較高樓層的內部面積，一般比較低樓層的內部面積稍大。
- (7) 請參閱本售樓說明書第 20 頁為住宅物業樓面平面圖而設之備註及名詞及簡稱的圖例。

Notes:

- (1) Special Condition No. (8)(d) of the Land Grant stipulates that: -
“(d) the total number of residential units erected or to be erected on the lot shall not be less than 515, and for the purposes of this sub-clause (d):
 - (i) a detached, semi-detached or terraced house which is intended for use as a single family residence shall be regarded as a residential unit;
 - (ii) the decision of the Director as to whether a detached, semi-detached or terraced house constitutes or is intended for use as a single family residence shall be final and binding on the Purchaser; and
 - (iii) the decision of the Director as to what constitutes a residential unit shall be final and binding on the Purchaser.”
- (2) Clause 85 of the Deed of Mutual Covenant incorporating Management Agreement stipulates that: -
“85. The Manager shall deposit in the management office the record provided by the Director of Lands or any other Government authority in place of him from time to time of the information relating to the consent given under Clause 43 of the Third Schedule hereto for inspection by all Owners free of charge and taking copies at their own expense and on payment of a reasonable charge. All charges received shall be credited to the Special Fund.”
- (3) Clause 43 of the Third Schedule to the Deed of Mutual Covenant incorporating Management Agreement stipulates that: -
“43. No Owner shall carry out or permit or suffer to be carried out any works in connection with any Residential Unit, including but not limited to demolition or alteration of any partition wall or any floor or roof slab or any partition structure, which will result in such Residential Unit being internally linked to and accessible from any adjoining or adjacent Residential Unit, except with the prior written consent of the Director of Lands or any other Government authority in place of him from time to time, which consent may be given or withheld at his absolute discretion and if given, may be subject to such terms and conditions (including payment of fees) as may be imposed by him at his absolute discretion.”
- (4) The total number of residential units provided in the development is 590.
- (5) The dimensions in floor plans are all structural dimensions in millimeter.
- (6) The internal areas of the residential properties on the upper floors will generally be slightly larger than those on the lower floors because of the reducing thickness of the structural walls on the upper floors.
- (7) Please refer to page 20 of this sales brochure for the remarks and legends of the terms and abbreviations for the floor plans of residential properties.

10 發展項目的住宅物業的樓面平面圖 FLOOR PLANS OF RESIDENTIAL PROPERTIES IN THE DEVELOPMENT

第1座 3樓、5樓至12樓平面圖
Tower 1 3/F, 5/F-12/F Floor Plan

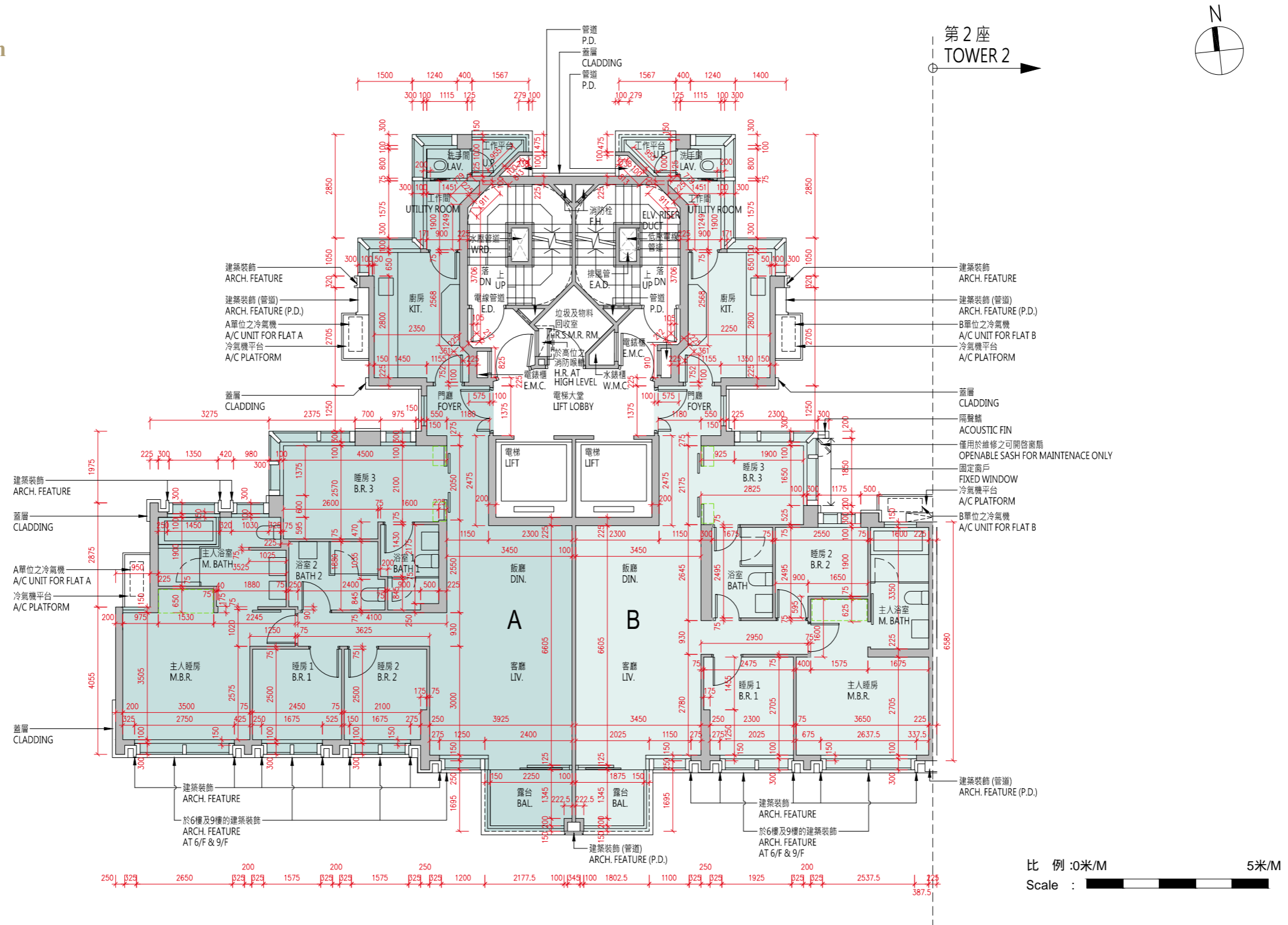

每個住宅物業 Each Residential Property	單位 Flat 樓層 Floor	A	B
層與層之間的高度 (毫米) Floor to Floor Height (mm)	3 樓、5 樓至 12 樓 3/F, 5/F-12/F	3450	3450
樓板 (不包括灰泥) 的厚度 (毫米) Thickness of Floor Slab (excluding plaster) (mm)		150, 200	150, 200

10 發展項目的住宅物業的樓面平面圖

FLOOR PLANS OF RESIDENTIAL PROPERTIES IN THE DEVELOPMENT

備註：

- (1) 批地文件特別條件第 8(d) 條規定：-
「(d) 在該地段已建成或擬建的住宅單位數目須不少於 515，並就本 (d) 分條而言：
 - (i) 一座擬作為單一家庭住宅的獨立屋、半獨立屋或排屋均被視為一個住宅單位；
 - (ii) 署長就獨立屋、半獨立屋或排屋是否構成或擬作為單一家庭住宅所作的決定將為最終決定，並對買方構成約束力；及
 - (iii) 署長就什麼構成一個住宅單位所作的決定將為最終決定，並對買方構成約束力。」
- (2) 公契及管理協議第 85 條規定：-
「管理人須在管理處備存一份由地政總署署長或任何其他不時替代其位的政府主管當局根據本公契附表三第 43 條所發出的同意的資料記錄，以供所有業主免費查閱及自費影印該資料記錄，並繳付合理費用。所有就此收取的費用一律撥入特別基金。」
- (3) 公契及管理協議附表三第 43 條規定：-
「43. 除非事先獲得地政總署署長或任何其他不時替代其位的政府主管當局的書面同意，否則任何業主不得進行或允許或容忍他人進行任何與住宅單位相關而可導致該住宅單位內部相連及通往任何毗連或毗鄰的住宅單位的工程，包括但不限於拆卸或更改任何分隔牆或任何樓板或天台樓板或任何間隔結構。而地政總署署長具有全權酌情給予同意或拒絕同意，倘若給予同意，業主須遵從地政總署署長按其全權酌情附加的任何條款及條件 (包括支付費用)。」
- (4) 發展項目內所提供的住宅單位總數目為 590。
- (5) 平面圖所列的數字為以毫米標示之建築結構尺寸。
- (6) 因住宅物業的較高樓層的結構牆的厚度遞減，較高樓層的內部面積，一般比較低樓層的內部面積稍大。
- (7) 請參閱本售樓說明書第 20 頁為住宅物業樓面平面圖而設之備註及名詞及簡稱的圖例。

Notes:

- (1) Special Condition No. (8)(d) of the Land Grant stipulates that: -
“(d) the total number of residential units erected or to be erected on the lot shall not be less than 515, and for the purposes of this sub-clause (d):
 - (i) a detached, semi-detached or terraced house which is intended for use as a single family residence shall be regarded as a residential unit;
 - (ii) the decision of the Director as to whether a detached, semi-detached or terraced house constitutes or is intended for use as a single family residence shall be final and binding on the Purchaser; and
 - (iii) the decision of the Director as to what constitutes a residential unit shall be final and binding on the Purchaser.”
- (2) Clause 85 of the Deed of Mutual Covenant incorporating Management Agreement stipulates that: -
“85. The Manager shall deposit in the management office the record provided by the Director of Lands or any other Government authority in place of him from time to time of the information relating to the consent given under Clause 43 of the Third Schedule hereto for inspection by all Owners free of charge and taking copies at their own expense and on payment of a reasonable charge. All charges received shall be credited to the Special Fund.”
- (3) Clause 43 of the Third Schedule to the Deed of Mutual Covenant incorporating Management Agreement stipulates that: -
“43. No Owner shall carry out or permit or suffer to be carried out any works in connection with any Residential Unit, including but not limited to demolition or alteration of any partition wall or any floor or roof slab or any partition structure, which will result in such Residential Unit being internally linked to and accessible from any adjoining or adjacent Residential Unit, except with the prior written consent of the Director of Lands or any other Government authority in place of him from time to time, which consent may be given or withheld at his absolute discretion and if given, may be subject to such terms and conditions (including payment of fees) as may be imposed by him at his absolute discretion.”
- (4) The total number of residential units provided in the development is 590.
- (5) The dimensions in floor plans are all structural dimensions in millimeter.
- (6) The internal areas of the residential properties on the upper floors will generally be slightly larger than those on the lower floors because of the reducing thickness of the structural walls on the upper floors.
- (7) Please refer to page 20 of this sales brochure for the remarks and legends of the terms and abbreviations for the floor plans of residential properties.

10 發展項目的住宅物業的樓面平面圖 FLOOR PLANS OF RESIDENTIAL PROPERTIES IN THE DEVELOPMENT

第1座 15樓至23樓、25樓至27樓平面圖 Tower 1 15/F-23/F, 25/F-27/F Floor Plan

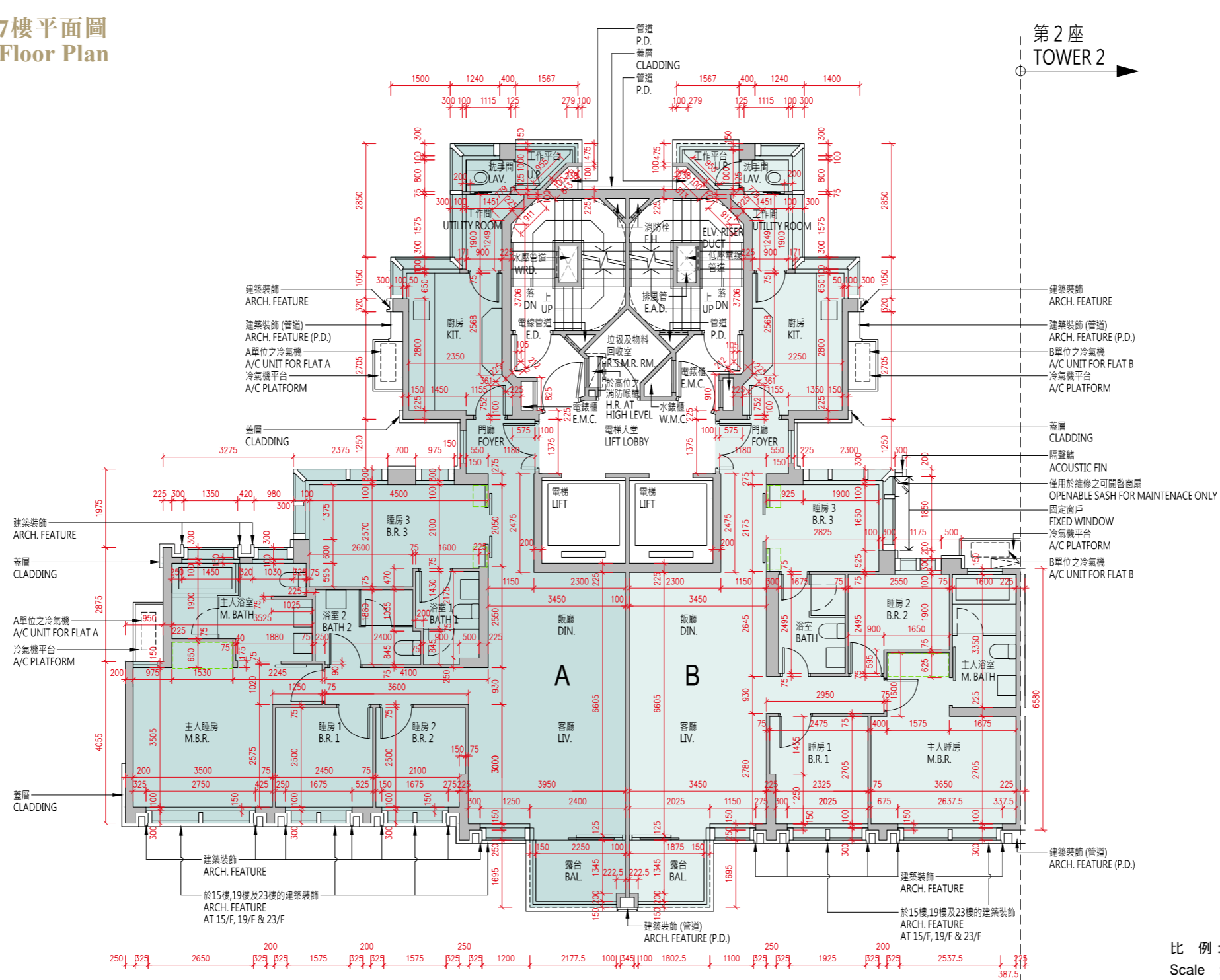

每個住宅物業 Each Residential Property	單位 Flat		
	樓層 Floor	單位 Flat	
層與層之間的高度 (毫米) Floor to Floor Height (mm)	15 樓至 23 樓、 25 樓至 26 樓 15/F-23/F, 25/F-26/F	A	B
樓板 (不包括灰泥) 的厚度 (毫米) Thickness of Floor Slab (excluding plaster) (mm)		3450	3450
		150, 200	150, 200

每個住宅物業 Each Residential Property	單位 Flat		
	樓層 Floor	單位 Flat	
層與層之間的高度 (毫米) Floor to Floor Height (mm)	27 樓 27/F	A	B
樓板 (不包括灰泥) 的厚度 (毫米) Thickness of Floor Slab (excluding plaster) (mm)		3150, 3180, 3400, 3500	3100, 3400, 3500
		150, 200, 250	150, 250

10 發展項目的住宅物業的樓面平面圖

FLOOR PLANS OF RESIDENTIAL PROPERTIES IN THE DEVELOPMENT

備註：

- (1) 批地文件特別條件第 8(d) 條規定：-
「(d) 在該地段已建成或擬建的住宅單位數目須不少於 515，並就本 (d) 分條而言：
 - (i) 一座擬作為單一家庭住宅的獨立屋、半獨立屋或排屋均被視為一個住宅單位；
 - (ii) 署長就獨立屋、半獨立屋或排屋是否構成或擬作為單一家庭住宅所作的決定將為最終決定，並對買方構成約束力；及
 - (iii) 署長就什麼構成一個住宅單位所作的決定將為最終決定，並對買方構成約束力。」
- (2) 公契及管理協議第 85 條規定：-
「管理人須在管理處備存一份由地政總署署長或任何其他不時替代其位的政府主管當局根據本公契附表三第 43 條所發出的同意的資料記錄，以供所有業主免費查閱及自費影印該資料記錄，並繳付合理費用。所有就此收取的費用一律撥入特別基金。」
- (3) 公契及管理協議附表三第 43 條規定：-
「43. 除非事先獲得地政總署署長或任何其他不時替代其位的政府主管當局的書面同意，否則任何業主不得進行或允許或容忍他人進行任何與住宅單位相關而可導致該住宅單位內部相連及通往任何毗連或毗鄰的住宅單位的工程，包括但不限於拆卸或更改任何分隔牆或任何樓板或天台樓板或任何間隔結構。而地政總署署長具有全權酌情給予同意或拒絕同意，倘若給予同意，業主須遵從地政總署署長按其全權酌情附加的任何條款及條件（包括支付費用）。」
- (4) 發展項目內所提供的住宅單位總數目為 590。
- (5) 平面圖所列的數字為以毫米標示之建築結構尺寸。
- (6) 因住宅物業的較高樓層的結構牆的厚度遞減，較高樓層的內部面積，一般比較低樓層的內部面積稍大。
- (7) 請參閱本售樓說明書第 20 頁為住宅物業樓面平面圖而設之備註及名詞及簡稱的圖例。

Notes:

- (1) Special Condition No. (8)(d) of the Land Grant stipulates that: -
“(d) the total number of residential units erected or to be erected on the lot shall not be less than 515, and for the purposes of this sub-clause (d):
 - (i) a detached, semi-detached or terraced house which is intended for use as a single family residence shall be regarded as a residential unit;
 - (ii) the decision of the Director as to whether a detached, semi-detached or terraced house constitutes or is intended for use as a single family residence shall be final and binding on the Purchaser; and
 - (iii) the decision of the Director as to what constitutes a residential unit shall be final and binding on the Purchaser.”
- (2) Clause 85 of the Deed of Mutual Covenant incorporating Management Agreement stipulates that: -
“85. The Manager shall deposit in the management office the record provided by the Director of Lands or any other Government authority in place of him from time to time of the information relating to the consent given under Clause 43 of the Third Schedule hereto for inspection by all Owners free of charge and taking copies at their own expense and on payment of a reasonable charge. All charges received shall be credited to the Special Fund.”
- (3) Clause 43 of the Third Schedule to the Deed of Mutual Covenant incorporating Management Agreement stipulates that: -
“43. No Owner shall carry out or permit or suffer to be carried out any works in connection with any Residential Unit, including but not limited to demolition or alteration of any partition wall or any floor or roof slab or any partition structure, which will result in such Residential Unit being internally linked to and accessible from any adjoining or adjacent Residential Unit, except with the prior written consent of the Director of Lands or any other Government authority in place of him from time to time, which consent may be given or withheld at his absolute discretion and if given, may be subject to such terms and conditions (including payment of fees) as may be imposed by him at his absolute discretion.”
- (4) The total number of residential units provided in the development is 590.
- (5) The dimensions in floor plans are all structural dimensions in millimeter.
- (6) The internal areas of the residential properties on the upper floors will generally be slightly larger than those on the lower floors because of the reducing thickness of the structural walls on the upper floors.
- (7) Please refer to page 20 of this sales brochure for the remarks and legends of the terms and abbreviations for the floor plans of residential properties.

第1座 28樓平面圖
Tower 1 28/F Floor Plan

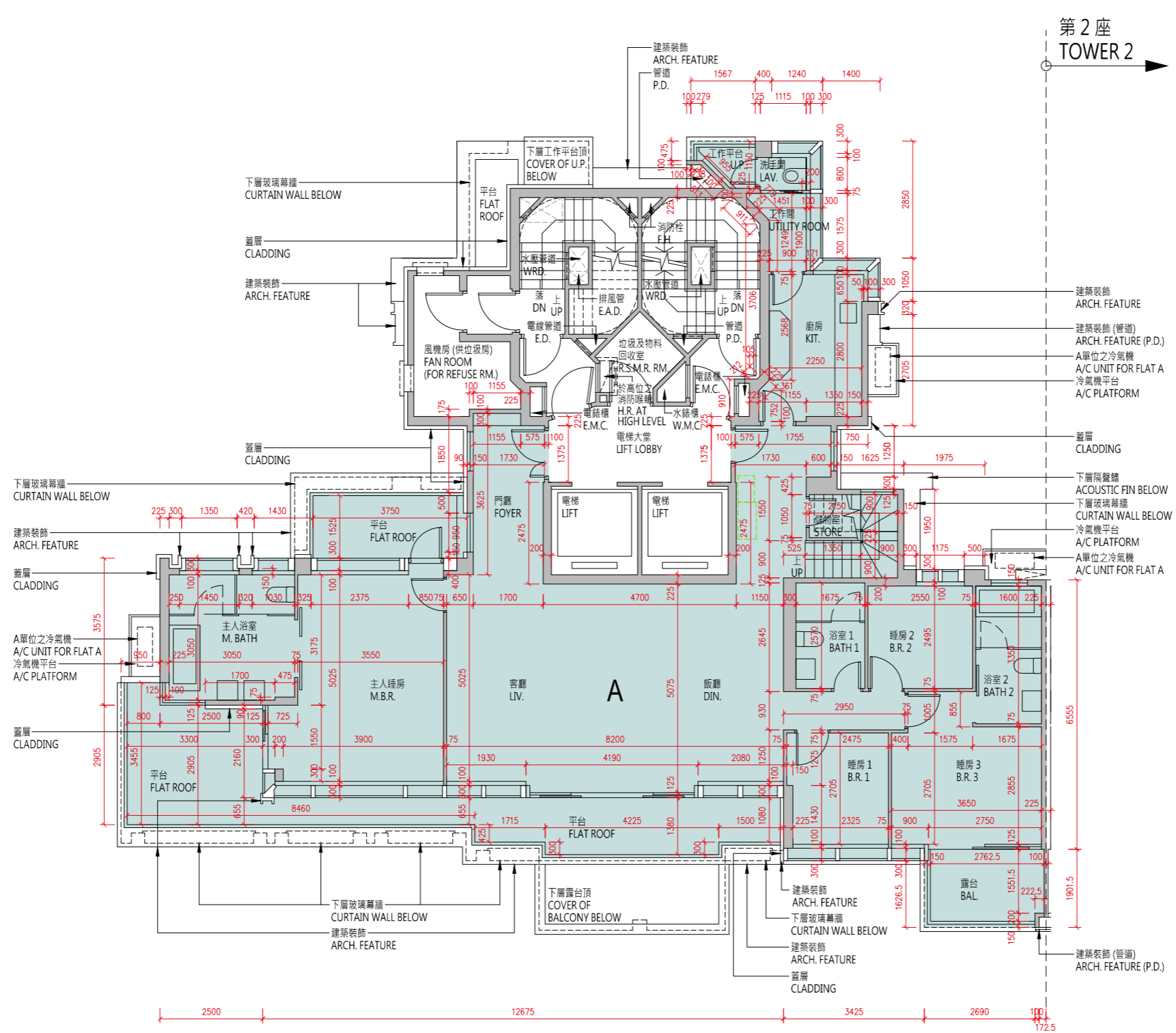

樓層 Floor	28樓 28 / F
層與層之間的高度 (毫米) Floor to Floor Height (mm)	3500
樓板 (不包括灰泥) 的厚度 (毫米) Thickness of Floor Slab (excluding plaster) (mm)	150, 200

10 發展項目的住宅物業的樓面平面圖

FLOOR PLANS OF RESIDENTIAL PROPERTIES IN THE DEVELOPMENT

備註：

- (1) 批地文件特別條件第 8(d) 條規定：-
「(d) 在該地段已建成或擬建的住宅單位數目須不少於 515，並就本 (d) 分條而言：
 - (i) 一座擬作為單一家庭住宅的獨立屋、半獨立屋或排屋均被視為一個住宅單位；
 - (ii) 署長就獨立屋、半獨立屋或排屋是否構成或擬作為單一家庭住宅所作的決定將為最終決定，並對買方構成約束力；及
 - (iii) 署長就什麼構成一個住宅單位所作的決定將為最終決定，並對買方構成約束力。」
- (2) 公契及管理協議第 85 條規定：-
「管理人須在管理處備存一份由地政總署署長或任何其他不時替代其位的政府主管當局根據本公契附表三第 43 條所發出的同意的資料記錄，以供所有業主免費查閱及自費影印該資料記錄，並繳付合理費用。所有就此收取的費用一律撥入特別基金。」
- (3) 公契及管理協議附表三第 43 條規定：-
「43. 除非事先獲得地政總署署長或任何其他不時替代其位的政府主管當局的書面同意，否則任何業主不得進行或允許或容忍他人進行任何與住宅單位相關而可導致該住宅單位內部相連及通往任何毗連或毗鄰的住宅單位的工程，包括但不限於拆卸或更改任何分隔牆或任何樓板或天台樓板或任何間隔結構。而地政總署署長具有全權酌情給予同意或拒絕同意，倘若給予同意，業主須遵從地政總署署長按其全權酌情附加的任何條款及條件 (包括支付費用)。」
- (4) 發展項目內所提供的住宅單位總數目為 590。
- (5) 平面圖所列的數字為以毫米標示之建築結構尺寸。
- (6) 因住宅物業的較高樓層的結構牆的厚度遞減，較高樓層的內部面積，一般比較低樓層的內部面積稍大。
- (7) 請參閱本售樓說明書第 20 頁為住宅物業樓面平面圖而設之備註及名詞及簡稱的圖例。

Notes:

- (1) Special Condition No. (8)(d) of the Land Grant stipulates that: -
“(d) the total number of residential units erected or to be erected on the lot shall not be less than 515, and for the purposes of this sub-clause (d):
 - (i) a detached, semi-detached or terraced house which is intended for use as a single family residence shall be regarded as a residential unit;
 - (ii) the decision of the Director as to whether a detached, semi-detached or terraced house constitutes or is intended for use as a single family residence shall be final and binding on the Purchaser; and
 - (iii) the decision of the Director as to what constitutes a residential unit shall be final and binding on the Purchaser.”
- (2) Clause 85 of the Deed of Mutual Covenant incorporating Management Agreement stipulates that: -
“85. The Manager shall deposit in the management office the record provided by the Director of Lands or any other Government authority in place of him from time to time of the information relating to the consent given under Clause 43 of the Third Schedule hereto for inspection by all Owners free of charge and taking copies at their own expense and on payment of a reasonable charge. All charges received shall be credited to the Special Fund.”
- (3) Clause 43 of the Third Schedule to the Deed of Mutual Covenant incorporating Management Agreement stipulates that: -
“43. No Owner shall carry out or permit or suffer to be carried out any works in connection with any Residential Unit, including but not limited to demolition or alteration of any partition wall or any floor or roof slab or any partition structure, which will result in such Residential Unit being internally linked to and accessible from any adjoining or adjacent Residential Unit, except with the prior written consent of the Director of Lands or any other Government authority in place of him from time to time, which consent may be given or withheld at his absolute discretion and if given, may be subject to such terms and conditions (including payment of fees) as may be imposed by him at his absolute discretion.”
- (4) The total number of residential units provided in the development is 590.
- (5) The dimensions in floor plans are all structural dimensions in millimeter.
- (6) The internal areas of the residential properties on the upper floors will generally be slightly larger than those on the lower floors because of the reducing thickness of the structural walls on the upper floors.
- (7) Please refer to page 20 of this sales brochure for the remarks and legends of the terms and abbreviations for the floor plans of residential properties.

第1座 天台平面圖
Tower 1 Roof Floor Plan

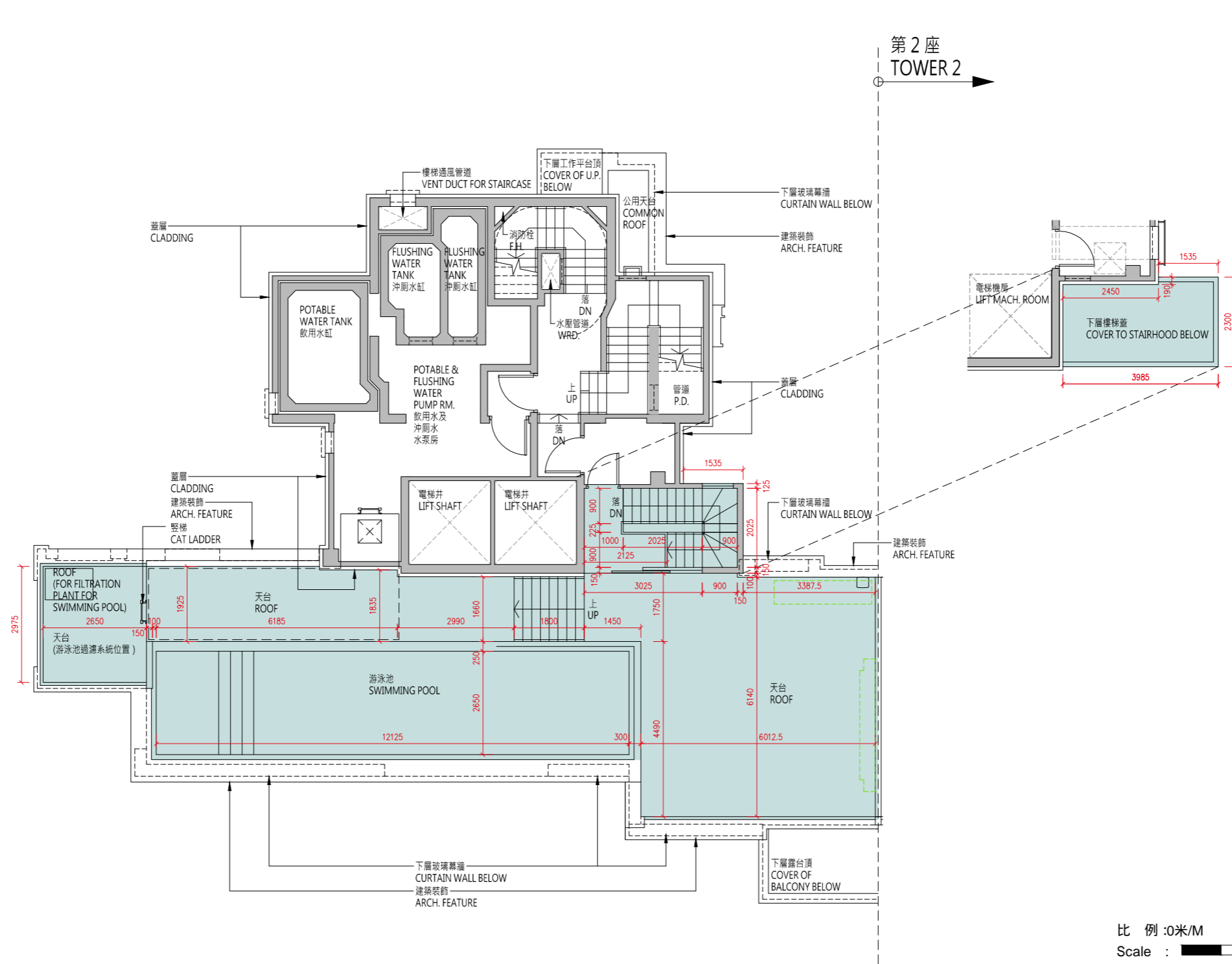

樓層 Floor	天台 Roof
層與層之間的高度 (毫米) Floor to Floor Height (mm)	N/A
樓板 (不包括灰泥) 的厚度 (毫米) Thickness of Floor Slab (excluding plaster) (mm)	N/A

10 發展項目的住宅物業的樓面平面圖

FLOOR PLANS OF RESIDENTIAL PROPERTIES IN THE DEVELOPMENT

備註：

- (1) 批地文件特別條件第 8(d) 條規定：-
「(d) 在該地段已建成或擬建的住宅單位數目須不少於 515，並就本 (d) 分條而言：
 - (i) 一座擬作為單一家庭住宅的獨立屋、半獨立屋或排屋均被視為一個住宅單位；
 - (ii) 署長就獨立屋、半獨立屋或排屋是否構成或擬作為單一家庭住宅所作的決定將為最終決定，並對買方構成約束力；及
 - (iii) 署長就什麼構成一個住宅單位所作的決定將為最終決定，並對買方構成約束力。」
- (2) 公契及管理協議第 85 條規定：-
「管理人須在管理處備存一份由地政總署署長或任何其他不時替代其位的政府主管當局根據本公契附表三第 43 條所發出的同意的資料記錄，以供所有業主免費查閱及自費影印該資料記錄，並繳付合理費用。所有就此收取的費用一律撥入特別基金。」
- (3) 公契及管理協議附表三第 43 條規定：-
「43. 除非事先獲得地政總署署長或任何其他不時替代其位的政府主管當局的書面同意，否則任何業主不得進行或允許或容忍他人進行任何與住宅單位相關而可導致該住宅單位內部相連及通往任何毗連或毗鄰的住宅單位的工程，包括但不限於拆卸或更改任何分隔牆或任何樓板或天台樓板或任何間隔結構。而地政總署署長具有全權酌情給予同意或拒絕同意，倘若給予同意，業主須遵從地政總署署長按其全權酌情附加的任何條款及條件（包括支付費用）。」
- (4) 發展項目內所提供的住宅單位總數目為 590。
- (5) 平面圖所列的數字為以毫米標示之建築結構尺寸。
- (6) 因住宅物業的較高樓層的結構牆的厚度遞減，較高樓層的內部面積，一般比較低樓層的內部面積稍大。
- (7) 請參閱本售樓說明書第 20 頁為住宅物業樓面平面圖而設之備註及名詞及簡稱的圖例。

Notes:

- (1) Special Condition No. (8)(d) of the Land Grant stipulates that: -
“(d) the total number of residential units erected or to be erected on the lot shall not be less than 515, and for the purposes of this sub-clause (d):
 - (i) a detached, semi-detached or terraced house which is intended for use as a single family residence shall be regarded as a residential unit;
 - (ii) the decision of the Director as to whether a detached, semi-detached or terraced house constitutes or is intended for use as a single family residence shall be final and binding on the Purchaser; and
 - (iii) the decision of the Director as to what constitutes a residential unit shall be final and binding on the Purchaser.”
- (2) Clause 85 of the Deed of Mutual Covenant incorporating Management Agreement stipulates that: -
“85. The Manager shall deposit in the management office the record provided by the Director of Lands or any other Government authority in place of him from time to time of the information relating to the consent given under Clause 43 of the Third Schedule hereto for inspection by all Owners free of charge and taking copies at their own expense and on payment of a reasonable charge. All charges received shall be credited to the Special Fund.”
- (3) Clause 43 of the Third Schedule to the Deed of Mutual Covenant incorporating Management Agreement stipulates that: -
“43. No Owner shall carry out or permit or suffer to be carried out any works in connection with any Residential Unit, including but not limited to demolition or alteration of any partition wall or any floor or roof slab or any partition structure, which will result in such Residential Unit being internally linked to and accessible from any adjoining or adjacent Residential Unit, except with the prior written consent of the Director of Lands or any other Government authority in place of him from time to time, which consent may be given or withheld at his absolute discretion and if given, may be subject to such terms and conditions (including payment of fees) as may be imposed by him at his absolute discretion.”
- (4) The total number of residential units provided in the development is 590.
- (5) The dimensions in floor plans are all structural dimensions in millimeter.
- (6) The internal areas of the residential properties on the upper floors will generally be slightly larger than those on the lower floors because of the reducing thickness of the structural walls on the upper floors.
- (7) Please refer to page 20 of this sales brochure for the remarks and legends of the terms and abbreviations for the floor plans of residential properties.

10 發展項目的住宅物業的樓面平面圖 FLOOR PLANS OF RESIDENTIAL PROPERTIES IN THE DEVELOPMENT

第2座 2樓平面圖
Tower 2 2/F Floor Plan

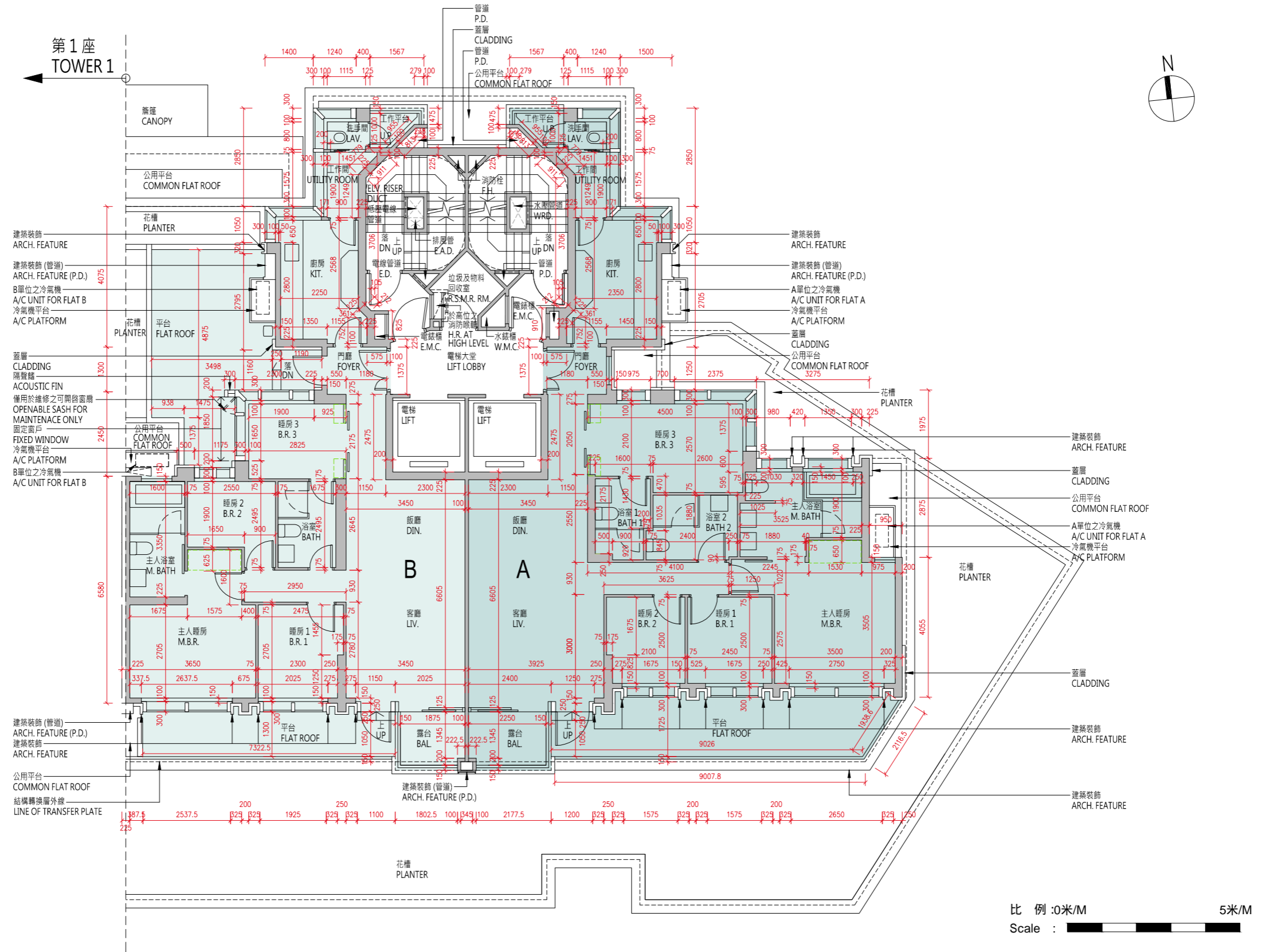

每個住宅物業 Each Residential Property	單位 Flat		
	樓層 Floor	A	B
層與層之間的高度 (毫米) Floor to Floor Height (mm)	2 樓 2/F	3450	3450
樓板 (不包括灰泥) 的厚度 (毫米) Thickness of Floor Slab (excluding plaster) (mm)		150, 200	150, 200

10 發展項目的住宅物業的樓面平面圖

FLOOR PLANS OF RESIDENTIAL PROPERTIES IN THE DEVELOPMENT

備註：

- (1) 批地文件特別條件第 8(d) 條規定：-
「(d) 在該地段已建成或擬建的住宅單位數目須不少於 515，並就本 (d) 分條而言：
 - (i) 一座擬作為單一家庭住宅的獨立屋、半獨立屋或排屋均被視為一個住宅單位；
 - (ii) 署長就獨立屋、半獨立屋或排屋是否構成或擬作為單一家庭住宅所作的決定將為最終決定，並對買方構成約束力；及
 - (iii) 署長就什麼構成一個住宅單位所作的決定將為最終決定，並對買方構成約束力。」
- (2) 公契及管理協議第 85 條規定：-
「管理人須在管理處備存一份由地政總署署長或任何其他不時替代其位的政府主管當局根據本公契附表三第 43 條所發出的同意的資料記錄，以供所有業主免費查閱及自費影印該資料記錄，並繳付合理費用。所有就此收取的費用一律撥入特別基金。」
- (3) 公契及管理協議附表三第 43 條規定：-
「43. 除非事先獲得地政總署署長或任何其他不時替代其位的政府主管當局的書面同意，否則任何業主不得進行或允許或容忍他人進行任何與住宅單位相關而可導致該住宅單位內部相連及通往任何毗連或毗鄰的住宅單位的工程，包括但不限於拆卸或更改任何分隔牆或任何樓板或天台樓板或任何間隔結構。而地政總署署長具有全權酌情給予同意或拒絕同意，倘若給予同意，業主須遵從地政總署署長按其全權酌情附加的任何條款及條件（包括支付費用）。」
- (4) 發展項目內所提供的住宅單位總數目為 590。
- (5) 平面圖所列的數字為以毫米標示之建築結構尺寸。
- (6) 因住宅物業的較高樓層的結構牆的厚度遞減，較高樓層的內部面積，一般比較低樓層的內部面積稍大。
- (7) 請參閱本售樓說明書第 20 頁為住宅物業樓面平面圖而設之備註及名詞及簡稱的圖例。

Notes:

- (1) Special Condition No. (8)(d) of the Land Grant stipulates that: -
“(d) the total number of residential units erected or to be erected on the lot shall not be less than 515, and for the purposes of this sub-clause (d):
 - (i) a detached, semi-detached or terraced house which is intended for use as a single family residence shall be regarded as a residential unit;
 - (ii) the decision of the Director as to whether a detached, semi-detached or terraced house constitutes or is intended for use as a single family residence shall be final and binding on the Purchaser; and
 - (iii) the decision of the Director as to what constitutes a residential unit shall be final and binding on the Purchaser.”
- (2) Clause 85 of the Deed of Mutual Covenant incorporating Management Agreement stipulates that: -
“85. The Manager shall deposit in the management office the record provided by the Director of Lands or any other Government authority in place of him from time to time of the information relating to the consent given under Clause 43 of the Third Schedule hereto for inspection by all Owners free of charge and taking copies at their own expense and on payment of a reasonable charge. All charges received shall be credited to the Special Fund.”
- (3) Clause 43 of the Third Schedule to the Deed of Mutual Covenant incorporating Management Agreement stipulates that: -
“43. No Owner shall carry out or permit or suffer to be carried out any works in connection with any Residential Unit, including but not limited to demolition or alteration of any partition wall or any floor or roof slab or any partition structure, which will result in such Residential Unit being internally linked to and accessible from any adjoining or adjacent Residential Unit, except with the prior written consent of the Director of Lands or any other Government authority in place of him from time to time, which consent may be given or withheld at his absolute discretion and if given, may be subject to such terms and conditions (including payment of fees) as may be imposed by him at his absolute discretion.”
- (4) The total number of residential units provided in the development is 590.
- (5) The dimensions in floor plans are all structural dimensions in millimeter.
- (6) The internal areas of the residential properties on the upper floors will generally be slightly larger than those on the lower floors because of the reducing thickness of the structural walls on the upper floors.
- (7) Please refer to page 20 of this sales brochure for the remarks and legends of the terms and abbreviations for the floor plans of residential properties.

10 發展項目的住宅物業的樓面平面圖 FLOOR PLANS OF RESIDENTIAL PROPERTIES IN THE DEVELOPMENT

第2座 3樓、5樓至12樓平面圖
Tower 2 3/F, 5/F-12/F Floor Plan

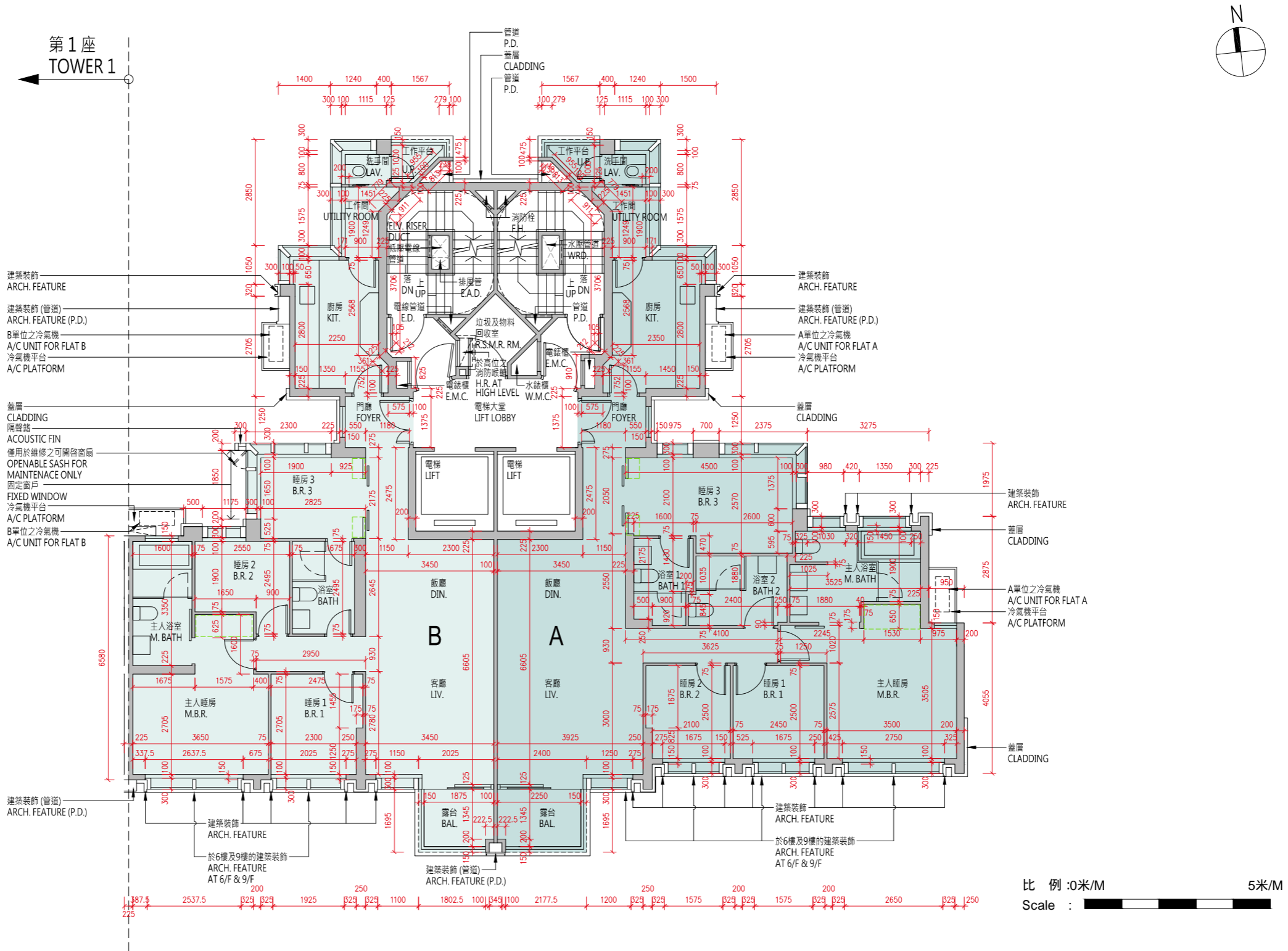

每個住宅物業 Each Residential Property	單位 Flat		
	樓層 Floor	A	B
層與層之間的高度 (毫米) Floor to Floor Height (mm)	3樓、5樓至12樓 3/F, 5/F-12/F	3450	3450
樓板 (不包括灰泥) 的厚度 (毫米) Thickness of Floor Slab (excluding plaster) (mm)		150, 200	150, 200

10 發展項目的住宅物業的樓面平面圖

FLOOR PLANS OF RESIDENTIAL PROPERTIES IN THE DEVELOPMENT

備註：

- (1) 批地文件特別條件第 8(d) 條規定：-
「(d) 在該地段已建成或擬建的住宅單位數目須不少於 515，並就本 (d) 分條而言：
 - (i) 一座擬作為單一家庭住宅的獨立屋、半獨立屋或排屋均被視為一個住宅單位；
 - (ii) 署長就獨立屋、半獨立屋或排屋是否構成或擬作為單一家庭住宅所作的決定將為最終決定，並對買方構成約束力；及
 - (iii) 署長就什麼構成一個住宅單位所作的決定將為最終決定，並對買方構成約束力。」
- (2) 公契及管理協議第 85 條規定：-
「管理人須在管理處備存一份由地政總署署長或任何其他不時替代其位的政府主管當局根據本公契附表三第 43 條所發出的同意的資料記錄，以供所有業主免費查閱及自費影印該資料記錄，並繳付合理費用。所有就此收取的費用一律撥入特別基金。」
- (3) 公契及管理協議附表三第 43 條規定：-
「43. 除非事先獲得地政總署署長或任何其他不時替代其位的政府主管當局的書面同意，否則任何業主不得進行或允許或容忍他人進行任何與住宅單位相關而可導致該住宅單位內部相連及通往任何毗連或毗鄰的住宅單位的工程，包括但不限於拆卸或更改任何分隔牆或任何樓板或天台樓板或任何間隔結構。而地政總署署長具有全權酌情給予同意或拒絕同意，倘若給予同意，業主須遵從地政總署署長按其全權酌情附加的任何條款及條件（包括支付費用）。」
- (4) 發展項目內所提供的住宅單位總數目為 590。
- (5) 平面圖所列的數字為以毫米標示之建築結構尺寸。
- (6) 因住宅物業的較高樓層的結構牆的厚度遞減，較高樓層的內部面積，一般比較低樓層的內部面積稍大。
- (7) 請參閱本售樓說明書第 20 頁為住宅物業樓面平面圖而設之備註及名詞及簡稱的圖例。

Notes:

- (1) Special Condition No. (8)(d) of the Land Grant stipulates that: -
“(d) the total number of residential units erected or to be erected on the lot shall not be less than 515, and for the purposes of this sub-clause (d):
 - (i) a detached, semi-detached or terraced house which is intended for use as a single family residence shall be regarded as a residential unit;
 - (ii) the decision of the Director as to whether a detached, semi-detached or terraced house constitutes or is intended for use as a single family residence shall be final and binding on the Purchaser; and
 - (iii) the decision of the Director as to what constitutes a residential unit shall be final and binding on the Purchaser.”
- (2) Clause 85 of the Deed of Mutual Covenant incorporating Management Agreement stipulates that: -
“85. The Manager shall deposit in the management office the record provided by the Director of Lands or any other Government authority in place of him from time to time of the information relating to the consent given under Clause 43 of the Third Schedule hereto for inspection by all Owners free of charge and taking copies at their own expense and on payment of a reasonable charge. All charges received shall be credited to the Special Fund.”
- (3) Clause 43 of the Third Schedule to the Deed of Mutual Covenant incorporating Management Agreement stipulates that: -
“43. No Owner shall carry out or permit or suffer to be carried out any works in connection with any Residential Unit, including but not limited to demolition or alteration of any partition wall or any floor or roof slab or any partition structure, which will result in such Residential Unit being internally linked to and accessible from any adjoining or adjacent Residential Unit, except with the prior written consent of the Director of Lands or any other Government authority in place of him from time to time, which consent may be given or withheld at his absolute discretion and if given, may be subject to such terms and conditions (including payment of fees) as may be imposed by him at his absolute discretion.”
- (4) The total number of residential units provided in the development is 590.
- (5) The dimensions in floor plans are all structural dimensions in millimeter.
- (6) The internal areas of the residential properties on the upper floors will generally be slightly larger than those on the lower floors because of the reducing thickness of the structural walls on the upper floors.
- (7) Please refer to page 20 of this sales brochure for the remarks and legends of the terms and abbreviations for the floor plans of residential properties.

10 發展項目的住宅物業的樓面平面圖 FLOOR PLANS OF RESIDENTIAL PROPERTIES IN THE DEVELOPMENT

第2座 15樓至23樓、25樓至27樓平面圖
Tower 2 15/F-23/F, 25/F-27/F Floor Plan

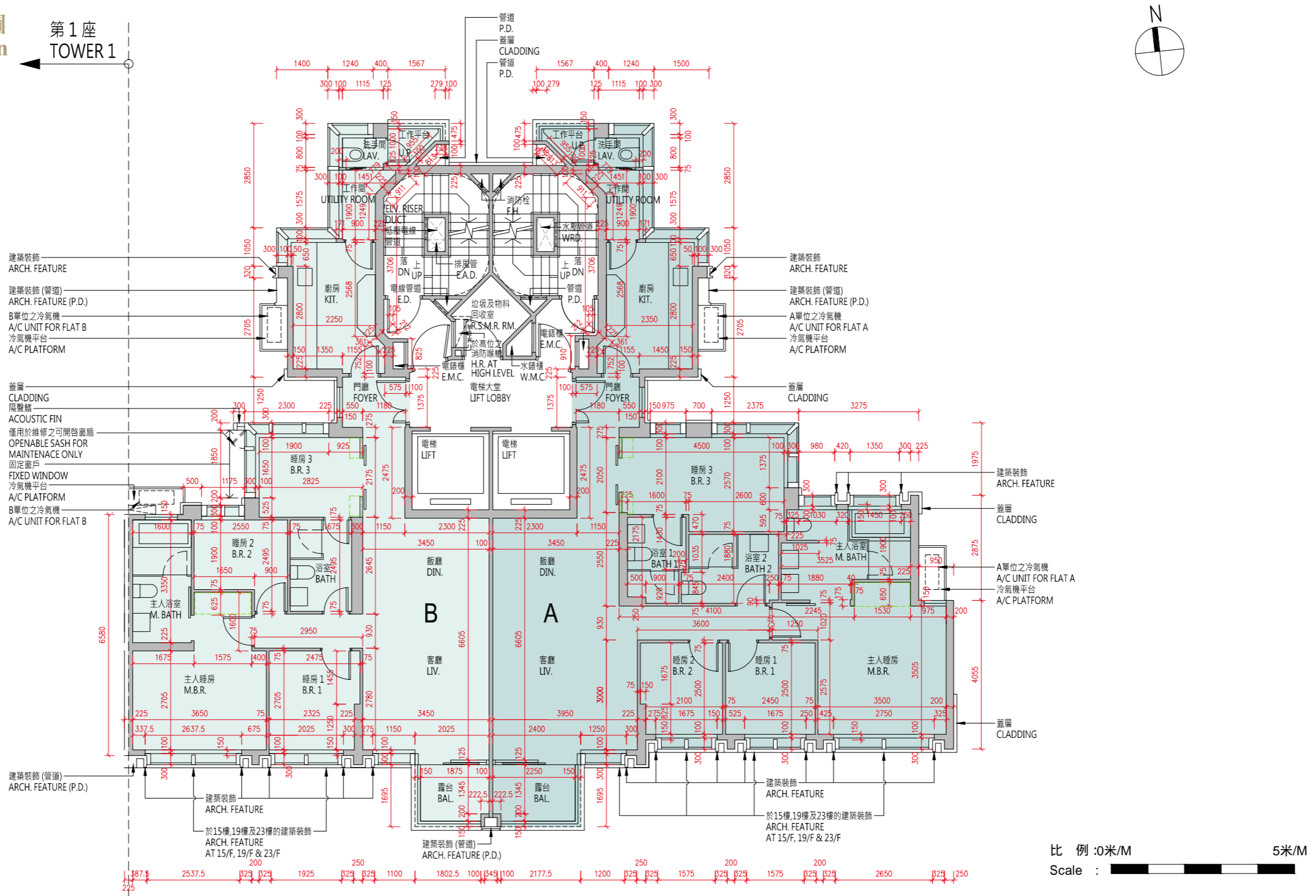

每個住宅物業 Each Residential Property	單位 Flat 樓層 Floor	單位 Flat	
		A	B
層與層之間的高度 (毫米) Floor to Floor Height (mm)	15樓至23樓、25樓至26樓 15/F-23/F, 25/F-26/F	3450	3450
樓板 (不包括灰泥) 的厚度 (毫米) Thickness of Floor Slab (excluding plaster) (mm)		150, 200	150, 200

每個住宅物業 Each Residential Property	單位 Flat 樓層 Floor	單位 Flat	
		A	B
層與層之間的高度 (毫米) Floor to Floor Height (mm)	27樓 27/F	3150, 3180, 3400, 3500	3100, 3400, 3500
樓板 (不包括灰泥) 的厚度 (毫米) Thickness of Floor Slab (excluding plaster) (mm)		150, 200, 250	150, 250

10 發展項目的住宅物業的樓面平面圖

FLOOR PLANS OF RESIDENTIAL PROPERTIES IN THE DEVELOPMENT

備註：

- (1) 批地文件特別條件第 8(d) 條規定：-
「(d) 在該地段已建成或擬建的住宅單位數目須不少於 515，並就本 (d) 分條而言：
 - (i) 一座擬作為單一家庭住宅的獨立屋、半獨立屋或排屋均被視為一個住宅單位；
 - (ii) 署長就獨立屋、半獨立屋或排屋是否構成或擬作為單一家庭住宅所作的決定將為最終決定，並對買方構成約束力；及
 - (iii) 署長就什麼構成一個住宅單位所作的決定將為最終決定，並對買方構成約束力。」
- (2) 公契及管理協議第 85 條規定：-
「管理人須在管理處備存一份由地政總署署長或任何其他不時替代其位的政府主管當局根據本公契附表三第 43 條所發出的同意的資料記錄，以供所有業主免費查閱及自費影印該資料記錄，並繳付合理費用。所有就此收取的費用一律撥入特別基金。」
- (3) 公契及管理協議附表三第 43 條規定：-
「43. 除非事先獲得地政總署署長或任何其他不時替代其位的政府主管當局的書面同意，否則任何業主不得進行或允許或容忍他人進行任何與住宅單位相關而可導致該住宅單位內部相連及通往任何毗連或毗鄰的住宅單位的工程，包括但不限於拆卸或更改任何分隔牆或任何樓板或天台樓板或任何間隔結構。而地政總署署長具有全權酌情給予同意或拒絕同意，倘若給予同意，業主須遵從地政總署署長按其全權酌情附加的任何條款及條件（包括支付費用）。」
- (4) 發展項目內所提供的住宅單位總數目為 590。
- (5) 平面圖所列的數字為以毫米標示之建築結構尺寸。
- (6) 因住宅物業的較高樓層的結構牆的厚度遞減，較高樓層的內部面積，一般比較低樓層的內部面積稍大。
- (7) 請參閱本售樓說明書第 20 頁為住宅物業樓面平面圖而設之備註及名詞及簡稱的圖例。

Notes:

- (1) Special Condition No. (8)(d) of the Land Grant stipulates that: -
“(d) the total number of residential units erected or to be erected on the lot shall not be less than 515, and for the purposes of this sub-clause (d):
 - (i) a detached, semi-detached or terraced house which is intended for use as a single family residence shall be regarded as a residential unit;
 - (ii) the decision of the Director as to whether a detached, semi-detached or terraced house constitutes or is intended for use as a single family residence shall be final and binding on the Purchaser; and
 - (iii) the decision of the Director as to what constitutes a residential unit shall be final and binding on the Purchaser.”
- (2) Clause 85 of the Deed of Mutual Covenant incorporating Management Agreement stipulates that: -
“85. The Manager shall deposit in the management office the record provided by the Director of Lands or any other Government authority in place of him from time to time of the information relating to the consent given under Clause 43 of the Third Schedule hereto for inspection by all Owners free of charge and taking copies at their own expense and on payment of a reasonable charge. All charges received shall be credited to the Special Fund.”
- (3) Clause 43 of the Third Schedule to the Deed of Mutual Covenant incorporating Management Agreement stipulates that: -
“43. No Owner shall carry out or permit or suffer to be carried out any works in connection with any Residential Unit, including but not limited to demolition or alteration of any partition wall or any floor or roof slab or any partition structure, which will result in such Residential Unit being internally linked to and accessible from any adjoining or adjacent Residential Unit, except with the prior written consent of the Director of Lands or any other Government authority in place of him from time to time, which consent may be given or withheld at his absolute discretion and if given, may be subject to such terms and conditions (including payment of fees) as may be imposed by him at his absolute discretion.”
- (4) The total number of residential units provided in the development is 590.
- (5) The dimensions in floor plans are all structural dimensions in millimeter.
- (6) The internal areas of the residential properties on the upper floors will generally be slightly larger than those on the lower floors because of the reducing thickness of the structural walls on the upper floors.
- (7) Please refer to page 20 of this sales brochure for the remarks and legends of the terms and abbreviations for the floor plans of residential properties.

第2座 28樓平面圖
Tower 2 28/F Floor Plan

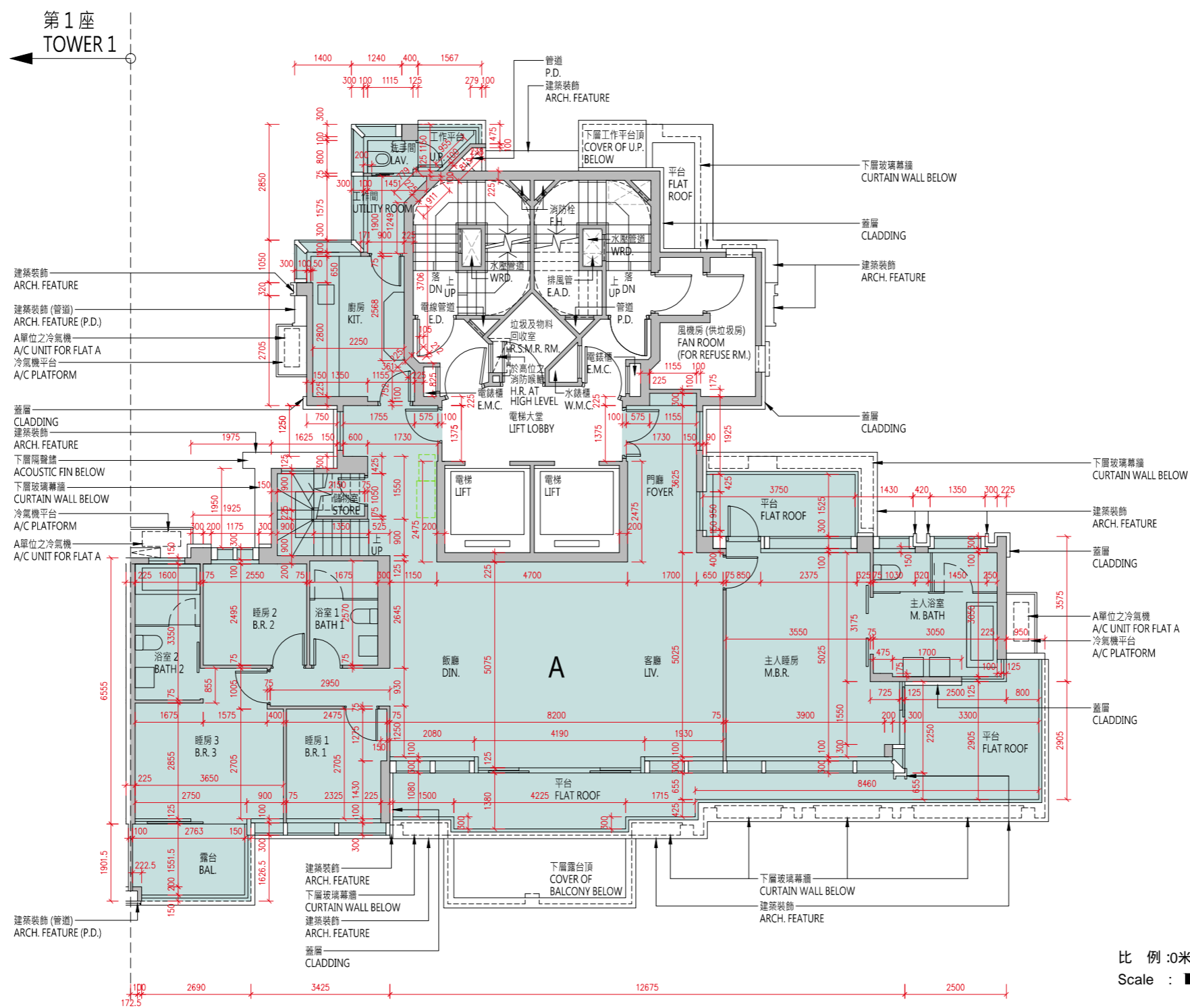

比例 : 0米/M 5米/M
Scale :

樓層 Floor	28樓 28 / F
層與層之間的高度 (毫米) Floor to Floor Height (mm)	3500
樓板 (不包括灰泥) 的厚度 (毫米) Thickness of Floor Slab (excluding plaster) (mm)	150, 200

10 發展項目的住宅物業的樓面平面圖

FLOOR PLANS OF RESIDENTIAL PROPERTIES IN THE DEVELOPMENT

備註：

- (1) 批地文件特別條件第 8(d) 條規定：-
「(d) 在該地段已建成或擬建的住宅單位數目須不少於 515，並就本 (d) 分條而言：
 - (i) 一座擬作為單一家庭住宅的獨立屋、半獨立屋或排屋均被視為一個住宅單位；
 - (ii) 署長就獨立屋、半獨立屋或排屋是否構成或擬作為單一家庭住宅所作的決定將為最終決定，並對買方構成約束力；及
 - (iii) 署長就什麼構成一個住宅單位所作的決定將為最終決定，並對買方構成約束力。」
- (2) 公契及管理協議第 85 條規定：-
「管理人須在管理處備存一份由地政總署署長或任何其他不時替代其位的政府主管當局根據本公契附表三第 43 條所發出的同意的資料記錄，以供所有業主免費查閱及自費影印該資料記錄，並繳付合理費用。所有就此收取的費用一律撥入特別基金。」
- (3) 公契及管理協議附表三第 43 條規定：-
「43. 除非事先獲得地政總署署長或任何其他不時替代其位的政府主管當局的書面同意，否則任何業主不得進行或允許或容忍他人進行任何與住宅單位相關而可導致該住宅單位內部相連及通往任何毗連或毗鄰的住宅單位的工程，包括但不限於拆卸或更改任何分隔牆或任何樓板或天台樓板或任何間隔結構。而地政總署署長具有全權酌情給予同意或拒絕同意，倘若給予同意，業主須遵從地政總署署長按其全權酌情附加的任何條款及條件（包括支付費用）。」
- (4) 發展項目內所提供的住宅單位總數目為 590。
- (5) 平面圖所列的數字為以毫米標示之建築結構尺寸。
- (6) 因住宅物業的較高樓層的結構牆的厚度遞減，較高樓層的內部面積，一般比較低樓層的內部面積稍大。
- (7) 請參閱本售樓說明書第 20 頁為住宅物業樓面平面圖而設之備註及名詞及簡稱的圖例。

Notes:

- (1) Special Condition No. (8)(d) of the Land Grant stipulates that: -
“(d) the total number of residential units erected or to be erected on the lot shall not be less than 515, and for the purposes of this sub-clause (d):
 - (i) a detached, semi-detached or terraced house which is intended for use as a single family residence shall be regarded as a residential unit;
 - (ii) the decision of the Director as to whether a detached, semi-detached or terraced house constitutes or is intended for use as a single family residence shall be final and binding on the Purchaser; and
 - (iii) the decision of the Director as to what constitutes a residential unit shall be final and binding on the Purchaser.”
- (2) Clause 85 of the Deed of Mutual Covenant incorporating Management Agreement stipulates that: -
“85. The Manager shall deposit in the management office the record provided by the Director of Lands or any other Government authority in place of him from time to time of the information relating to the consent given under Clause 43 of the Third Schedule hereto for inspection by all Owners free of charge and taking copies at their own expense and on payment of a reasonable charge. All charges received shall be credited to the Special Fund.”
- (3) Clause 43 of the Third Schedule to the Deed of Mutual Covenant incorporating Management Agreement stipulates that: -
“43. No Owner shall carry out or permit or suffer to be carried out any works in connection with any Residential Unit, including but not limited to demolition or alteration of any partition wall or any floor or roof slab or any partition structure, which will result in such Residential Unit being internally linked to and accessible from any adjoining or adjacent Residential Unit, except with the prior written consent of the Director of Lands or any other Government authority in place of him from time to time, which consent may be given or withheld at his absolute discretion and if given, may be subject to such terms and conditions (including payment of fees) as may be imposed by him at his absolute discretion.”
- (4) The total number of residential units provided in the development is 590.
- (5) The dimensions in floor plans are all structural dimensions in millimeter.
- (6) The internal areas of the residential properties on the upper floors will generally be slightly larger than those on the lower floors because of the reducing thickness of the structural walls on the upper floors.
- (7) Please refer to page 20 of this sales brochure for the remarks and legends of the terms and abbreviations for the floor plans of residential properties.

第2座 天台平面圖
Tower 2 Roof Floor Plan

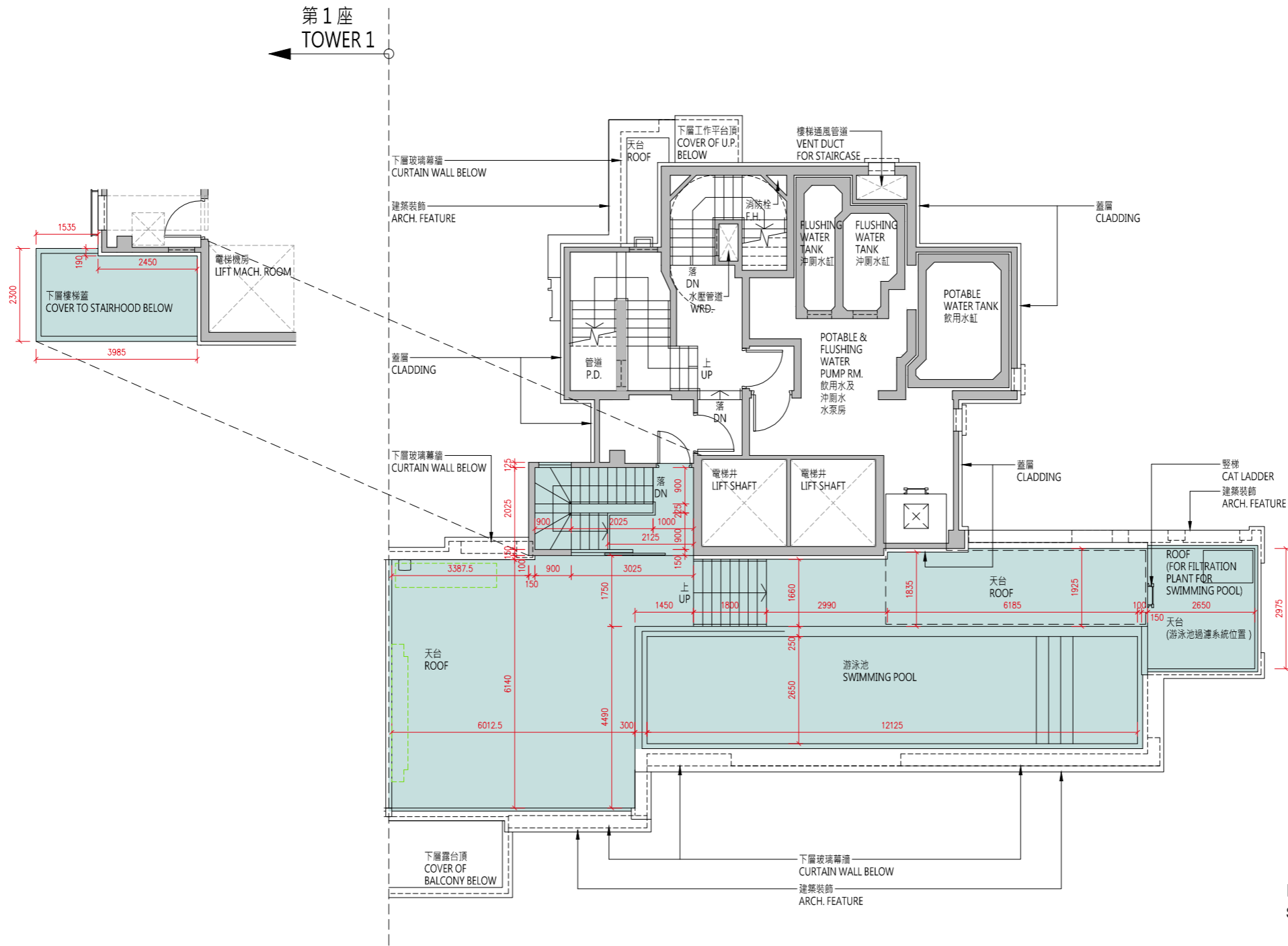

比例 : 0米/M 5米/M
Scale :

樓層 Floor	天台 Roof
層與層之間的高度 (毫米) Floor to Floor Height (mm)	N/A
樓板 (不包括灰泥) 的厚度 (毫米) Thickness of Floor Slab (excluding plaster) (mm)	N/A

10 發展項目的住宅物業的樓面平面圖

FLOOR PLANS OF RESIDENTIAL PROPERTIES IN THE DEVELOPMENT

備註：

- (1) 批地文件特別條件第 8(d) 條規定：-
「(d) 在該地段已建成或擬建的住宅單位數目須不少於 515，並就本 (d) 分條而言：
 - (i) 一座擬作為單一家庭住宅的獨立屋、半獨立屋或排屋均被視為一個住宅單位；
 - (ii) 署長就獨立屋、半獨立屋或排屋是否構成或擬作為單一家庭住宅所作的決定將為最終決定，並對買方構成約束力；及
 - (iii) 署長就什麼構成一個住宅單位所作的決定將為最終決定，並對買方構成約束力。」
- (2) 公契及管理協議第 85 條規定：-
「管理人須在管理處備存一份由地政總署署長或任何其他不時替代其位的政府主管當局根據本公契附表三第 43 條所發出的同意的資料記錄，以供所有業主免費查閱及自費影印該資料記錄，並繳付合理費用。所有就此收取的費用一律撥入特別基金。」
- (3) 公契及管理協議附表三第 43 條規定：-
「43. 除非事先獲得地政總署署長或任何其他不時替代其位的政府主管當局的書面同意，否則任何業主不得進行或允許或容忍他人進行任何與住宅單位相關而可導致該住宅單位內部相連及通往任何毗連或毗鄰的住宅單位的工程，包括但不限於拆卸或更改任何分隔牆或任何樓板或天台樓板或任何間隔結構。而地政總署署長具有全權酌情給予同意或拒絕同意，倘若給予同意，業主須遵從地政總署署長按其全權酌情附加的任何條款及條件（包括支付費用）。」
- (4) 發展項目內所提供的住宅單位總數目為 590。
- (5) 平面圖所列的數字為以毫米標示之建築結構尺寸。
- (6) 因住宅物業的較高樓層的結構牆的厚度遞減，較高樓層的內部面積，一般比較低樓層的內部面積稍大。
- (7) 請參閱本售樓說明書第 20 頁為住宅物業樓面平面圖而設之備註及名詞及簡稱的圖例。

Notes:

- (1) Special Condition No. (8)(d) of the Land Grant stipulates that: -
“(d) the total number of residential units erected or to be erected on the lot shall not be less than 515, and for the purposes of this sub-clause (d):
 - (i) a detached, semi-detached or terraced house which is intended for use as a single family residence shall be regarded as a residential unit;
 - (ii) the decision of the Director as to whether a detached, semi-detached or terraced house constitutes or is intended for use as a single family residence shall be final and binding on the Purchaser; and
 - (iii) the decision of the Director as to what constitutes a residential unit shall be final and binding on the Purchaser.”
- (2) Clause 85 of the Deed of Mutual Covenant incorporating Management Agreement stipulates that: -
“85. The Manager shall deposit in the management office the record provided by the Director of Lands or any other Government authority in place of him from time to time of the information relating to the consent given under Clause 43 of the Third Schedule hereto for inspection by all Owners free of charge and taking copies at their own expense and on payment of a reasonable charge. All charges received shall be credited to the Special Fund.”
- (3) Clause 43 of the Third Schedule to the Deed of Mutual Covenant incorporating Management Agreement stipulates that: -
“43. No Owner shall carry out or permit or suffer to be carried out any works in connection with any Residential Unit, including but not limited to demolition or alteration of any partition wall or any floor or roof slab or any partition structure, which will result in such Residential Unit being internally linked to and accessible from any adjoining or adjacent Residential Unit, except with the prior written consent of the Director of Lands or any other Government authority in place of him from time to time, which consent may be given or withheld at his absolute discretion and if given, may be subject to such terms and conditions (including payment of fees) as may be imposed by him at his absolute discretion.”
- (4) The total number of residential units provided in the development is 590.
- (5) The dimensions in floor plans are all structural dimensions in millimeter.
- (6) The internal areas of the residential properties on the upper floors will generally be slightly larger than those on the lower floors because of the reducing thickness of the structural walls on the upper floors.
- (7) Please refer to page 20 of this sales brochure for the remarks and legends of the terms and abbreviations for the floor plans of residential properties.

第3座 1樓平面圖
Tower 3 1/F Floor Plan

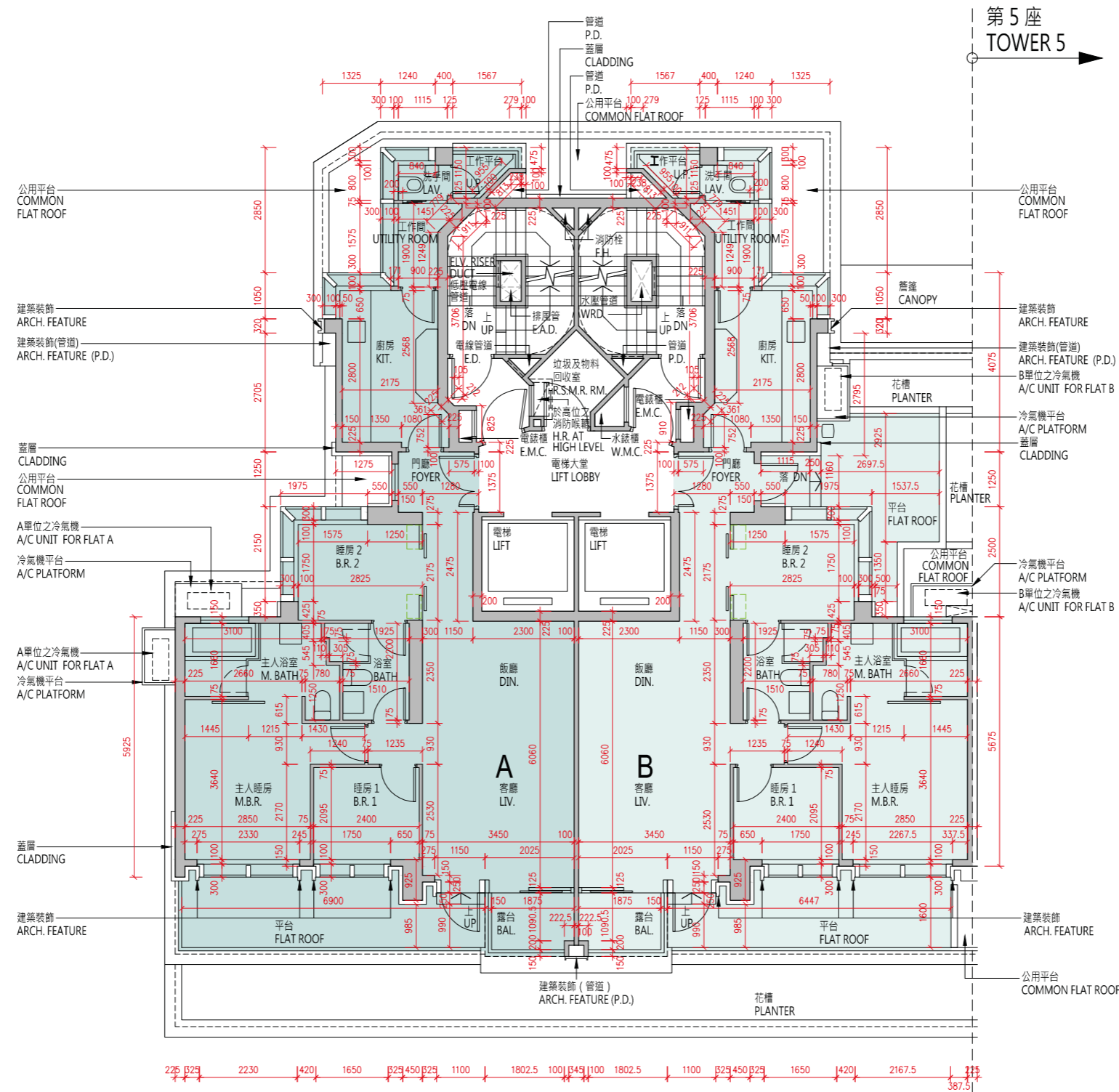

比例：0米/M 5米/M
Scale : 0m/M 5m/M

每個住宅物業 Each Residential Property	單位 Flat 樓層 Floor	A	B
層與層之間的高度 (毫米) Floor to Floor Height (mm)	1樓 1/F	3450	3450
樓板 (不包括灰泥) 的厚度 (毫米) Thickness of Floor Slab (excluding plaster) (mm)		150, 200	150, 200

10 發展項目的住宅物業的樓面平面圖

FLOOR PLANS OF RESIDENTIAL PROPERTIES IN THE DEVELOPMENT

備註：

- (1) 批地文件特別條件第 8(d) 條規定：-
「(d) 在該地段已建成或擬建的住宅單位數目須不少於 515，並就本 (d) 分條而言：
 - (i) 一座擬作為單一家庭住宅的獨立屋、半獨立屋或排屋均被視為一個住宅單位；
 - (ii) 署長就獨立屋、半獨立屋或排屋是否構成或擬作為單一家庭住宅所作的決定將為最終決定，並對買方構成約束力；及
 - (iii) 署長就什麼構成一個住宅單位所作的決定將為最終決定，並對買方構成約束力。」
- (2) 公契及管理協議第 85 條規定：-
「管理人須在管理處備存一份由地政總署署長或任何其他不時替代其位的政府主管當局根據本公契附表三第 43 條所發出的同意的資料記錄，以供所有業主免費查閱及自費影印該資料記錄，並繳付合理費用。所有就此收取的費用一律撥入特別基金。」
- (3) 公契及管理協議附表三第 43 條規定：-
「43. 除非事先獲得地政總署署長或任何其他不時替代其位的政府主管當局的書面同意，否則任何業主不得進行或允許或容忍他人進行任何與住宅單位相關而可導致該住宅單位內部相連及通往任何毗連或毗鄰的住宅單位的工程，包括但不限於拆卸或更改任何分隔牆或任何樓板或天台樓板或任何間隔結構。而地政總署署長具有全權酌情給予同意或拒絕同意，倘若給予同意，業主須遵從地政總署署長按其全權酌情附加的任何條款及條件（包括支付費用）。」
- (4) 發展項目內所提供的住宅單位總數目為 590。
- (5) 平面圖所列的數字為以毫米標示之建築結構尺寸。
- (6) 因住宅物業的較高樓層的結構牆的厚度遞減，較高樓層的內部面積，一般比較低樓層的內部面積稍大。
- (7) 請參閱本售樓說明書第 20 頁為住宅物業樓面平面圖而設之備註及名詞及簡稱的圖例。

Notes:

- (1) Special Condition No. (8)(d) of the Land Grant stipulates that: -
“(d) the total number of residential units erected or to be erected on the lot shall not be less than 515, and for the purposes of this sub-clause (d):
 - (i) a detached, semi-detached or terraced house which is intended for use as a single family residence shall be regarded as a residential unit;
 - (ii) the decision of the Director as to whether a detached, semi-detached or terraced house constitutes or is intended for use as a single family residence shall be final and binding on the Purchaser; and
 - (iii) the decision of the Director as to what constitutes a residential unit shall be final and binding on the Purchaser.”
- (2) Clause 85 of the Deed of Mutual Covenant incorporating Management Agreement stipulates that: -
“85. The Manager shall deposit in the management office the record provided by the Director of Lands or any other Government authority in place of him from time to time of the information relating to the consent given under Clause 43 of the Third Schedule hereto for inspection by all Owners free of charge and taking copies at their own expense and on payment of a reasonable charge. All charges received shall be credited to the Special Fund.”
- (3) Clause 43 of the Third Schedule to the Deed of Mutual Covenant incorporating Management Agreement stipulates that: -
“43. No Owner shall carry out or permit or suffer to be carried out any works in connection with any Residential Unit, including but not limited to demolition or alteration of any partition wall or any floor or roof slab or any partition structure, which will result in such Residential Unit being internally linked to and accessible from any adjoining or adjacent Residential Unit, except with the prior written consent of the Director of Lands or any other Government authority in place of him from time to time, which consent may be given or withheld at his absolute discretion and if given, may be subject to such terms and conditions (including payment of fees) as may be imposed by him at his absolute discretion.”
- (4) The total number of residential units provided in the development is 590.
- (5) The dimensions in floor plans are all structural dimensions in millimeter.
- (6) The internal areas of the residential properties on the upper floors will generally be slightly larger than those on the lower floors because of the reducing thickness of the structural walls on the upper floors.
- (7) Please refer to page 20 of this sales brochure for the remarks and legends of the terms and abbreviations for the floor plans of residential properties.

10 發展項目的住宅物業的樓面平面圖 FLOOR PLANS OF RESIDENTIAL PROPERTIES IN THE DEVELOPMENT

第3座 2樓至3樓、5樓至12樓、15樓至23樓、
25樓至27樓平面圖

Tower 3 2/F-3/F, 5/F-12/F, 15/F-23/F,
25/F-27/F Floor Plan

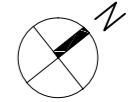
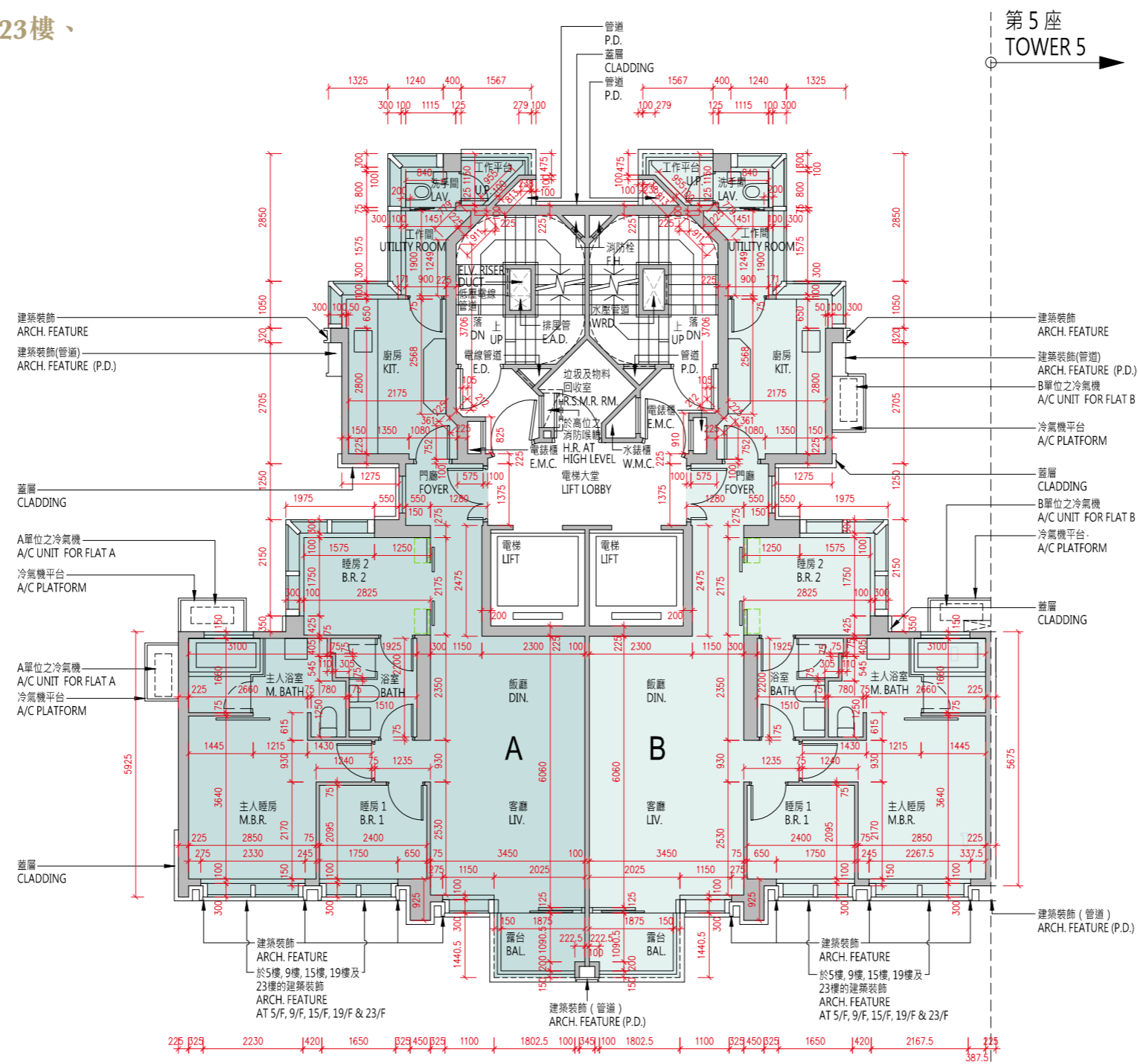

比例: 0米/M 5米/M
Scale: 0 5 10 15 20 25 30 35 40 45 50 55 60 65 70 75 80 85 90 95 100

每個住宅物業 Each Residential Property	單位 Flat	A	B
	樓層 Floor		
層與層之間的高度 (毫米) Floor to Floor Height (mm)	2樓至3樓、5樓至12樓、 15樓至23樓、25樓至26樓	3450	3450
樓板 (不包括灰泥) 的厚度 (毫米) Thickness of Floor Slab (excluding plaster) (mm)	2/F-3/F, 5/F-12/F, 15/F-23/F, 25/F-26/F	150, 200	150, 200

每個住宅物業 Each Residential Property	單位 Flat	A	B
	樓層 Floor		
層與層之間的高度 (毫米) Floor to Floor Height (mm)	27 樓	3150, 3180, 3400, 3470, 3500	3150, 3180, 3400, 3470, 3500
樓板 (不包括灰泥) 的厚度 (毫米) Thickness of Floor Slab (excluding plaster) (mm)	27/F	150, 200, 250	150, 250

10 發展項目的住宅物業的樓面平面圖

FLOOR PLANS OF RESIDENTIAL PROPERTIES IN THE DEVELOPMENT

備註：

- (1) 批地文件特別條件第 8(d) 條規定：-
「(d) 在該地段已建成或擬建的住宅單位數目須不少於 515，並就本 (d) 分條而言：
 - (i) 一座擬作為單一家庭住宅的獨立屋、半獨立屋或排屋均被視為一個住宅單位；
 - (ii) 署長就獨立屋、半獨立屋或排屋是否構成或擬作為單一家庭住宅所作的決定將為最終決定，並對買方構成約束力；及
 - (iii) 署長就什麼構成一個住宅單位所作的決定將為最終決定，並對買方構成約束力。」
- (2) 公契及管理協議第 85 條規定：-
「管理人須在管理處備存一份由地政總署署長或任何其他不時替代其位的政府主管當局根據本公契附表三第 43 條所發出的同意的資料記錄，以供所有業主免費查閱及自費影印該資料記錄，並繳付合理費用。所有就此收取的費用一律撥入特別基金。」
- (3) 公契及管理協議附表三第 43 條規定：-
「43. 除非事先獲得地政總署署長或任何其他不時替代其位的政府主管當局的書面同意，否則任何業主不得進行或允許或容忍他人進行任何與住宅單位相關而可導致該住宅單位內部相連及通往任何毗連或毗鄰的住宅單位的工程，包括但不限於拆卸或更改任何分隔牆或任何樓板或天台樓板或任何間隔結構。而地政總署署長具有全權酌情給予同意或拒絕同意，倘若給予同意，業主須遵從地政總署署長按其全權酌情附加的任何條款及條件 (包括支付費用)。」
- (4) 發展項目內所提供的住宅單位總數目為 590。
- (5) 平面圖所列的數字為以毫米標示之建築結構尺寸。
- (6) 因住宅物業的較高樓層的結構牆的厚度遞減，較高樓層的內部面積，一般比較低樓層的內部面積稍大。
- (7) 請參閱本售樓說明書第 20 頁為住宅物業樓面平面圖而設之備註及名詞及簡稱的圖例。

Notes:

- (1) Special Condition No. (8)(d) of the Land Grant stipulates that: -
“(d) the total number of residential units erected or to be erected on the lot shall not be less than 515, and for the purposes of this sub-clause (d):
 - (i) a detached, semi-detached or terraced house which is intended for use as a single family residence shall be regarded as a residential unit;
 - (ii) the decision of the Director as to whether a detached, semi-detached or terraced house constitutes or is intended for use as a single family residence shall be final and binding on the Purchaser; and
 - (iii) the decision of the Director as to what constitutes a residential unit shall be final and binding on the Purchaser.”
- (2) Clause 85 of the Deed of Mutual Covenant incorporating Management Agreement stipulates that: -
“85. The Manager shall deposit in the management office the record provided by the Director of Lands or any other Government authority in place of him from time to time of the information relating to the consent given under Clause 43 of the Third Schedule hereto for inspection by all Owners free of charge and taking copies at their own expense and on payment of a reasonable charge. All charges received shall be credited to the Special Fund.”
- (3) Clause 43 of the Third Schedule to the Deed of Mutual Covenant incorporating Management Agreement stipulates that: -
“43. No Owner shall carry out or permit or suffer to be carried out any works in connection with any Residential Unit, including but not limited to demolition or alteration of any partition wall or any floor or roof slab or any partition structure, which will result in such Residential Unit being internally linked to and accessible from any adjoining or adjacent Residential Unit, except with the prior written consent of the Director of Lands or any other Government authority in place of him from time to time, which consent may be given or withheld at his absolute discretion and if given, may be subject to such terms and conditions (including payment of fees) as may be imposed by him at his absolute discretion.”
- (4) The total number of residential units provided in the development is 590.
- (5) The dimensions in floor plans are all structural dimensions in millimeter.
- (6) The internal areas of the residential properties on the upper floors will generally be slightly larger than those on the lower floors because of the reducing thickness of the structural walls on the upper floors.
- (7) Please refer to page 20 of this sales brochure for the remarks and legends of the terms and abbreviations for the floor plans of residential properties.

第3座 28樓平面圖
Tower 3 28/F Floor Plan

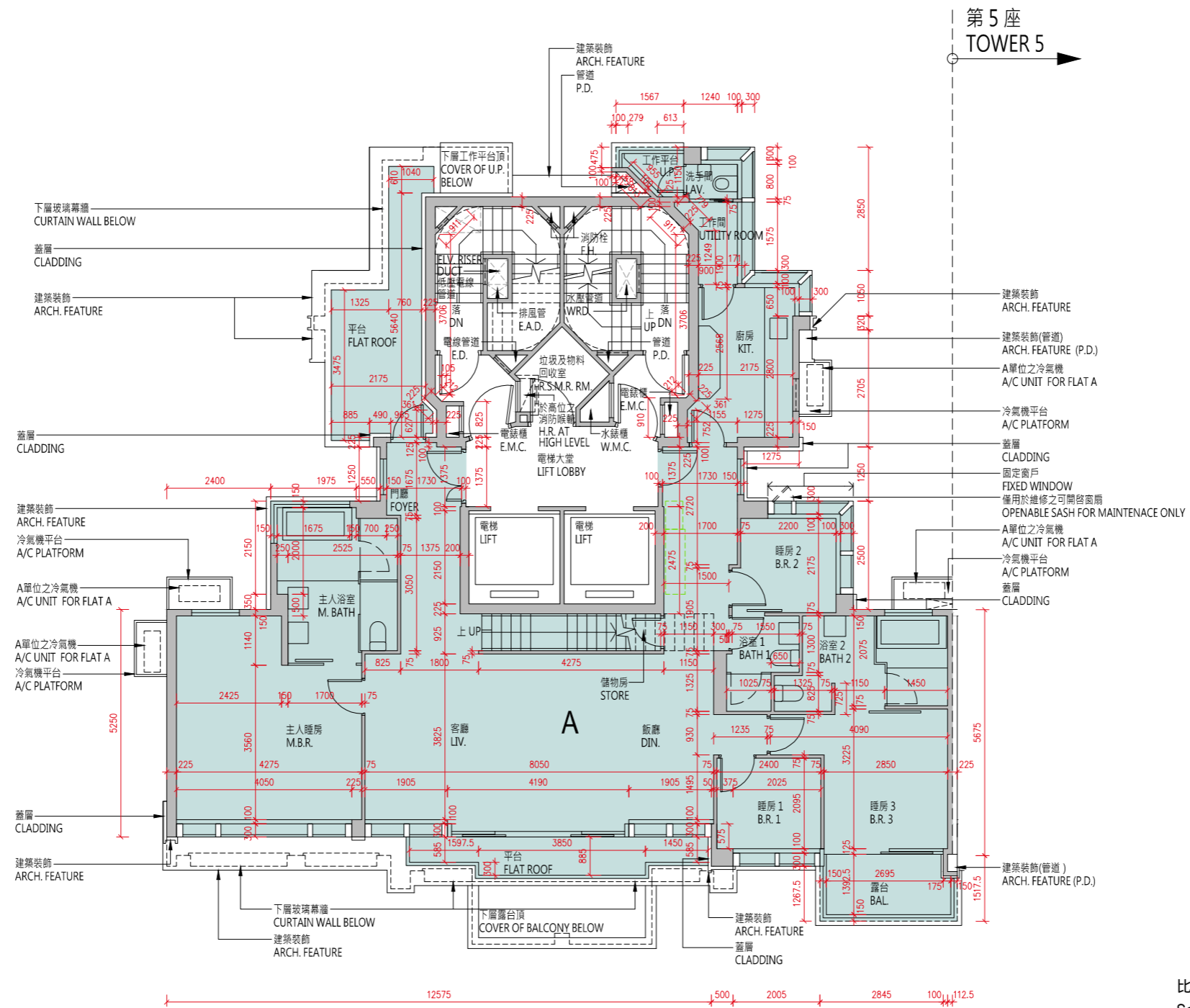
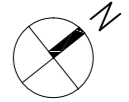

比例: 0米/M 5米/M
Scale:

樓層 Floor	28樓 28 / F
層與層之間的高度 (毫米) Floor to Floor Height (mm)	3500
樓板 (不包括灰泥) 的厚度 (毫米) Thickness of Floor Slab (excluding plaster) (mm)	150, 200

10 發展項目的住宅物業的樓面平面圖

FLOOR PLANS OF RESIDENTIAL PROPERTIES IN THE DEVELOPMENT

備註：

- (1) 批地文件特別條件第 8(d) 條規定：-
「(d) 在該地段已建成或擬建的住宅單位數目須不少於 515，並就本 (d) 分條而言：
 - (i) 一座擬作為單一家庭住宅的獨立屋、半獨立屋或排屋均被視為一個住宅單位；
 - (ii) 署長就獨立屋、半獨立屋或排屋是否構成或擬作為單一家庭住宅所作的決定將為最終決定，並對買方構成約束力；及
 - (iii) 署長就什麼構成一個住宅單位所作的決定將為最終決定，並對買方構成約束力。」
- (2) 公契及管理協議第 85 條規定：-
「管理人須在管理處備存一份由地政總署署長或任何其他不時替代其位的政府主管當局根據本公契附表三第 43 條所發出的同意的資料記錄，以供所有業主免費查閱及自費影印該資料記錄，並繳付合理費用。所有就此收取的費用一律撥入特別基金。」
- (3) 公契及管理協議附表三第 43 條規定：-
「43. 除非事先獲得地政總署署長或任何其他不時替代其位的政府主管當局的書面同意，否則任何業主不得進行或允許或容忍他人進行任何與住宅單位相關而可導致該住宅單位內部相連及通往任何毗連或毗鄰的住宅單位的工程，包括但不限於拆卸或更改任何分隔牆或任何樓板或天台樓板或任何間隔結構。而地政總署署長具有全權酌情給予同意或拒絕同意，倘若給予同意，業主須遵從地政總署署長按其全權酌情附加的任何條款及條件（包括支付費用）。」
- (4) 發展項目內所提供的住宅單位總數目為 590。
- (5) 平面圖所列的數字為以毫米標示之建築結構尺寸。
- (6) 因住宅物業的較高樓層的結構牆的厚度遞減，較高樓層的內部面積，一般比較低樓層的內部面積稍大。
- (7) 請參閱本售樓說明書第 20 頁為住宅物業樓面平面圖而設之備註及名詞及簡稱的圖例。

Notes:

- (1) Special Condition No. (8)(d) of the Land Grant stipulates that: -
“(d) the total number of residential units erected or to be erected on the lot shall not be less than 515, and for the purposes of this sub-clause (d):
 - (i) a detached, semi-detached or terraced house which is intended for use as a single family residence shall be regarded as a residential unit;
 - (ii) the decision of the Director as to whether a detached, semi-detached or terraced house constitutes or is intended for use as a single family residence shall be final and binding on the Purchaser; and
 - (iii) the decision of the Director as to what constitutes a residential unit shall be final and binding on the Purchaser.”
- (2) Clause 85 of the Deed of Mutual Covenant incorporating Management Agreement stipulates that: -
“85. The Manager shall deposit in the management office the record provided by the Director of Lands or any other Government authority in place of him from time to time of the information relating to the consent given under Clause 43 of the Third Schedule hereto for inspection by all Owners free of charge and taking copies at their own expense and on payment of a reasonable charge. All charges received shall be credited to the Special Fund.”
- (3) Clause 43 of the Third Schedule to the Deed of Mutual Covenant incorporating Management Agreement stipulates that: -
“43. No Owner shall carry out or permit or suffer to be carried out any works in connection with any Residential Unit, including but not limited to demolition or alteration of any partition wall or any floor or roof slab or any partition structure, which will result in such Residential Unit being internally linked to and accessible from any adjoining or adjacent Residential Unit, except with the prior written consent of the Director of Lands or any other Government authority in place of him from time to time, which consent may be given or withheld at his absolute discretion and if given, may be subject to such terms and conditions (including payment of fees) as may be imposed by him at his absolute discretion.”
- (4) The total number of residential units provided in the development is 590.
- (5) The dimensions in floor plans are all structural dimensions in millimeter.
- (6) The internal areas of the residential properties on the upper floors will generally be slightly larger than those on the lower floors because of the reducing thickness of the structural walls on the upper floors.
- (7) Please refer to page 20 of this sales brochure for the remarks and legends of the terms and abbreviations for the floor plans of residential properties.

第3座 天台平面圖
Tower 3 Roof Floor Plan

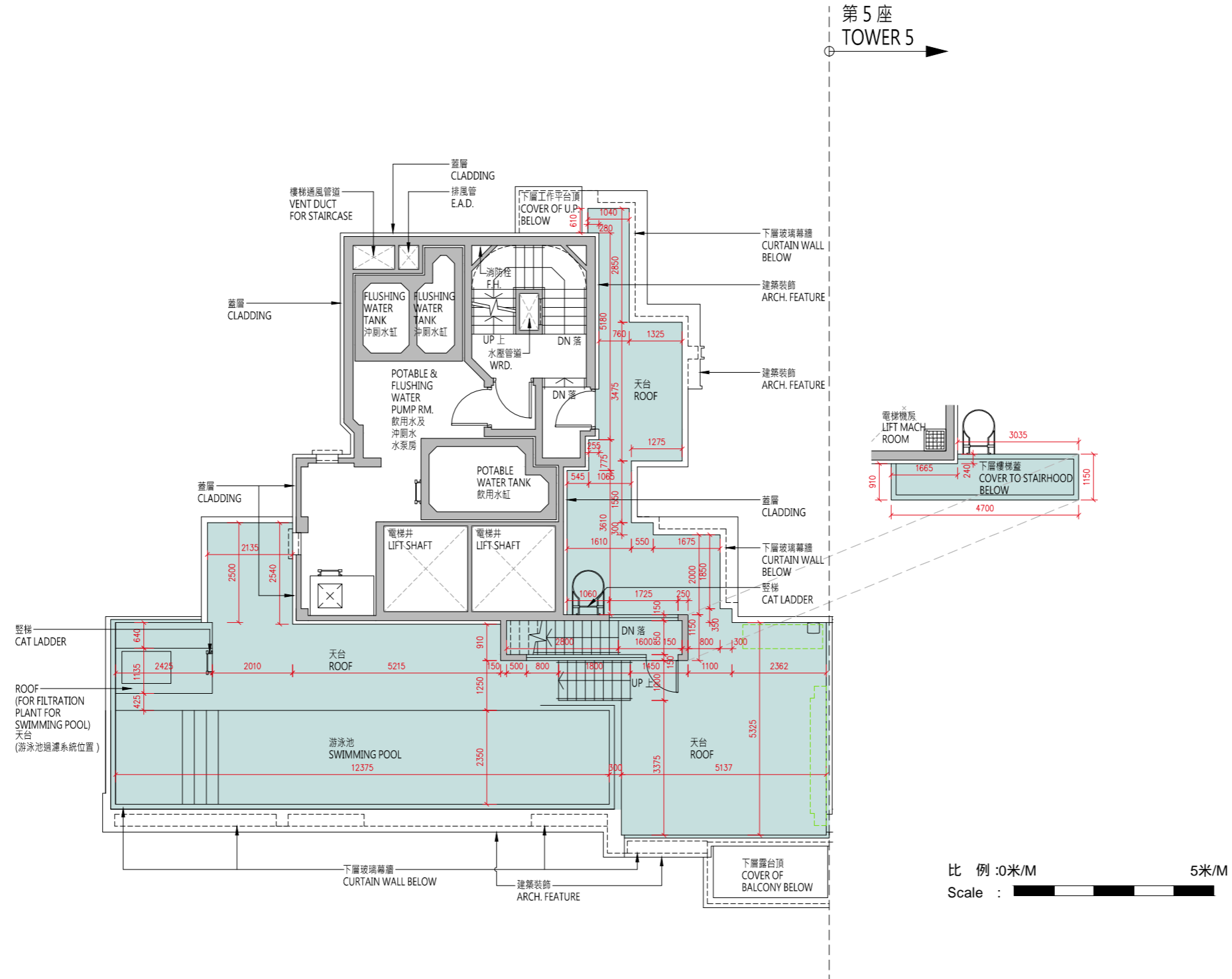
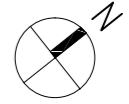

樓層 Floor	天台 Roof
層與層之間的高度 (毫米) Floor to Floor Height (mm)	N/A
樓板 (不包括灰泥) 的厚度 (毫米) Thickness of Floor Slab (excluding plaster) (mm)	N/A

10 發展項目的住宅物業的樓面平面圖

FLOOR PLANS OF RESIDENTIAL PROPERTIES IN THE DEVELOPMENT

備註：

- (1) 批地文件特別條件第 8(d) 條規定：-
「(d) 在該地段已建成或擬建的住宅單位數目須不少於 515，並就本 (d) 分條而言：
 - (i) 一座擬作為單一家庭住宅的獨立屋、半獨立屋或排屋均被視為一個住宅單位；
 - (ii) 署長就獨立屋、半獨立屋或排屋是否構成或擬作為單一家庭住宅所作的決定將為最終決定，並對買方構成約束力；及
 - (iii) 署長就什麼構成一個住宅單位所作的決定將為最終決定，並對買方構成約束力。」
- (2) 公契及管理協議第 85 條規定：-
「管理人須在管理處備存一份由地政總署署長或任何其他不時替代其位的政府主管當局根據本公契附表三第 43 條所發出的同意的資料記錄，以供所有業主免費查閱及自費影印該資料記錄，並繳付合理費用。所有就此收取的費用一律撥入特別基金。」
- (3) 公契及管理協議附表三第 43 條規定：-
「43. 除非事先獲得地政總署署長或任何其他不時替代其位的政府主管當局的書面同意，否則任何業主不得進行或允許或容忍他人進行任何與住宅單位相關而可導致該住宅單位內部相連及通往任何毗連或毗鄰的住宅單位的工程，包括但不限於拆卸或更改任何分隔牆或任何樓板或天台樓板或任何間隔結構。而地政總署署長具有全權酌情給予同意或拒絕同意，倘若給予同意，業主須遵從地政總署署長按其全權酌情附加的任何條款及條件（包括支付費用）。」
- (4) 發展項目內所提供的住宅單位總數目為 590。
- (5) 平面圖所列的數字為以毫米標示之建築結構尺寸。
- (6) 因住宅物業的較高樓層的結構牆的厚度遞減，較高樓層的內部面積，一般比較低樓層的內部面積稍大。
- (7) 請參閱本售樓說明書第 20 頁為住宅物業樓面平面圖而設之備註及名詞及簡稱的圖例。

Notes:

- (1) Special Condition No. (8)(d) of the Land Grant stipulates that: -
“(d) the total number of residential units erected or to be erected on the lot shall not be less than 515, and for the purposes of this sub-clause (d):
 - (i) a detached, semi-detached or terraced house which is intended for use as a single family residence shall be regarded as a residential unit;
 - (ii) the decision of the Director as to whether a detached, semi-detached or terraced house constitutes or is intended for use as a single family residence shall be final and binding on the Purchaser; and
 - (iii) the decision of the Director as to what constitutes a residential unit shall be final and binding on the Purchaser.”
- (2) Clause 85 of the Deed of Mutual Covenant incorporating Management Agreement stipulates that: -
“85. The Manager shall deposit in the management office the record provided by the Director of Lands or any other Government authority in place of him from time to time of the information relating to the consent given under Clause 43 of the Third Schedule hereto for inspection by all Owners free of charge and taking copies at their own expense and on payment of a reasonable charge. All charges received shall be credited to the Special Fund.”
- (3) Clause 43 of the Third Schedule to the Deed of Mutual Covenant incorporating Management Agreement stipulates that: -
“43. No Owner shall carry out or permit or suffer to be carried out any works in connection with any Residential Unit, including but not limited to demolition or alteration of any partition wall or any floor or roof slab or any partition structure, which will result in such Residential Unit being internally linked to and accessible from any adjoining or adjacent Residential Unit, except with the prior written consent of the Director of Lands or any other Government authority in place of him from time to time, which consent may be given or withheld at his absolute discretion and if given, may be subject to such terms and conditions (including payment of fees) as may be imposed by him at his absolute discretion.”
- (4) The total number of residential units provided in the development is 590.
- (5) The dimensions in floor plans are all structural dimensions in millimeter.
- (6) The internal areas of the residential properties on the upper floors will generally be slightly larger than those on the lower floors because of the reducing thickness of the structural walls on the upper floors.
- (7) Please refer to page 20 of this sales brochure for the remarks and legends of the terms and abbreviations for the floor plans of residential properties.

10 發展項目的住宅物業的樓面平面圖 FLOOR PLANS OF RESIDENTIAL PROPERTIES IN THE DEVELOPMENT

第5座1樓平面圖
Tower 5 1/F Floor Plan

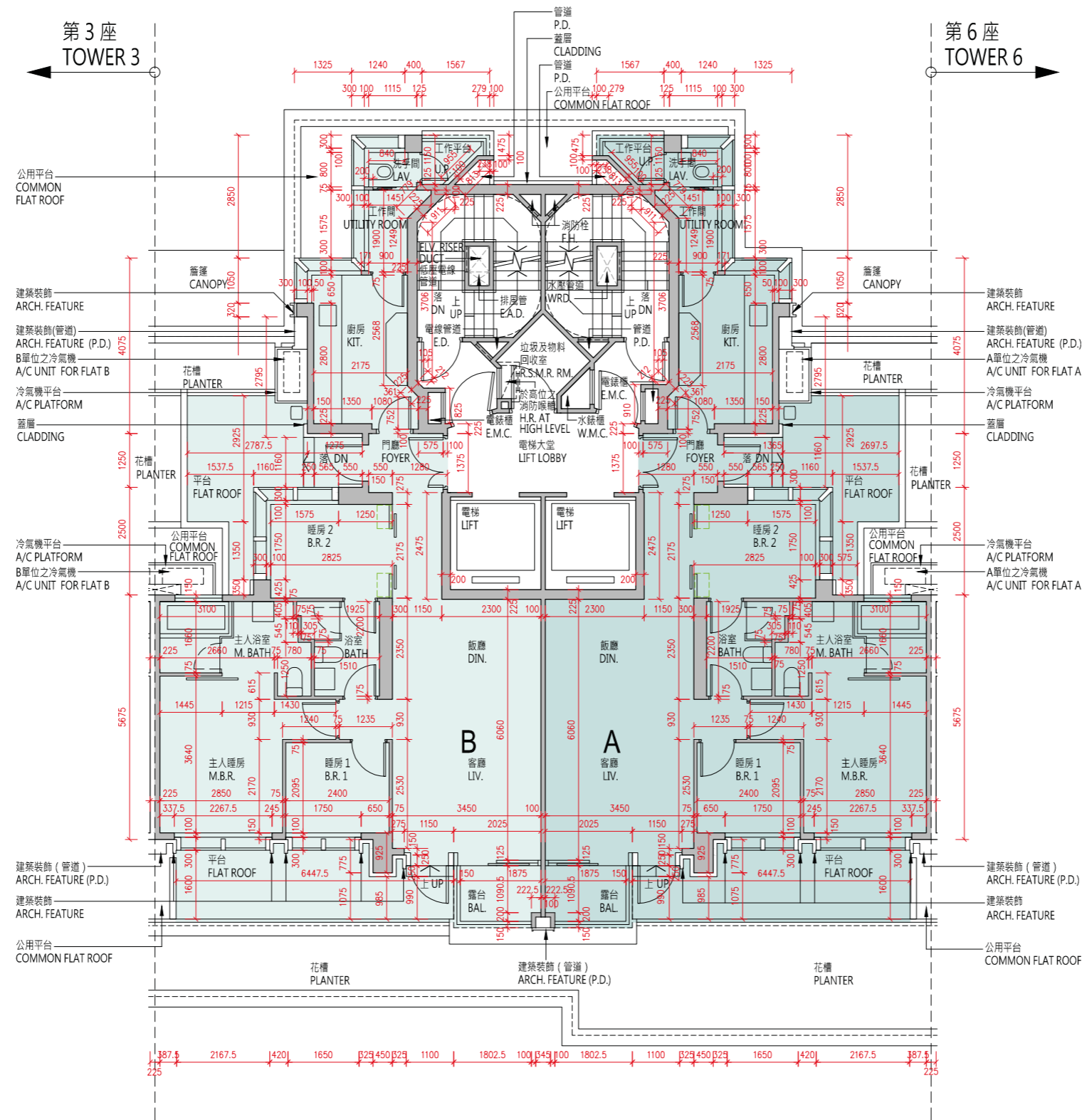

比例：0米/M
Scale : 0 5米/M

每個住宅物業 Each Residential Property	單位 Flat		
	樓層 Floor	A	B
層與層之間的高度 (毫米) Floor to Floor Height (mm)	1 樓	3450	3450
樓板 (不包括灰泥) 的厚度 (毫米) Thickness of Floor Slab (excluding plaster) (mm)	1/F	150, 200	150, 200

10 發展項目的住宅物業的樓面平面圖

FLOOR PLANS OF RESIDENTIAL PROPERTIES IN THE DEVELOPMENT

備註：

- (1) 批地文件特別條件第 8(d) 條規定：-
「(d) 在該地段已建成或擬建的住宅單位數目須不少於 515，並就本 (d) 分條而言：
 - (i) 一座擬作為單一家庭住宅的獨立屋、半獨立屋或排屋均被視為一個住宅單位；
 - (ii) 署長就獨立屋、半獨立屋或排屋是否構成或擬作為單一家庭住宅所作的決定將為最終決定，並對買方構成約束力；及
 - (iii) 署長就什麼構成一個住宅單位所作的決定將為最終決定，並對買方構成約束力。」
- (2) 公契及管理協議第 85 條規定：-
「管理人須在管理處備存一份由地政總署署長或任何其他不時替代其位的政府主管當局根據本公契附表三第 43 條所發出的同意的資料記錄，以供所有業主免費查閱及自費影印該資料記錄，並繳付合理費用。所有就此收取的費用一律撥入特別基金。」
- (3) 公契及管理協議附表三第 43 條規定：-
「43. 除非事先獲得地政總署署長或任何其他不時替代其位的政府主管當局的書面同意，否則任何業主不得進行或允許或容忍他人進行任何與住宅單位相關而可導致該住宅單位內部相連及通往任何毗連或毗鄰的住宅單位的工程，包括但不限於拆卸或更改任何分隔牆或任何樓板或天台樓板或任何間隔結構。而地政總署署長具有全權酌情給予同意或拒絕同意，倘若給予同意，業主須遵從地政總署署長按其全權酌情附加的任何條款及條件（包括支付費用）。」
- (4) 發展項目內所提供的住宅單位總數目為 590。
- (5) 平面圖所列的數字為以毫米標示之建築結構尺寸。
- (6) 因住宅物業的較高樓層的結構牆的厚度遞減，較高樓層的內部面積，一般比較低樓層的內部面積稍大。
- (7) 請參閱本售樓說明書第 20 頁為住宅物業樓面平面圖而設之備註及名詞及簡稱的圖例。

Notes:

- (1) Special Condition No. (8)(d) of the Land Grant stipulates that: -
“(d) the total number of residential units erected or to be erected on the lot shall not be less than 515, and for the purposes of this sub-clause (d):
 - (i) a detached, semi-detached or terraced house which is intended for use as a single family residence shall be regarded as a residential unit;
 - (ii) the decision of the Director as to whether a detached, semi-detached or terraced house constitutes or is intended for use as a single family residence shall be final and binding on the Purchaser; and
 - (iii) the decision of the Director as to what constitutes a residential unit shall be final and binding on the Purchaser.”
- (2) Clause 85 of the Deed of Mutual Covenant incorporating Management Agreement stipulates that: -
“85. The Manager shall deposit in the management office the record provided by the Director of Lands or any other Government authority in place of him from time to time of the information relating to the consent given under Clause 43 of the Third Schedule hereto for inspection by all Owners free of charge and taking copies at their own expense and on payment of a reasonable charge. All charges received shall be credited to the Special Fund.”
- (3) Clause 43 of the Third Schedule to the Deed of Mutual Covenant incorporating Management Agreement stipulates that: -
“43. No Owner shall carry out or permit or suffer to be carried out any works in connection with any Residential Unit, including but not limited to demolition or alteration of any partition wall or any floor or roof slab or any partition structure, which will result in such Residential Unit being internally linked to and accessible from any adjoining or adjacent Residential Unit, except with the prior written consent of the Director of Lands or any other Government authority in place of him from time to time, which consent may be given or withheld at his absolute discretion and if given, may be subject to such terms and conditions (including payment of fees) as may be imposed by him at his absolute discretion.”
- (4) The total number of residential units provided in the development is 590.
- (5) The dimensions in floor plans are all structural dimensions in millimeter.
- (6) The internal areas of the residential properties on the upper floors will generally be slightly larger than those on the lower floors because of the reducing thickness of the structural walls on the upper floors.
- (7) Please refer to page 20 of this sales brochure for the remarks and legends of the terms and abbreviations for the floor plans of residential properties.

10 發展項目的住宅物業的樓面平面圖 FLOOR PLANS OF RESIDENTIAL PROPERTIES IN THE DEVELOPMENT

第5座 2樓至3樓、5樓至12樓、15樓至23樓、
25樓至27樓平面圖

Tower 5 2/F-3/F, 5/F-12/F, 15/F-23/F,
25/F-27/F Floor Plan

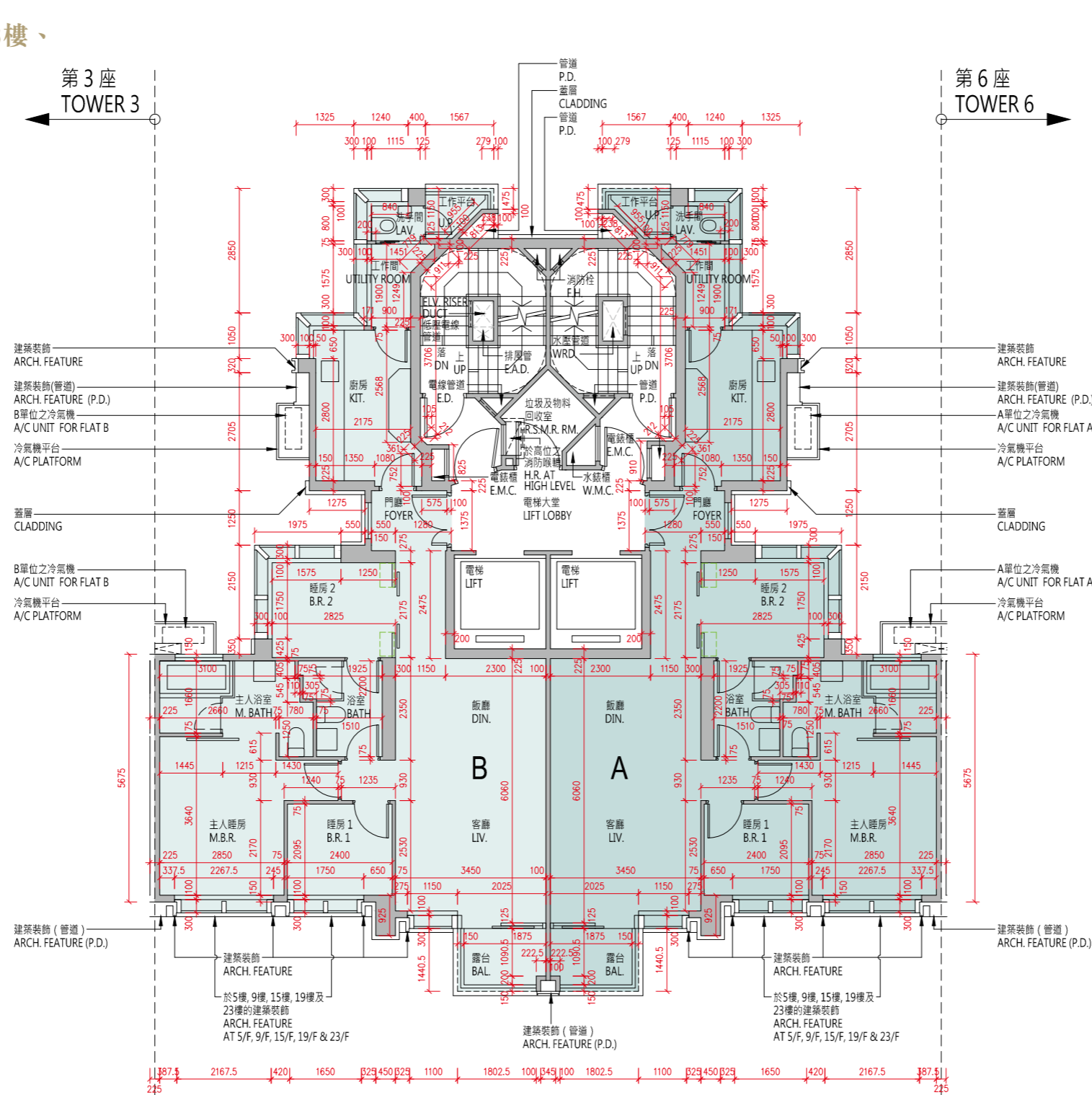

每個住宅物業 Each Residential Property	單位 Flat 樓層 Floor	單位 Flat	
		A	B
層與層之間的高度 (毫米) Floor to Floor Height (mm)	2樓至3樓、5樓至12樓、 15樓至23樓、25樓至26樓	3450	3450
樓板 (不包括灰泥) 的厚度 (毫米) Thickness of Floor Slab (excluding plaster) (mm)	2/F-3/F, 5/F-12/F, 15/F-23/F, 25/F-26/F	150, 200	150, 200

每個住宅物業 Each Residential Property	單位 Flat 樓層 Floor	單位 Flat	
		A	B
層與層之間的高度 (毫米) Floor to Floor Height (mm)	27樓	3150, 3180, 3400, 3470, 3500	3150, 3180, 3400, 3470, 3500
樓板 (不包括灰泥) 的厚度 (毫米) Thickness of Floor Slab (excluding plaster) (mm)	27/F	150, 250	150, 200, 250

10 發展項目的住宅物業的樓面平面圖

FLOOR PLANS OF RESIDENTIAL PROPERTIES IN THE DEVELOPMENT

備註：

- (1) 批地文件特別條件第 8(d) 條規定：-
「(d) 在該地段已建成或擬建的住宅單位數目須不少於 515，並就本 (d) 分條而言：
 - (i) 一座擬作為單一家庭住宅的獨立屋、半獨立屋或排屋均被視為一個住宅單位；
 - (ii) 署長就獨立屋、半獨立屋或排屋是否構成或擬作為單一家庭住宅所作的決定將為最終決定，並對買方構成約束力；及
 - (iii) 署長就什麼構成一個住宅單位所作的決定將為最終決定，並對買方構成約束力。」
- (2) 公契及管理協議第 85 條規定：-
「管理人須在管理處備存一份由地政總署署長或任何其他不時替代其位的政府主管當局根據本公契附表三第 43 條所發出的同意的資料記錄，以供所有業主免費查閱及自費影印該資料記錄，並繳付合理費用。所有就此收取的費用一律撥入特別基金。」
- (3) 公契及管理協議附表三第 43 條規定：-
「43. 除非事先獲得地政總署署長或任何其他不時替代其位的政府主管當局的書面同意，否則任何業主不得進行或允許或容忍他人進行任何與住宅單位相關而可導致該住宅單位內部相連及通往任何毗連或毗鄰的住宅單位的工程，包括但不限於拆卸或更改任何分隔牆或任何樓板或天台樓板或任何間隔結構。而地政總署署長具有全權酌情給予同意或拒絕同意，倘若給予同意，業主須遵從地政總署署長按其全權酌情附加的任何條款及條件（包括支付費用）。」
- (4) 發展項目內所提供的住宅單位總數目為 590。
- (5) 平面圖所列的數字為以毫米標示之建築結構尺寸。
- (6) 因住宅物業的較高樓層的結構牆的厚度遞減，較高樓層的內部面積，一般比較低樓層的內部面積稍大。
- (7) 請參閱本售樓說明書第 20 頁為住宅物業樓面平面圖而設之備註及名詞及簡稱的圖例。

Notes:

- (1) Special Condition No. (8)(d) of the Land Grant stipulates that: -
“(d) the total number of residential units erected or to be erected on the lot shall not be less than 515, and for the purposes of this sub-clause (d):
 - (i) a detached, semi-detached or terraced house which is intended for use as a single family residence shall be regarded as a residential unit;
 - (ii) the decision of the Director as to whether a detached, semi-detached or terraced house constitutes or is intended for use as a single family residence shall be final and binding on the Purchaser; and
 - (iii) the decision of the Director as to what constitutes a residential unit shall be final and binding on the Purchaser.”
- (2) Clause 85 of the Deed of Mutual Covenant incorporating Management Agreement stipulates that: -
“85. The Manager shall deposit in the management office the record provided by the Director of Lands or any other Government authority in place of him from time to time of the information relating to the consent given under Clause 43 of the Third Schedule hereto for inspection by all Owners free of charge and taking copies at their own expense and on payment of a reasonable charge. All charges received shall be credited to the Special Fund.”
- (3) Clause 43 of the Third Schedule to the Deed of Mutual Covenant incorporating Management Agreement stipulates that: -
“43. No Owner shall carry out or permit or suffer to be carried out any works in connection with any Residential Unit, including but not limited to demolition or alteration of any partition wall or any floor or roof slab or any partition structure, which will result in such Residential Unit being internally linked to and accessible from any adjoining or adjacent Residential Unit, except with the prior written consent of the Director of Lands or any other Government authority in place of him from time to time, which consent may be given or withheld at his absolute discretion and if given, may be subject to such terms and conditions (including payment of fees) as may be imposed by him at his absolute discretion.”
- (4) The total number of residential units provided in the development is 590.
- (5) The dimensions in floor plans are all structural dimensions in millimeter.
- (6) The internal areas of the residential properties on the upper floors will generally be slightly larger than those on the lower floors because of the reducing thickness of the structural walls on the upper floors.
- (7) Please refer to page 20 of this sales brochure for the remarks and legends of the terms and abbreviations for the floor plans of residential properties.

第5座 28樓平面圖
Tower 5 28/F Floor Plan

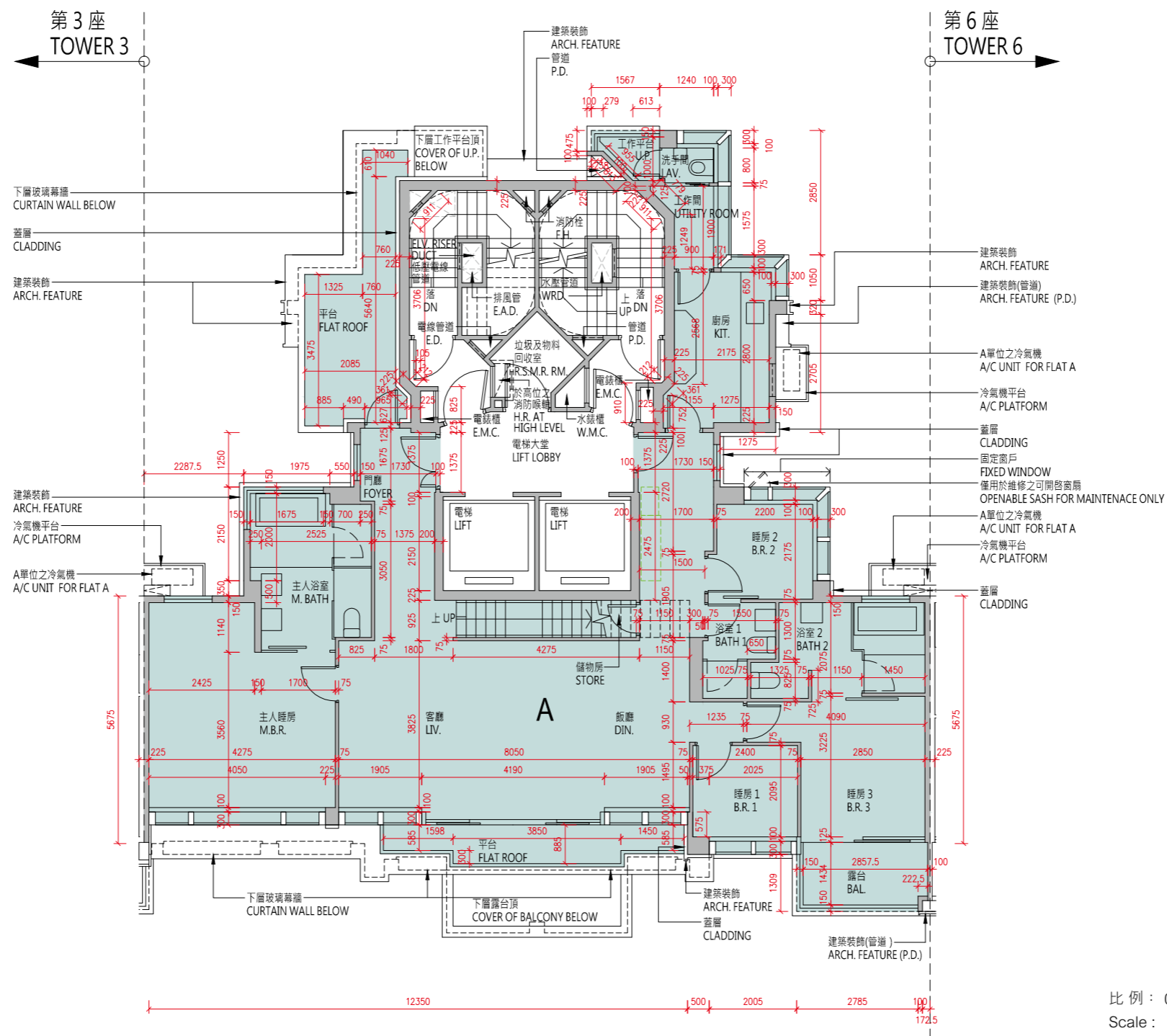

樓層 Floor	28樓 28 / F
層與層之間的高度 (毫米) Floor to Floor Height (mm)	3500
樓板 (不包括灰泥) 的厚度 (毫米) Thickness of Floor Slab (excluding plaster) (mm)	150, 200

10 發展項目的住宅物業的樓面平面圖

FLOOR PLANS OF RESIDENTIAL PROPERTIES IN THE DEVELOPMENT

備註：

- (1) 批地文件特別條件第 8(d) 條規定：-
「(d) 在該地段已建成或擬建的住宅單位數目須不少於 515，並就本 (d) 分條而言：
 - (i) 一座擬作為單一家庭住宅的獨立屋、半獨立屋或排屋均被視為一個住宅單位；
 - (ii) 署長就獨立屋、半獨立屋或排屋是否構成或擬作為單一家庭住宅所作的決定將為最終決定，並對買方構成約束力；及
 - (iii) 署長就什麼構成一個住宅單位所作的決定將為最終決定，並對買方構成約束力。」
- (2) 公契及管理協議第 85 條規定：-
「管理人須在管理處備存一份由地政總署署長或任何其他不時替代其位的政府主管當局根據本公契附表三第 43 條所發出的同意的資料記錄，以供所有業主免費查閱及自費影印該資料記錄，並繳付合理費用。所有就此收取的費用一律撥入特別基金。」
- (3) 公契及管理協議附表三第 43 條規定：-
「43. 除非事先獲得地政總署署長或任何其他不時替代其位的政府主管當局的書面同意，否則任何業主不得進行或允許或容忍他人進行任何與住宅單位相關而可導致該住宅單位內部相連及通往任何毗連或毗鄰的住宅單位的工程，包括但不限於拆卸或更改任何分隔牆或任何樓板或天台樓板或任何間隔結構。而地政總署署長具有全權酌情給予同意或拒絕同意，倘若給予同意，業主須遵從地政總署署長按其全權酌情附加的任何條款及條件（包括支付費用）。」
- (4) 發展項目內所提供的住宅單位總數目為 590。
- (5) 平面圖所列的數字為以毫米標示之建築結構尺寸。
- (6) 因住宅物業的較高樓層的結構牆的厚度遞減，較高樓層的內部面積，一般比較低樓層的內部面積稍大。
- (7) 請參閱本售樓說明書第 20 頁為住宅物業樓面平面圖而設之備註及名詞及簡稱的圖例。

Notes:

- (1) Special Condition No. (8)(d) of the Land Grant stipulates that: -
“(d) the total number of residential units erected or to be erected on the lot shall not be less than 515, and for the purposes of this sub-clause (d):
 - (i) a detached, semi-detached or terraced house which is intended for use as a single family residence shall be regarded as a residential unit;
 - (ii) the decision of the Director as to whether a detached, semi-detached or terraced house constitutes or is intended for use as a single family residence shall be final and binding on the Purchaser; and
 - (iii) the decision of the Director as to what constitutes a residential unit shall be final and binding on the Purchaser.”
- (2) Clause 85 of the Deed of Mutual Covenant incorporating Management Agreement stipulates that: -
“85. The Manager shall deposit in the management office the record provided by the Director of Lands or any other Government authority in place of him from time to time of the information relating to the consent given under Clause 43 of the Third Schedule hereto for inspection by all Owners free of charge and taking copies at their own expense and on payment of a reasonable charge. All charges received shall be credited to the Special Fund.”
- (3) Clause 43 of the Third Schedule to the Deed of Mutual Covenant incorporating Management Agreement stipulates that: -
“43. No Owner shall carry out or permit or suffer to be carried out any works in connection with any Residential Unit, including but not limited to demolition or alteration of any partition wall or any floor or roof slab or any partition structure, which will result in such Residential Unit being internally linked to and accessible from any adjoining or adjacent Residential Unit, except with the prior written consent of the Director of Lands or any other Government authority in place of him from time to time, which consent may be given or withheld at his absolute discretion and if given, may be subject to such terms and conditions (including payment of fees) as may be imposed by him at his absolute discretion.”
- (4) The total number of residential units provided in the development is 590.
- (5) The dimensions in floor plans are all structural dimensions in millimeter.
- (6) The internal areas of the residential properties on the upper floors will generally be slightly larger than those on the lower floors because of the reducing thickness of the structural walls on the upper floors.
- (7) Please refer to page 20 of this sales brochure for the remarks and legends of the terms and abbreviations for the floor plans of residential properties.

第5座 天台平面圖
Tower 5 Roof Floor Plan

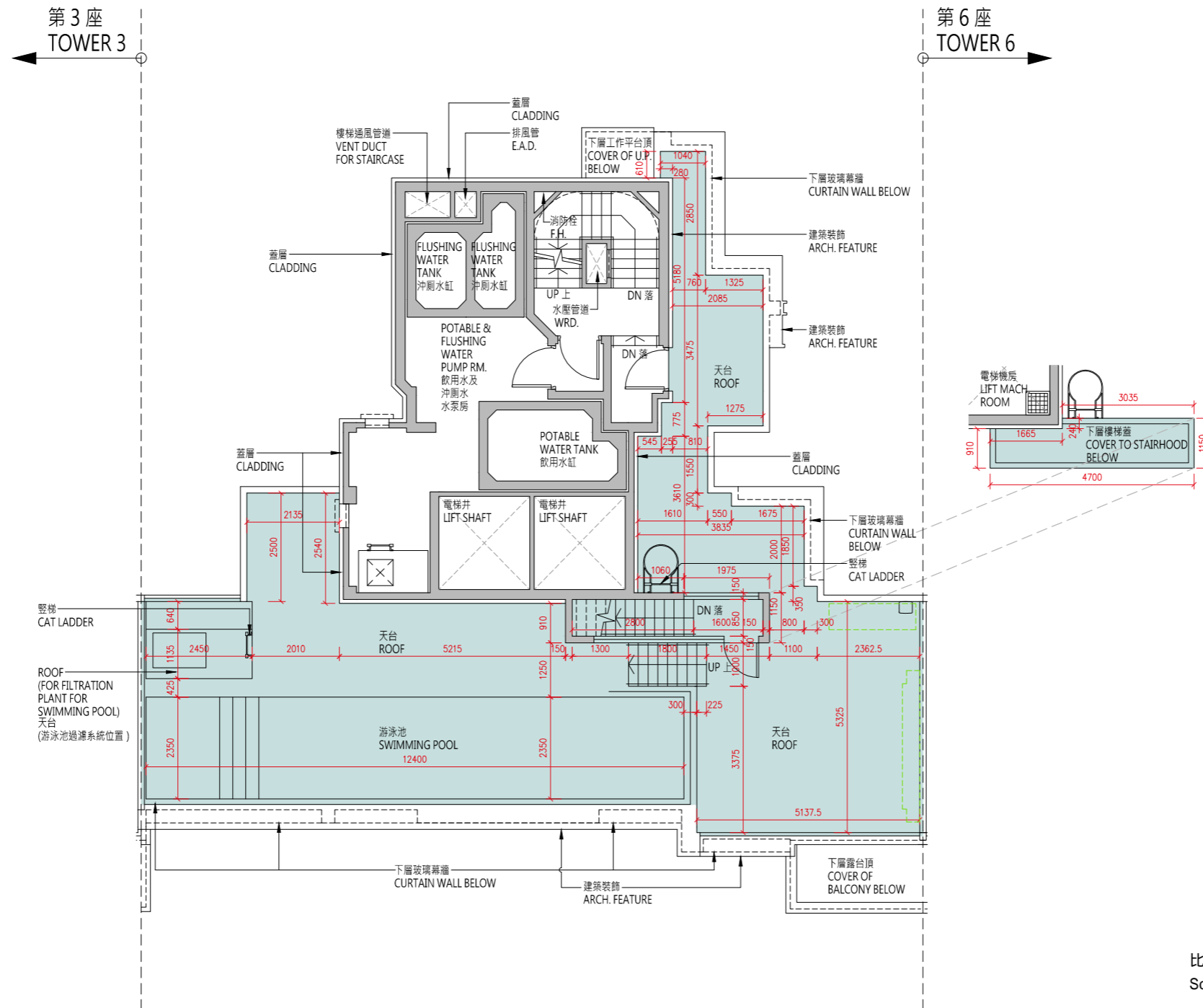
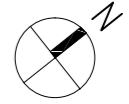

比例 : 0米/M 5米/M
Scale :

樓層 Floor	天台 Roof
層與層之間的高度 (毫米) Floor to Floor Height (mm)	N/A
樓板 (不包括灰泥) 的厚度 (毫米) Thickness of Floor Slab (excluding plaster) (mm)	N/A

10 發展項目的住宅物業的樓面平面圖

FLOOR PLANS OF RESIDENTIAL PROPERTIES IN THE DEVELOPMENT

備註：

- (1) 批地文件特別條件第 8(d) 條規定：-
「(d) 在該地段已建成或擬建的住宅單位數目須不少於 515，並就本 (d) 分條而言：
 - (i) 一座擬作為單一家庭住宅的獨立屋、半獨立屋或排屋均被視為一個住宅單位；
 - (ii) 署長就獨立屋、半獨立屋或排屋是否構成或擬作為單一家庭住宅所作的決定將為最終決定，並對買方構成約束力；及
 - (iii) 署長就什麼構成一個住宅單位所作的決定將為最終決定，並對買方構成約束力。」
- (2) 公契及管理協議第 85 條規定：-
「管理人須在管理處備存一份由地政總署署長或任何其他不時替代其位的政府主管當局根據本公契附表三第 43 條所發出的同意的資料記錄，以供所有業主免費查閱及自費影印該資料記錄，並繳付合理費用。所有就此收取的費用一律撥入特別基金。」
- (3) 公契及管理協議附表三第 43 條規定：-
「43. 除非事先獲得地政總署署長或任何其他不時替代其位的政府主管當局的書面同意，否則任何業主不得進行或允許或容忍他人進行任何與住宅單位相關而可導致該住宅單位內部相連及通往任何毗連或毗鄰的住宅單位的工程，包括但不限於拆卸或更改任何分隔牆或任何樓板或天台樓板或任何間隔結構。而地政總署署長具有全權酌情給予同意或拒絕同意，倘若給予同意，業主須遵從地政總署署長按其全權酌情附加的任何條款及條件（包括支付費用）。」
- (4) 發展項目內所提供的住宅單位總數目為 590。
- (5) 平面圖所列的數字為以毫米標示之建築結構尺寸。
- (6) 因住宅物業的較高樓層的結構牆的厚度遞減，較高樓層的內部面積，一般比較低樓層的內部面積稍大。
- (7) 請參閱本售樓說明書第 20 頁為住宅物業樓面平面圖而設之備註及名詞及簡稱的圖例。

Notes:

- (1) Special Condition No. (8)(d) of the Land Grant stipulates that: -
“(d) the total number of residential units erected or to be erected on the lot shall not be less than 515, and for the purposes of this sub-clause (d):
 - (i) a detached, semi-detached or terraced house which is intended for use as a single family residence shall be regarded as a residential unit;
 - (ii) the decision of the Director as to whether a detached, semi-detached or terraced house constitutes or is intended for use as a single family residence shall be final and binding on the Purchaser; and
 - (iii) the decision of the Director as to what constitutes a residential unit shall be final and binding on the Purchaser.”
- (2) Clause 85 of the Deed of Mutual Covenant incorporating Management Agreement stipulates that: -
“85. The Manager shall deposit in the management office the record provided by the Director of Lands or any other Government authority in place of him from time to time of the information relating to the consent given under Clause 43 of the Third Schedule hereto for inspection by all Owners free of charge and taking copies at their own expense and on payment of a reasonable charge. All charges received shall be credited to the Special Fund.”
- (3) Clause 43 of the Third Schedule to the Deed of Mutual Covenant incorporating Management Agreement stipulates that: -
“43. No Owner shall carry out or permit or suffer to be carried out any works in connection with any Residential Unit, including but not limited to demolition or alteration of any partition wall or any floor or roof slab or any partition structure, which will result in such Residential Unit being internally linked to and accessible from any adjoining or adjacent Residential Unit, except with the prior written consent of the Director of Lands or any other Government authority in place of him from time to time, which consent may be given or withheld at his absolute discretion and if given, may be subject to such terms and conditions (including payment of fees) as may be imposed by him at his absolute discretion.”
- (4) The total number of residential units provided in the development is 590.
- (5) The dimensions in floor plans are all structural dimensions in millimeter.
- (6) The internal areas of the residential properties on the upper floors will generally be slightly larger than those on the lower floors because of the reducing thickness of the structural walls on the upper floors.
- (7) Please refer to page 20 of this sales brochure for the remarks and legends of the terms and abbreviations for the floor plans of residential properties.

第6座1樓平面圖
Tower 6 1/F Floor Plan

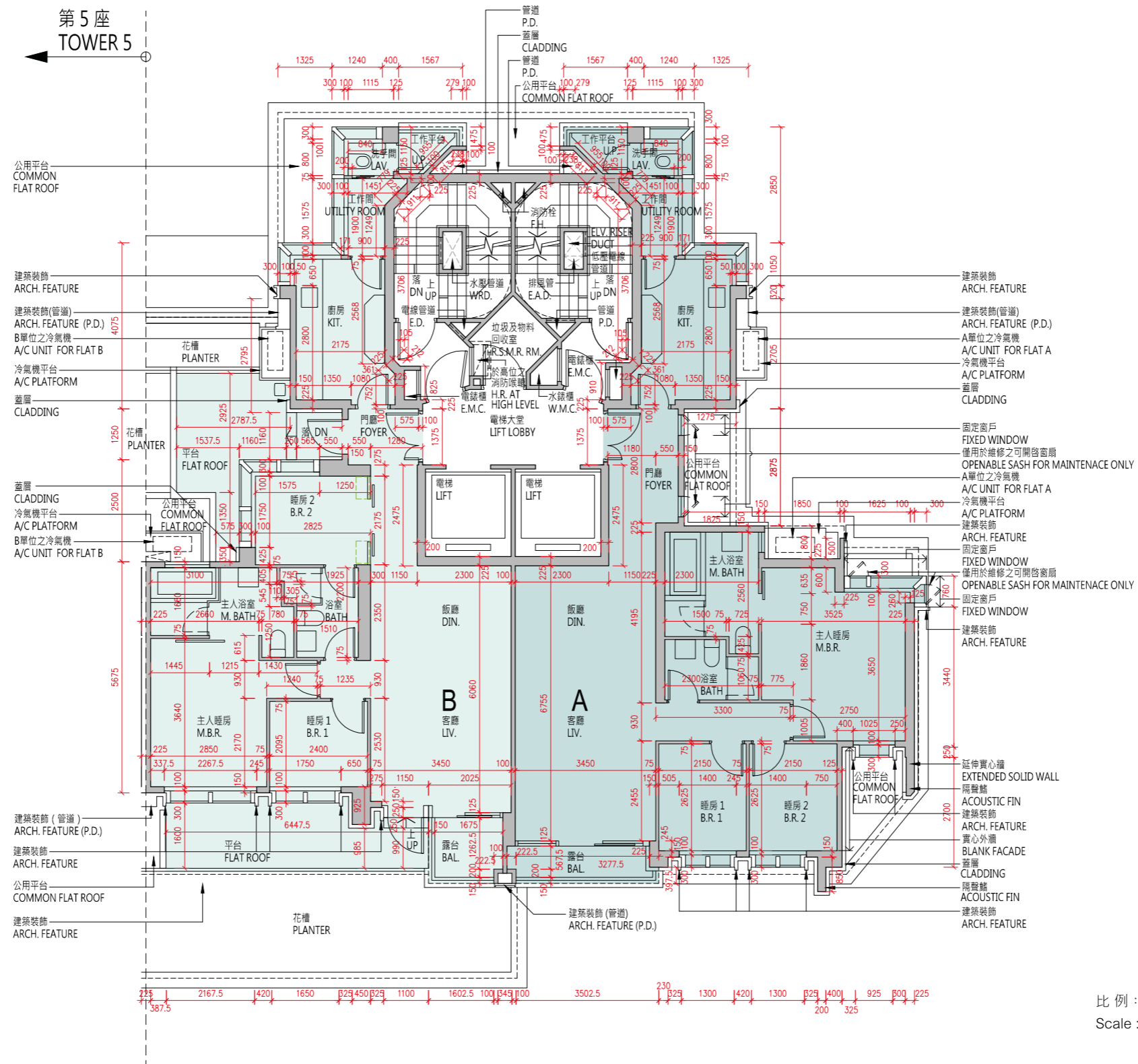

比例：0米/M
Scale : 0 5 10 15 20 25 30 35 40 45 50 55 60 65 70 75 80 85 90 95 100 105 110 115 120 125 130 135 140 145 150 155 160 165 170 175 180 185 190 195 200 205 210 215 220 225 230 235 240 245 250 255 260 265 270 275 280 285 290 295 300 305 310 315 320 325 330 335 340 345 350 355 360 365 370 375 380 385 390 395 400 405 410 415 420 425 430 435 440 445 450 455 460 465 470 475 480 485 490 495 500 505 510 515 520 525 530 535 540 545 550 555 560 565 570 575 580 585 590 595 600 605 610 615 620 625 630 635 640 645 650 655 660 665 670 675 680 685 690 695 700 705 710 715 720 725 730 735 740 745 750 755 760 765 770 775 780 785 790 795 800 805 810 815 820 825 830 835 840 845 850 855 860 865 870 875 880 885 890 895 900 905 910 915 920 925 930 935 940 945 950 955 960 965 970 975 980 985 990 995 1000

每個住宅物業 Each Residential Property	單位 Flat		
	樓層 Floor	A	B
層與層之間的高度 (毫米) Floor to Floor Height (mm)	1 樓 1/F	3450	3450
樓板 (不包括灰泥) 的厚度 (毫米) Thickness of Floor Slab (excluding plaster) (mm)	1/F	150, 200	150, 200

10 發展項目的住宅物業的樓面平面圖

FLOOR PLANS OF RESIDENTIAL PROPERTIES IN THE DEVELOPMENT

備註：

- (1) 批地文件特別條件第 8(d) 條規定：-
「(d) 在該地段已建成或擬建的住宅單位數目須不少於 515，並就本 (d) 分條而言：
 - (i) 一座擬作為單一家庭住宅的獨立屋、半獨立屋或排屋均被視為一個住宅單位；
 - (ii) 署長就獨立屋、半獨立屋或排屋是否構成或擬作為單一家庭住宅所作的決定將為最終決定，並對買方構成約束力；及
 - (iii) 署長就什麼構成一個住宅單位所作的決定將為最終決定，並對買方構成約束力。」
- (2) 公契及管理協議第 85 條規定：-
「管理人須在管理處備存一份由地政總署署長或任何其他不時替代其位的政府主管當局根據本公契附表三第 43 條所發出的同意的資料記錄，以供所有業主免費查閱及自費影印該資料記錄，並繳付合理費用。所有就此收取的費用一律撥入特別基金。」
- (3) 公契及管理協議附表三第 43 條規定：-
「43. 除非事先獲得地政總署署長或任何其他不時替代其位的政府主管當局的書面同意，否則任何業主不得進行或允許或容忍他人進行任何與住宅單位相關而可導致該住宅單位內部相連及通往任何毗連或毗鄰的住宅單位的工程，包括但不限於拆卸或更改任何分隔牆或任何樓板或天台樓板或任何間隔結構。而地政總署署長具有全權酌情給予同意或拒絕同意，倘若給予同意，業主須遵從地政總署署長按其全權酌情附加的任何條款及條件（包括支付費用）。」
- (4) 發展項目內所提供的住宅單位總數目為 590。
- (5) 平面圖所列的數字為以毫米標示之建築結構尺寸。
- (6) 因住宅物業的較高樓層的結構牆的厚度遞減，較高樓層的內部面積，一般比較低樓層的內部面積稍大。
- (7) 請參閱本售樓說明書第 20 頁為住宅物業樓面平面圖而設之備註及名詞及簡稱的圖例。

Notes:

- (1) Special Condition No. (8)(d) of the Land Grant stipulates that: -
“(d) the total number of residential units erected or to be erected on the lot shall not be less than 515, and for the purposes of this sub-clause (d):
 - (i) a detached, semi-detached or terraced house which is intended for use as a single family residence shall be regarded as a residential unit;
 - (ii) the decision of the Director as to whether a detached, semi-detached or terraced house constitutes or is intended for use as a single family residence shall be final and binding on the Purchaser; and
 - (iii) the decision of the Director as to what constitutes a residential unit shall be final and binding on the Purchaser.”
- (2) Clause 85 of the Deed of Mutual Covenant incorporating Management Agreement stipulates that: -
“85. The Manager shall deposit in the management office the record provided by the Director of Lands or any other Government authority in place of him from time to time of the information relating to the consent given under Clause 43 of the Third Schedule hereto for inspection by all Owners free of charge and taking copies at their own expense and on payment of a reasonable charge. All charges received shall be credited to the Special Fund.”
- (3) Clause 43 of the Third Schedule to the Deed of Mutual Covenant incorporating Management Agreement stipulates that: -
“43. No Owner shall carry out or permit or suffer to be carried out any works in connection with any Residential Unit, including but not limited to demolition or alteration of any partition wall or any floor or roof slab or any partition structure, which will result in such Residential Unit being internally linked to and accessible from any adjoining or adjacent Residential Unit, except with the prior written consent of the Director of Lands or any other Government authority in place of him from time to time, which consent may be given or withheld at his absolute discretion and if given, may be subject to such terms and conditions (including payment of fees) as may be imposed by him at his absolute discretion.”
- (4) The total number of residential units provided in the development is 590.
- (5) The dimensions in floor plans are all structural dimensions in millimeter.
- (6) The internal areas of the residential properties on the upper floors will generally be slightly larger than those on the lower floors because of the reducing thickness of the structural walls on the upper floors.
- (7) Please refer to page 20 of this sales brochure for the remarks and legends of the terms and abbreviations for the floor plans of residential properties.

10 發展項目的住宅物業的樓面平面圖 FLOOR PLANS OF RESIDENTIAL PROPERTIES IN THE DEVELOPMENT

第6座 2樓至3樓、5樓至12樓、15樓至23樓、
25樓至27樓平面圖

Tower 6 2/F-3/F, 5/F-12/F, 15/F-23/F,
25/F-27/F Floor Plan

第5座
TOWER 5

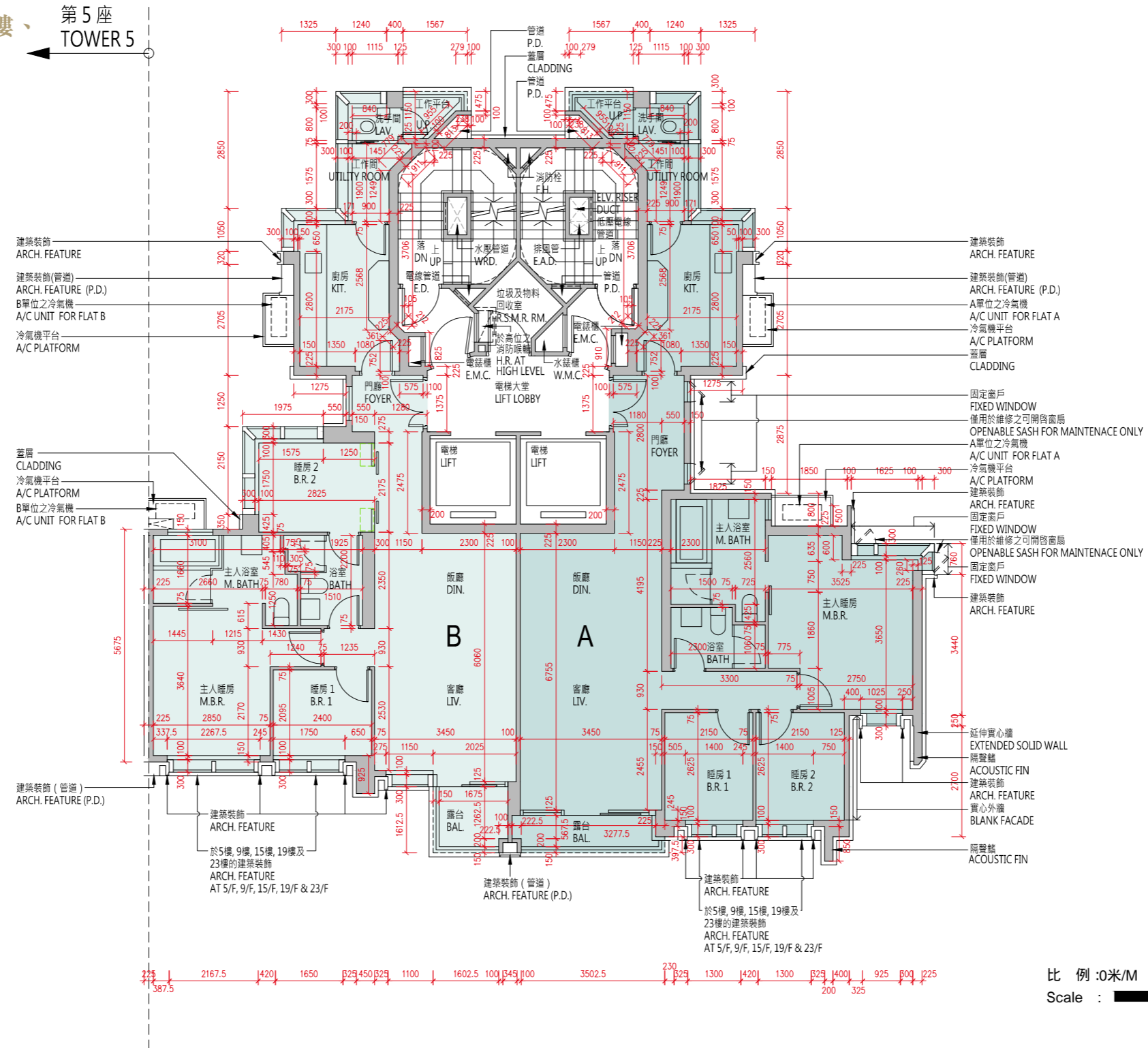

每個住宅物業 Each Residential Property	單位 Flat	
	樓層 Floor	
層與層之間的高度 (毫米) Floor to Floor Height (mm)	2樓至3樓、5樓至12樓、 15樓至23樓、25樓至26樓	A 3450 B 3450
樓板 (不包括灰泥) 的厚度 (毫米) Thickness of Floor Slab (excluding plaster) (mm)	2/F-3/F, 5/F-12/F, 15/F-23/F, 25/F-26/F	A 150, 200 B 150, 200

每個住宅物業 Each Residential Property	單位 Flat	
	樓層 Floor	
層與層之間的高度 (毫米) Floor to Floor Height (mm)	27 樓	A 3400, 3500 B 3150, 3180, 3400, 3470, 3500
樓板 (不包括灰泥) 的厚度 (毫米) Thickness of Floor Slab (excluding plaster) (mm)	27/F	A 150, 200, 250 B 150, 250

10 發展項目的住宅物業的樓面平面圖

FLOOR PLANS OF RESIDENTIAL PROPERTIES IN THE DEVELOPMENT

備註：

- (1) 批地文件特別條件第 8(d) 條規定：-
「(d) 在該地段已建成或擬建的住宅單位數目須不少於 515，並就本 (d) 分條而言：
 - (i) 一座擬作為單一家庭住宅的獨立屋、半獨立屋或排屋均被視為一個住宅單位；
 - (ii) 署長就獨立屋、半獨立屋或排屋是否構成或擬作為單一家庭住宅所作的決定將為最終決定，並對買方構成約束力；及
 - (iii) 署長就什麼構成一個住宅單位所作的決定將為最終決定，並對買方構成約束力。」
- (2) 公契及管理協議第 85 條規定：-
「管理人須在管理處備存一份由地政總署署長或任何其他不時替代其位的政府主管當局根據本公契附表三第 43 條所發出的同意的資料記錄，以供所有業主免費查閱及自費影印該資料記錄，並繳付合理費用。所有就此收取的費用一律撥入特別基金。」
- (3) 公契及管理協議附表三第 43 條規定：-
「43. 除非事先獲得地政總署署長或任何其他不時替代其位的政府主管當局的書面同意，否則任何業主不得進行或允許或容忍他人進行任何與住宅單位相關而可導致該住宅單位內部相連及通往任何毗連或毗鄰的住宅單位的工程，包括但不限於拆卸或更改任何分隔牆或任何樓板或天台樓板或任何間隔結構。而地政總署署長具有全權酌情給予同意或拒絕同意，倘若給予同意，業主須遵從地政總署署長按其全權酌情附加的任何條款及條件（包括支付費用）。」
- (4) 發展項目內所提供的住宅單位總數目為 590。
- (5) 平面圖所列的數字為以毫米標示之建築結構尺寸。
- (6) 因住宅物業的較高樓層的結構牆的厚度遞減，較高樓層的內部面積，一般比較低樓層的內部面積稍大。
- (7) 請參閱本售樓說明書第 20 頁為住宅物業樓面平面圖而設之備註及名詞及簡稱的圖例。

Notes:

- (1) Special Condition No. (8)(d) of the Land Grant stipulates that: -
“(d) the total number of residential units erected or to be erected on the lot shall not be less than 515, and for the purposes of this sub-clause (d):
 - (i) a detached, semi-detached or terraced house which is intended for use as a single family residence shall be regarded as a residential unit;
 - (ii) the decision of the Director as to whether a detached, semi-detached or terraced house constitutes or is intended for use as a single family residence shall be final and binding on the Purchaser; and
 - (iii) the decision of the Director as to what constitutes a residential unit shall be final and binding on the Purchaser.”
- (2) Clause 85 of the Deed of Mutual Covenant incorporating Management Agreement stipulates that: -
“85. The Manager shall deposit in the management office the record provided by the Director of Lands or any other Government authority in place of him from time to time of the information relating to the consent given under Clause 43 of the Third Schedule hereto for inspection by all Owners free of charge and taking copies at their own expense and on payment of a reasonable charge. All charges received shall be credited to the Special Fund.”
- (3) Clause 43 of the Third Schedule to the Deed of Mutual Covenant incorporating Management Agreement stipulates that: -
“43. No Owner shall carry out or permit or suffer to be carried out any works in connection with any Residential Unit, including but not limited to demolition or alteration of any partition wall or any floor or roof slab or any partition structure, which will result in such Residential Unit being internally linked to and accessible from any adjoining or adjacent Residential Unit, except with the prior written consent of the Director of Lands or any other Government authority in place of him from time to time, which consent may be given or withheld at his absolute discretion and if given, may be subject to such terms and conditions (including payment of fees) as may be imposed by him at his absolute discretion.”
- (4) The total number of residential units provided in the development is 590.
- (5) The dimensions in floor plans are all structural dimensions in millimeter.
- (6) The internal areas of the residential properties on the upper floors will generally be slightly larger than those on the lower floors because of the reducing thickness of the structural walls on the upper floors.
- (7) Please refer to page 20 of this sales brochure for the remarks and legends of the terms and abbreviations for the floor plans of residential properties.

第6座 28樓平面圖
Tower 6 28/F Floor Plan

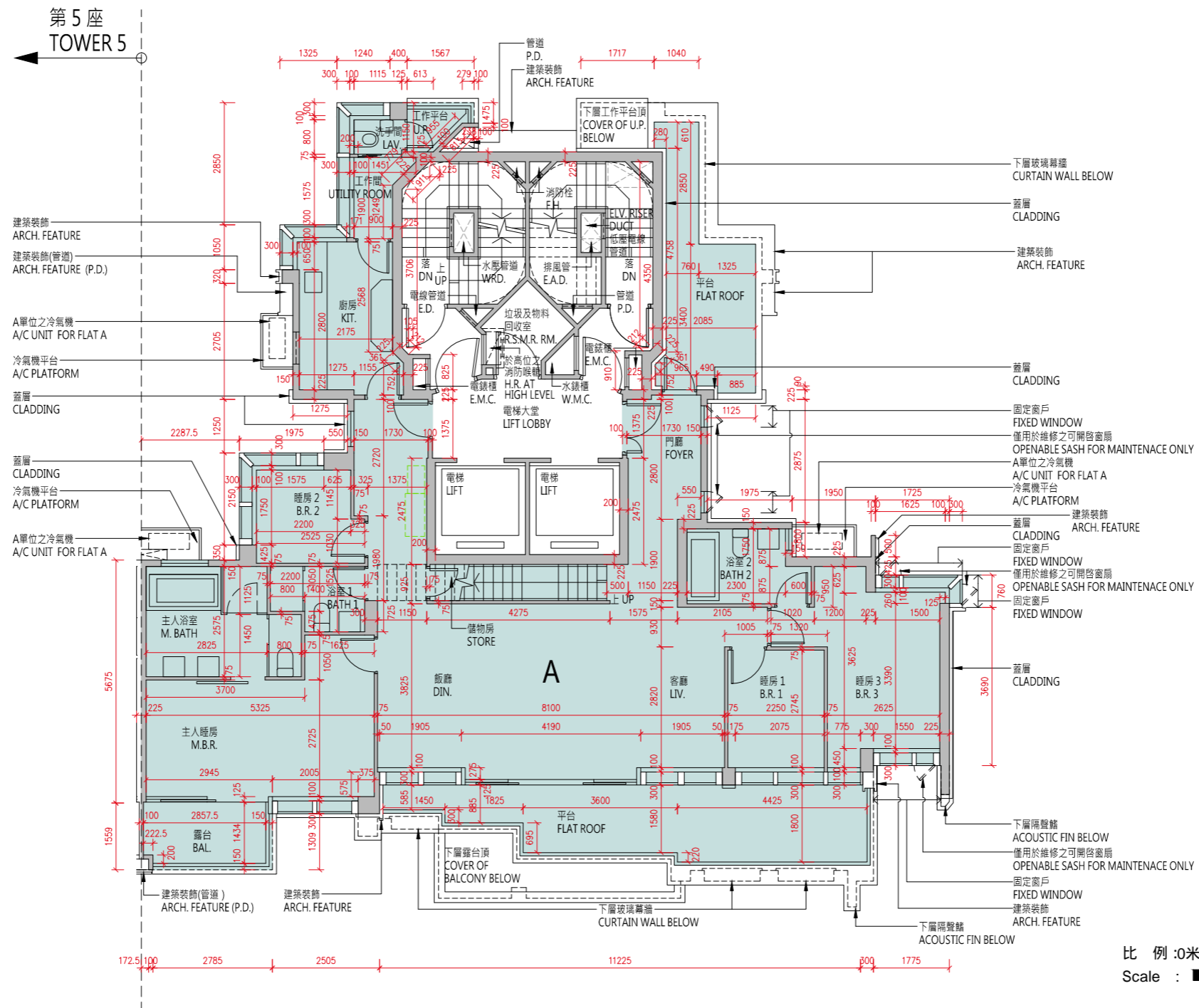
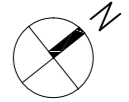

樓層 Floor	28樓 28 / F
層與層之間的高度 (毫米) Floor to Floor Height (mm)	3500
樓板 (不包括灰泥) 的厚度 (毫米) Thickness of Floor Slab (excluding plaster) (mm)	150, 200

10 發展項目的住宅物業的樓面平面圖

FLOOR PLANS OF RESIDENTIAL PROPERTIES IN THE DEVELOPMENT

備註：

- (1) 批地文件特別條件第 8(d) 條規定：-
「(d) 在該地段已建成或擬建的住宅單位數目須不少於 515，並就本 (d) 分條而言：
 - (i) 一座擬作為單一家庭住宅的獨立屋、半獨立屋或排屋均被視為一個住宅單位；
 - (ii) 署長就獨立屋、半獨立屋或排屋是否構成或擬作為單一家庭住宅所作的決定將為最終決定，並對買方構成約束力；及
 - (iii) 署長就什麼構成一個住宅單位所作的決定將為最終決定，並對買方構成約束力。」
- (2) 公契及管理協議第 85 條規定：-
「管理人須在管理處備存一份由地政總署署長或任何其他不時替代其位的政府主管當局根據本公契附表三第 43 條所發出的同意的資料記錄，以供所有業主免費查閱及自費影印該資料記錄，並繳付合理費用。所有就此收取的費用一律撥入特別基金。」
- (3) 公契及管理協議附表三第 43 條規定：-
「43. 除非事先獲得地政總署署長或任何其他不時替代其位的政府主管當局的書面同意，否則任何業主不得進行或允許或容忍他人進行任何與住宅單位相關而可導致該住宅單位內部相連及通往任何毗連或毗鄰的住宅單位的工程，包括但不限於拆卸或更改任何分隔牆或任何樓板或天台樓板或任何間隔結構。而地政總署署長具有全權酌情給予同意或拒絕同意，倘若給予同意，業主須遵從地政總署署長按其全權酌情附加的任何條款及條件（包括支付費用）。」
- (4) 發展項目內所提供的住宅單位總數目為 590。
- (5) 平面圖所列的數字為以毫米標示之建築結構尺寸。
- (6) 因住宅物業的較高樓層的結構牆的厚度遞減，較高樓層的內部面積，一般比較低樓層的內部面積稍大。
- (7) 請參閱本售樓說明書第 20 頁為住宅物業樓面平面圖而設之備註及名詞及簡稱的圖例。

Notes:

- (1) Special Condition No. (8)(d) of the Land Grant stipulates that: -
“(d) the total number of residential units erected or to be erected on the lot shall not be less than 515, and for the purposes of this sub-clause (d):
 - (i) a detached, semi-detached or terraced house which is intended for use as a single family residence shall be regarded as a residential unit;
 - (ii) the decision of the Director as to whether a detached, semi-detached or terraced house constitutes or is intended for use as a single family residence shall be final and binding on the Purchaser; and
 - (iii) the decision of the Director as to what constitutes a residential unit shall be final and binding on the Purchaser.”
- (2) Clause 85 of the Deed of Mutual Covenant incorporating Management Agreement stipulates that: -
“85. The Manager shall deposit in the management office the record provided by the Director of Lands or any other Government authority in place of him from time to time of the information relating to the consent given under Clause 43 of the Third Schedule hereto for inspection by all Owners free of charge and taking copies at their own expense and on payment of a reasonable charge. All charges received shall be credited to the Special Fund.”
- (3) Clause 43 of the Third Schedule to the Deed of Mutual Covenant incorporating Management Agreement stipulates that: -
“43. No Owner shall carry out or permit or suffer to be carried out any works in connection with any Residential Unit, including but not limited to demolition or alteration of any partition wall or any floor or roof slab or any partition structure, which will result in such Residential Unit being internally linked to and accessible from any adjoining or adjacent Residential Unit, except with the prior written consent of the Director of Lands or any other Government authority in place of him from time to time, which consent may be given or withheld at his absolute discretion and if given, may be subject to such terms and conditions (including payment of fees) as may be imposed by him at his absolute discretion.”
- (4) The total number of residential units provided in the development is 590.
- (5) The dimensions in floor plans are all structural dimensions in millimeter.
- (6) The internal areas of the residential properties on the upper floors will generally be slightly larger than those on the lower floors because of the reducing thickness of the structural walls on the upper floors.
- (7) Please refer to page 20 of this sales brochure for the remarks and legends of the terms and abbreviations for the floor plans of residential properties.

第6座 天台平面圖
Tower 6 Roof Floor Plan

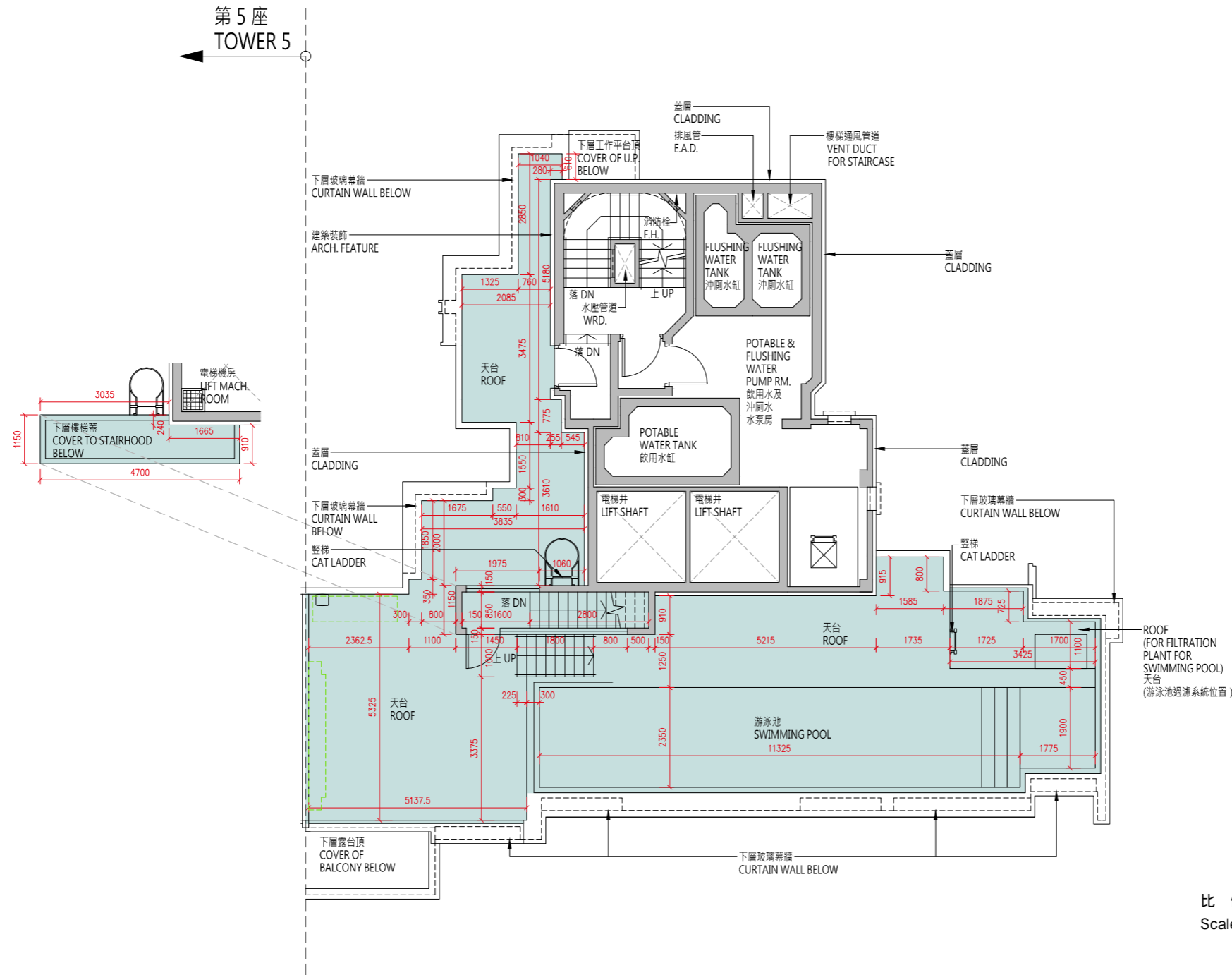
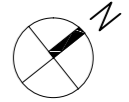

比例 : 0米/M 5米/M
Scale :

樓層 Floor	天台 Roof
層與層之間的高度 (毫米) Floor to Floor Height (mm)	N/A
樓板 (不包括灰泥) 的厚度 (毫米) Thickness of Floor Slab (excluding plaster) (mm)	N/A

10 發展項目的住宅物業的樓面平面圖

FLOOR PLANS OF RESIDENTIAL PROPERTIES IN THE DEVELOPMENT

備註：

- (1) 批地文件特別條件第 8(d) 條規定：-
「(d) 在該地段已建成或擬建的住宅單位數目須不少於 515，並就本 (d) 分條而言：
 - (i) 一座擬作為單一家庭住宅的獨立屋、半獨立屋或排屋均被視為一個住宅單位；
 - (ii) 署長就獨立屋、半獨立屋或排屋是否構成或擬作為單一家庭住宅所作的決定將為最終決定，並對買方構成約束力；及
 - (iii) 署長就什麼構成一個住宅單位所作的決定將為最終決定，並對買方構成約束力。」
- (2) 公契及管理協議第 85 條規定：-
「管理人須在管理處備存一份由地政總署署長或任何其他不時替代其位的政府主管當局根據本公契附表三第 43 條所發出的同意的資料記錄，以供所有業主免費查閱及自費影印該資料記錄，並繳付合理費用。所有就此收取的費用一律撥入特別基金。」
- (3) 公契及管理協議附表三第 43 條規定：-
「43. 除非事先獲得地政總署署長或任何其他不時替代其位的政府主管當局的書面同意，否則任何業主不得進行或允許或容忍他人進行任何與住宅單位相關而可導致該住宅單位內部相連及通往任何毗連或毗鄰的住宅單位的工程，包括但不限於拆卸或更改任何分隔牆或任何樓板或天台樓板或任何間隔結構。而地政總署署長具有全權酌情給予同意或拒絕同意，倘若給予同意，業主須遵從地政總署署長按其全權酌情附加的任何條款及條件（包括支付費用）。」
- (4) 發展項目內所提供的住宅單位總數目為 590。
- (5) 平面圖所列的數字為以毫米標示之建築結構尺寸。
- (6) 因住宅物業的較高樓層的結構牆的厚度遞減，較高樓層的內部面積，一般比較低樓層的內部面積稍大。
- (7) 請參閱本售樓說明書第 20 頁為住宅物業樓面平面圖而設之備註及名詞及簡稱的圖例。

Notes:

- (1) Special Condition No. (8)(d) of the Land Grant stipulates that: -
“(d) the total number of residential units erected or to be erected on the lot shall not be less than 515, and for the purposes of this sub-clause (d):
 - (i) a detached, semi-detached or terraced house which is intended for use as a single family residence shall be regarded as a residential unit;
 - (ii) the decision of the Director as to whether a detached, semi-detached or terraced house constitutes or is intended for use as a single family residence shall be final and binding on the Purchaser; and
 - (iii) the decision of the Director as to what constitutes a residential unit shall be final and binding on the Purchaser.”
- (2) Clause 85 of the Deed of Mutual Covenant incorporating Management Agreement stipulates that: -
“85. The Manager shall deposit in the management office the record provided by the Director of Lands or any other Government authority in place of him from time to time of the information relating to the consent given under Clause 43 of the Third Schedule hereto for inspection by all Owners free of charge and taking copies at their own expense and on payment of a reasonable charge. All charges received shall be credited to the Special Fund.”
- (3) Clause 43 of the Third Schedule to the Deed of Mutual Covenant incorporating Management Agreement stipulates that: -
“43. No Owner shall carry out or permit or suffer to be carried out any works in connection with any Residential Unit, including but not limited to demolition or alteration of any partition wall or any floor or roof slab or any partition structure, which will result in such Residential Unit being internally linked to and accessible from any adjoining or adjacent Residential Unit, except with the prior written consent of the Director of Lands or any other Government authority in place of him from time to time, which consent may be given or withheld at his absolute discretion and if given, may be subject to such terms and conditions (including payment of fees) as may be imposed by him at his absolute discretion.”
- (4) The total number of residential units provided in the development is 590.
- (5) The dimensions in floor plans are all structural dimensions in millimeter.
- (6) The internal areas of the residential properties on the upper floors will generally be slightly larger than those on the lower floors because of the reducing thickness of the structural walls on the upper floors.
- (7) Please refer to page 20 of this sales brochure for the remarks and legends of the terms and abbreviations for the floor plans of residential properties.

第7座 1樓平面圖
Tower 7 1/F Floor Plan

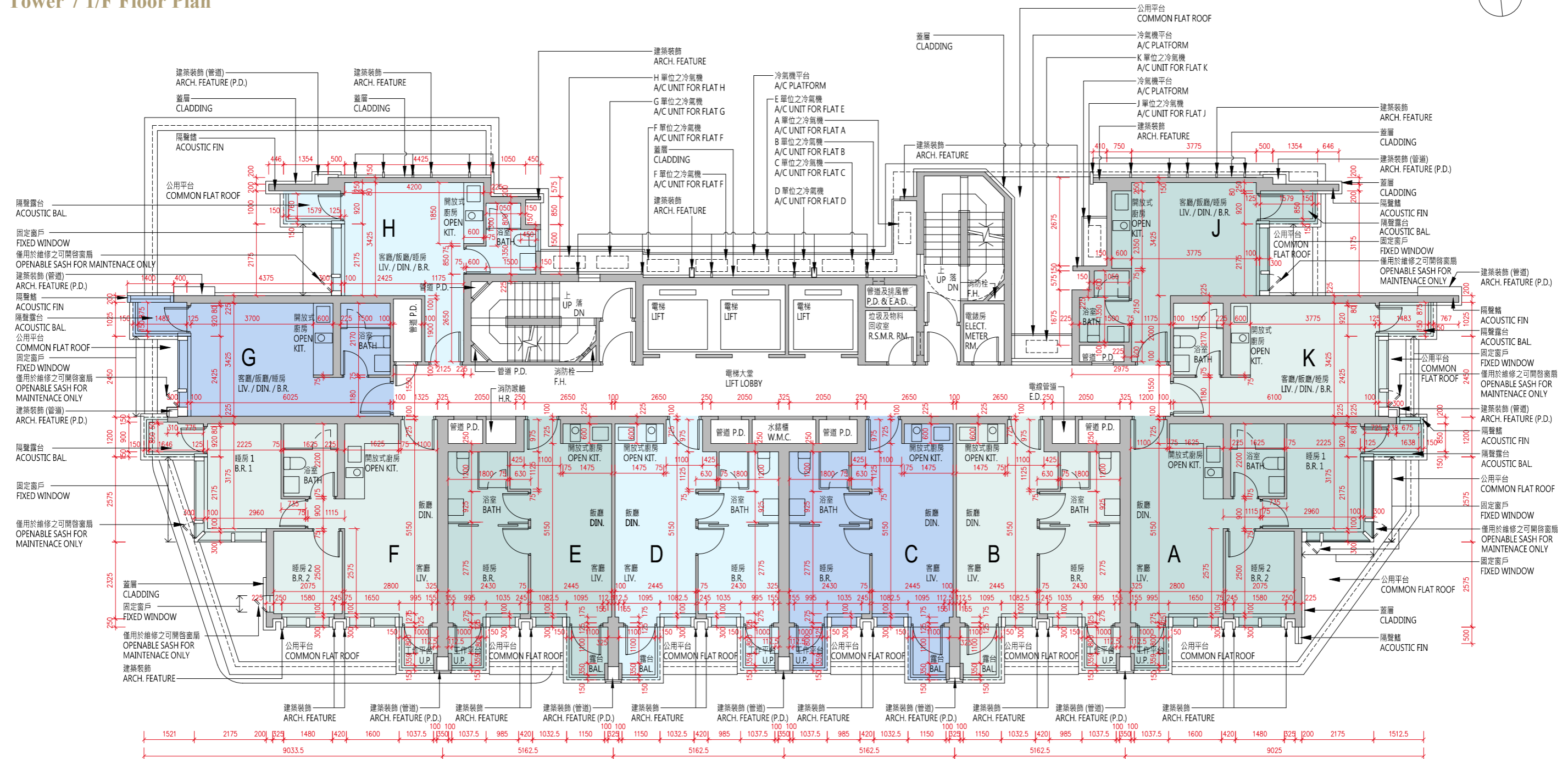
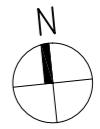

比例 :0米/M 5米/M
Scale :

每個住宅物業 Each Residential Property	單位 Flat		A	B	C	D	E	F	G	H	J	K
	樓層 Floor											
層與層之間的高度 (毫米) Floor to Floor Height (mm)	1樓		3450	3450	3450	3450	3450	3450	3450	3450	3450	3450
樓板 (不包括灰泥) 的厚度 (毫米) Thickness of Floor Slab (excluding plaster) (mm)	1/F		200	200	200	200	200	200	150	150	150	150

10 發展項目的住宅物業的樓面平面圖

FLOOR PLANS OF RESIDENTIAL PROPERTIES IN THE DEVELOPMENT

備註：

- (1) 批地文件特別條件第 8(d) 條規定：-
「(d) 在該地段已建成或擬建的住宅單位數目須不少於 515，並就本 (d) 分條而言：
 - (i) 一座擬作為單一家庭住宅的獨立屋、半獨立屋或排屋均被視為一個住宅單位；
 - (ii) 署長就獨立屋、半獨立屋或排屋是否構成或擬作為單一家庭住宅所作的決定將為最終決定，並對買方構成約束力；及
 - (iii) 署長就什麼構成一個住宅單位所作的決定將為最終決定，並對買方構成約束力。」
- (2) 公契及管理協議第 85 條規定：-
「管理人須在管理處備存一份由地政總署署長或任何其他不時替代其位的政府主管當局根據本公契附表三第 43 條所發出的同意的資料記錄，以供所有業主免費查閱及自費影印該資料記錄，並繳付合理費用。所有就此收取的費用一律撥入特別基金。」
- (3) 公契及管理協議附表三第 43 條規定：-
「43. 除非事先獲得地政總署署長或任何其他不時替代其位的政府主管當局的書面同意，否則任何業主不得進行或允許或容忍他人進行任何與住宅單位相關而可導致該住宅單位內部相連及通往任何毗連或毗鄰的住宅單位的工程，包括但不限於拆卸或更改任何分隔牆或任何樓板或天台樓板或任何間隔結構。而地政總署署長具有全權酌情給予同意或拒絕同意，倘若給予同意，業主須遵從地政總署署長按其全權酌情附加的任何條款及條件（包括支付費用）。」
- (4) 發展項目內所提供的住宅單位總數目為 590。
- (5) 平面圖所列的數字為以毫米標示之建築結構尺寸。
- (6) 因住宅物業的較高樓層的結構牆的厚度遞減，較高樓層的內部面積，一般比較低樓層的內部面積稍大。
- (7) 請參閱本售樓說明書第 20 頁為住宅物業樓面平面圖而設之備註及名詞及簡稱的圖例。

Notes:

- (1) Special Condition No. (8)(d) of the Land Grant stipulates that: -
“(d) the total number of residential units erected or to be erected on the lot shall not be less than 515, and for the purposes of this sub-clause (d):
 - (i) a detached, semi-detached or terraced house which is intended for use as a single family residence shall be regarded as a residential unit;
 - (ii) the decision of the Director as to whether a detached, semi-detached or terraced house constitutes or is intended for use as a single family residence shall be final and binding on the Purchaser; and
 - (iii) the decision of the Director as to what constitutes a residential unit shall be final and binding on the Purchaser.”
- (2) Clause 85 of the Deed of Mutual Covenant incorporating Management Agreement stipulates that: -
“85. The Manager shall deposit in the management office the record provided by the Director of Lands or any other Government authority in place of him from time to time of the information relating to the consent given under Clause 43 of the Third Schedule hereto for inspection by all Owners free of charge and taking copies at their own expense and on payment of a reasonable charge. All charges received shall be credited to the Special Fund.”
- (3) Clause 43 of the Third Schedule to the Deed of Mutual Covenant incorporating Management Agreement stipulates that: -
“43. No Owner shall carry out or permit or suffer to be carried out any works in connection with any Residential Unit, including but not limited to demolition or alteration of any partition wall or any floor or roof slab or any partition structure, which will result in such Residential Unit being internally linked to and accessible from any adjoining or adjacent Residential Unit, except with the prior written consent of the Director of Lands or any other Government authority in place of him from time to time, which consent may be given or withheld at his absolute discretion and if given, may be subject to such terms and conditions (including payment of fees) as may be imposed by him at his absolute discretion.”
- (4) The total number of residential units provided in the development is 590.
- (5) The dimensions in floor plans are all structural dimensions in millimeter.
- (6) The internal areas of the residential properties on the upper floors will generally be slightly larger than those on the lower floors because of the reducing thickness of the structural walls on the upper floors.
- (7) Please refer to page 20 of this sales brochure for the remarks and legends of the terms and abbreviations for the floor plans of residential properties.

10 發展項目的住宅物業的樓面平面圖 FLOOR PLANS OF RESIDENTIAL PROPERTIES IN THE DEVELOPMENT

第7座 2樓至3樓、5樓至11樓平面圖 Tower 7 2/F-3/F, 5/F-11/F Floor Plan

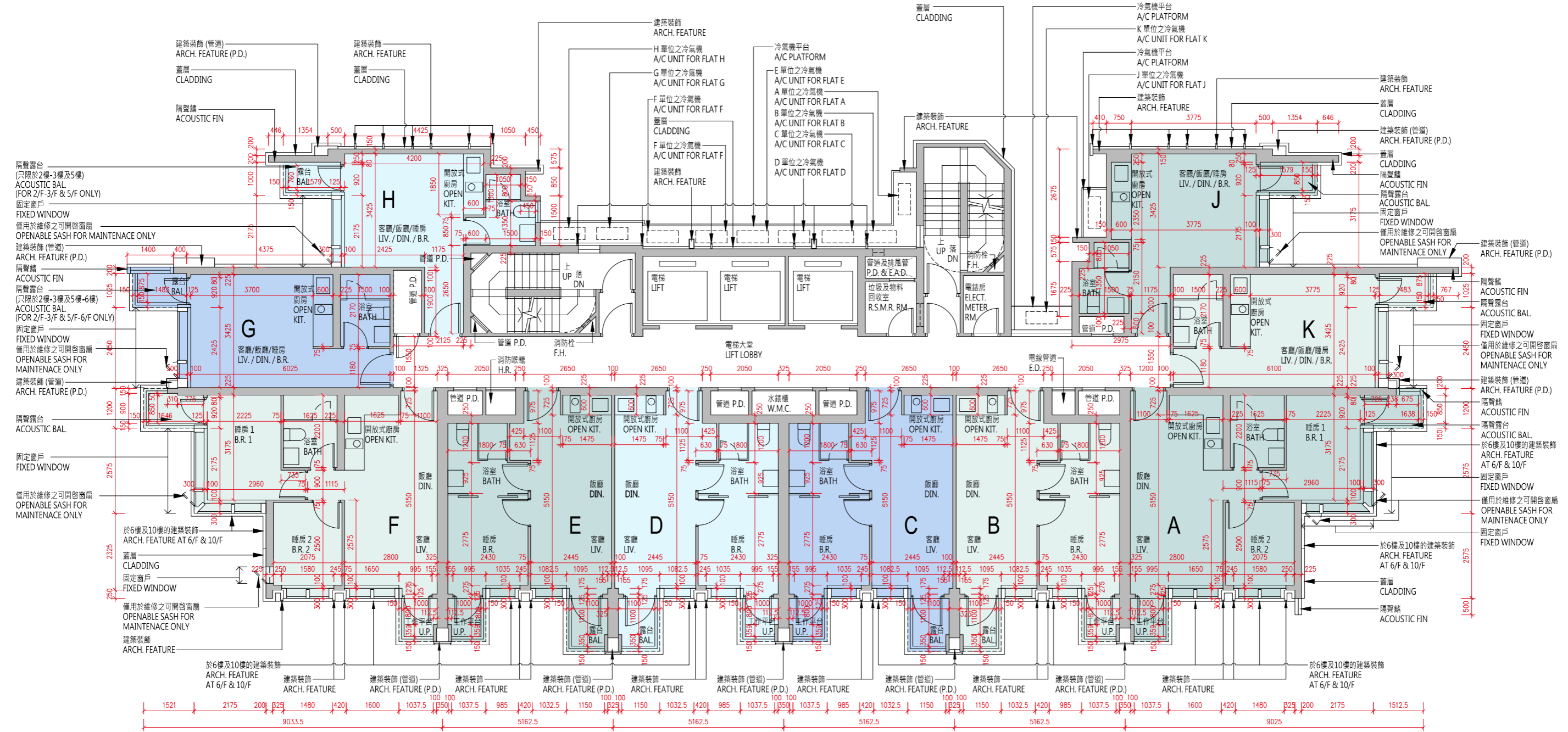
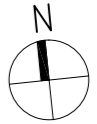

比例 : 0米/M
Scale : 5米/M

每個住宅物業 Each Residential Property	單位 Flat 樓層 Floor	A	B	C	D	E	F	G	H	J	K
		層與層之間的高度 (毫米) Floor to Floor Height (mm)	3450	3450	3450	3450	3450	3450	3450	3450	3450
樓板 (不包括灰泥) 的厚度 (毫米) Thickness of Floor Slab (excluding plaster) (mm)	2樓至3樓、 5樓至11樓 2/F-3/F, 5/F-11/F	200	200	200	200	200	200	150	150	150	150

10 發展項目的住宅物業的樓面平面圖

FLOOR PLANS OF RESIDENTIAL PROPERTIES IN THE DEVELOPMENT

備註：

- (1) 批地文件特別條件第 8(d) 條規定：-
「(d) 在該地段已建成或擬建的住宅單位數目須不少於 515，並就本 (d) 分條而言：
 - (i) 一座擬作為單一家庭住宅的獨立屋、半獨立屋或排屋均被視為一個住宅單位；
 - (ii) 署長就獨立屋、半獨立屋或排屋是否構成或擬作為單一家庭住宅所作的決定將為最終決定，並對買方構成約束力；及
 - (iii) 署長就什麼構成一個住宅單位所作的決定將為最終決定，並對買方構成約束力。」
- (2) 公契及管理協議第 85 條規定：-
「管理人須在管理處備存一份由地政總署署長或任何其他不時替代其位的政府主管當局根據本公契附表三第 43 條所發出的同意的資料記錄，以供所有業主免費查閱及自費影印該資料記錄，並繳付合理費用。所有就此收取的費用一律撥入特別基金。」
- (3) 公契及管理協議附表三第 43 條規定：-
「43. 除非事先獲得地政總署署長或任何其他不時替代其位的政府主管當局的書面同意，否則任何業主不得進行或允許或容忍他人進行任何與住宅單位相關而可導致該住宅單位內部相連及通往任何毗連或毗鄰的住宅單位的工程，包括但不限於拆卸或更改任何分隔牆或任何樓板或天台樓板或任何間隔結構。而地政總署署長具有全權酌情給予同意或拒絕同意，倘若給予同意，業主須遵從地政總署署長按其全權酌情附加的任何條款及條件（包括支付費用）。」
- (4) 發展項目內所提供的住宅單位總數目為 590。
- (5) 平面圖所列的數字為以毫米標示之建築結構尺寸。
- (6) 因住宅物業的較高樓層的結構牆的厚度遞減，較高樓層的內部面積，一般比較低樓層的內部面積稍大。
- (7) 請參閱本售樓說明書第 20 頁為住宅物業樓面平面圖而設之備註及名詞及簡稱的圖例。

Notes:

- (1) Special Condition No. (8)(d) of the Land Grant stipulates that: -
“(d) the total number of residential units erected or to be erected on the lot shall not be less than 515, and for the purposes of this sub-clause (d):
 - (i) a detached, semi-detached or terraced house which is intended for use as a single family residence shall be regarded as a residential unit;
 - (ii) the decision of the Director as to whether a detached, semi-detached or terraced house constitutes or is intended for use as a single family residence shall be final and binding on the Purchaser; and
 - (iii) the decision of the Director as to what constitutes a residential unit shall be final and binding on the Purchaser.”
- (2) Clause 85 of the Deed of Mutual Covenant incorporating Management Agreement stipulates that: -
“85. The Manager shall deposit in the management office the record provided by the Director of Lands or any other Government authority in place of him from time to time of the information relating to the consent given under Clause 43 of the Third Schedule hereto for inspection by all Owners free of charge and taking copies at their own expense and on payment of a reasonable charge. All charges received shall be credited to the Special Fund.”
- (3) Clause 43 of the Third Schedule to the Deed of Mutual Covenant incorporating Management Agreement stipulates that: -
“43. No Owner shall carry out or permit or suffer to be carried out any works in connection with any Residential Unit, including but not limited to demolition or alteration of any partition wall or any floor or roof slab or any partition structure, which will result in such Residential Unit being internally linked to and accessible from any adjoining or adjacent Residential Unit, except with the prior written consent of the Director of Lands or any other Government authority in place of him from time to time, which consent may be given or withheld at his absolute discretion and if given, may be subject to such terms and conditions (including payment of fees) as may be imposed by him at his absolute discretion.”
- (4) The total number of residential units provided in the development is 590.
- (5) The dimensions in floor plans are all structural dimensions in millimeter.
- (6) The internal areas of the residential properties on the upper floors will generally be slightly larger than those on the lower floors because of the reducing thickness of the structural walls on the upper floors.
- (7) Please refer to page 20 of this sales brochure for the remarks and legends of the terms and abbreviations for the floor plans of residential properties.

10 發展項目的住宅物業的樓面平面圖 FLOOR PLANS OF RESIDENTIAL PROPERTIES IN THE DEVELOPMENT

第7座 12樓、15樓至23樓、25樓至28樓平面圖 Tower 7 12/F, 15/F-23/F, 25/F-28/F Floor Plan

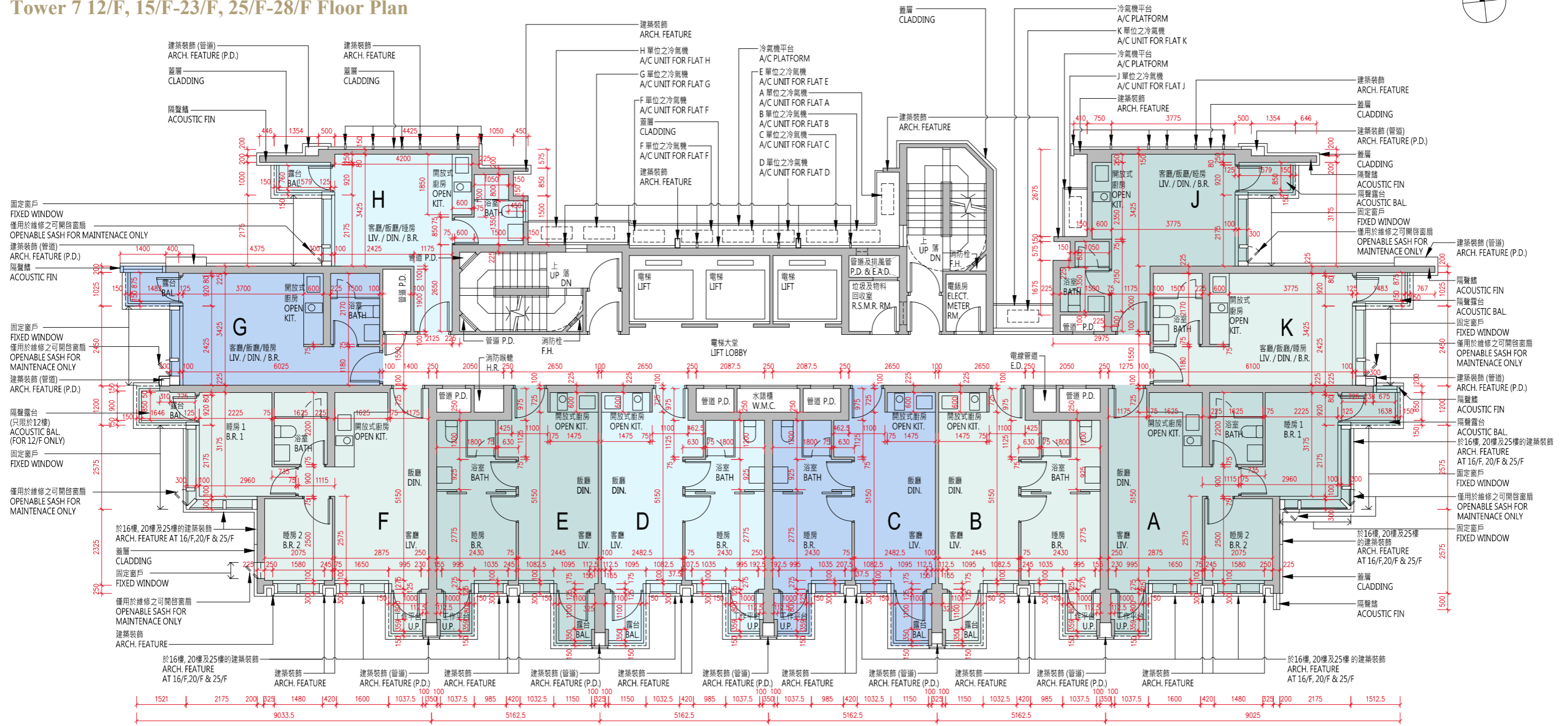
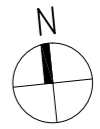

比例 : 0米/M 5米/M
Scale : 0 5

每個住宅物業 Each Residential Property	單位 Flat 樓層 Floor	單位 Flat										
		A	B	C	D	E	F	G	H	J	K	
層與層之間的高度 (毫米) Floor to Floor Height (mm)	12樓、15樓至23樓、25樓至27樓	3450	3450	3450	3450	3450	3450	3450	3450	3450	3450	3450
樓板 (不包括灰泥) 的厚度 (毫米) Thickness of Floor Slab (excluding plaster) (mm)	12/F, 15/F-23/F, 25/F-27/F	200	200	200	200	200	200	150	150	150	150	150

每個住宅物業 Each Residential Property	單位 Flat 樓層 Floor	單位 Flat										
		A	B	C	D	E	F	G	H	J	K	
層與層之間的高度 (毫米) Floor to Floor Height (mm)	28樓	3500	3500	3500	3500	3500	3500	3500	3500	3500	3500	3500
樓板 (不包括灰泥) 的厚度 (毫米) Thickness of Floor Slab (excluding plaster) (mm)	28/F	200	200	200	200	200	200	200	200	200	200	200